

NOTE 1 . All lead co-planarity shall be 0.08mm MAX.  
 2 . Contact plating specifications  
 Contact area : Gold 0.05μm MIN  
 SMT lead : Gold 0.05μm MIN  
 Under plating : Nickel 1μm MIN  
 (Surface : Sealing)  
 3 . HRS mark and CAV No. are indicated in approx. position shown.

4	COPPER ALLOY	2	8	PS	CLEAR. REINFORCEMENT COLLAR		
3	COPPER ALLOY	2	7	PS	BLACK. PLASTIC REEL		
2	COPPER ALLOY	2	6	POLYESTER	CLEAR. COVER TAPE		
1	LCP	UL94 V-0. BLACK	5	PS	CLEAR. EMBOSSED CARRIER TAPE		
NO.	MATERIAL	FINISH . REMARKS	NO.	MATERIAL	FINISH . REMARKS		
UNITS	mm	SCALE	COUNT	DESCRIPTION OF REVISIONS	DESIGNED	CHECKED	DATE
		10:1	1	DIS-H-00001218	TR. YUNOKI	TS. MIYAZAKI	15.12.26
APPROVED : MO. ISHIDA			15.02.26	DRAWING NO. EDC-358233-51-05			
CHECKED : YH. MICHIDA			15.02.26	PART NO. BM25-4S/2-V(51)			
DESIGNED : TR. YUNOKI			15.02.26	CODE NO. CL677-1200-0-51			
DRAWN : TR. YUNOKI			15.02.02	1/4			

◆ Recommended PCB layout

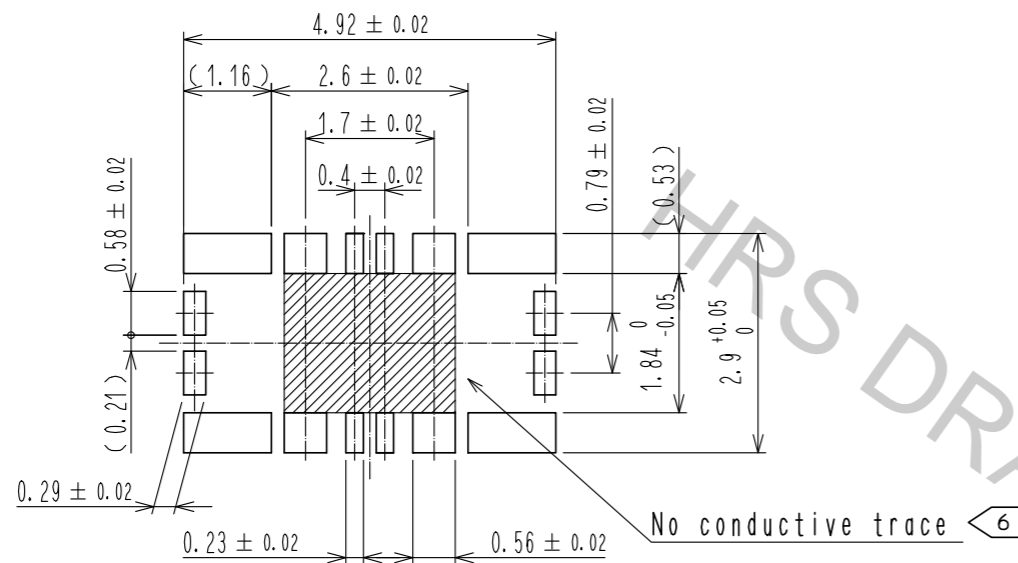

◆ Recommended metal mask dimensions  
Metal mask thickness :  $100 \mu\text{m}$   
(Open ratio : 100% for PCB layout)

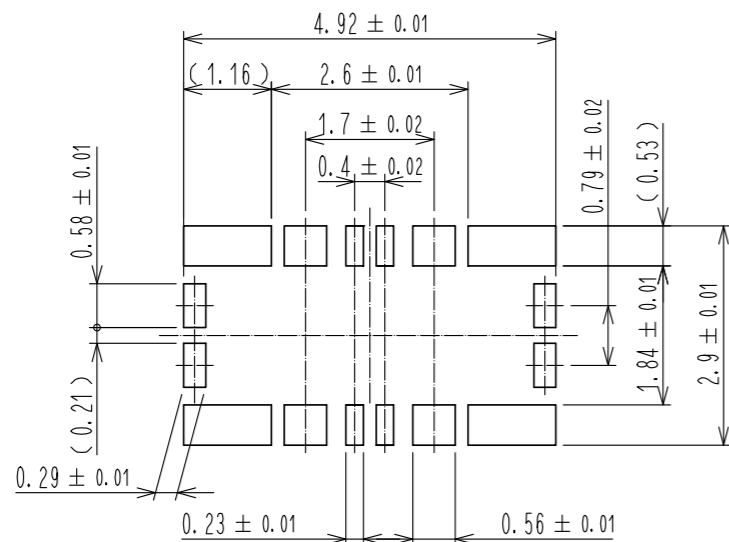

4 Recommended reflow temperature profile using lead-free solder paste.

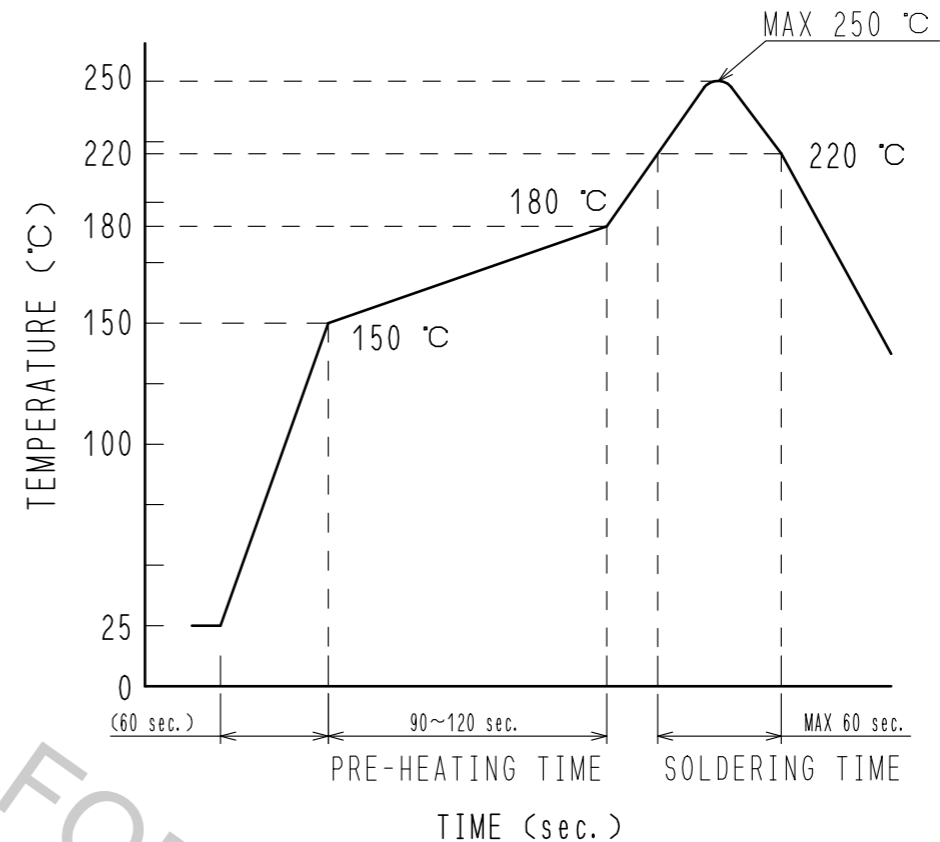

- 4 The temperatures mentioned above refer to the PCB surface temperature near the connector leads. The temperature profiles are based on the above conditions. In individual applications the actual temperature may vary, depending on solder paste type, volume/thickness and board size/thickness. Consult your solder paste and equipment manufacturer for specific recommendations.
- 5 Please contact us in case you will make different settings from our recommendation.
- 6 For the routing on the indicated PCB surface, apply solder resist in order for the insulation treatment.

<b>HRS</b>	DRAWING NO.	EDC-358233-51-05
	PART NO.	BM25-4S/2-V(51)
	CODE NO.	CL677-1200-0-51

### Embossed carrier tape packaging (5:1)

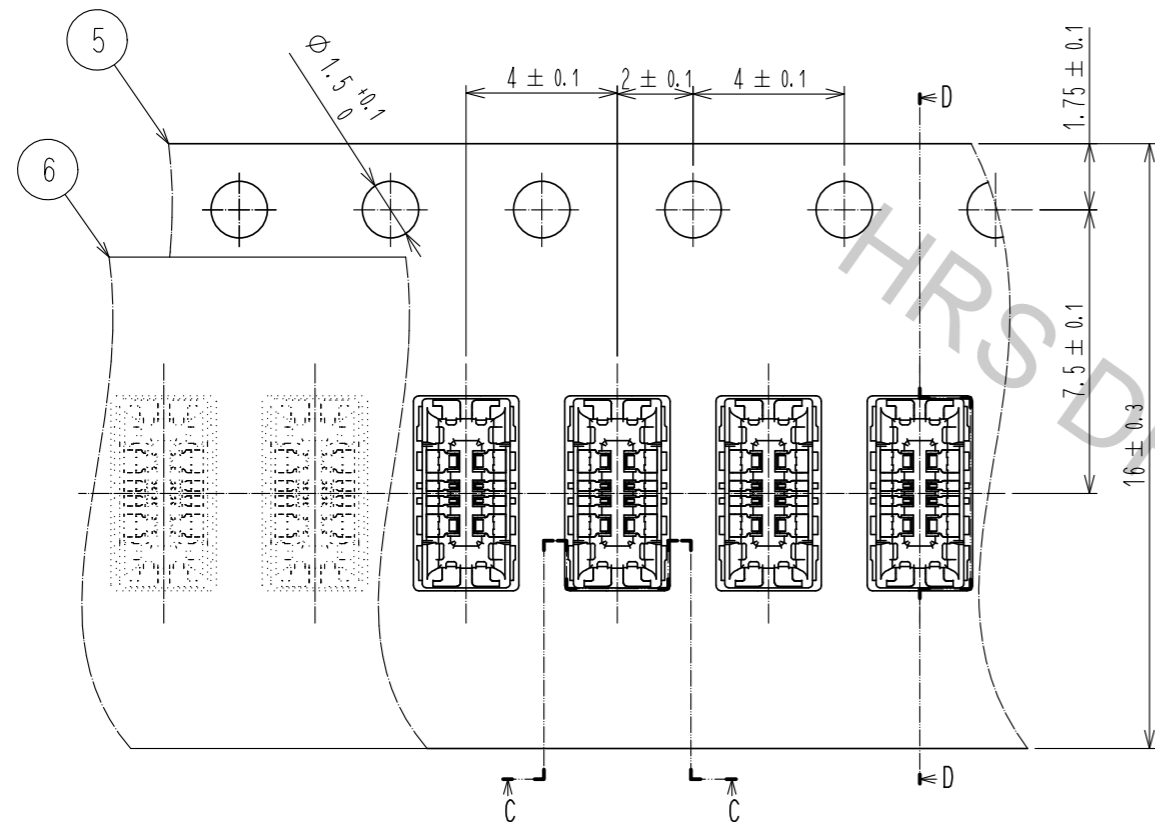

Direction of unreeling

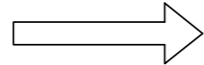

C-C (5:1)

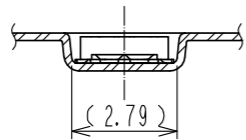

D-D (5:1)

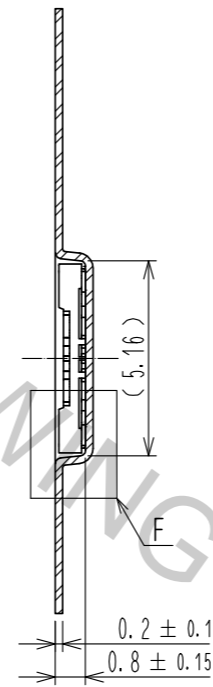

F (10:1)

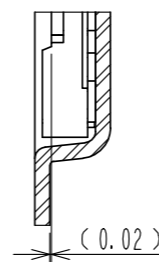

### Style and dimension of reel (Free)

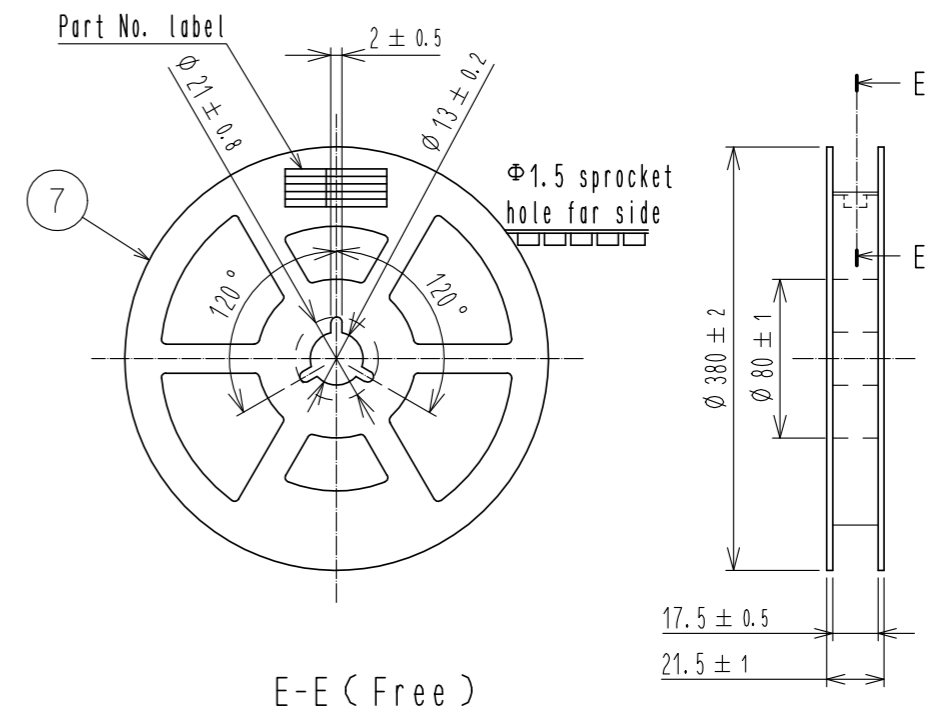

E-E (Free)

10 Reinforcement collar

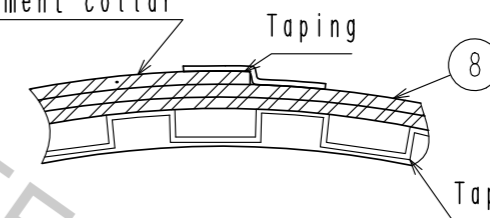

### Detail of part No. label

製造年月日	** ** *	Data of manufactured
製品コード	CL0677-1200-0-51	Code No.
製品名	BM25-4S/2-V(51)	Part No.
数量	20,000	Quantity
納入者	ヒロセ電機(株)	Supplier

- 7 . Per reel 20,000 connectors.
- 8 . The dimensions in parentheses are for reference.
- 9 . Refer to JIS C 0806 and IEC60286-3  
(Packaging of components for automatic handling)
- 10 . Wrap a reinforcing collar made by polystyrene to the surface of emboss reel at the termination side in order to protect emboss carrier tape, top cover tape.

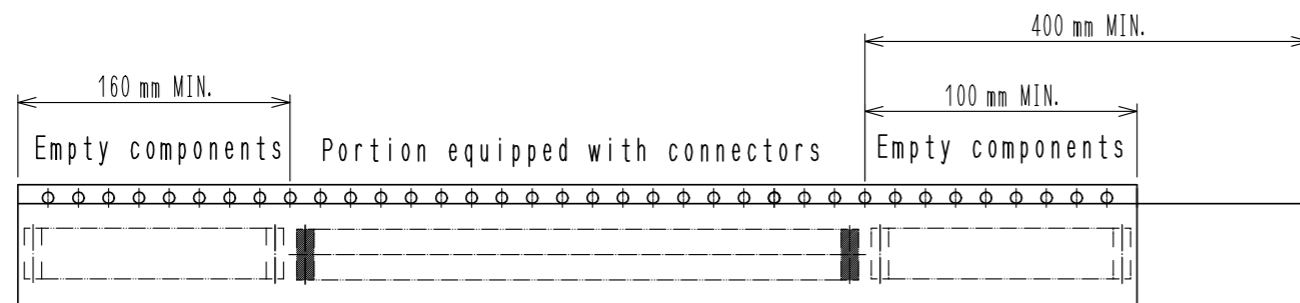

9 Taping (Free)

<b>HRS</b>	DRAWING NO.	EDC-358233-51-05
	PART NO.	BM25-4S/2-V(51)
	CODE NO.	CL677-1200-0-51
		3/4

### How to draw the FPC

BM25 series connector is intended to carry 10A electrical current for battery application. FPC may have less flexibility than usual, since the copper foil becomes wider and thicker to carry current of 10A.

Please design the FPC to have a flexibility to absorb the displacement\* of the connector caused by fixing PCB and battery.

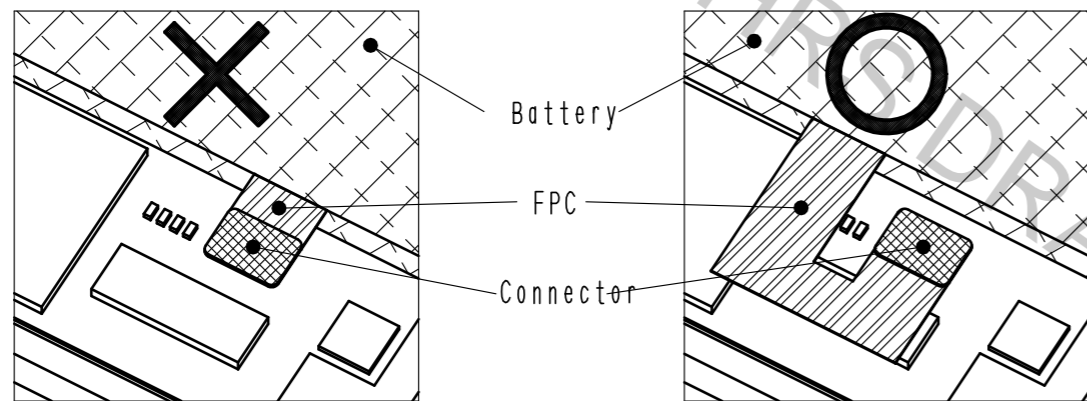

\*Possible problems caused by connector mating in incorrect positioning. Mating the connector in incorrect positioning could lose the function of the connector.

① Insulator could be broken.

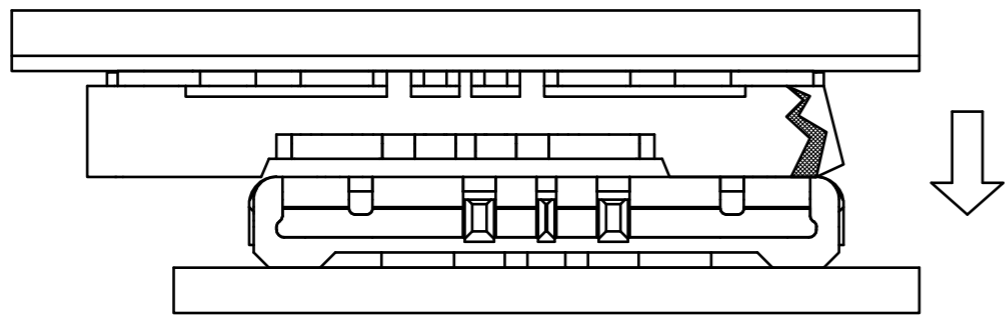

② It could apply excessive mechanical stress to single side of the contact.

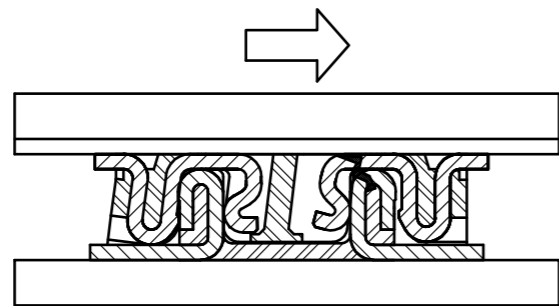

### How to draw the electrical circuit

As shown in the figure below, each power supply unit including the lock metal fitting has to be mounted on the same PCB circuit.

◆ Recommended electrical circuit layout

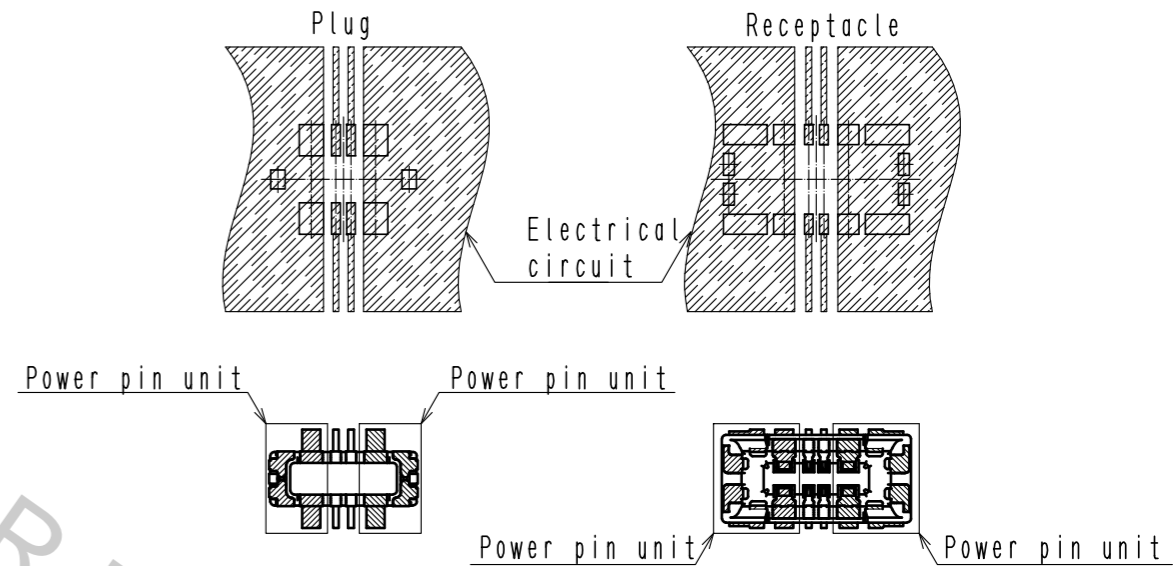

<b>HRS</b>	DRAWING NO.	EDC-358233-51-05	4/4
	PART NO.	BM25-4S/2-V(51)	
	CODE NO.	CL677-1200-0-51	