

TCK-067

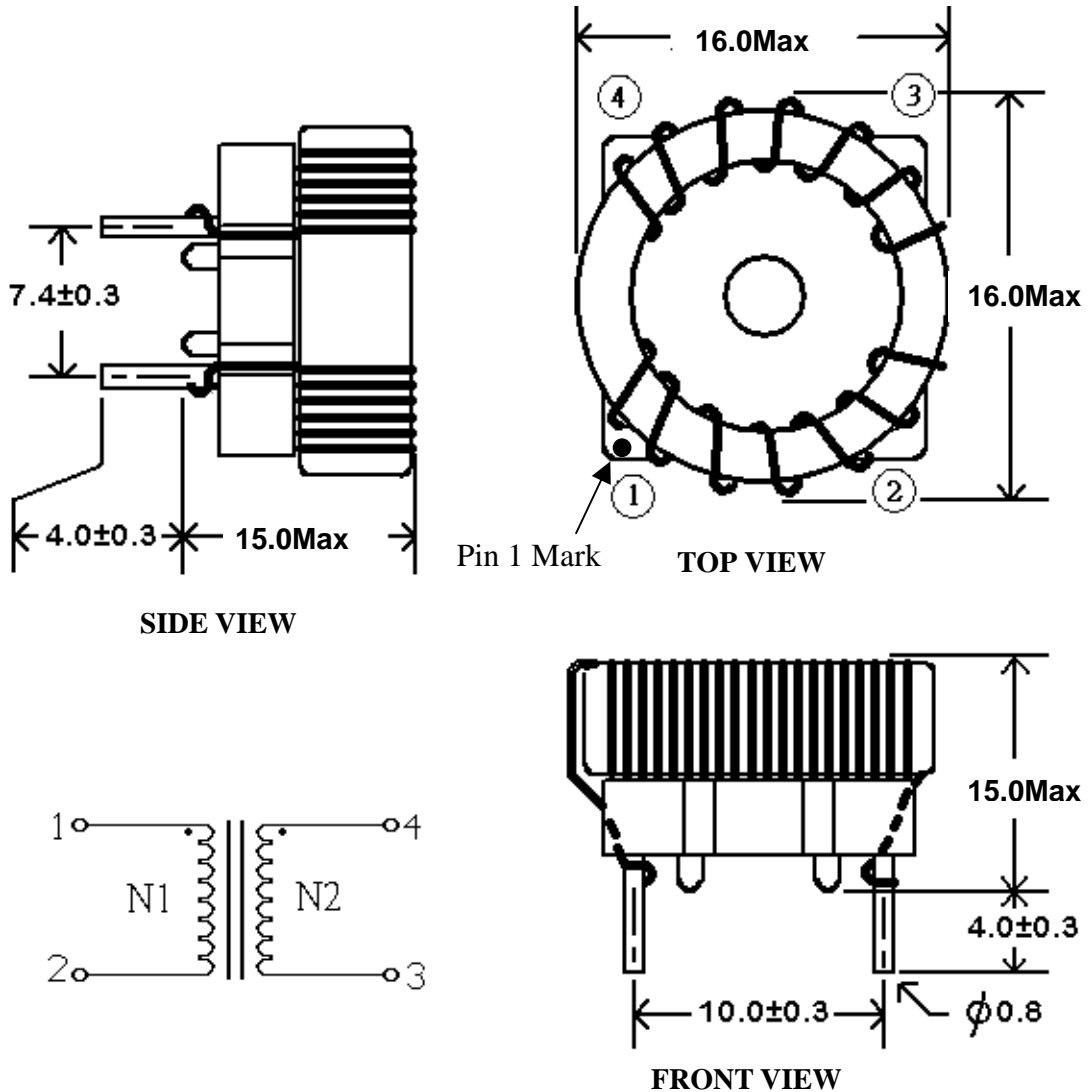

All dimensions in mm

SPECIFICATIONS

Inductance	Pin 1-2: $620\mu\text{H} \pm 35\%$ Pin 3-4: $620\mu\text{H} \pm 35\%$
	Test Condition: 100KHz/100mV Measurement Instrument: HP 4263B LCR Meter
Impedance	DCR(Max): $25\text{m}\Omega$
	Measurement Instrument: HIOKI 3540 m Ω Hitester
Rated Current	IDC(Max): 7.5A
	Measurement Instrument: Agilent 34401A Meter
Rated voltage	500VDC
Operating temperature	$-40^\circ\text{C} \sim +105^\circ\text{C}$
Recommended Through Hole	$\phi 1.0$ mm