

ESY, Aluminum Electrolytic, 105C LowZ, 330 uF, 20%, 35 VDC, -40/+105C, Lead Spacing = 5mm

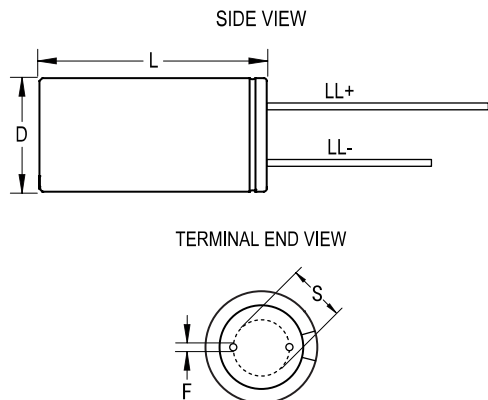

General Information	
Supplier:	KEMET
Series:	ESY
Dielectric:	Aluminum Electrolytic
Description:	LowZ Single Ended Aluminum Electrolytic
Features:	Low Z
RoHS:	Yes
Lead:	Wire Leads

Dimensions	
D	10mm +/-0.5mm
L	15mm +2mm
S	5mm +/-0.5mm
LL Negative	15mm MIN
LL Positive	20mm MIN
F	0.6mm NOM

Specifications	
Capacitance:	330 uF
Capacitance Tolerance:	20%
Voltage DC:	35 VDC, 44 VDC (Surge)
Temperature Range:	-40/+105C
Rated Temperature:	105C
Life:	4000 Hrs
Dissipation Factor:	12.00%
Resistance:	0.038 Ohms (100kHz)
Ripple Current:	1430 mAmps (100kHz 105C)
Leakage Current:	115 uA (2min 20C)
Impedance Ratio at -25C:	2
Impedance Ratio at -40C:	3

Packaging Specifications	
Packaging:	Bulk, Bag
Packaging Quantity:	3000