



MX123 Connection System

User Manual

Revision B – October 22, 2009

Table of Contents

- **Section 1:** **Product Introduction**
- **Section 2:** **Product Summary**
- **Section 3:** **Harness Assembly Instructions**
- **Section 4:** **Connector Mating Instructions**
- **Section 5:** **Service Instructions**
- **Section 6:** **Electrical Continuity Checking**
- **Section 7:** **Tool Ordering Information**
- **Section 8:** **Revision History**
- **Section 9:** **Files**
- **Section 10:** **Appendix A - Document Change History**
- **Section 11:** **Appendix B - Cleaning Instructions**



Section 1: Product Introduction

The Molex MX123 Connection System is a sealed system consisting of a header/controller, mating connectors, and terminals with the following configuration options:

- A. 80-Ckt ~ (80) 0.64mm terminals
- B. 73-Ckt ~ (72) 0.64mm and (1) 2.8mm terminals
- C. 56-Ckt ~ (56) 0.64mm terminals
- D. 49-Ckt ~ (48) 0.64mm and (1) 2.8mm terminals

HIGHLIGHTS:

- ✓ This system has multiple keying options.
- ✓ Ground blade engages before signal pins contact.
- ✓ Connector is friendly to “blind-mate” conditions.
- ✓ Connector provides temporary retention to the header before the cam assist lever arm is activated.
- ✓ Cam assist lever arm remains in pre-lock position until the harness connector is in pre-lock position on the header/controller.
- ✓ CPA remains in pre-lock position until cam assist lever arm is locked closed.
- ✓ Available with molded-in grommet seal plugs for harness customization.



Section 2: Product Summary: 73/80-Ckt

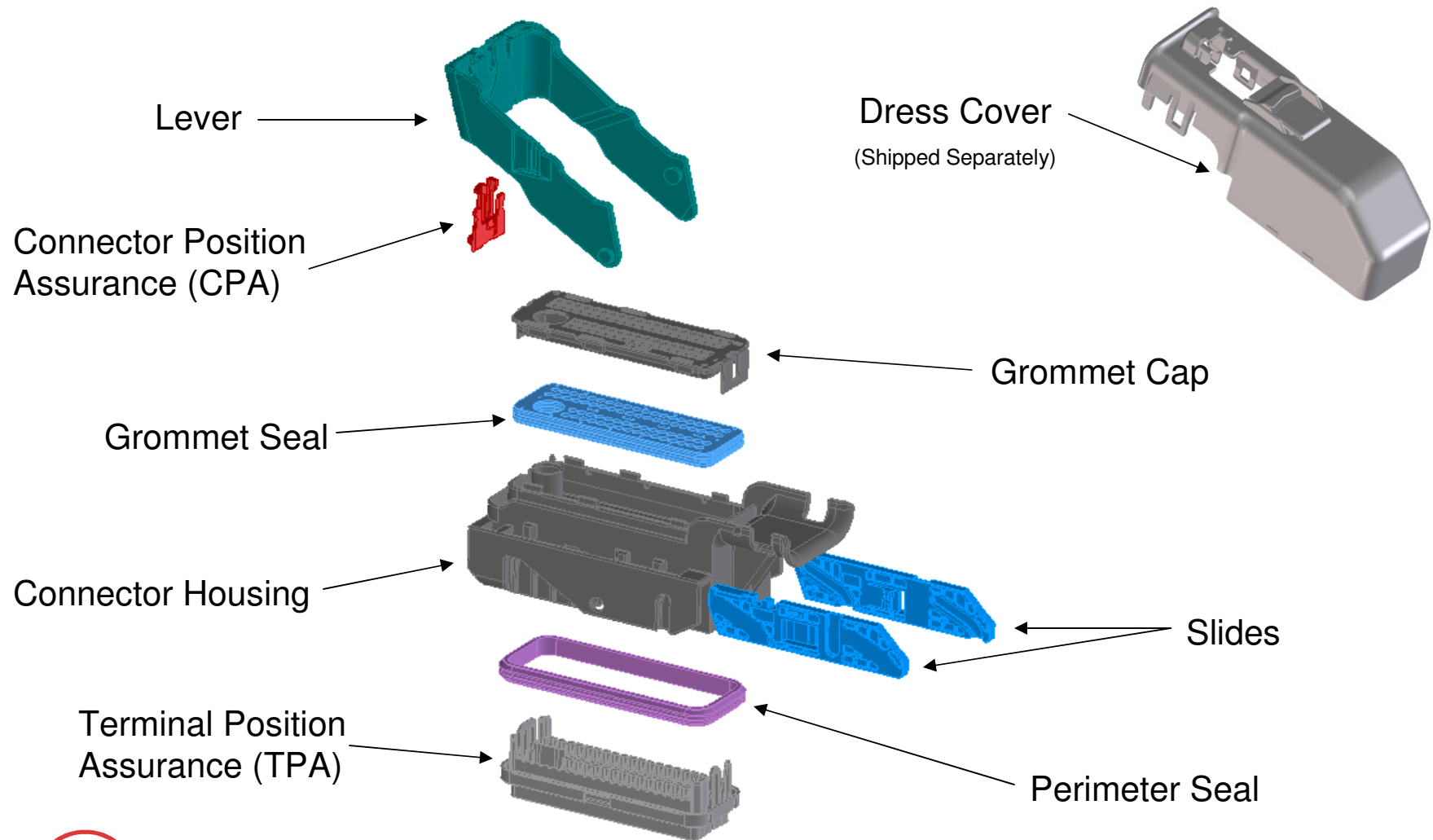

Section 2: Product Summary: 49/56-Ckt

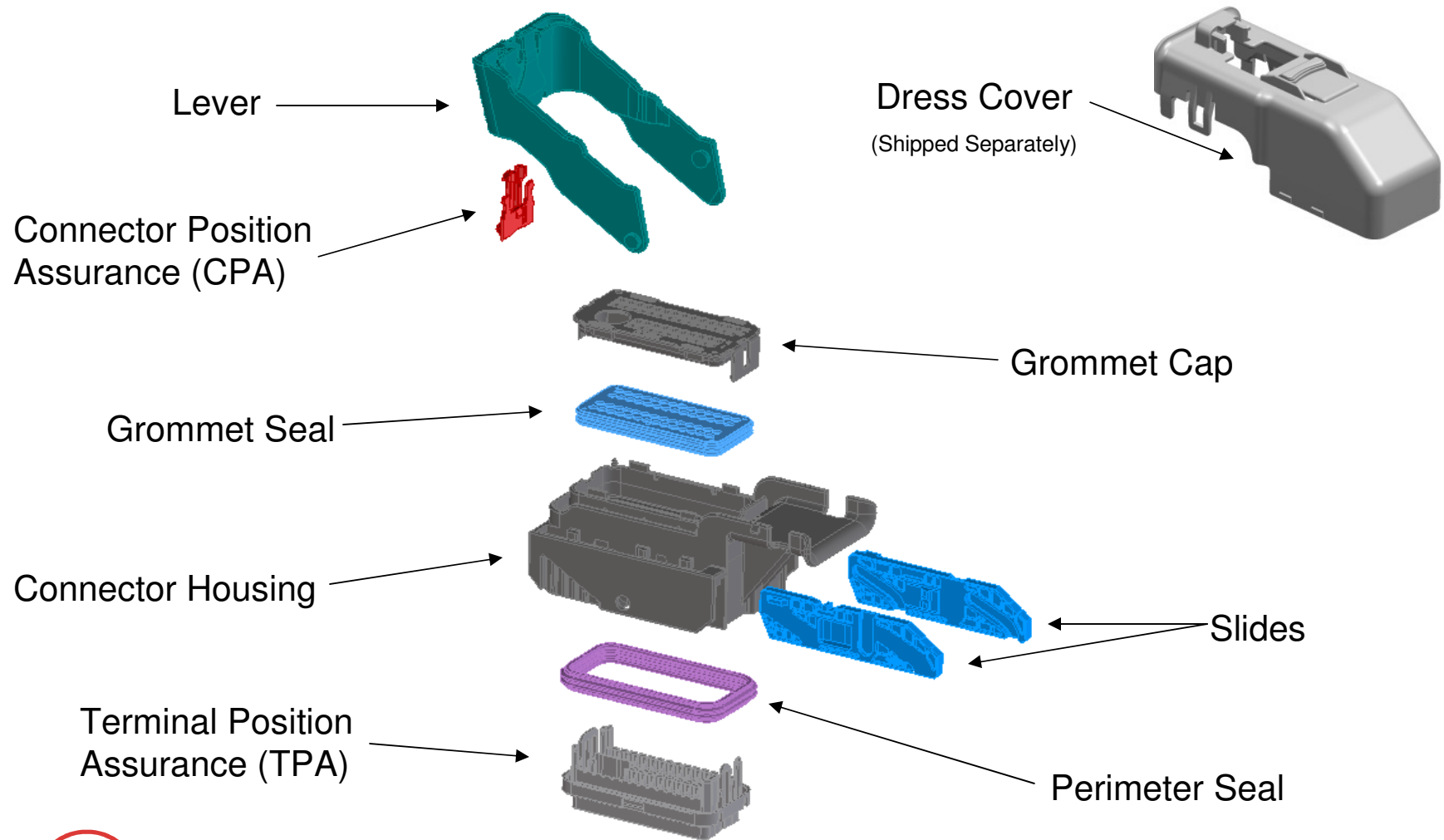

Section 2: Product Summary

MX64 Receptacle Terminal

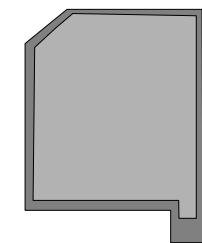
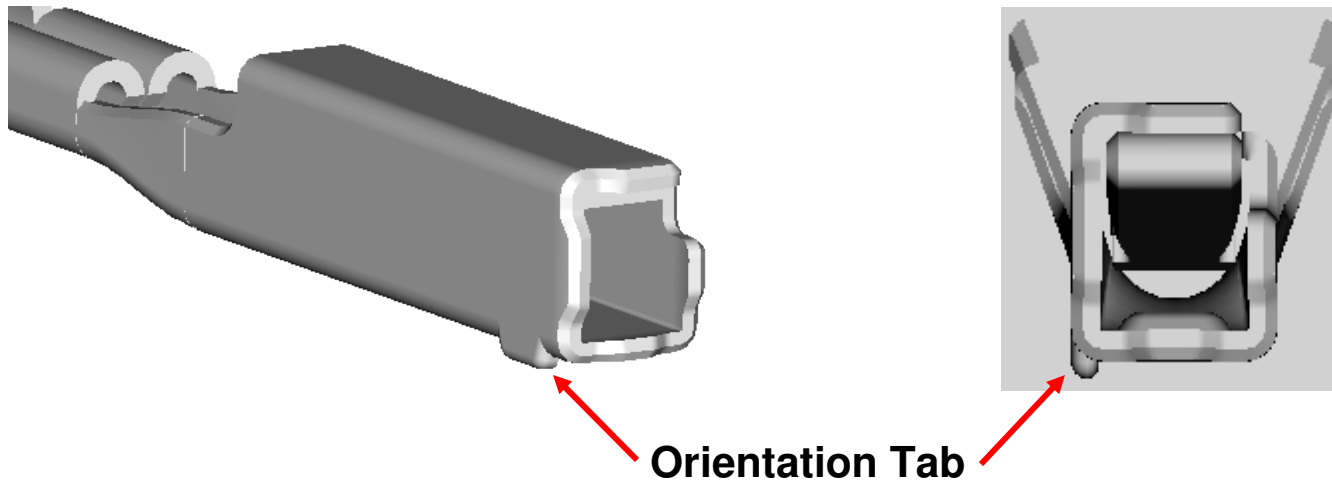

Correct Orientation

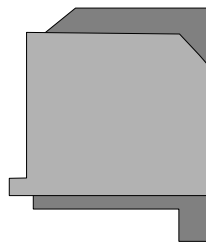

90° Misorientation
Lock-out

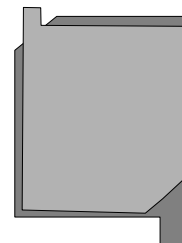

180° Misorientation
Lock-out

Orientation of receptacle terminal during insertion to grommet cap



Section 2: Product Summary

MX64 Receptacle Terminal

**Terminal Grip Code "A":
22 GA. Wire**

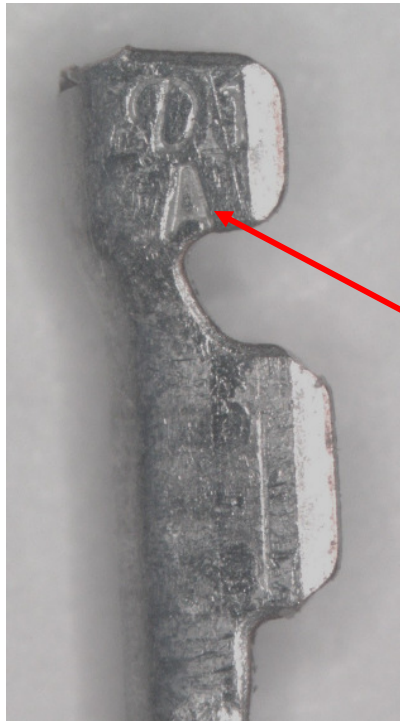

**Terminal Grip Code "B":
18/20 GA. Wire**

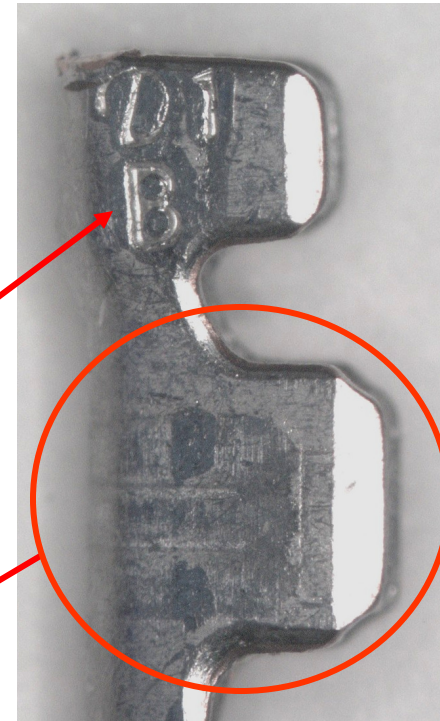

Grip Codes

Visibly Bigger!



Section 2: Product Summary

2.80mm Receptacle Terminal

(Yazaki Terminal and Cable Seal)

7116-4152-02 Yazaki 2.8mm RCPT TERM Tin 14 Cable Seal

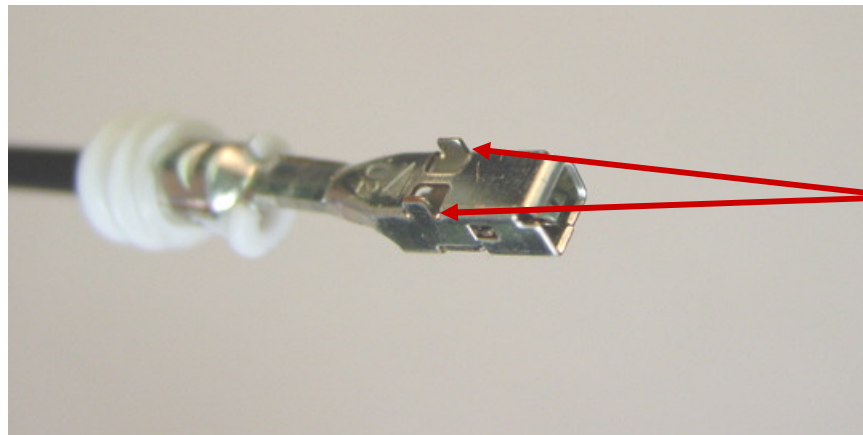

Orientation Tabs

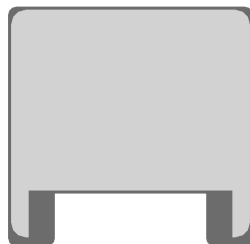

Correct Orientation

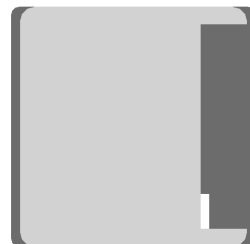

90° Misorientation
Lock-out



180° Misorientation
Lock-out

Orientation of receptacle terminal during insertion to grommet cap



Section 2: Product Summary

Grommet Seal Plug – Features

Molex Part 34586-0001

Rectangular head for ease of removal from grommet seal cover.

Rectangular cross-section to prevent mis-orientation into the grommet seal cover.

Sealing surface

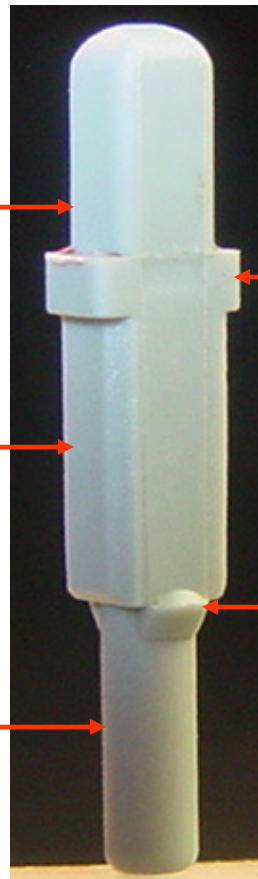

Shoulder area provides forward stop.

Lock tabs to provide seal plug retention to grommet seal cover.



Section 2: Product Summary

73/80-Ckt “As Shipped”

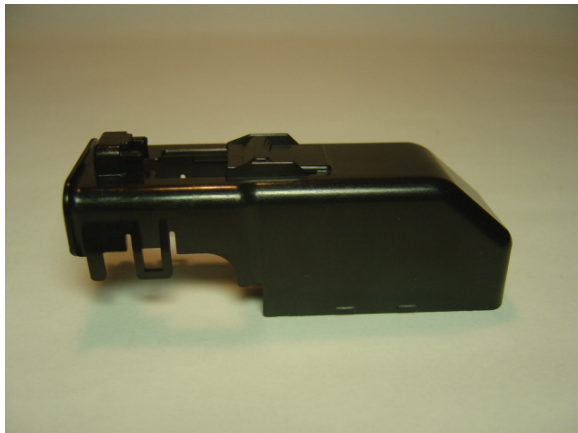
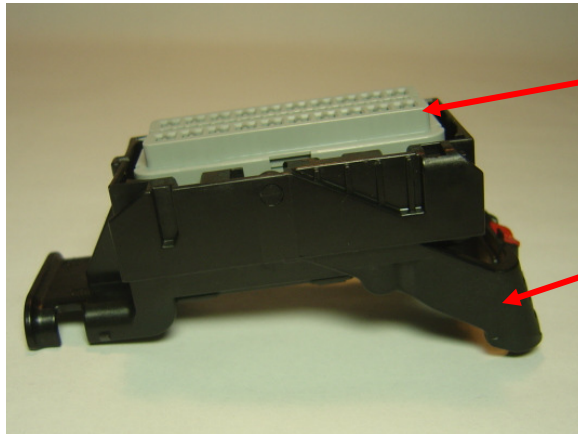

49/56-Ckt “As Shipped”

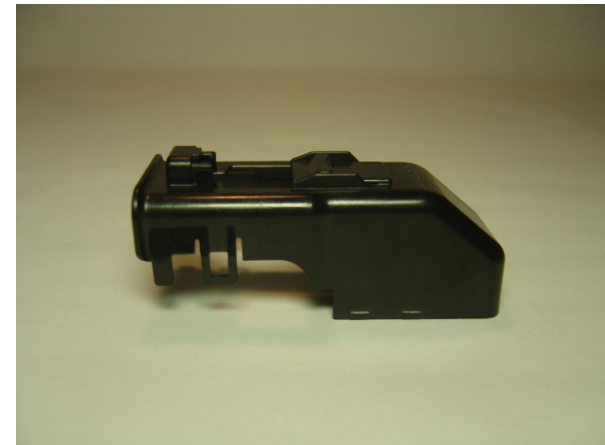
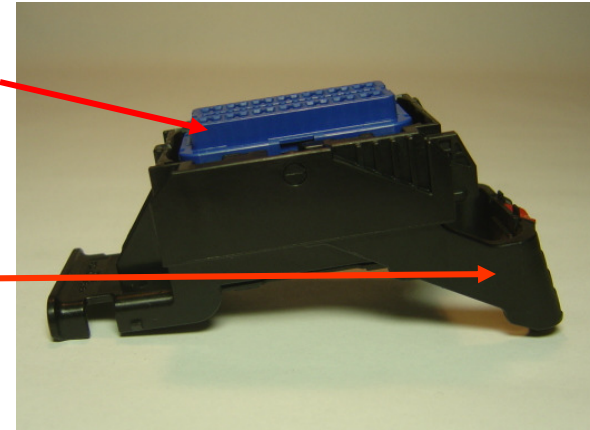

Harness connector assembly shipped with TPA & lever in pre-lock position.

Lever will remain in pre-lock until mated with header/controller, or a force over 190N is achieved.

If lever moves freely from pre-lock position without being mated to Header/Controller:
Do Not Use Connector!

Dress Cover Shipped Separately.



Section 3: Harness Assembly Instructions

A. TPA shown in “As Shipped” position

- TPA to remain in pre-lock position (as shipped) until all terminals are loaded (Figs. 3-1 and 3-2). **TPA is not to be removed from connector!**

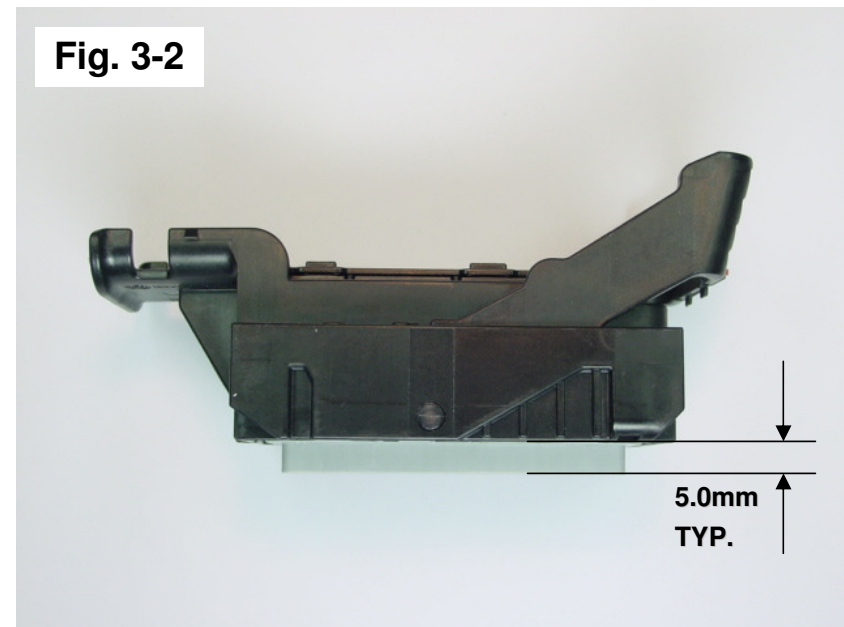
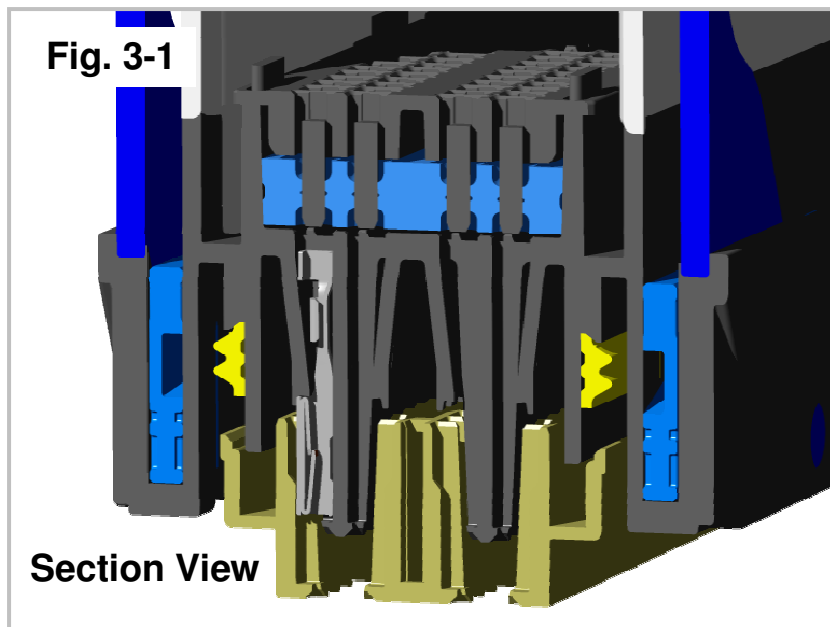

Views of TPA in “Pre-Lock” Position



Section 3: Harness Assembly Instructions

B. Connector Circuit Locations

WIRE BUNDLE SIDE

20	40	60	80
19	39	59	79
18	38	58	78
17	37	57	77
16	36	56	76
15	35	55	75
14	34	54	74
13	33	53	73
12	32	52	72
11	31	51	71
10	30	50	70
9	29	49	69
8	28	48	68
7	27	47	67
6	26	46	66
5	25	45	65
4	24	44	64
3	23	43	63
2	22	42	62
1	21	41	61

Wire tie area

80-Ckt

WIRE BUNDLE SIDE

73		52	72
		51	71
		50	70
		49	69
16	32	48	68
15	31	47	67
14	30	46	66
13	29	45	65
12	28	44	64
11	27	43	63
10	26	42	62
9	25	41	61
8	24	40	60
7	23	39	59
6	22	38	58
5	21	37	57
4	20	36	56
3	19	35	55
2	18	34	54
1	17	33	53

Wire tie area

73-Ckt

WIRE BUNDLE SIDE

14	28	42	56
13	27	41	55
12	26	40	54
11	25	39	53
10	24	38	52
9	23	37	5
8	22	36	50
7	21	35	49
6	20	34	48
5	19	33	47
4	18	32	46
3	17	31	45
2	16	30	44
1	15	29	43

Wire tie area

56-Ckt

**WIRE BUNDLE
SIDE SHOWN**



Section 3: Harness Assembly Instructions

C. Terminal Installation

- For ease of assembly, it is recommended that when populating the connector, wires be populated in the following manner (see Fig 3-3): 1) Fully populate down Column 1 and then 2) continue on to Column 2 and so forth until the entire connector is populated. Refer to Fig 3-4 for proper terminal orientation.

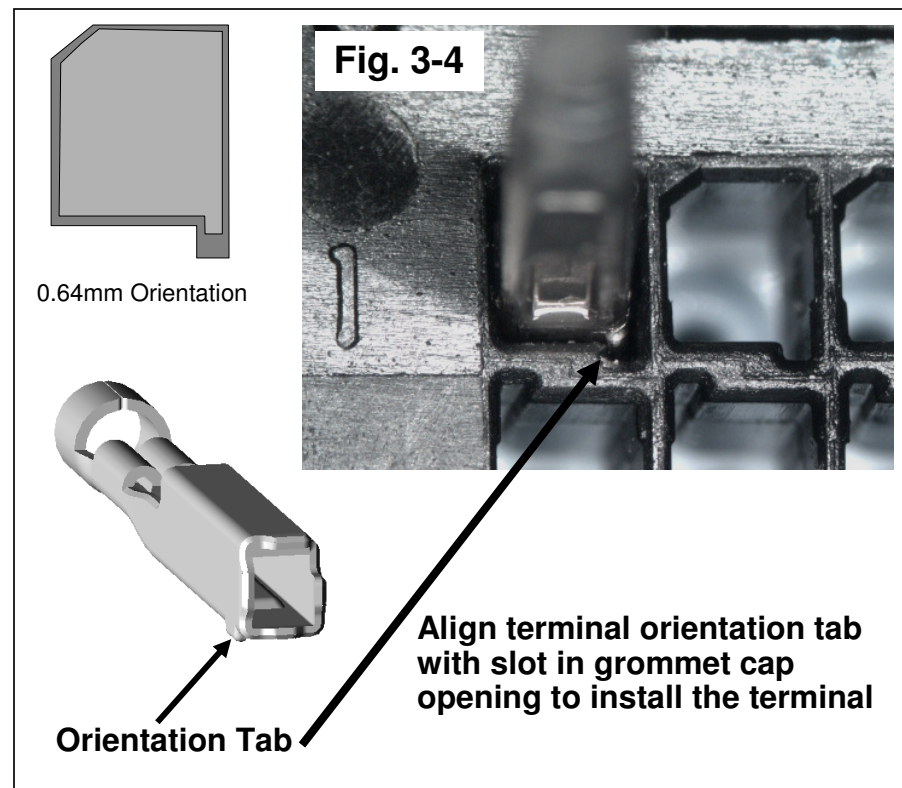
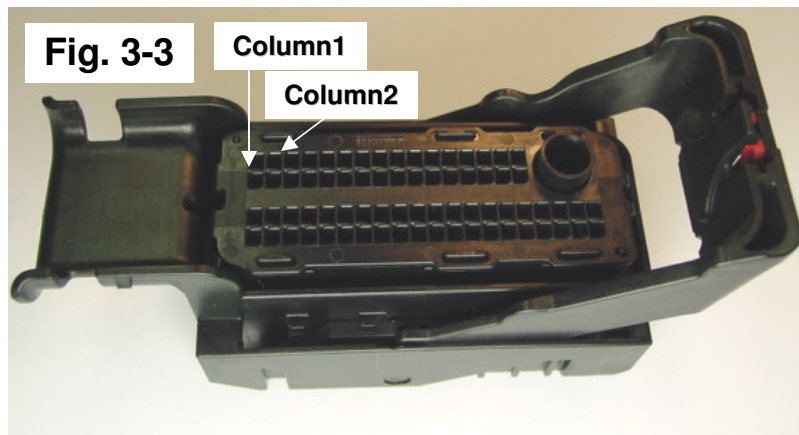

Section 3: Harness Assembly Instructions

C. Terminal Installation (continued)

- With TPA still in pre-lock position, orient terminal to rear of connector.
- Grip the wire (Fig. 3-5) and insert terminal through appropriate circuit opening (Fig. 3-6). If resistance is encountered, retract the terminal and adjust the angle of insertion. Continue inserting the terminal until it stops and locks up on the lock finger with an audible click. Tug slightly on wire to ensure terminal is locked.

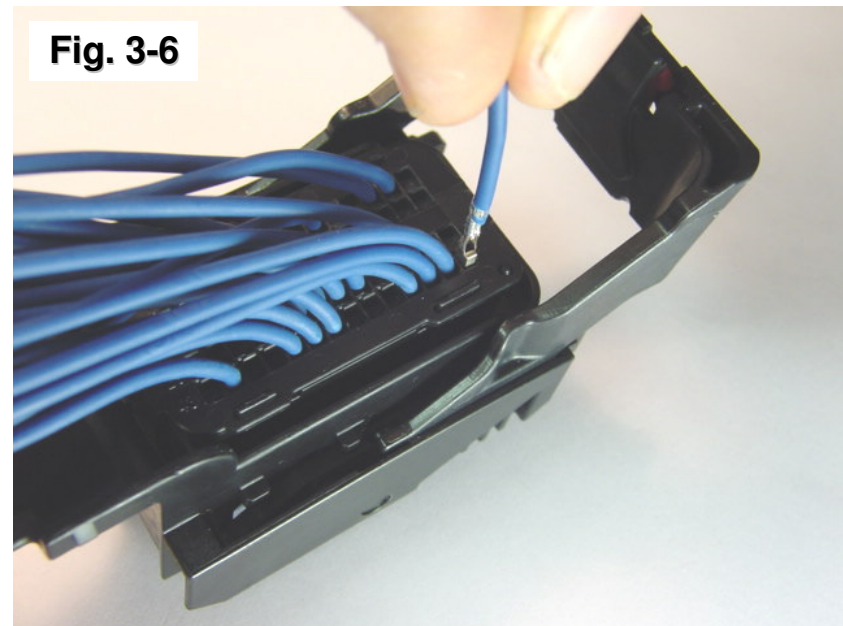
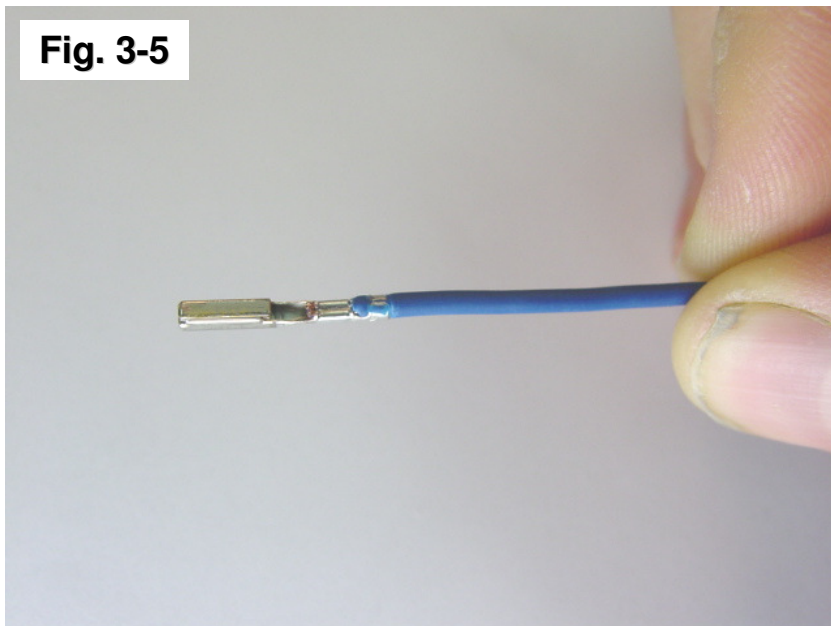

Section 3: Harness Assembly Instructions

D. Wire Dressing Method

- After inserting a terminal, bend the wire as close to the grommet cap as possible and position as shown below. Continue populating terminals as necessary.

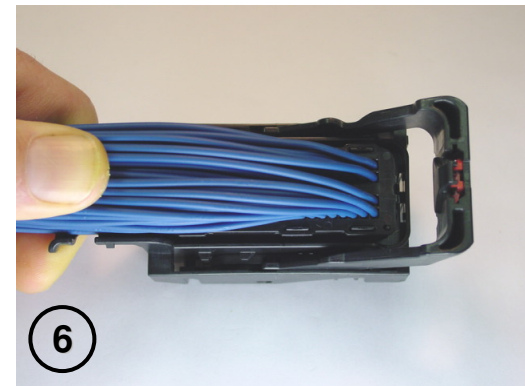
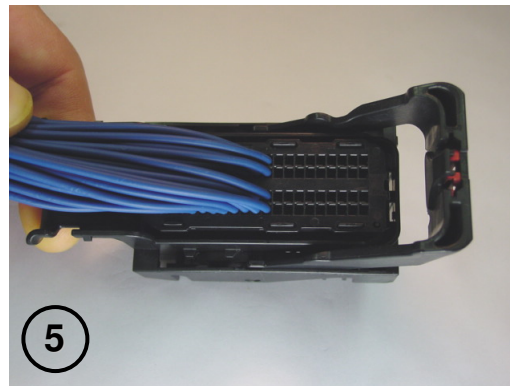
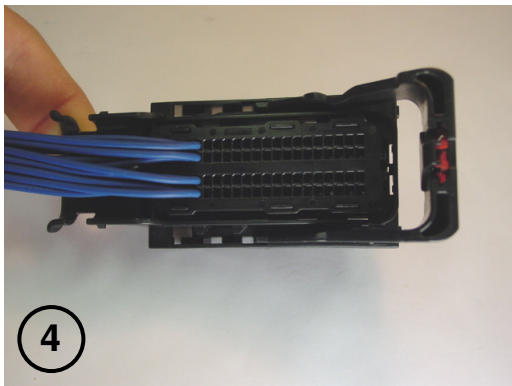
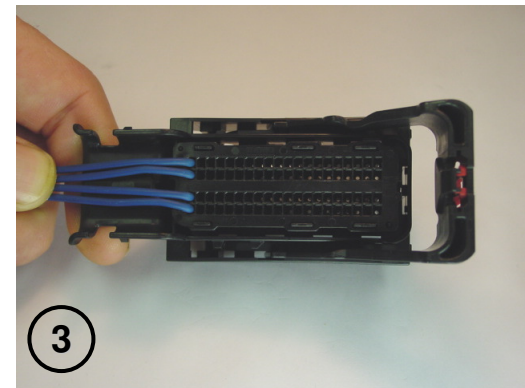
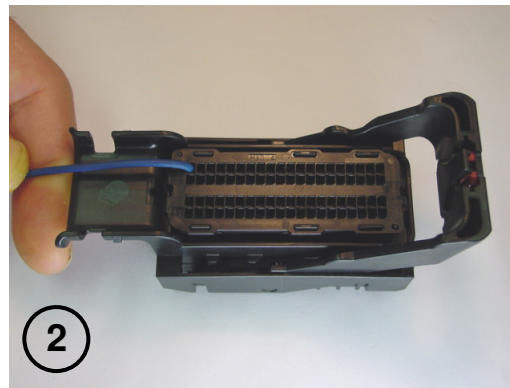
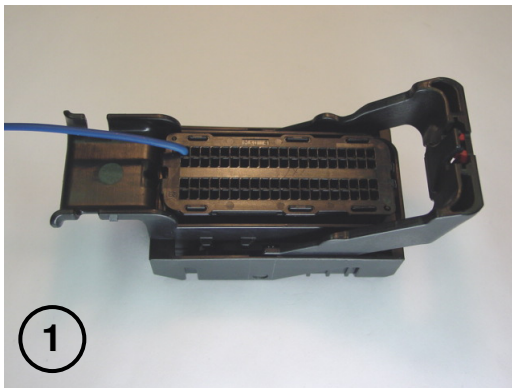

Section 3: Harness Assembly Instructions

E. Grommet Seal Cover - Knockout Patterns

* Molded-in or single grommet seal plugs are used to seal unused circuit locations.

NOTE! Molded-in grommet seal plug knockout patterns will vary based on application specific circuit locations. Single grommet seal plugs may still need to be used to seal circuits without molded-in seal plugs.

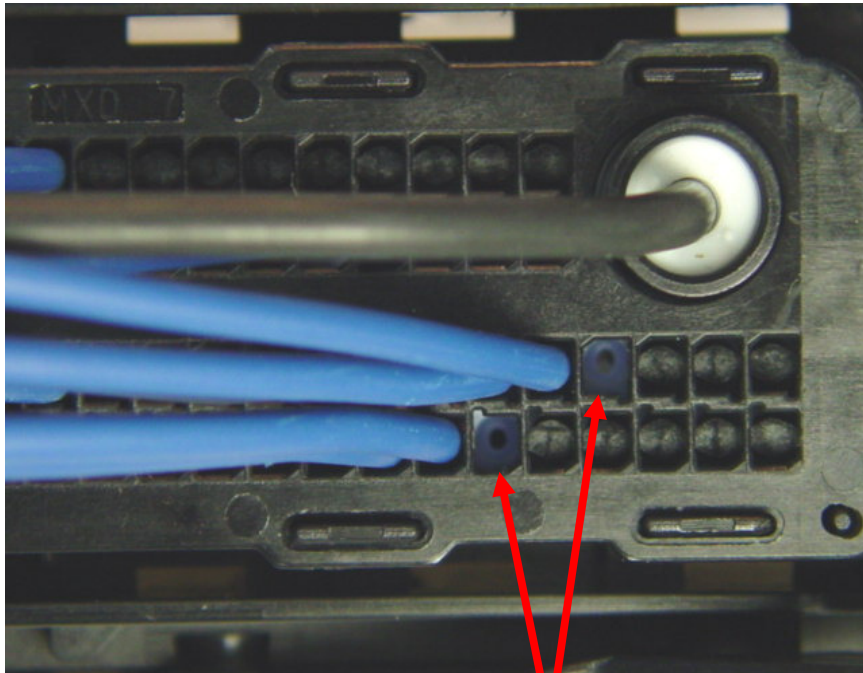

Cavities Open For Circuits



Molded-in grommet seal plugs



Section 3: Harness Assembly Instructions

F. Grommet Seal Plug Installation

- **Step 1:** Orient seal plug to the opening in the grommet cap. Plug should not be installed when rotated 90 degrees from proper orientation.
- **Step 2:** Hold head of seal plug securely to prevent rotation during assembly.
- **Step 3:** Push seal plug until it locks into position into the grommet cap.
- **Step 4:** Verify that seal plug shoulder is flush with grommet cap as shown in cavities 33 and 53.

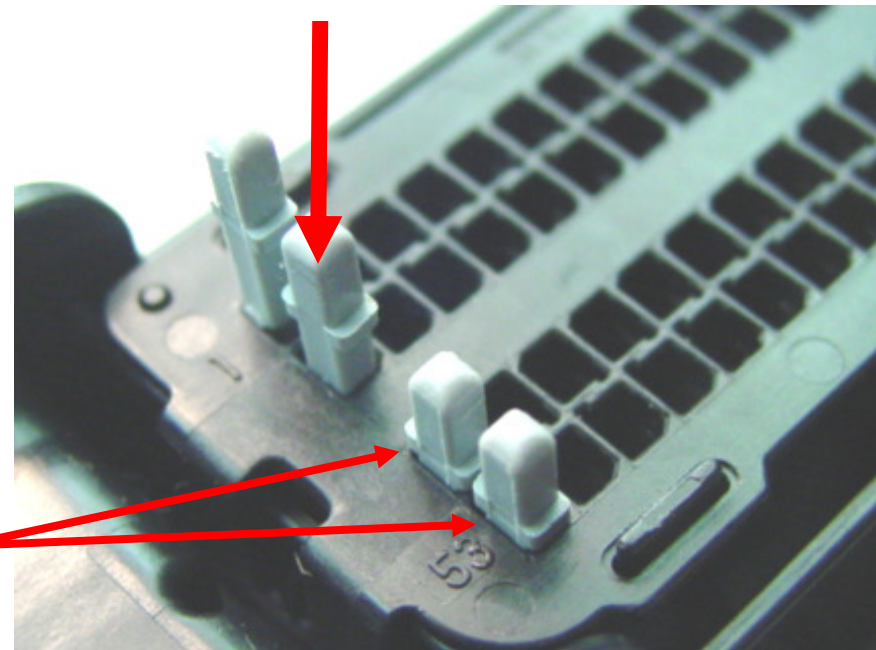

Section 3: Harness Assembly Instructions

G. TPA - Seating

- With the terminals fully installed, the TPA can be seated into its final lock position by applying an even force to both ends (Fig. 3-7) until it comes to a stop (Fig. 3-8). If the TPA resists, it may be detecting a partially installed terminal. Pull the TPA back into its pre-lock position and make sure all terminals are fully seated. Upon completion, the TPA can be seated.

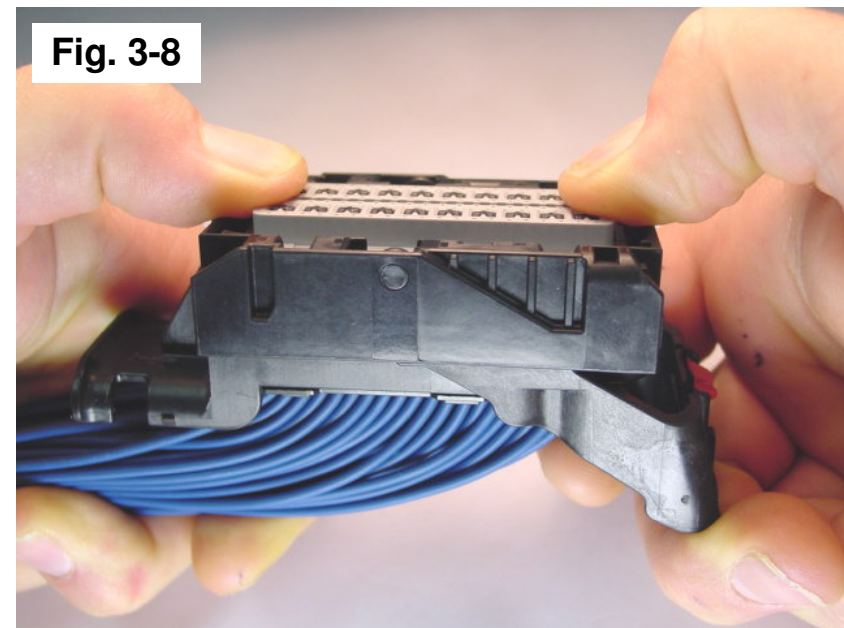
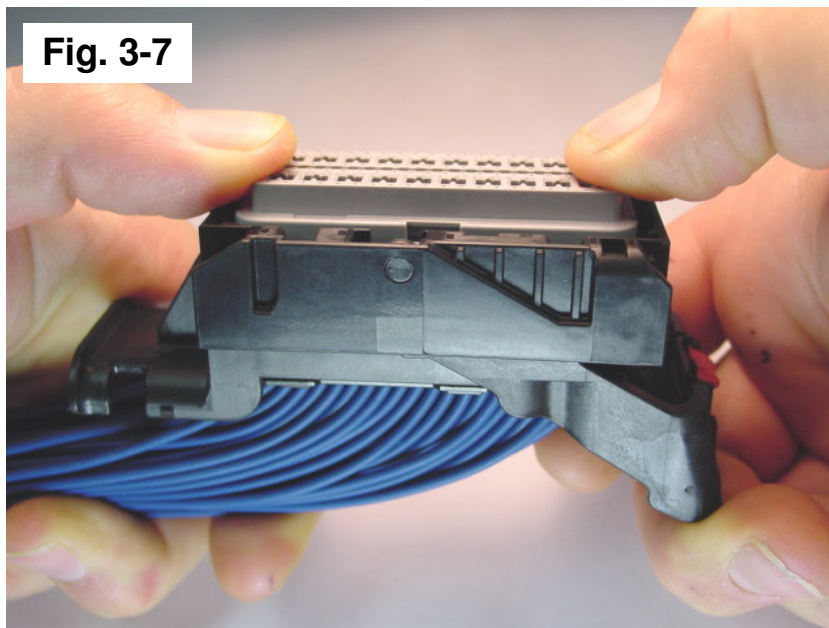

Section 3: Harness Assembly Instructions

H. Wire Bundle Dressing

- After seating the TPA, insert a tie-wrap around the connector (Fig. 3-9) and around the wire bundle as shown (Fig. 3-10).
- While clasping the wire bundle and connector firmly, tighten the tie-wrap securely around the bundle using an appropriate tie-wrap gun to meet the specifications listed in Table 1 (next page) and shown in Fig. 3-11 and Fig. 3-12 (next page).

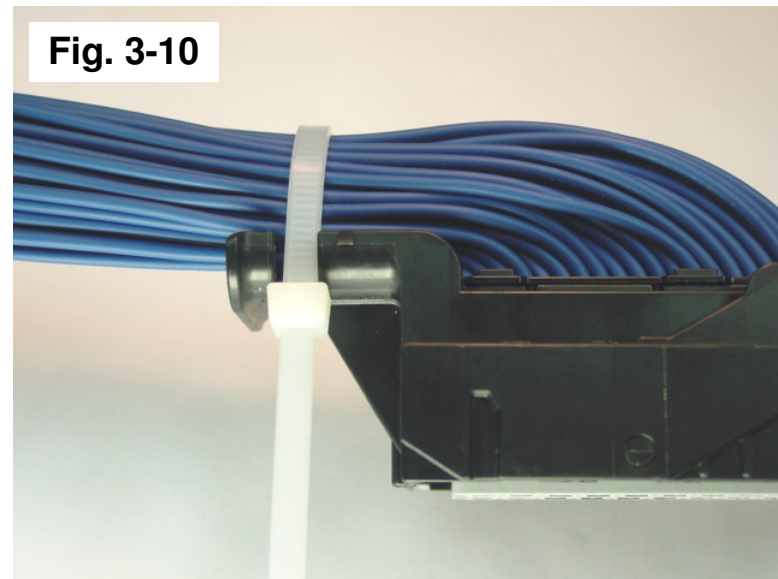
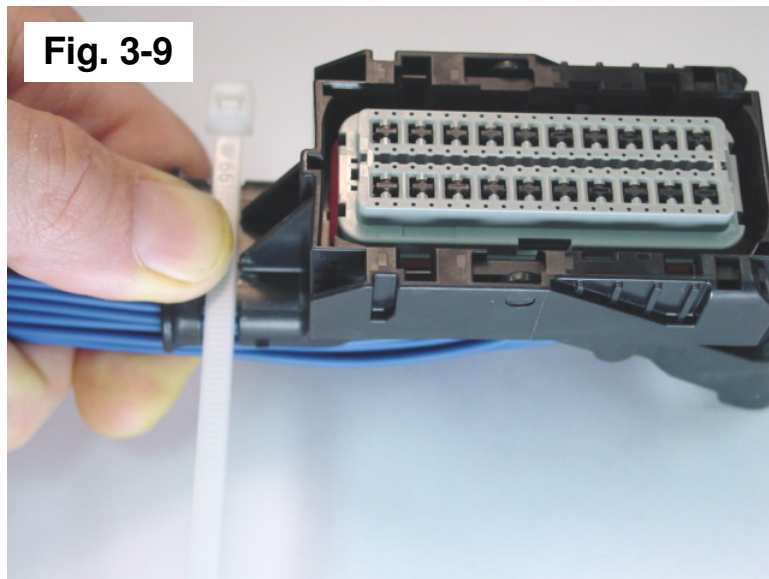

Section 3: Harness Assembly Instructions

H. Wire Bundle Dressing (continued)

Table 1: Dress Cover part numbers

GM Part No.	Molex Part No.	Description	Height (H)	Width (W)
12582676	34565-0003	73/80 Ckt	≤ 44 mm	≤ 24 mm
12582679	34575-0003	49/56 Ckt	≤ 43 mm	≤ 24 mm

Fig. 3-11

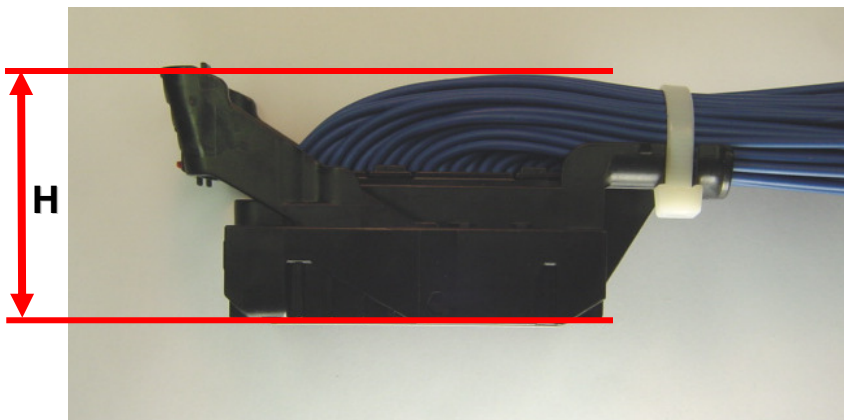
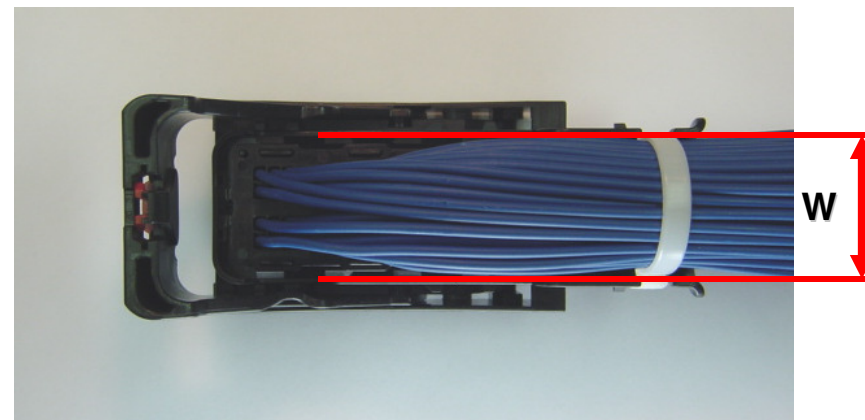

Fig. 3-12



Wire Bundle Height and Width Specifications



Section 3: Harness Assembly Instructions

I. Dress Cover Installation

- After tie-wrapping the wire bundle, install dress cover by inserting the front of the dress cover into the connector housing (Fig. 3-13) and pushing the opposite end (Fig. 3-14) until it snaps into position. **Fully seated dress cover and TPA can be verified by ensuring MAX. height dimension (Fig. 3-14).**

Fig. 3-13

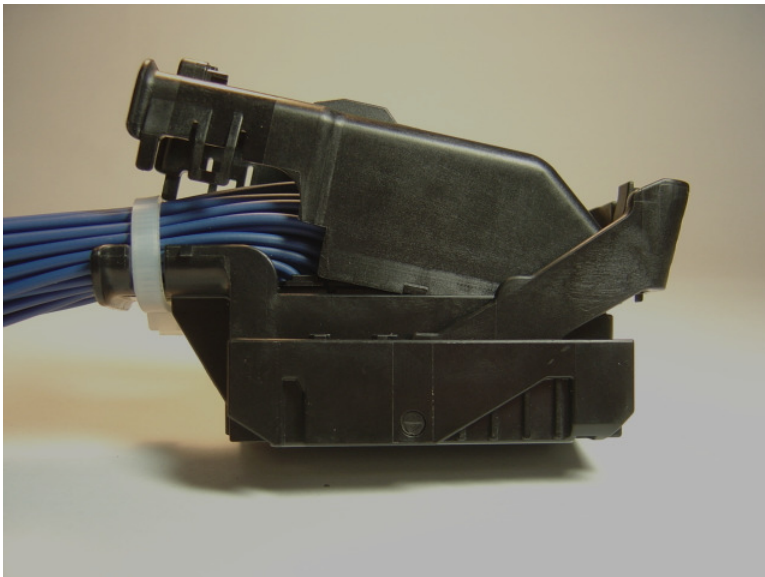

Step 1: Insert front end into housing.

Fig. 3-14

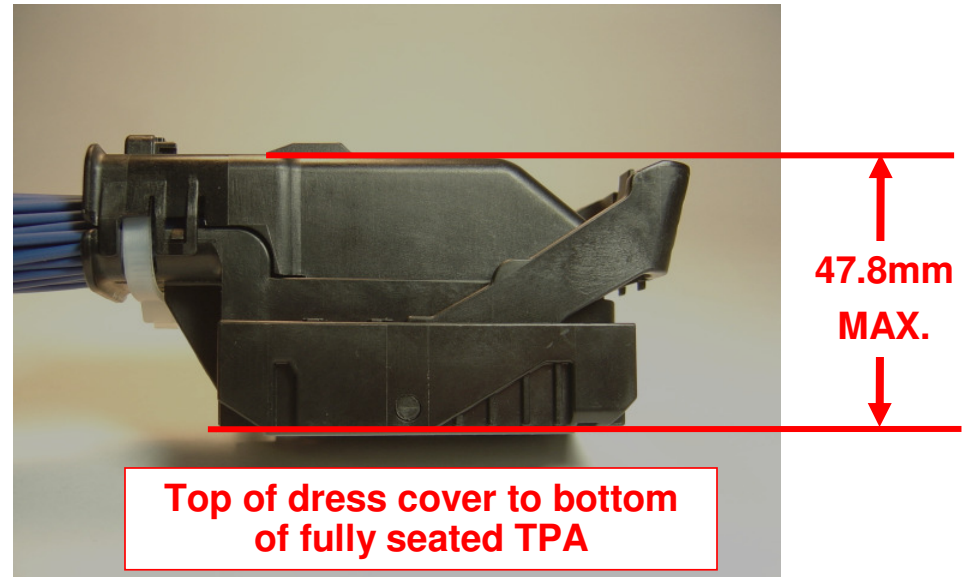

Step 2: Press down to lock position.



Section 4: Connector Mating Instructions

A. Harness Connector To Header/Controller Color Identification

- The harness connector TPA will be color-coded to match the appropriate controller header (Fig. 4-1).

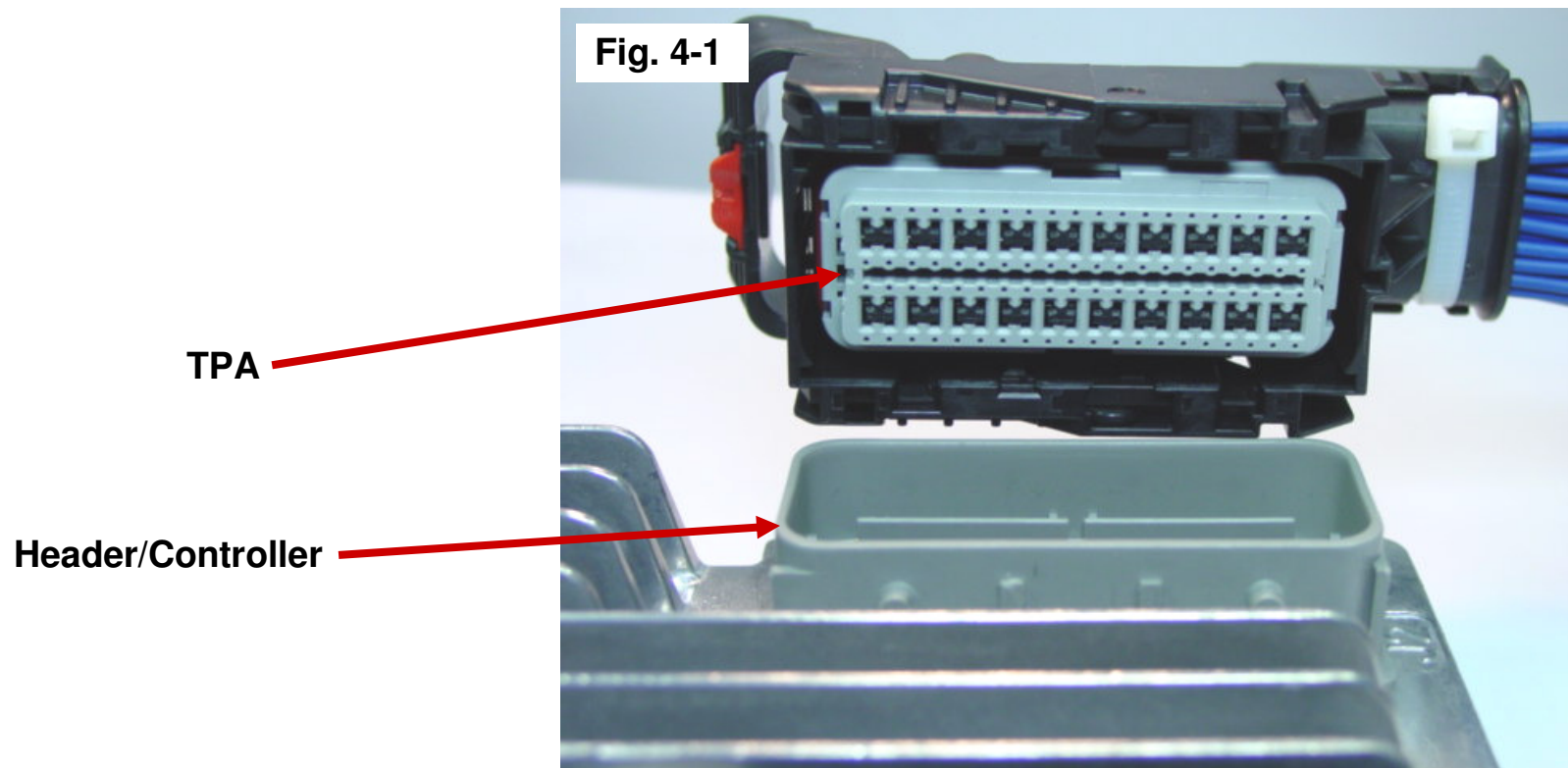

Section 4: Connector Mating Instructions

B. Harness Connector to Header/Controller Installation Into Pre-Lock

- Correctly orient the harness connector (align keying features) onto the controller connector (Fig. 4-2). Grip the top of the harness connector and evenly push the connector downward until the lever moves slightly forward (Fig. 4-3).

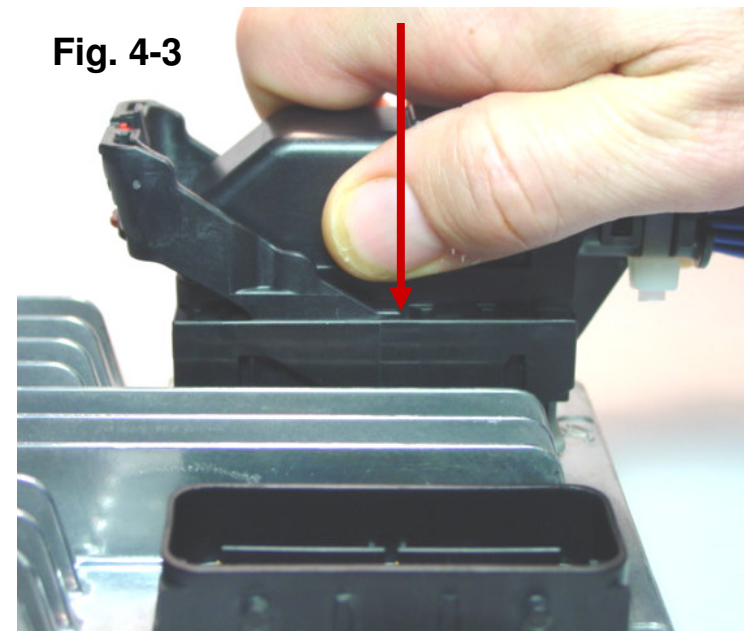
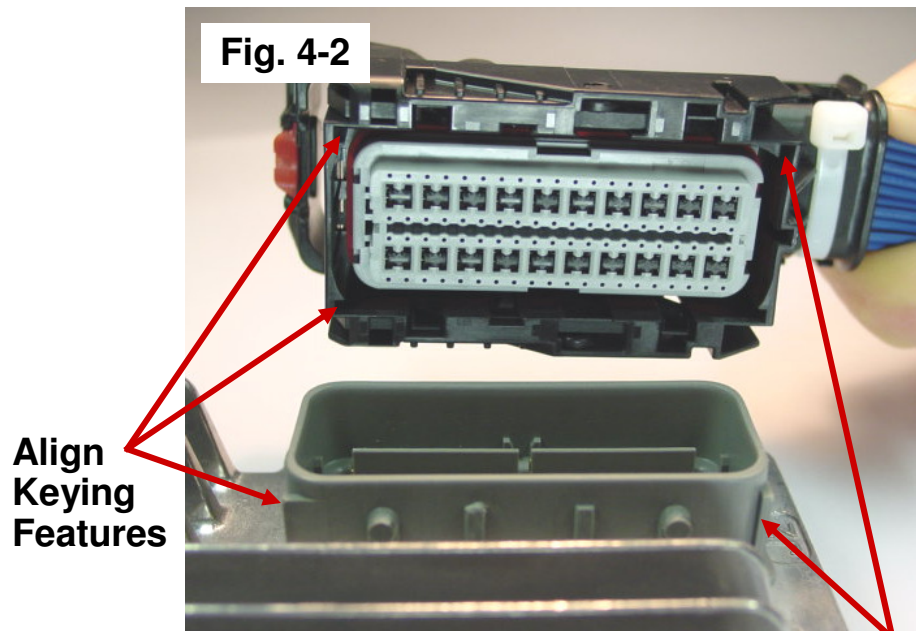

Align Keying Features



Section 4: Connector Mating Instructions

- **Caution!**
- **Installing the harness connector at an extreme angle (see fig 4- 4) may result in seal “scooping” creating an environment for fluid ingress.**
- **Damage to the header, or connector is possible if excessive force is used.**

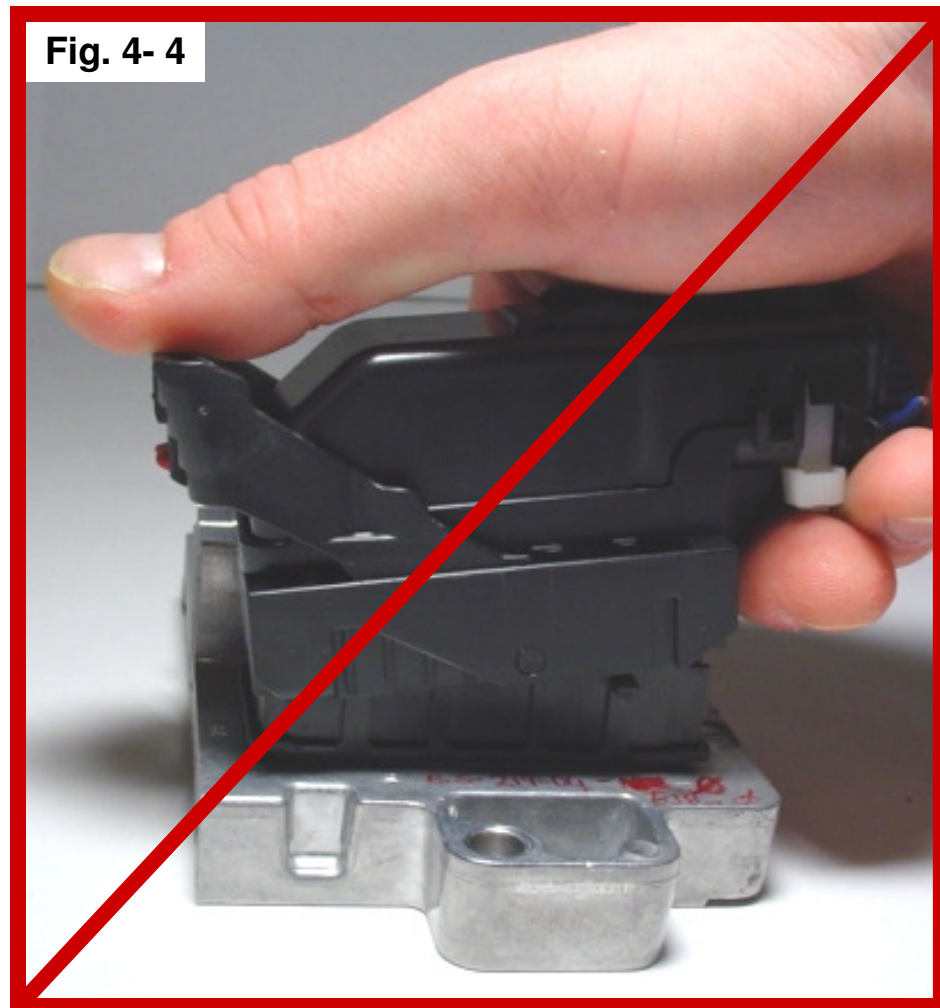

Section 4: Connector Mating Instructions

C. Harness Connector to Header/Controller Mating To Final Lock

- To begin mating the harness connector to the header/controller, place the palm of your hand on the face of the lever. Push back the connector lever towards the wire bundle to engage the harness connector to the controller header (Fig. 4- 5). Mating force should be smooth and continuous. If not, remove the connector and repeat step B.
- Continue to rotate the lever arm (Fig. 4- 6).

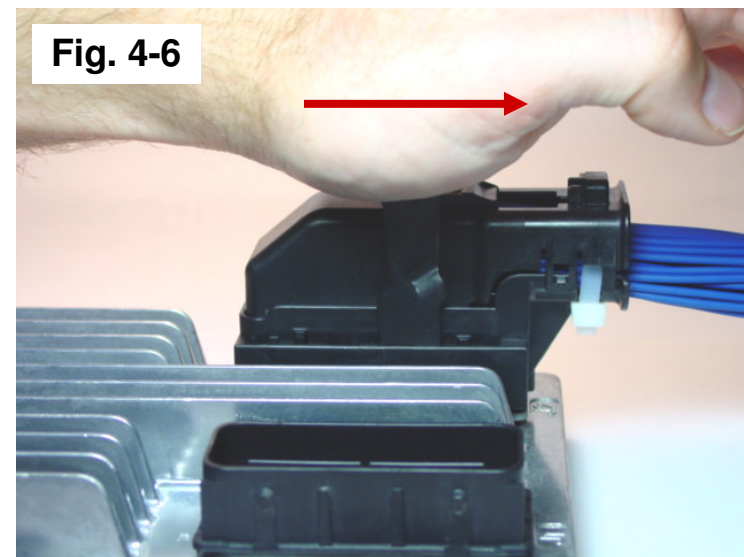
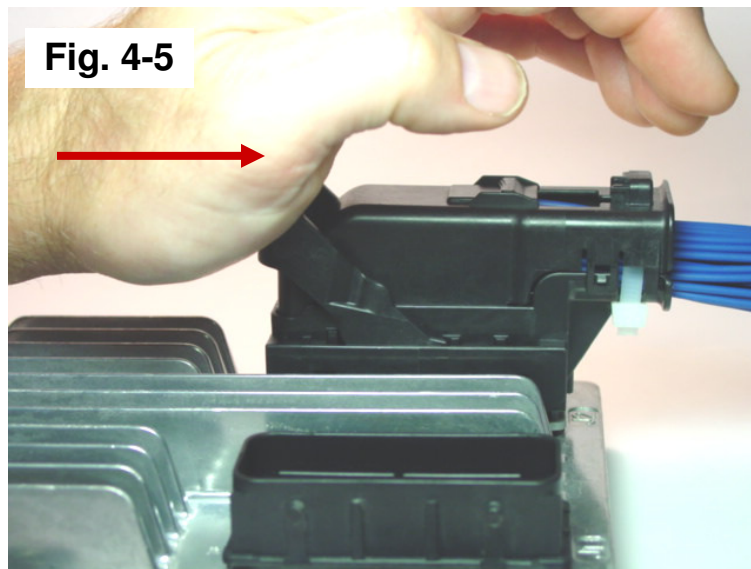

Section 4: Connector Mating Instructions

C. Harness Connector to Header/Controller Mating To Final Lock (continued)

- Continue to rotate the lever until you hear the primary latch click into final lock over dress cover primary latch (Fig. 4-7a and 4-7b).

Fig. 4-7a

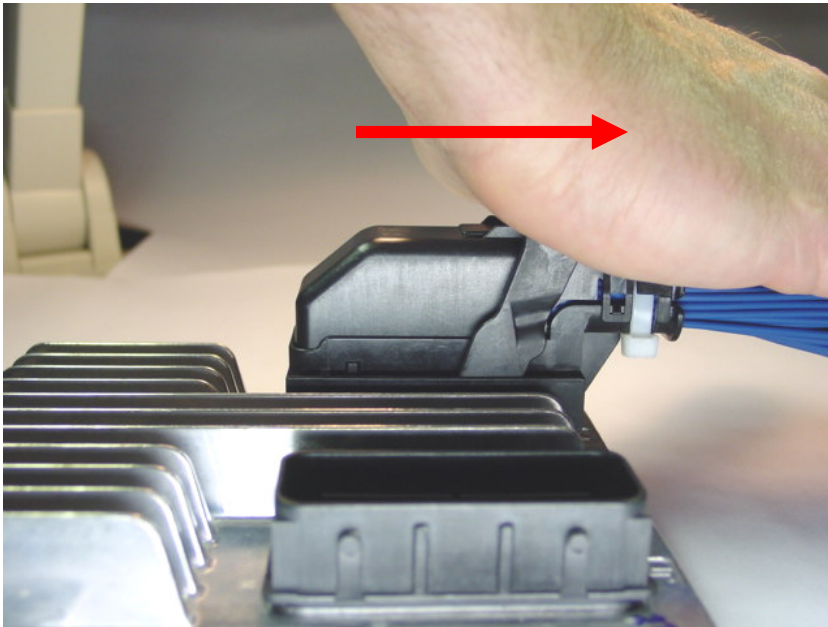
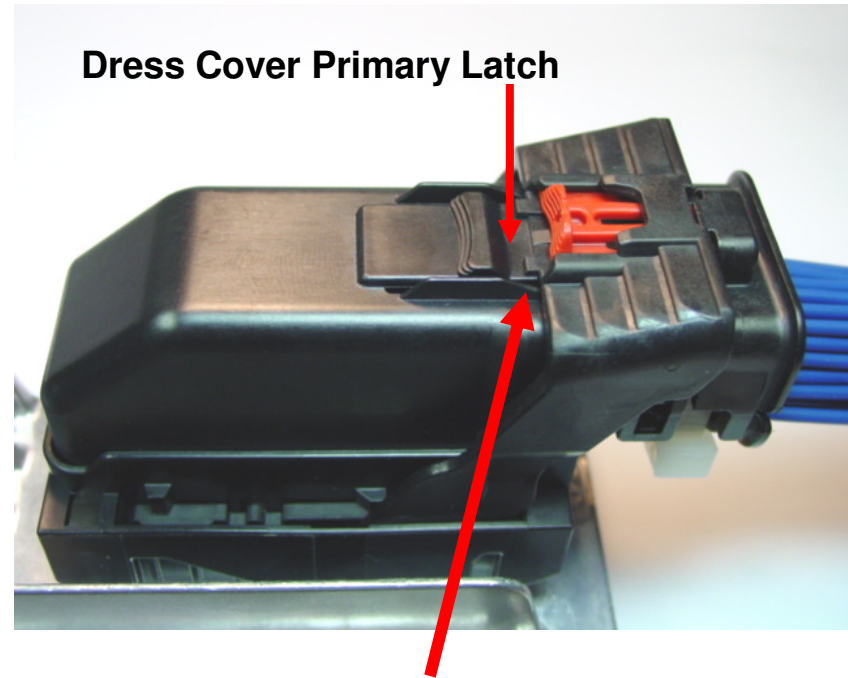

Fig. 4-7b



Primary Latch Engaged



Section 4: Connector Mating Instructions

D. Connector Position Assurance (CPA)

- With the harness connector lever arm in its latched position, the CPA can now be engaged. Push the CPA toward the wire bundle (Fig. 4- 8) until it clicks into its final locked position (Fig. 4-9).

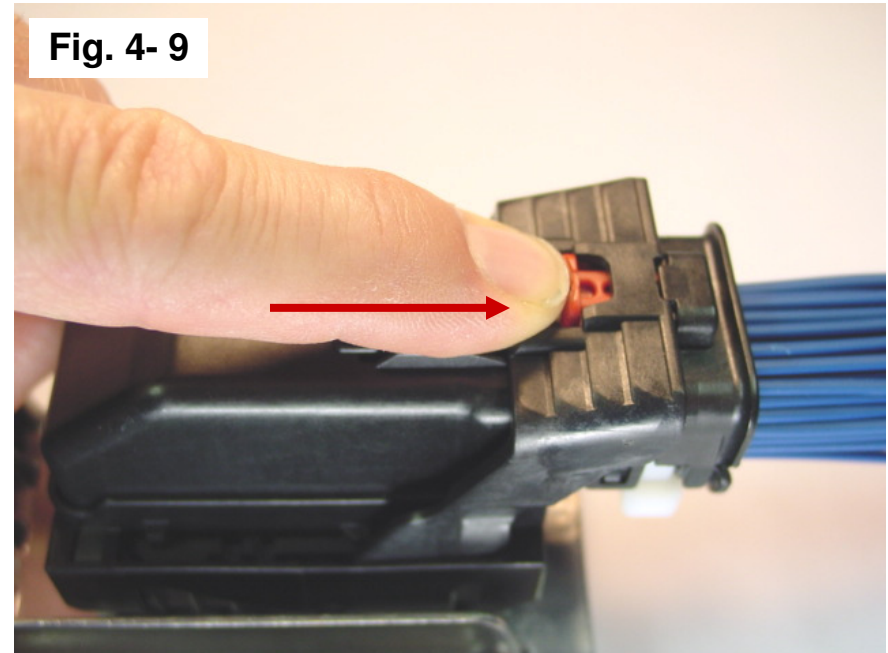
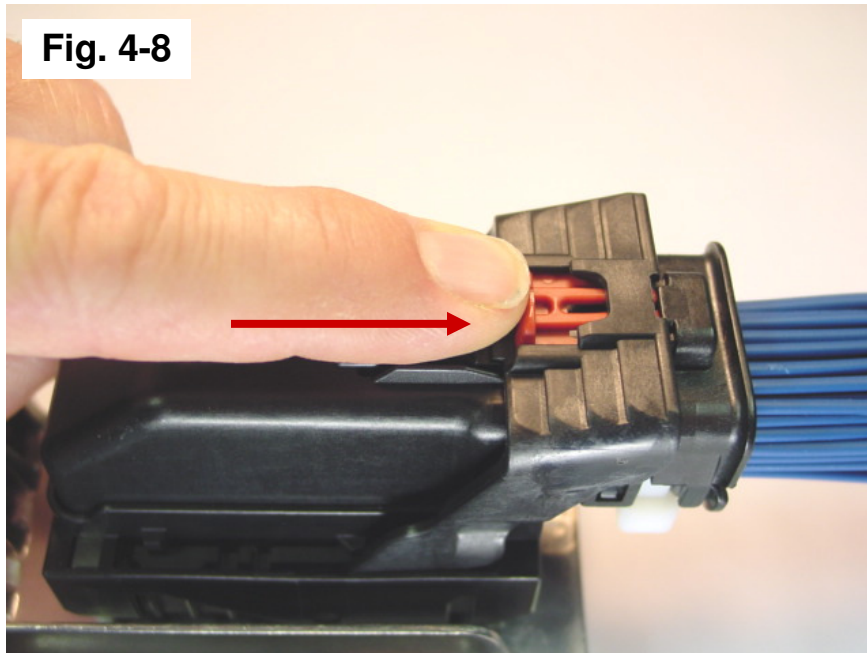

Section 5: Service Instructions

NOTE: For soiled or in-service ECM's, please refer to Section 11 (Appendix B): Cleaning Instructions prior to commencing the following procedures.

A. Harness Connector Removal From Module

- To un-mate the harness connector from the header/controller, push the CPA away from the wire bundle. Depress the primary latch on the top of the harness connector so the lever arm releases from the harness connector (Fig. 5-1).

Primary Latch

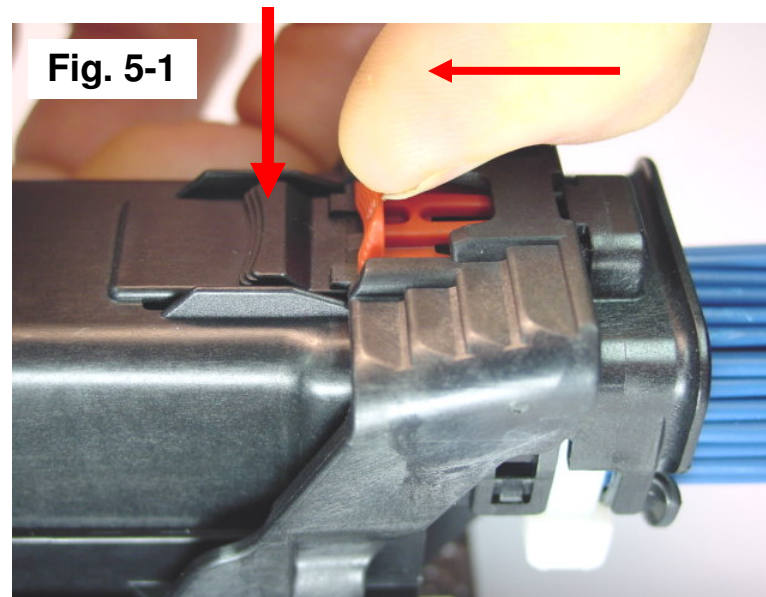

Section 5: Service Instructions

A. Harness Connector Removal From Module (continued)

- Push the top of the mate lever arm away from wire bundle using the palm of your hand (Fig. 5-2).
- Continue to rotate the lever until the connector lifts into pre-lock (Fig. 5-3). The lever **MUST** be in the pre-lock position or the connector can not be easily removed from the module. The lever must be fully forward for the harness connector to be in pre-lock position.

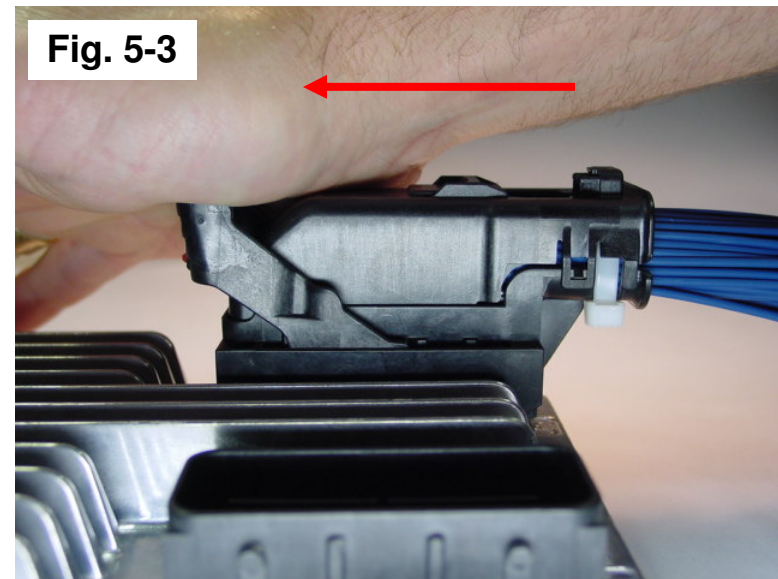
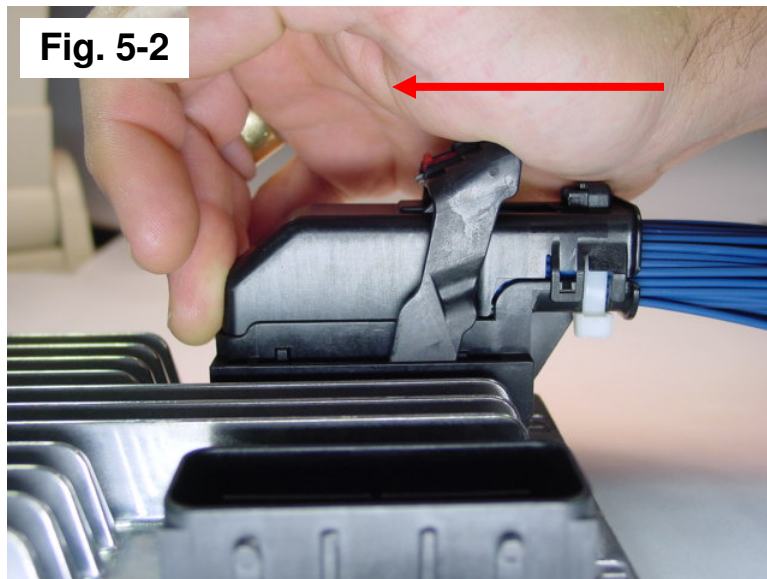

Section 5: Service Instructions

A. Harness Connector Removal From Module (continued)

- While pushing forward on the lever, grip the back of the harness and evenly pull straight upwards and away from the module (Fig. 5-4).

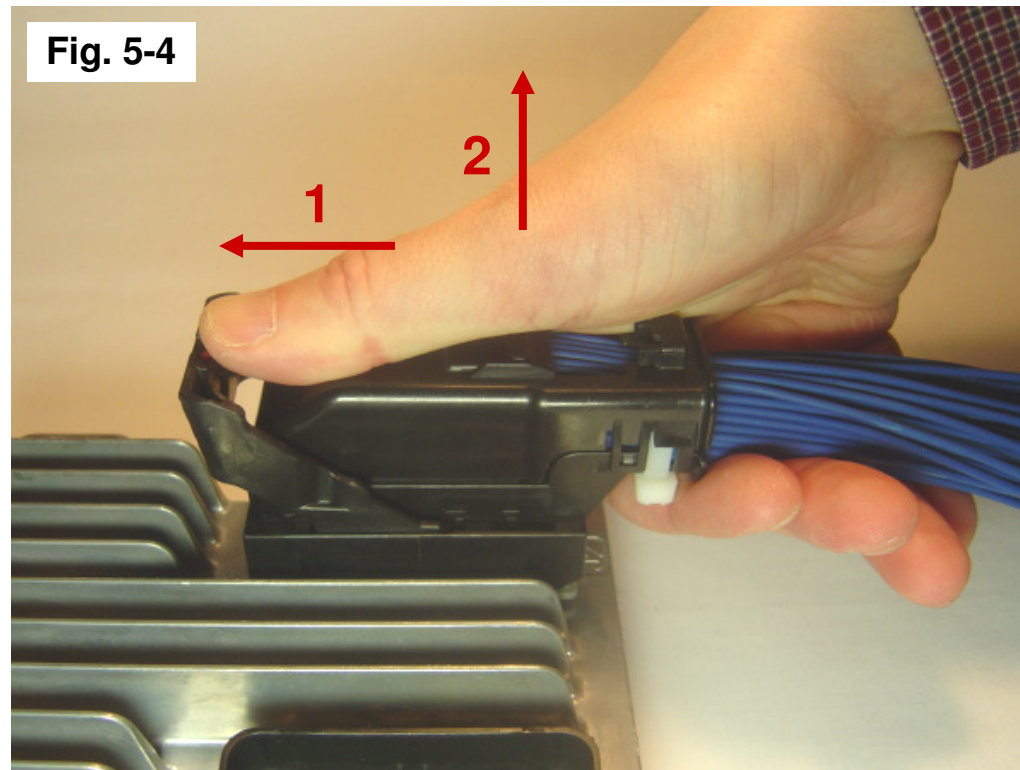

Section 5: Service Instructions

B. Dress Cover Removal

- With the harness connector removed from header/controller (Fig. 5-5), unlatch the dress cover latch features on each side of the dress cover guide (Fig. 5-6). A small screwdriver or similar tool can be used to release the latches.

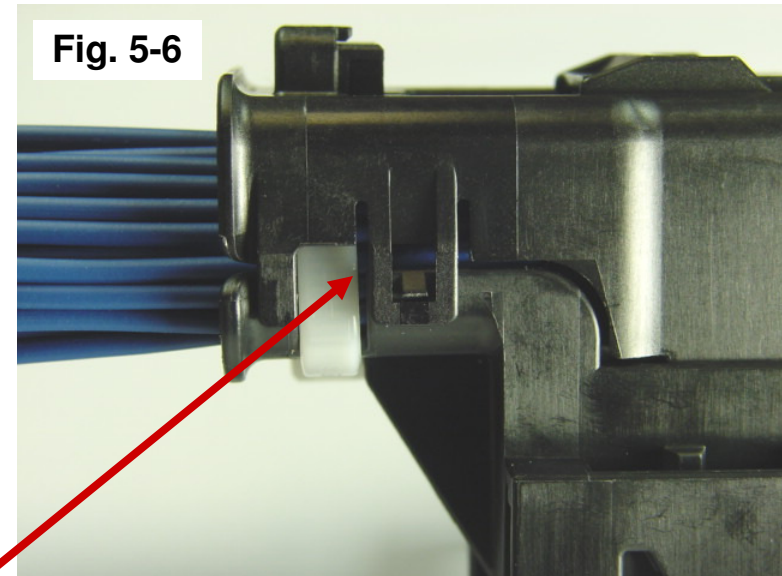
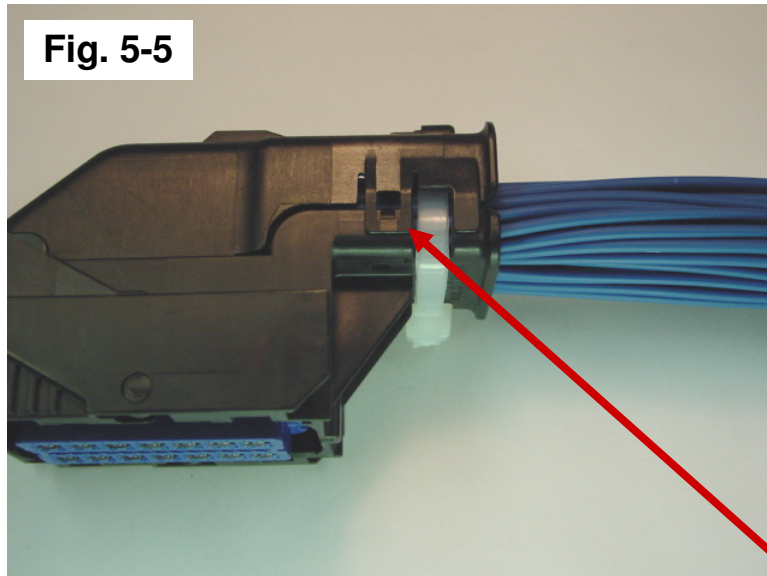

Latch Feature
on each side



Section 5: Service Instructions

B. Dress Cover Removal (continued)

- With the dress cover latch features unlatched, insert your finger into dress cover (Fig. 5-7) and pull up and away from the wire bundle. The dress cover can be completely removed at this point (Fig. 5-8).

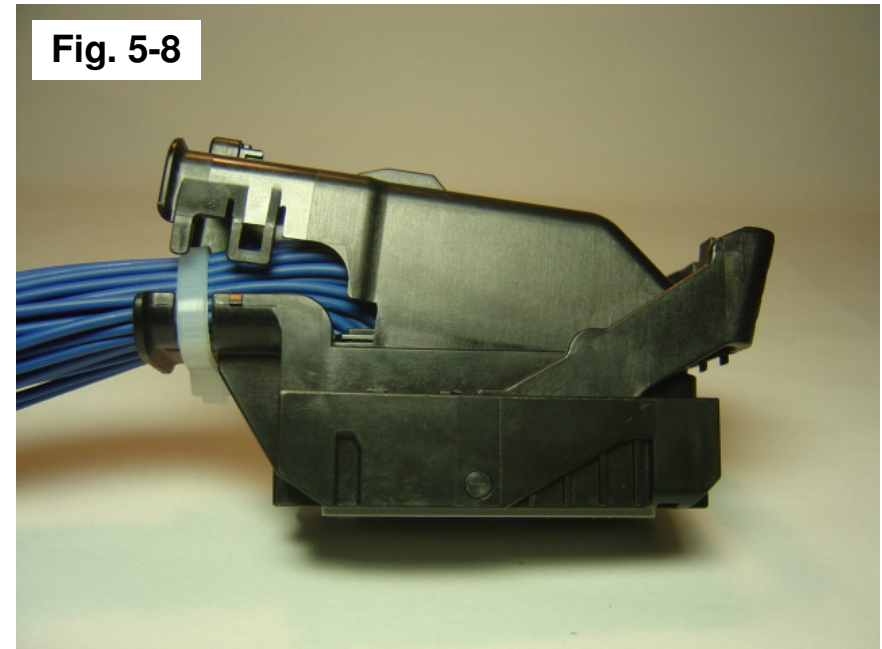
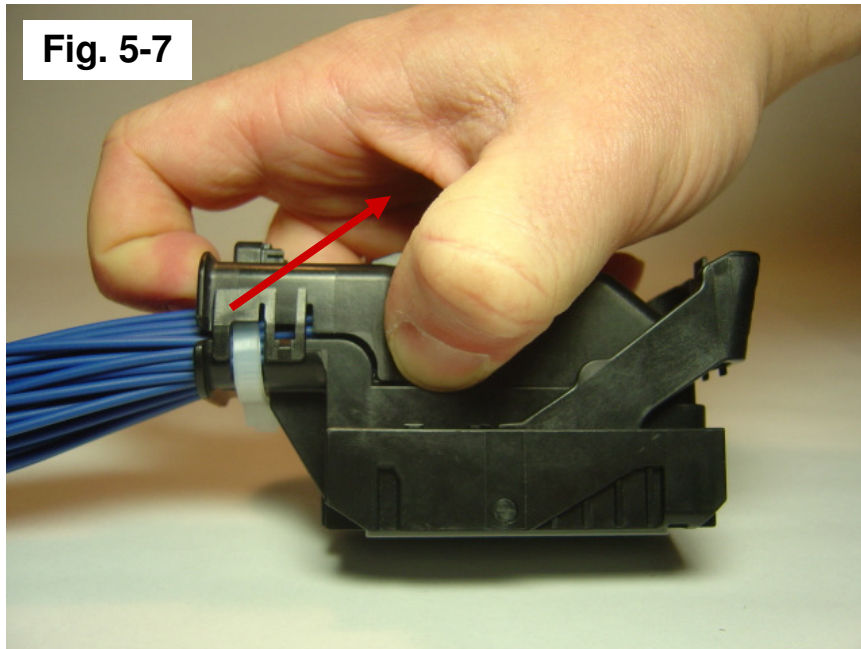

Section 5: Service Instructions

C. Tie-Wrap Removal

- The tie-wrap can now be removed from the wire bundle (Fig. 5-9) for easier access to the wire to be serviced. **The tie-wrap MUST be cut under the wire dress tab to prevent damage to the wires!**

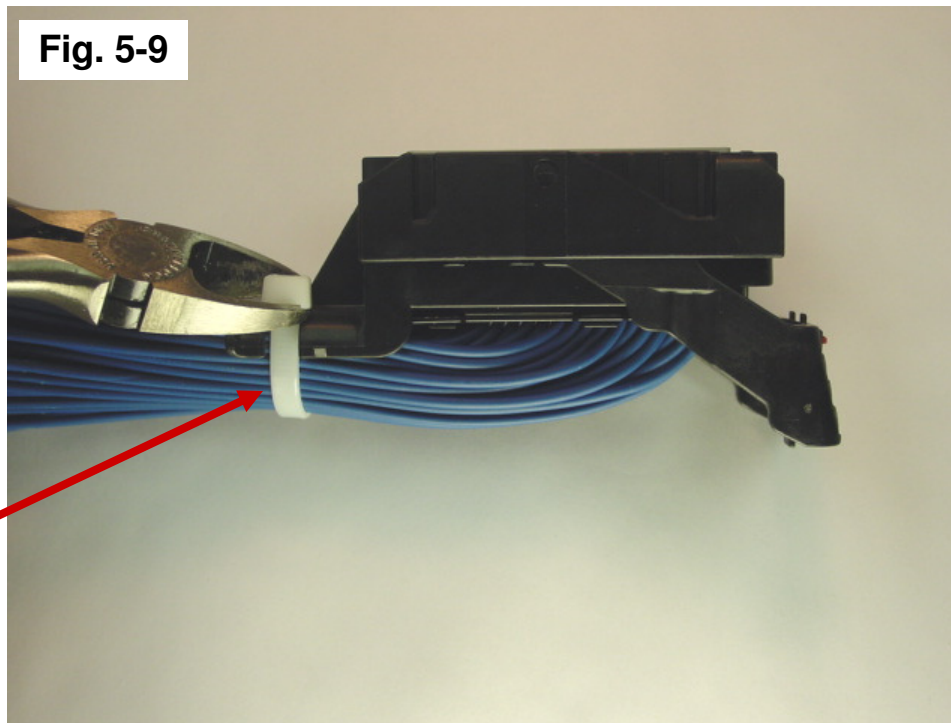

Do not cut near wires!



Section 5: Service Instructions

D. TPA Servicing

- **TPA should never be removed from the connector.**
- **Step 1: Insert a small (2.0mm maximum) flat blade screwdriver into the TPA service hole at one end of the connector (Fig. 5-10) and pry up. The TPA will stop when it reaches its pre-lock position for terminal servicing.**
- **Step 2: On the other end of the TPA, repeat Step 1 (Fig. 5-11) until the TPA reaches its pre-lock position at both ends of the harness connector.**
- **Approximate TPA travel will be 5.0mm (See Figs. 5-12 and 5-13 on next page).**

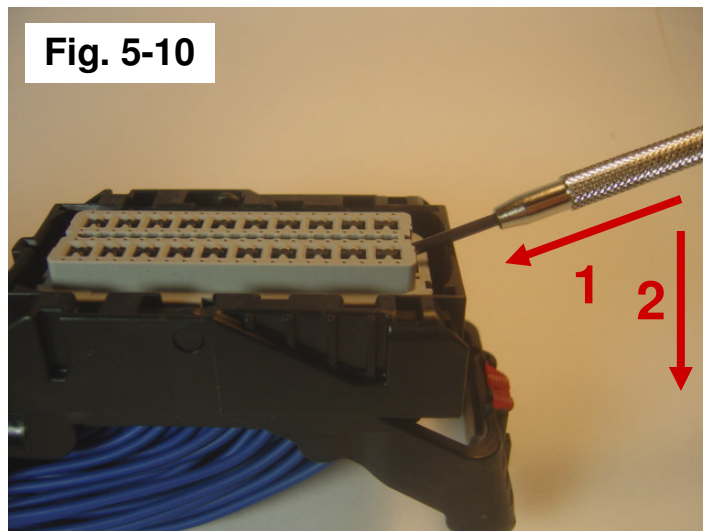

Step 1: Pry up TPA

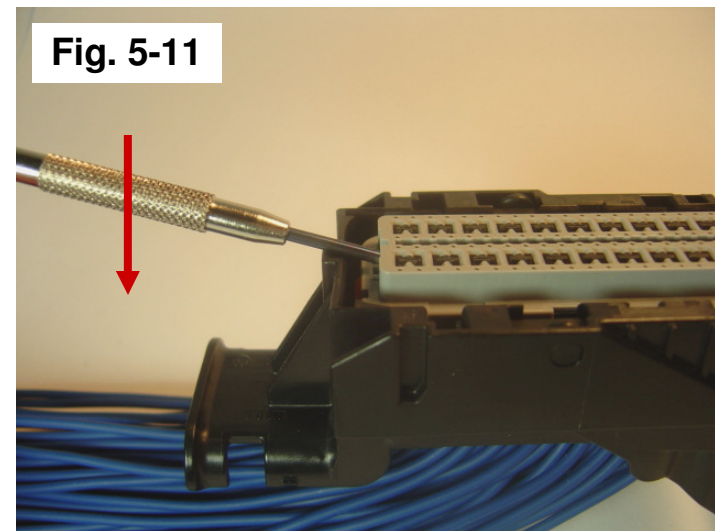

Step 2: Pry up opposite end of TPA



Section 5: Service Instructions

D. TPA Servicing (continued)

Fig. 5-12

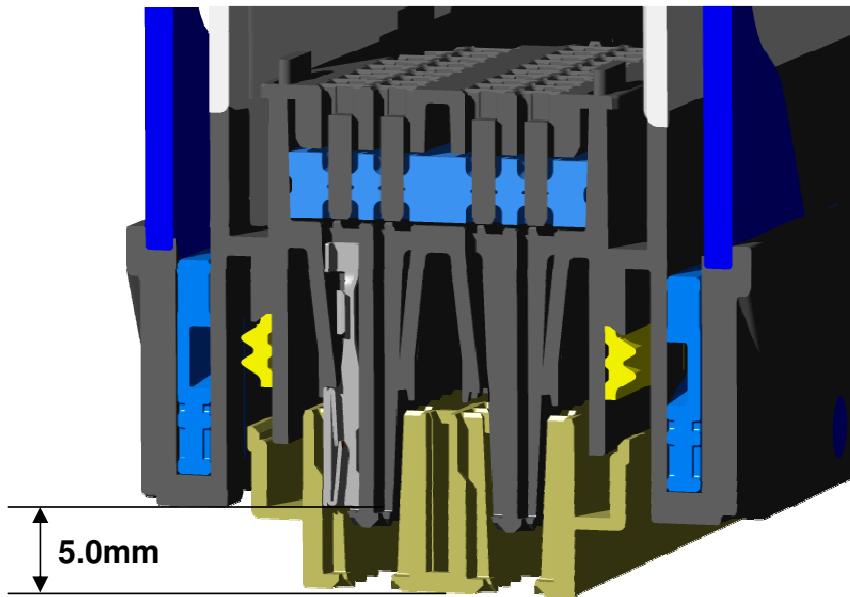
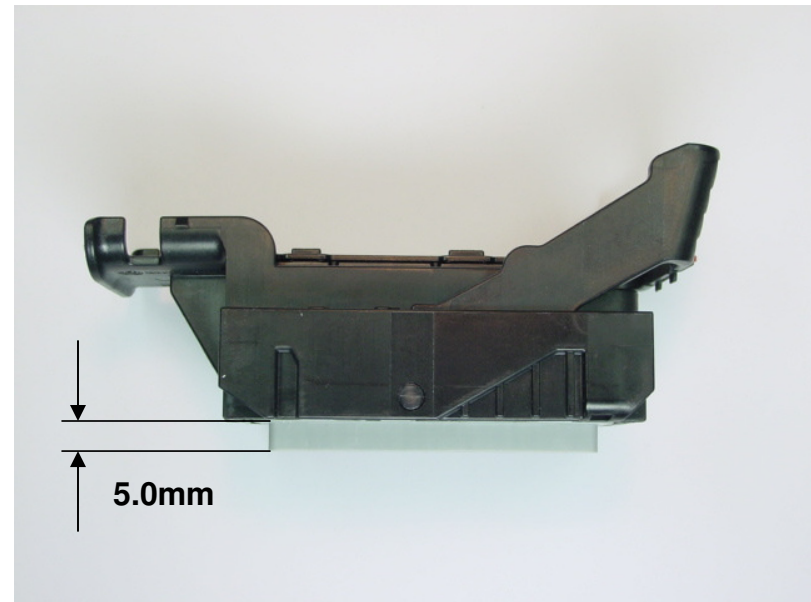

Fig. 5-13



Views of TPA in "Pre-Lock" Position



Section 5: Service Instructions

E. MX64 Receptacle Terminal Removal

- **Ensure TPA is in pre-lock position!**
- Holding the 0.64mm service tool (Fig. 14: Molex part no. 63813-1400 or alternate GM part no. J-38125-213) between middle finger and thumb, with index finger on top of the tool, insert the tip of the tool into the terminal service hole adjacent to the terminal to be serviced (Fig. 5-15).
- After first pushing the wire/terminal forward, use your index finger to push the service tool (Fig. 5-15) until a large amount of resistance is felt. This wedges the service tool between the terminal and the lock finger, therefore deflecting the lock finger. (Fig. 5-16).

Fig. 5-14



Fig. 5-15

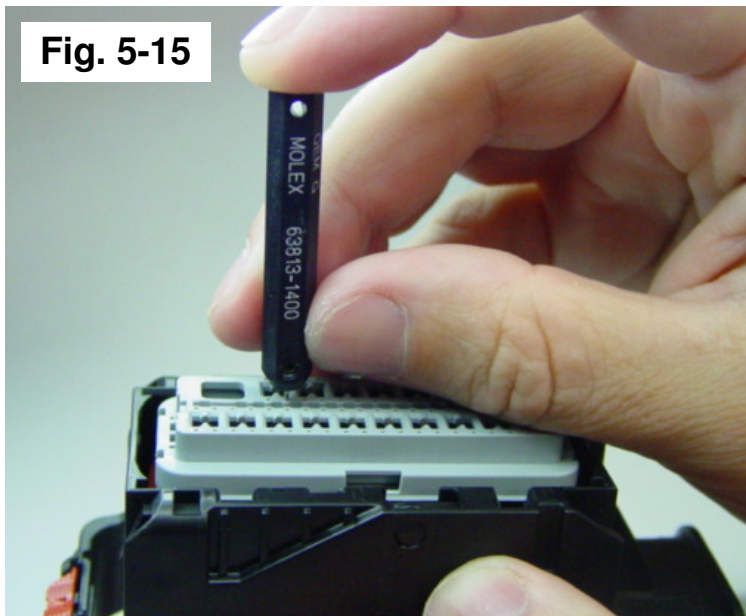
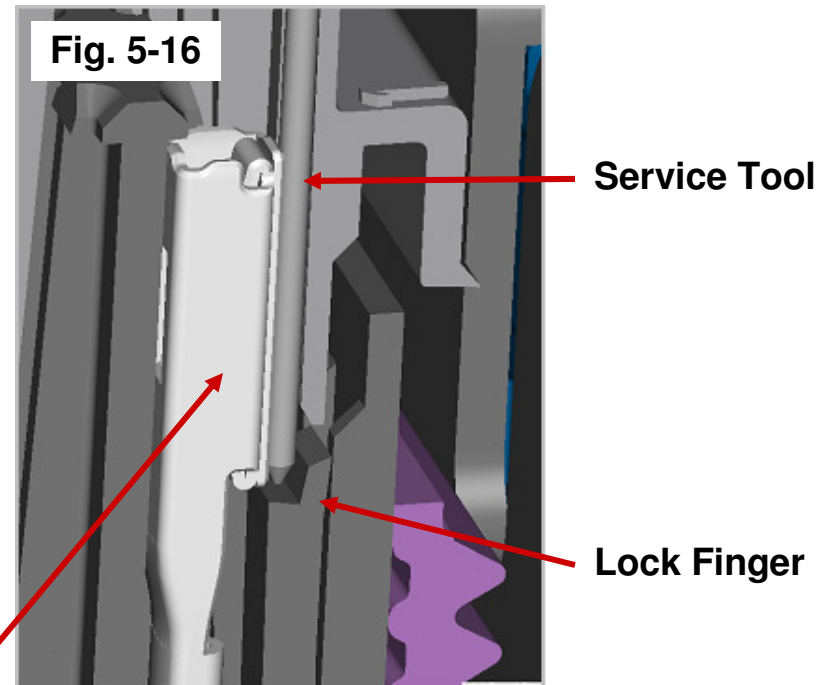

Fig. 5-16



Section 5: Service Instructions

E. MX64 Receptacle Terminal Removal (continued)

- Fig. 5-17a shows proper insertion of the service tool. Avoid inserting the service tool into the terminal opening (Fig. 5-17b) as this may damage the terminal.

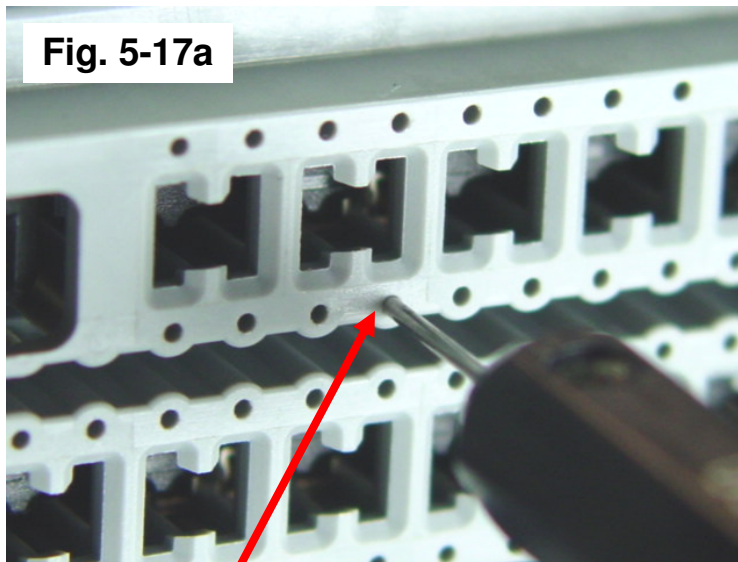

Proper Insertion

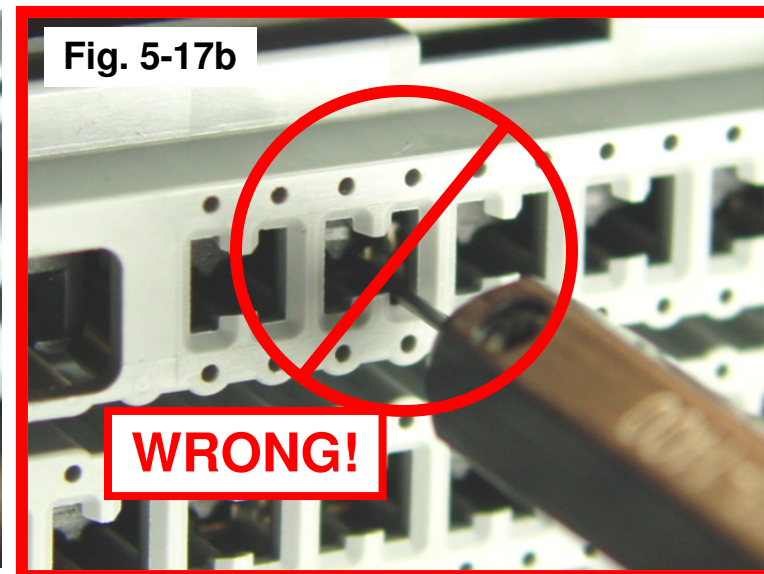

Incorrect Insertion



Section 5: Service Instructions

E. MX64 Receptacle Terminal Removal (continued)

- Once the terminal lock finger has been disengaged, transfer middle finger and thumb to connector housing, while maintaining index finger pressure on the tool. Pull on the wire to remove the terminal (Fig. 5-18). If the terminal resists, the service tool may not be fully engaged. Repeat the servicing instructions, starting at page 33.
- Do not use excessive force. Excessive force can damage the lock finger. Do not apply any lateral force. The lock finger is displaced by linear insertion alone.



Section 5: Service Instructions

F. MX64 Grommet Seal Plug Removal

- Step 1. Remove dress cover to access the 0.64mm grommet seal plugs
- Step 2. Use needle nose pliers to hold head of 0.64mm grommet seal plugs.
- Step 3. Pull grommet seal plug out of back of grommet cap.
- **Do not re-use grommet seal plug once it has been removed!**

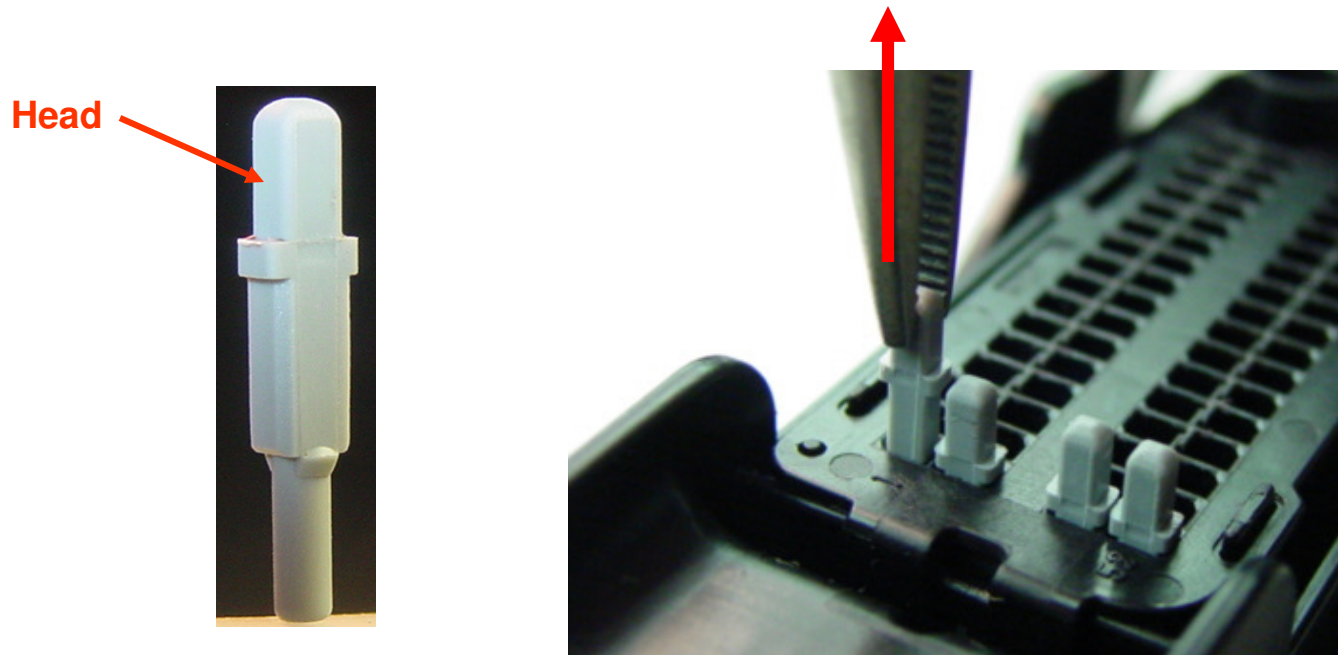

Section 5: Service Instructions

G. 2.80mm Receptacle Terminal Removal

- While pushing the terminal forward, insert the 2.80mm service tool (Yazaki p/n X39899-J374). Insert the tip into the terminal service opening (Fig. 5-19). Avoid inserting the service tool into the terminal opening (Fig. 5-19a). This may cause damage to the 2.80mm terminal.

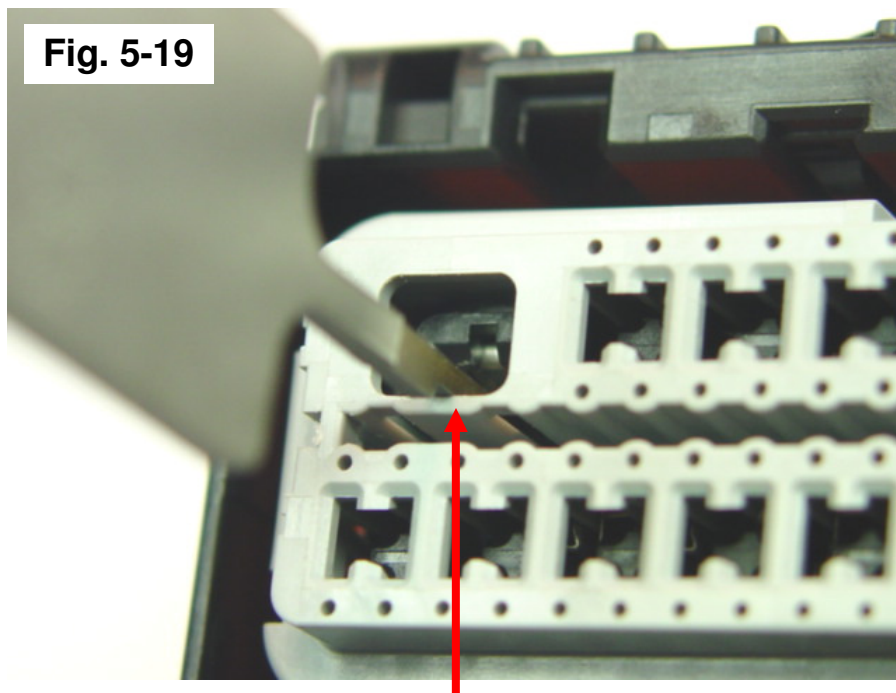

Proper Insertion

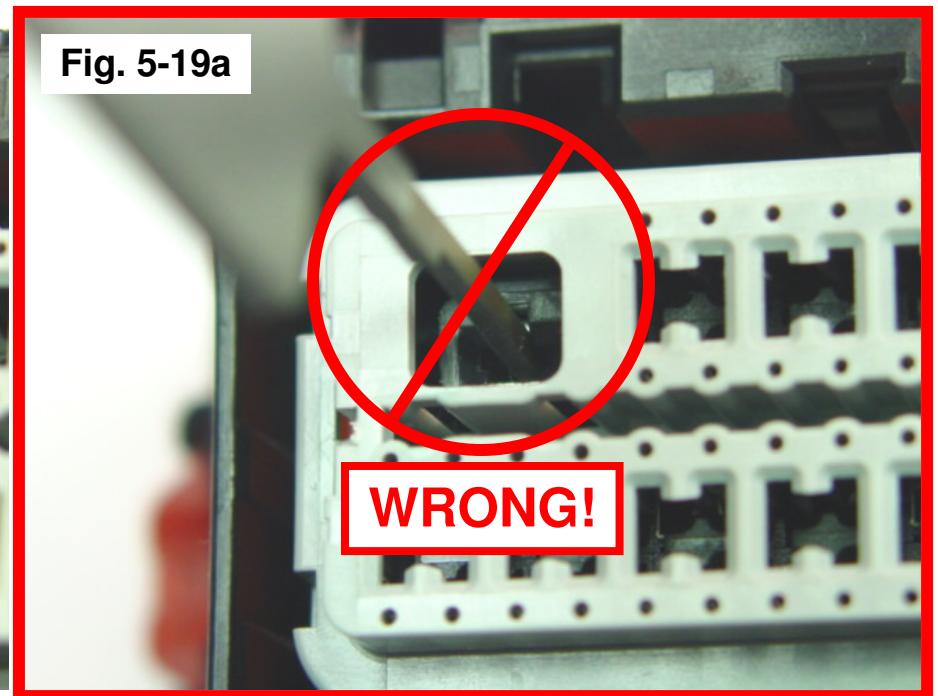

Improper Insertion



Section 5: Service Instructions

G. 2.80mm Receptacle Terminal Removal (continued)

- Once the tool is inserted into the terminal service opening, push the service tool (Fig. 5-20) until it wedges between the female terminal and the lock finger (Fig. 5-21).

Fig. 5-20

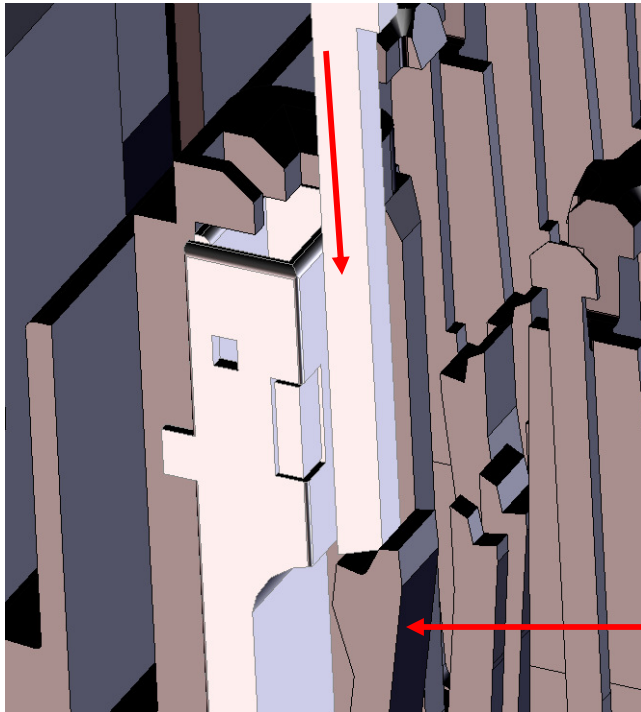
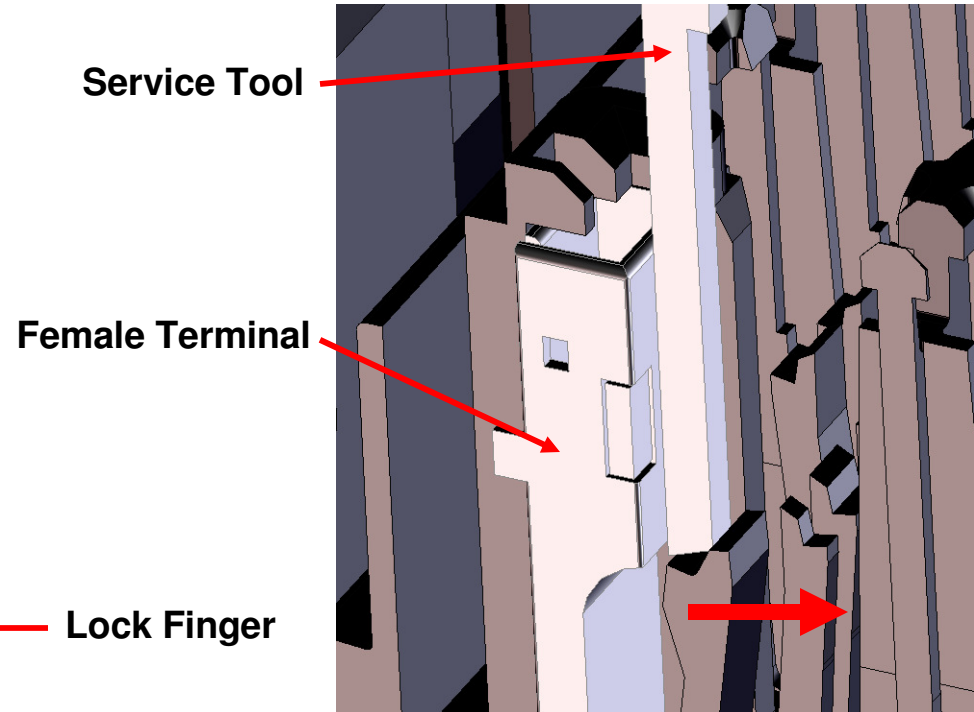

Fig. 5-21



Section 5: Service Instructions

G. 2.80mm Receptacle Terminal Removal (continued)

- Once the terminal lock finger is disengaged, pull on the wire (Fig. 5-22) to remove the terminal. If the terminal resists, the service tool may not be fully engaged. Push the service tool further into the service hole to ensure that it has disengaged the terminal lock finger.

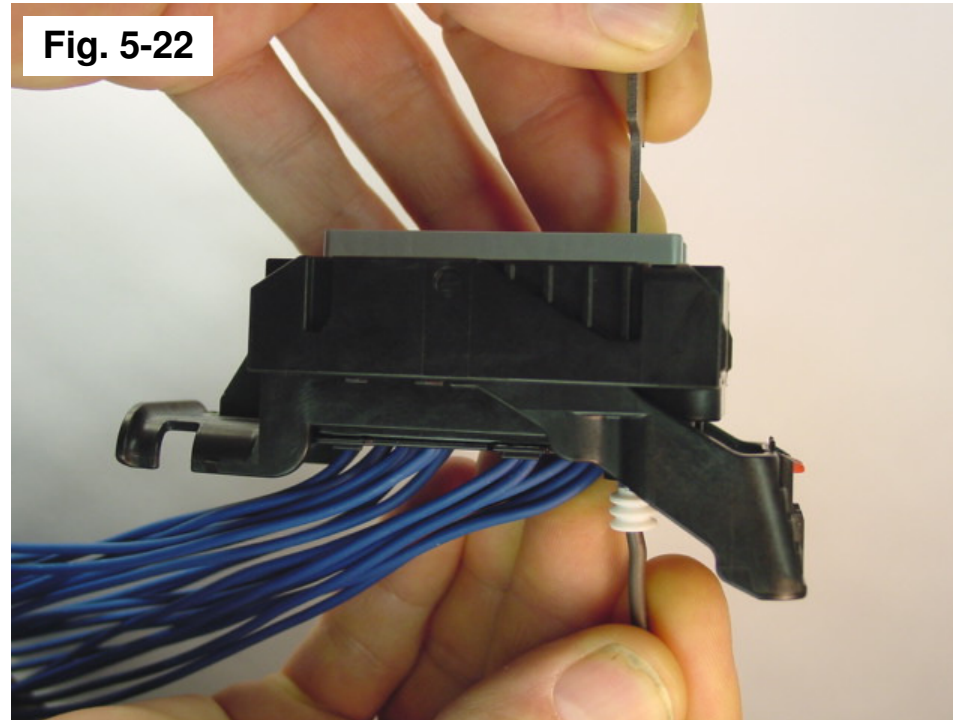

Section 5: Service Instructions

H. Terminal Crimping

- If the 0.64mm receptacle terminal needs to be replaced, a new one can be hand crimped using GM Crimp Tool #XX019825 or Molex Crimp Tool #63811-4200.

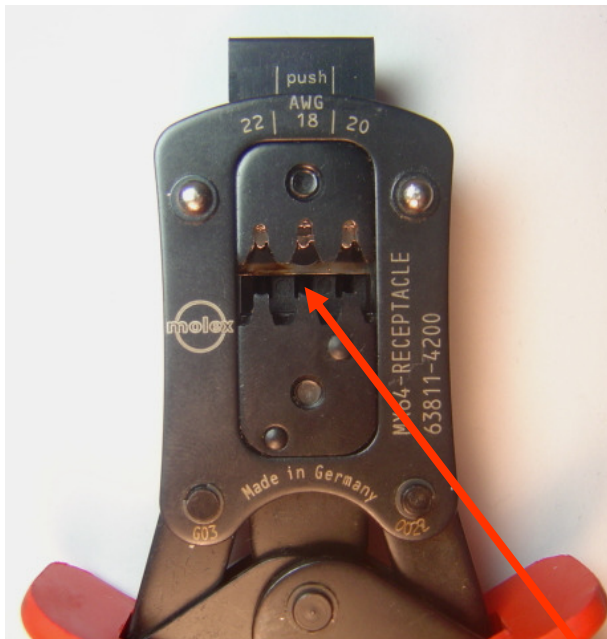

1.) Identify the wire gauge you need to crimp. Notice the rectangular shape of the terminal cavity.



2.) Insert the correct terminal and press the wire-stop down.

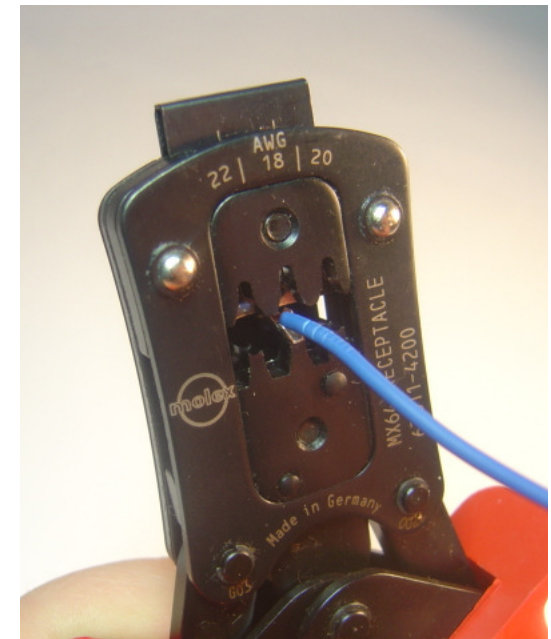

3.) Insert the wire until the wire hits the wire stop. Squeeze the handles through the last "click" until they release.



Section 5: Service Instructions

I. Terminal Crimping (continued)

- Contact Molex for terminal sales drawings. Hand crimp instructions, strip length recommendations, and crimp height requirements are available in the Molex Spec. Sheet for Tool #63811-4200.
- If the Yazaki 2.80mm receptacle terminal needs to be replaced, a new one can be hand crimped with the appropriate cable seal using crimp tools #J-38125-6 and #J-38125-7. These tools can be ordered from SPX Kent-Moore (1-800-345-2233).

J. Completing Assembly of Serviced Product

- For steps required to complete the assembly of this product, please refer to Section 3 of this manual.



Section 6: Electrical Continuity Checking

A. Pogo Pin Recommendation - 0.64mm Terminal

- Pogo Pin Specification – See next page.

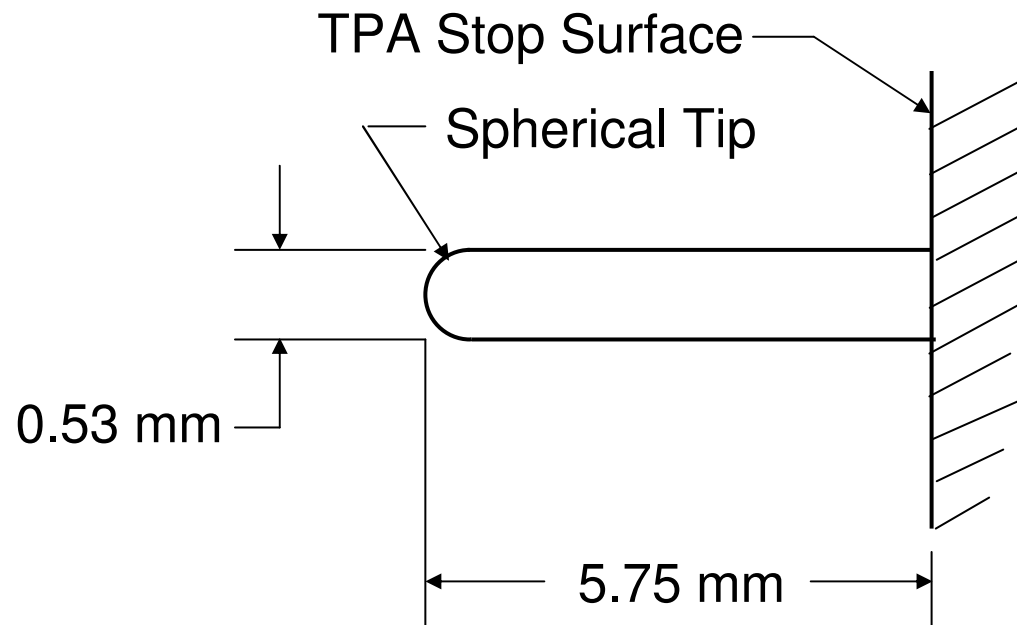

Section 6: Electrical Continuity Checking

A. Pogo Pin Recommendation - 0.64mm Terminal (continued)

Probe Pin Details (0.64mm terminal)

Manufacturer: Lone Star Industrial

Part number: LS040RS-ELW-277-N-4.7

Pin diameter: 0.020" (0.53 mm)

Tip shape: Spherical

Tel: (915) 779-7255

Ordering Example: LS040RS-ELW-277-N-4.7
Plunger Plating - Spring Force _____

TECHNICAL DATA		
Minimum Centers:	.075 (1.91)	
Working Travel:	.070 (1.78)	
Current Rating:	3 Amps	
MATERIALS		
Plunger:	Heat Treated BeCu, Gold or Nickel Plated.	
Barrel:	Brass, Gold Plated.	
Spring:	Stainless Steel or Music Wire.	
Seal Ball:	Chrome Steel.	
Receptacle:	Nickel Silver, Gold Plated.	
SPRING FORCE		
	OZ. (GRM) at .070 (1.78) Travel	PRELOAD
Standard	4.7 (133)	1.4 (40)

Dimensions in inches (millimeters)

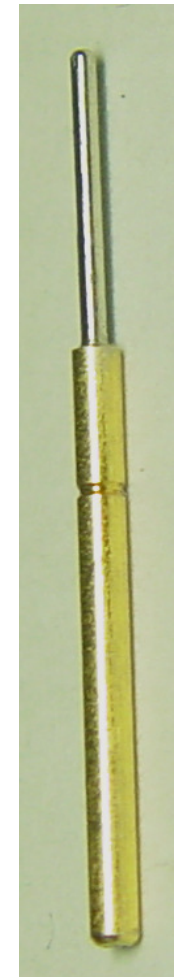

POGO PIN



Section 6: Electrical Continuity Checking

B. Pogo Pin Recommendation – 2.8mm Terminal

- Pogo Pin Specification – See next page.

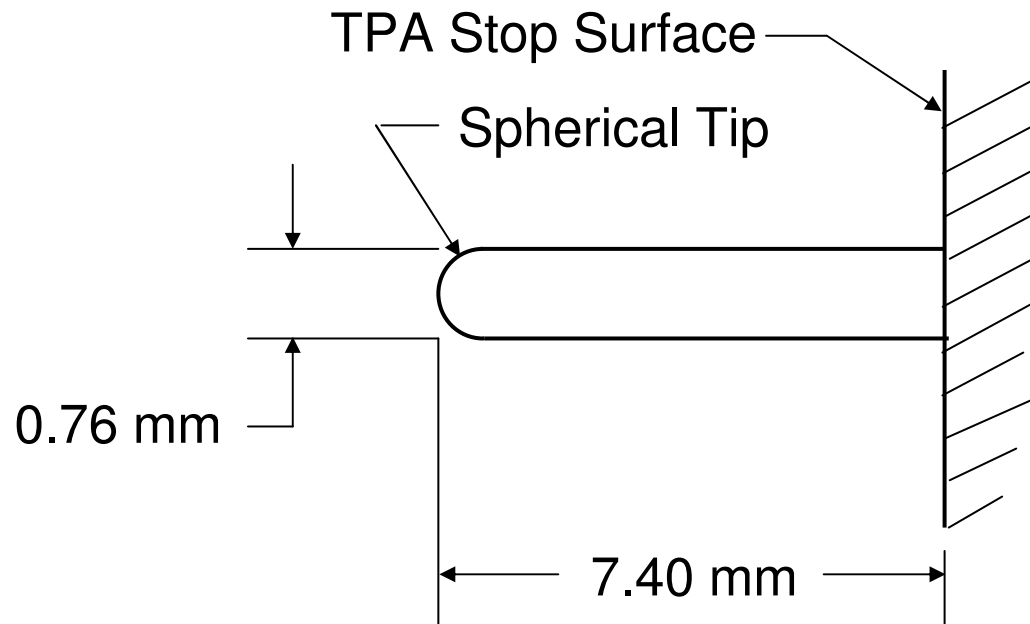

Section 6: Electrical Continuity Checking

B. Pogo Pin Recommendation – 2.8mm Terminal (continued)

Probe Pin Details (2.8mm terminal)



Manufacturer: Lone Star Industrial

Part number: LS054RS-ELW314

Pin diameter: 0.030" (0.76mm)

Tip shape: Spherical

Tel: (915) 779-7255

Ordering Example: LS054RS-ELW314		
TECHNICAL DATA		
Minimum Centers:	.100 (2.54)	
Working Travel:	.105 (2.67)	
Current Rating:	4 Amps	
MATERIALS		
		G  N 
Plunger:	Heat Treated BeCu, Gold or Nickel Plated.	
Barrel:	Brass, Gold Plated.	
Spring:	Stainless Steel or Music Wire.	
Seal Ball:	Chrome Steel.	
Receptacle:	Nickel Silver, Gold Plated.	
SPRING FORCE		
	OZ. (GRM) at .105 (2.67) Travel	PRELOAD
Standard	3.7 (105)	1.7 (48)

Dimensions in inches (millimeters)

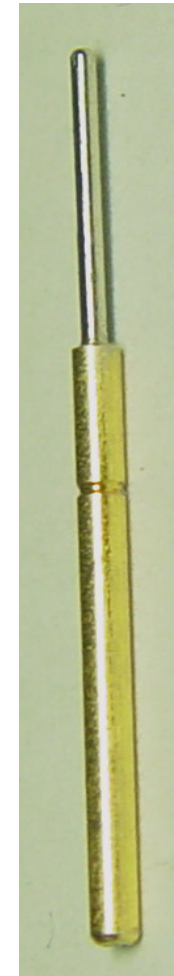

POGO PIN



Section 6: Electrical Continuity Checking

C. Pogo Pin Layout Recommendation (73-way)

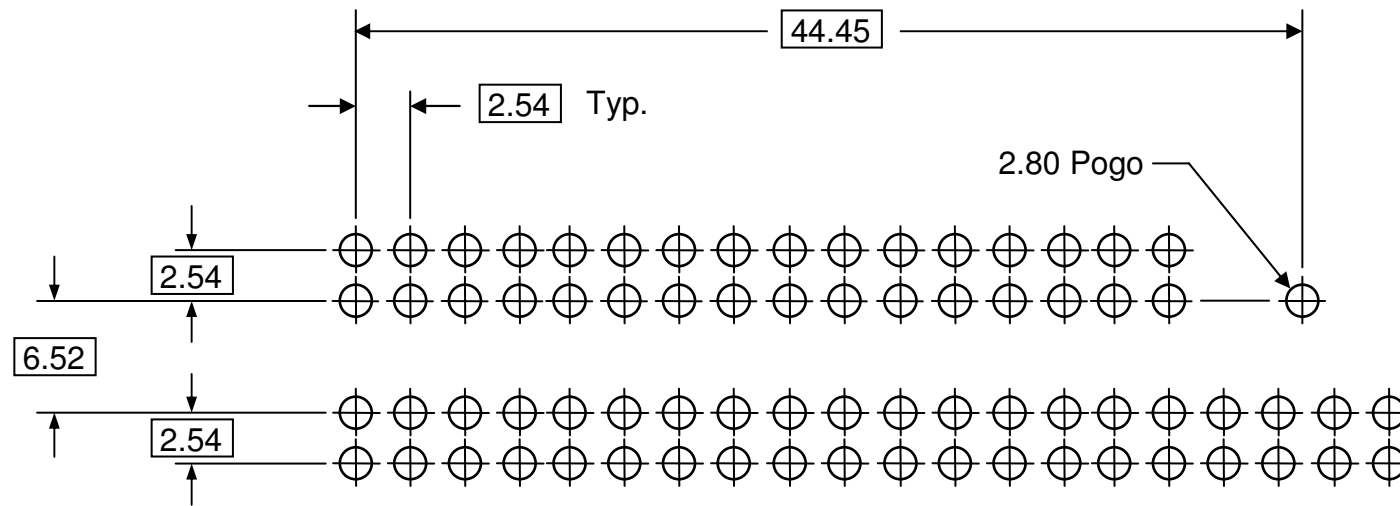

Test Pogo Pin Probing Array



Section 6: Electrical Continuity Checking

D. Pogo Pin / Probe Opening

- Check electrical continuity on the terminal by inserting probe pin down the center of receptacle TPA opening.

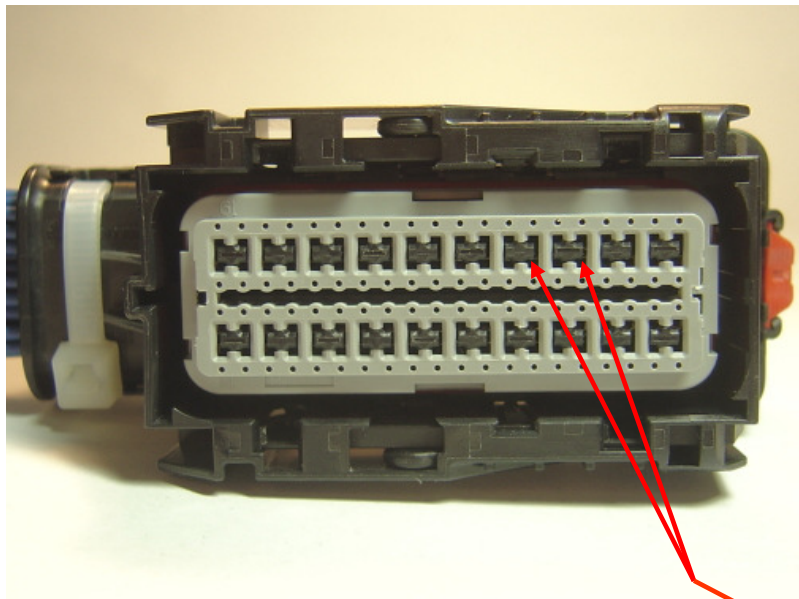

Molex Receptacle connector

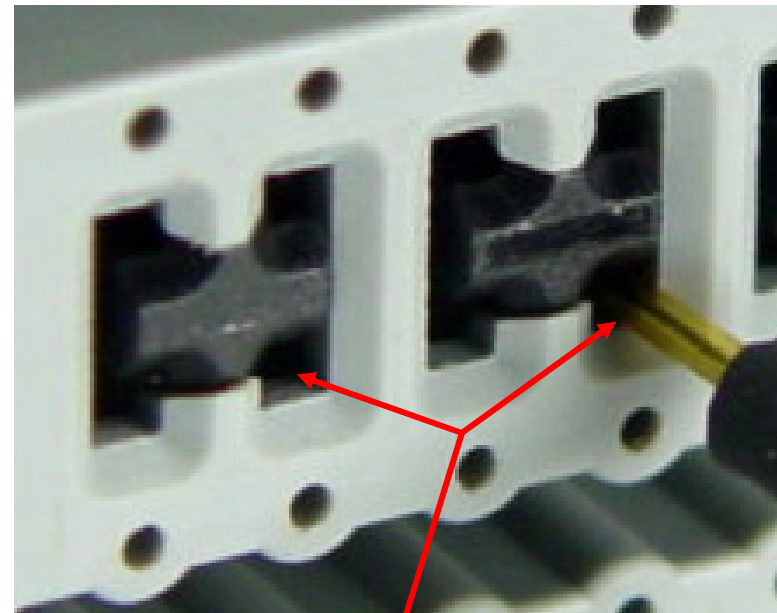

Opening for probe pin/male terminal



Section 6: Electrical Continuity Checking

E. Recommendations

When testing the connector for continuity, it is imperative that you do not damage the terminals!

Pogo pins should be checked for damage or sticking several times a shift:

- First, a visual inspection of all the pins for damage should be performed.
- Next, a testing block should be used to depress all the pogo pins up into the barrel. If there is a bent or sticking pin, it should remain stuck in the barrel of the pogo pin. A damaged or stuck pin should be replaced before any additional testing is performed.

Probing damage can occur...

- If a sharp-ended probe is inserted into the terminal. This may damage the plating and increase contact resistance.
- If an oversized diameter probe is inserted into the terminal. This will overstress the beam in the terminal, creating an environment for intermittent contact and/or increased electrical resistance.
- If a probe is inserted into the terminal at an angle or off center. This may damage the terminal and/or the connector.



Section 6: Electrical Continuity Checking

F. Manual Probing of the Connector

- If the connector must be probed off-line, please use:
 - GM probe tool #J-35616-64B for the 0.64mm terminal, and #J-35616-65B for the ECM pins. (Fig. 6-1).
 - GM probe tool # J-35616-4A for the 2.80mm terminal (Fig. 6-1).
- Insert the probe through the terminal opening as shown in Fig. 6-2.

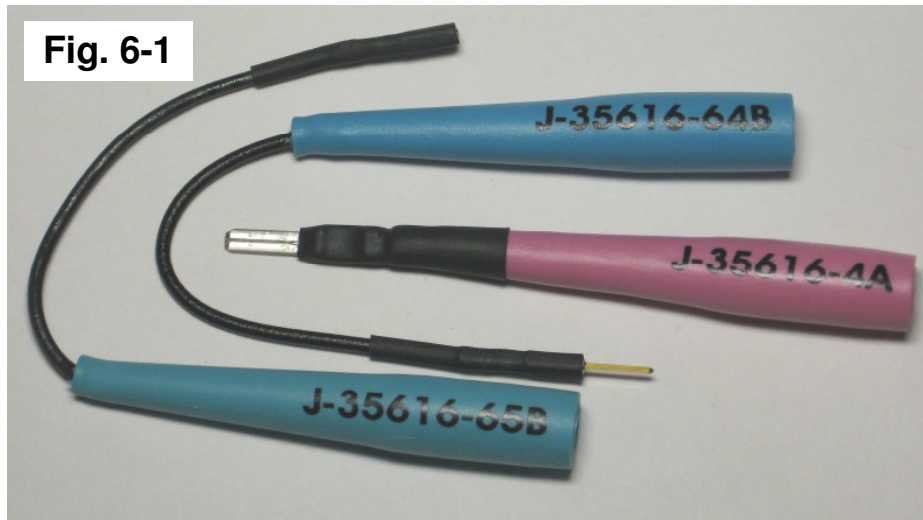

Fig. 6-1

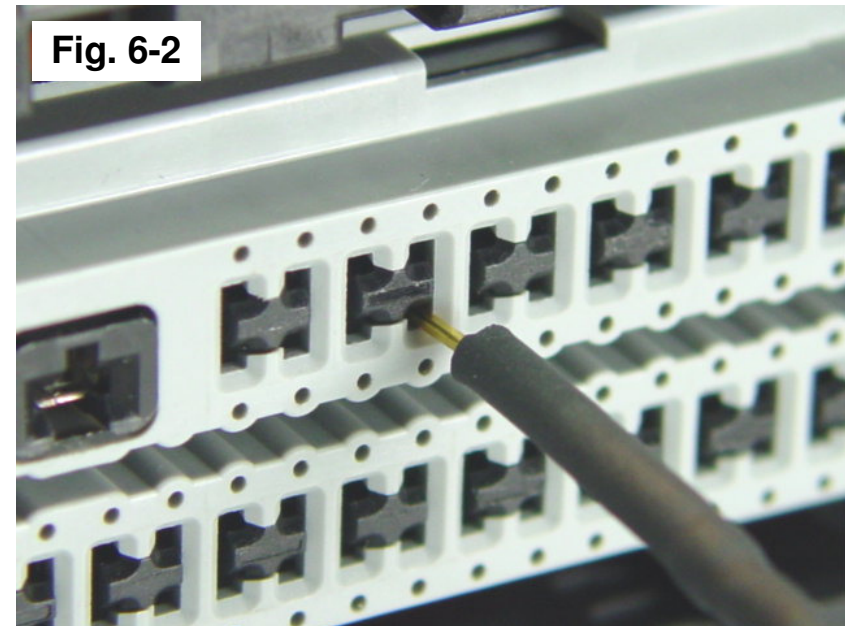

Fig. 6-2



Section 6: Electrical Continuity Checking

F. Manual Probing of the Connector

Manual probing damage can occur...

- If a probe is inserted into the back of the connector. This may damage the wire seal, creating an environment for fluid ingress.

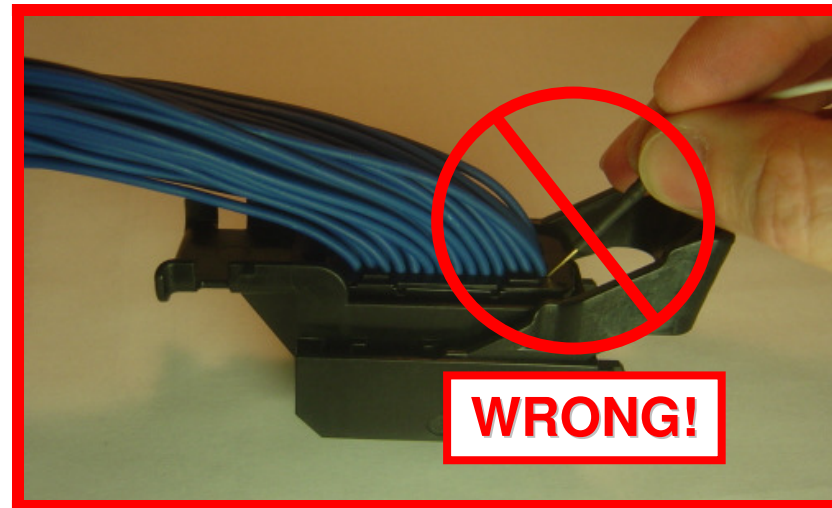

- If the wire insulation is pierced or chafed. This may create a leak-path for fluid ingress and/or wire corrosion.



Section 7: Tool Ordering Information

- Contact your Molex Inside Sales Representative at (800) 786-6539.
- For electronic copies and future updates of this document, refer to the Molex Website at <http://www.molex.com/ind/mx123.html>.

Tool Description	Molex Part No.	GM or Supplier Part No.
0.64mm Service Tool	63813-1400	XX019826
2.80mm Service Tool	-	Yazaki P/N X39899-J374
0.64mm Probe Tool	-	J-35616-64B, J-35616-65B
2.80mm Probe Tool	-	J-35616-4A
0.64mm Hand Crimp Tool	63811-4200	XX019825
2.80mm Hand Crimp Tool	-	J-38125-6 : SPX #12085270 J-38125-7 : SPX #12085271



Section 8: Revision History

Revision Level	Publication Date
B	Oct 22, 2009
9 (same as revA)	Dec 1, 2006
8	July 22, 2005
7	Feb 15, 2005
6	Aug 20, 2004
5	Jan 16, 2004
4	Oct 13, 2003
3	Sept 15, 2003
2	Sept 5, 2003
1	June 16, 2003



Section 9: Files

- UG Models Available Through GM IMAN
- Molex Drawings Available Through Molex Sales

Section 10 (Appendix A): Document Change History

- Rev 1: Initial Release
- Rev 1 to Rev 2:
 - Modified the Connector Mating and Unmating Procedure
 - Updated and Released Only Sections 4 and 5
- Rev 2 to Rev 3:
 - Updated the Connector Mating and Unmating Procedure Based on Customer Input
 - Updated and Released Only Sections 4 and 5
- Rev 3 to Rev 4:
 - Incorporated the Connector Modified Mating Procedure into the Full Reference Manual
- Rev 4 to Rev 5:
 - Revised Section 4 – Connector Mating Instructions
 - Revised Section 5 – Service Instructions
 - Added Appendix A – Document Change History
 - Added Appendix B – Connector Mating Instructions – Modified Mating Procedure
 - Added Appendix C – Service Instructions – Modified Unmating Procedure
- Rev 5 to Rev 6: Production Copy
 - Revised All Sections for Production Release
- Rev 6 to Rev 7:
 - Revised Multiple Sections with Formatting Updates .
 - Revised Section 5: Terminal Crimping.
 - Revised Section 5: Harness Connector Removal from Module.
 - Revised Section 6. Added Pogo Pin and Probing Recommendations.
 - Added Section 7: Tool Ordering Information.
- Rev 7 to Rev 8:
 - Revised Section 2: Product Summary
 - Revised Section 5: Servicing Instructions
 - Added Appendix B: Cleaning Instructions



Section 11 (Appendix B): Cleaning Instructions

STEP 1: While the ECM connection is secure, use a small squirt bottle to squirt water liberally and directly onto the connector slides and around all exposed surfaces, top and bottom, to loosen dirt, grit, and small rocks. The area around the CPA and primary latch should also be sprayed off. The more water used, the cleaner it will become. Do not attempt to un-mate any connectors until Step 4.

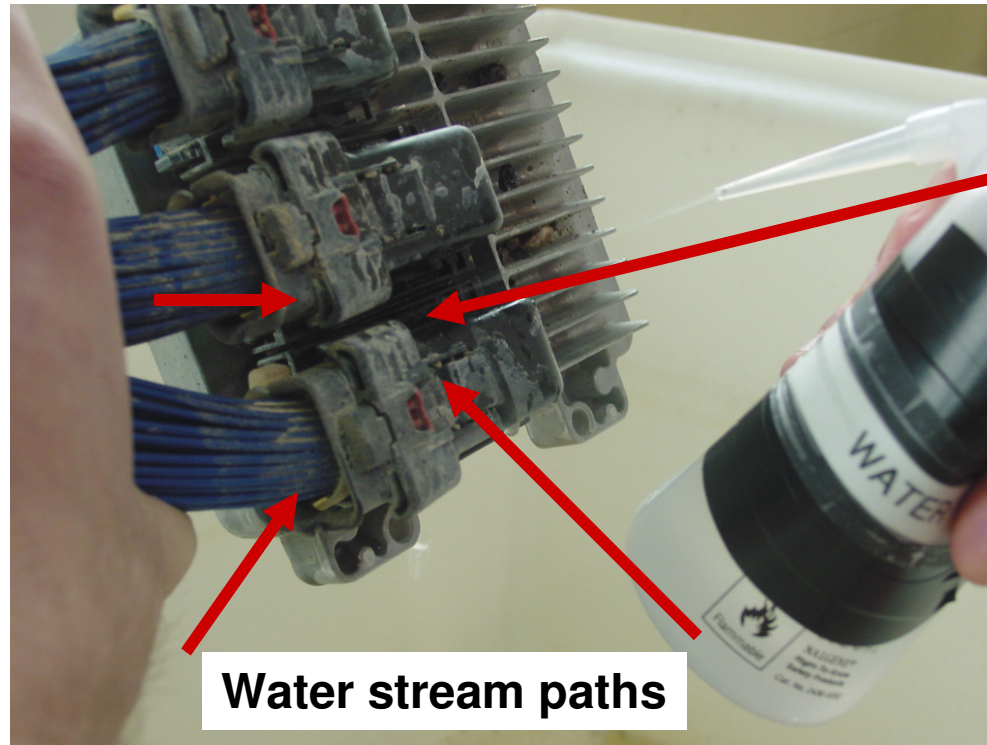

Repeat Step 1 until there is no visual evidence of dirt, grit, or other debris.



Section 11 (Appendix B): Cleaning Instructions

STEP 2: Use high pressure air to remove loosened debris. Direct air pressure around connector slides and all exposed surfaces, top and bottom. When done, ECM and connectors should be visibly dry and debris free. Do not attempt to un-mate any connectors until Step 4.

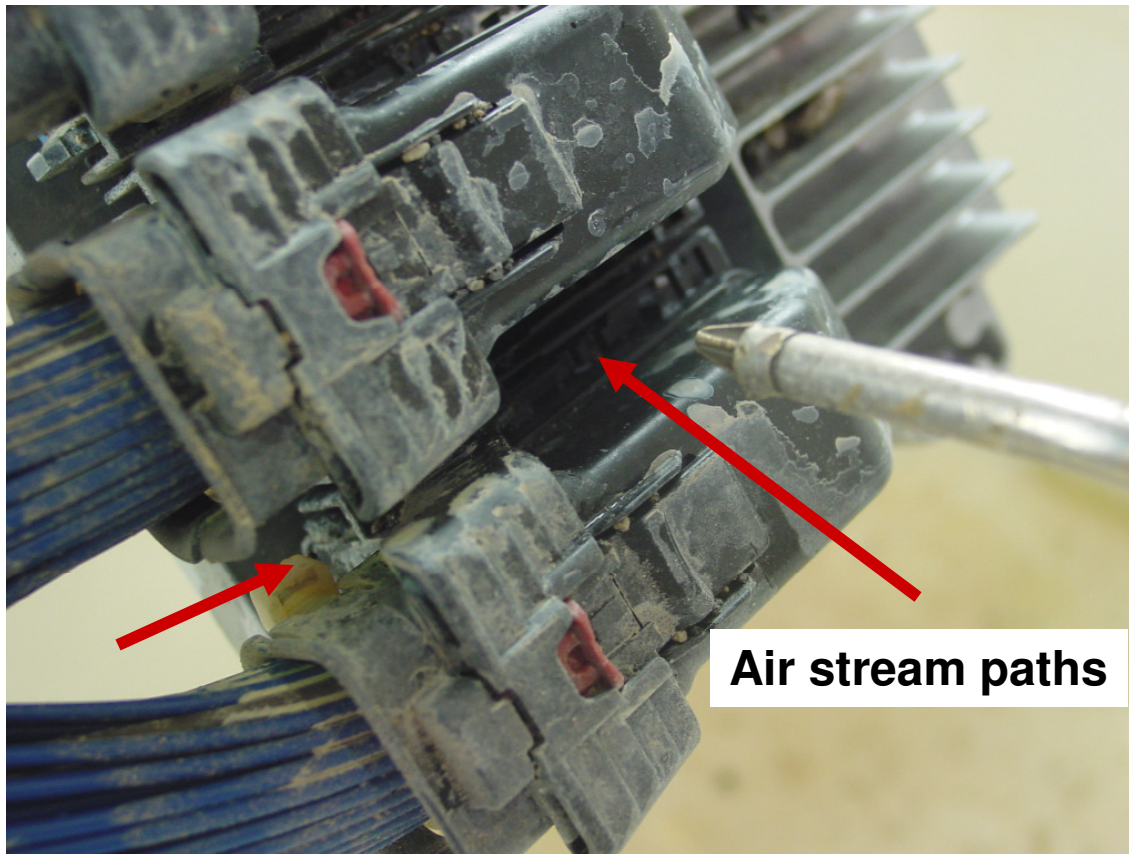

Repeat Step 2 until there is no visual evidence of dirt, grit, or other debris.



Section 11 (Appendix B): Cleaning Instructions

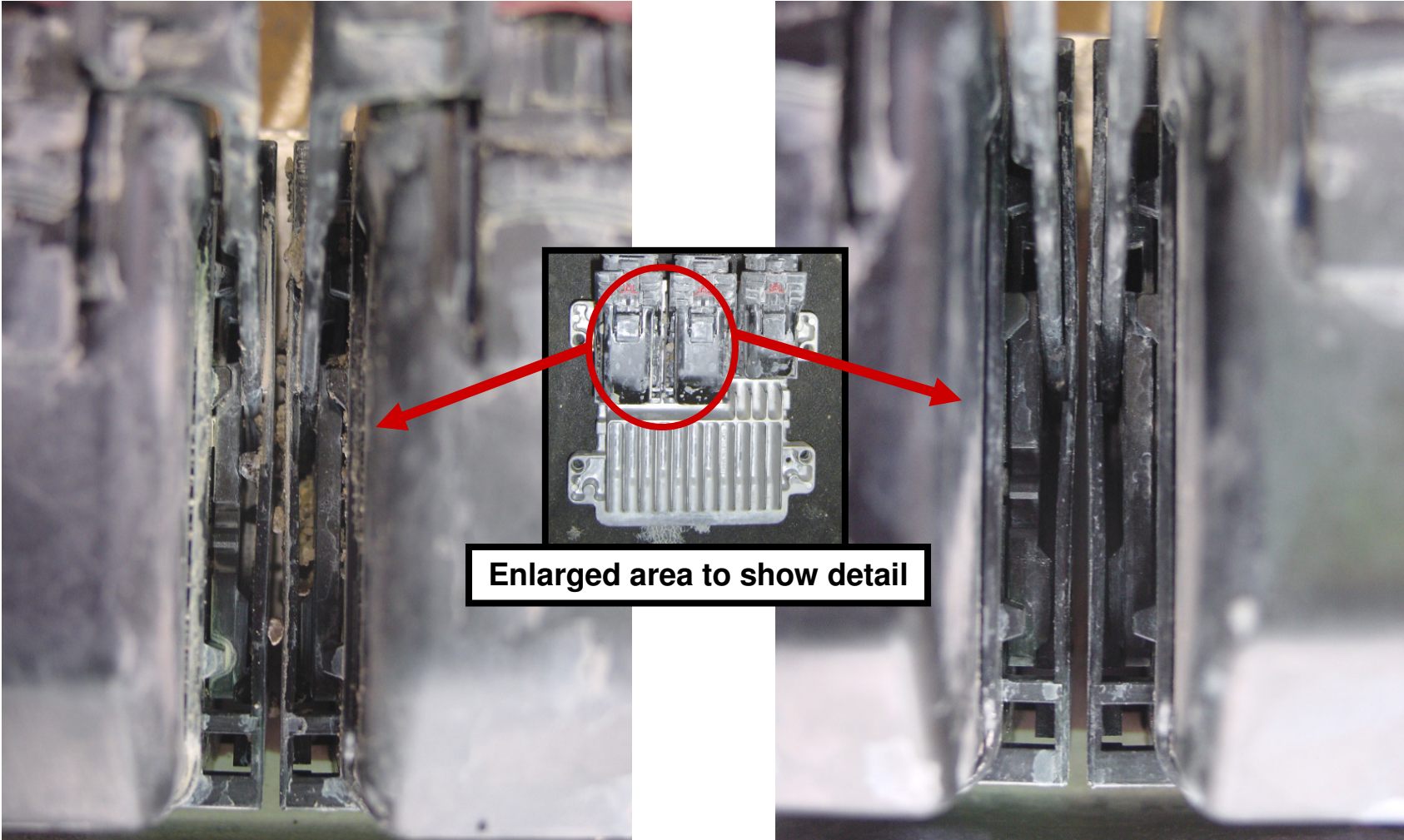

“Gritty” slides

“Clean” slides

Section 11 (Appendix B): Cleaning Instructions

STEP 3: Carefully remove any remaining debris from the slide area with a small brush. Do not attempt to un-mate any connectors until Step 4.

STEP 4: You will need to start to cycle the lever arm to determine if you have excessive resistance. If lever arm binds, or resistance is felt. Repeat steps 1, 2, and 3 until the connector is visibly clean and offers little resistance to un-mating.

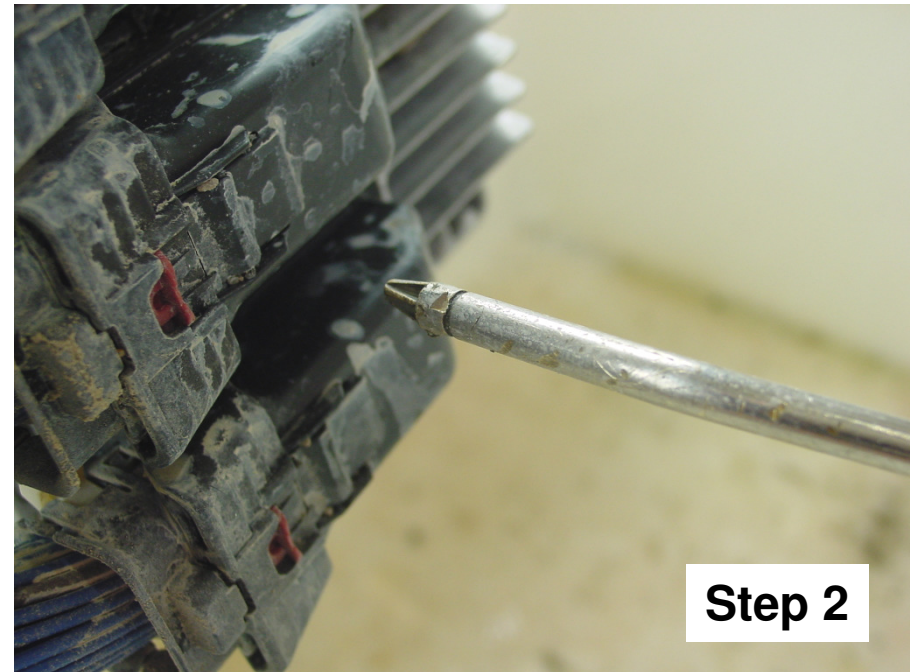
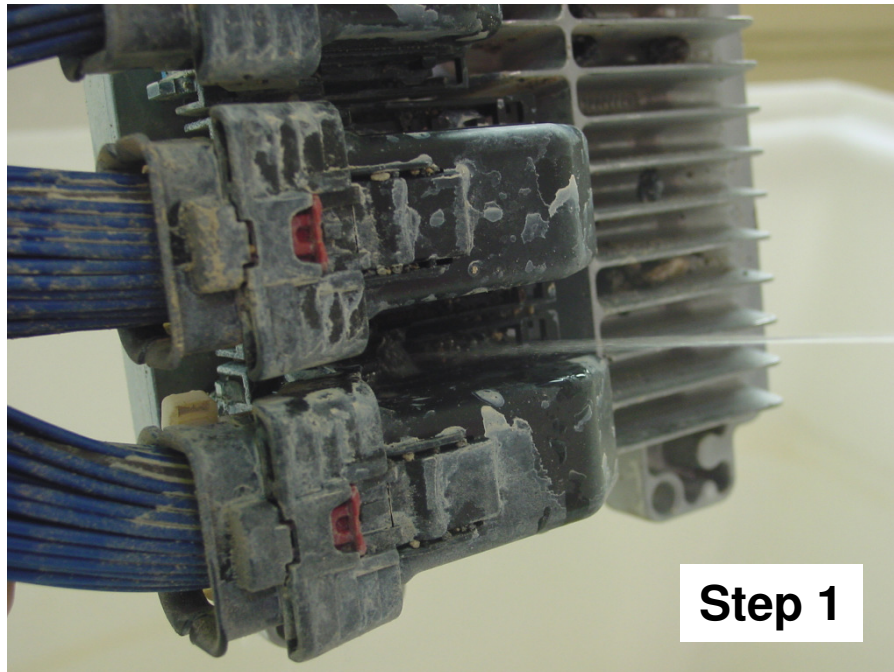

Section 11 (Appendix B): Cleaning Instructions

STEP 5: If excessive resistance is felt while un-mating the connector, continue cleaning connector with the lever arm raised to the point of resistance as shown below. Rotating the lever arm back and forth will help loosen additional debris.

STEP 6: Repeat Steps 1 through 5 until you can un-mate the connector with little resistance.

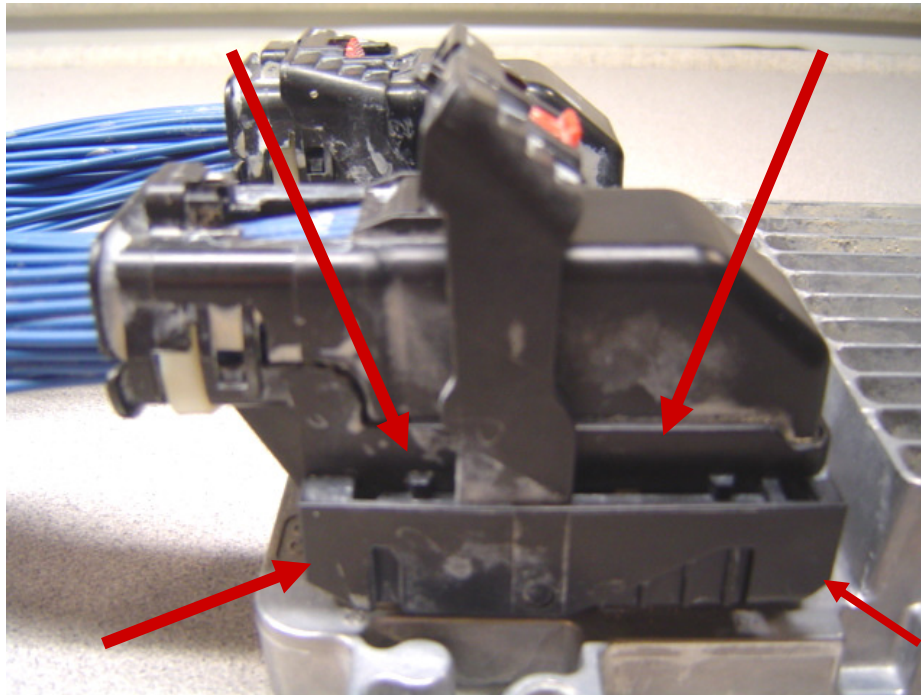

**DO NOT APPLY WATER TO ANY
ECM ASSEMBLY IF
ANY CONNECTORS ARE
UN-MATED FROM THE ECM
HEADERS!**

Water and Air Spray Paths



Section 11 (Appendix B): Cleaning Instructions

STEP 7: Once the connector is removed, inspect for damage and grit. Additional cleaning of the connector housing may be necessary. To avoid dropping grit into terminal openings clean connector with the TPA facing the ground. Using a clean damp (**NOT DRIPPING WET**) paper towel or rag, brush off the heavy deposits. This effort should be directed at the connector housing, not the TPA or terminal openings.

DO NOT APPLY WATER TO TPA OR EXPOSED TERMINAL OPENINGS!

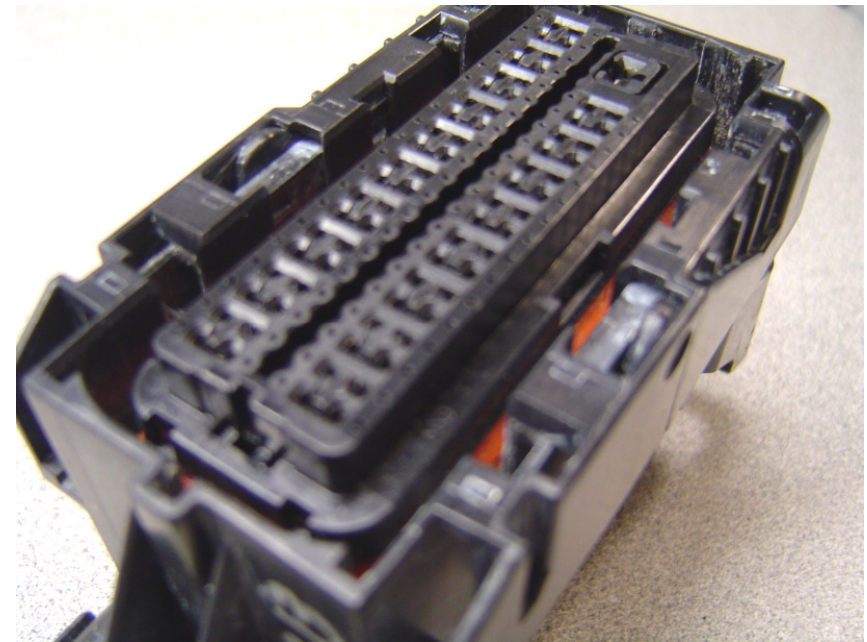
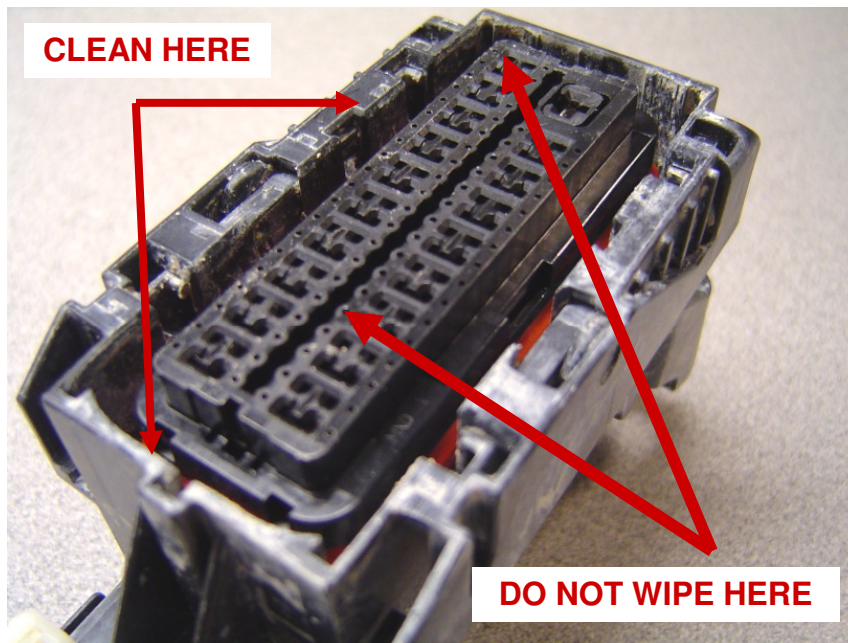

molex® “Gritty” J2 Connector

“Cleaned” J2 Connector

Section 11 (Appendix B): Cleaning Instructions

STEP 8: After connector removal, additional cleaning of the ECM header may be necessary. The amount of dirt pictured on the left below is unacceptable. Using a damp (**NOT DRIPPING WET**) clean paper towel or rag, brush off the heavy deposits. This effort should be directed at the outside of the ECM header, not the internal area where the terminal pins are.

STEP 9: Blow off with high pressure air to dry and remove any grit particles inside the header.



“Gritty” ECM Header

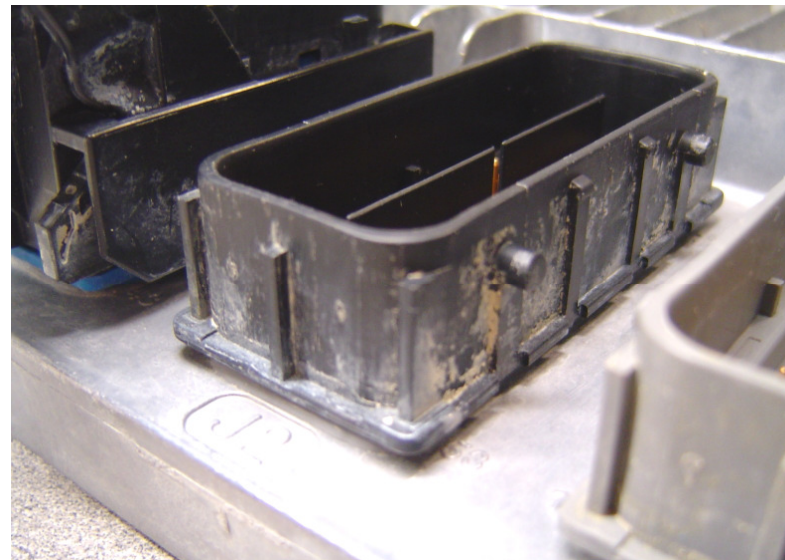

“Cleaned” ECM Header

**DO NOT
APPLY
WATER TO
HEADER
PINS OR
EXPOSED
CONTACT
AREAS**



Section 11 (Appendix B): Cleaning Instructions

STEP 10: Once the connector is in pre-stage, use a few drops of water to lubricate the slides while re-mating. This will limit any potential binding.

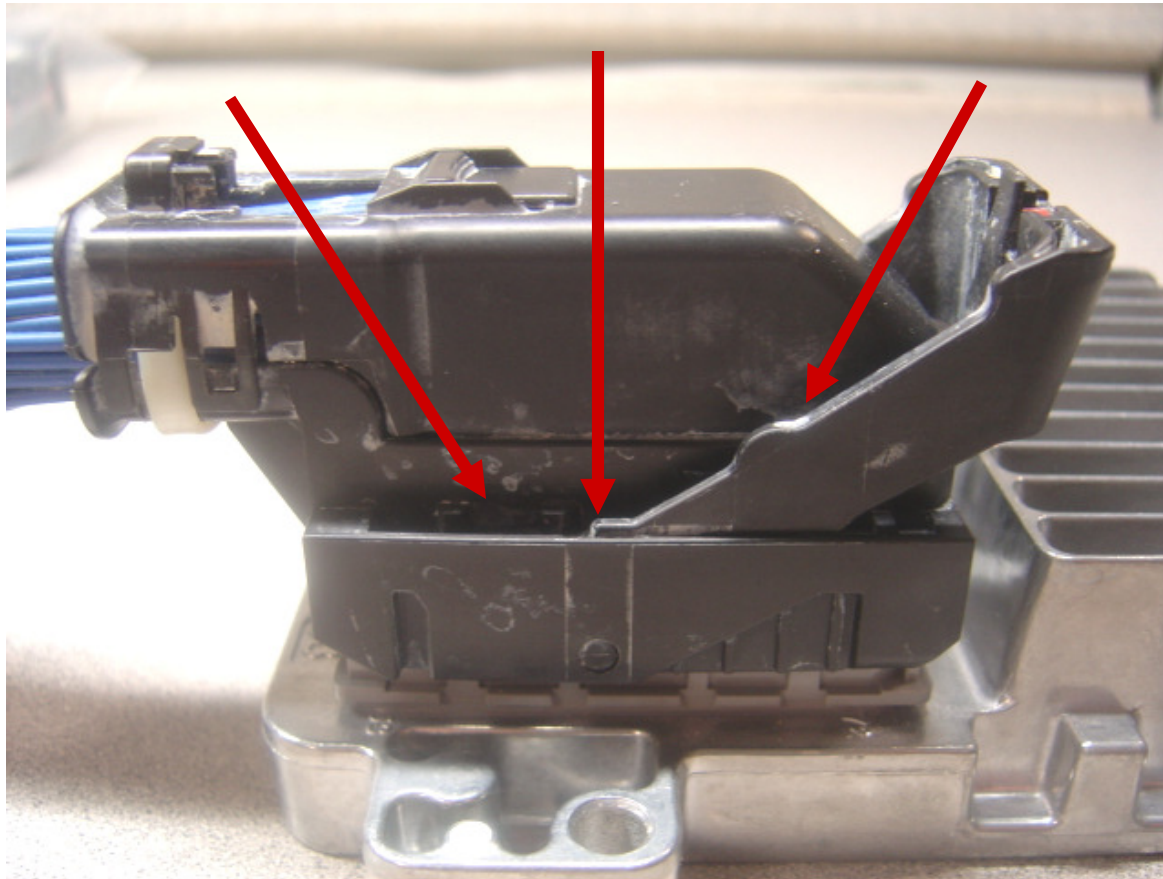

Arrows show where to place drops of water

