

Assembly Instructions for - 37208

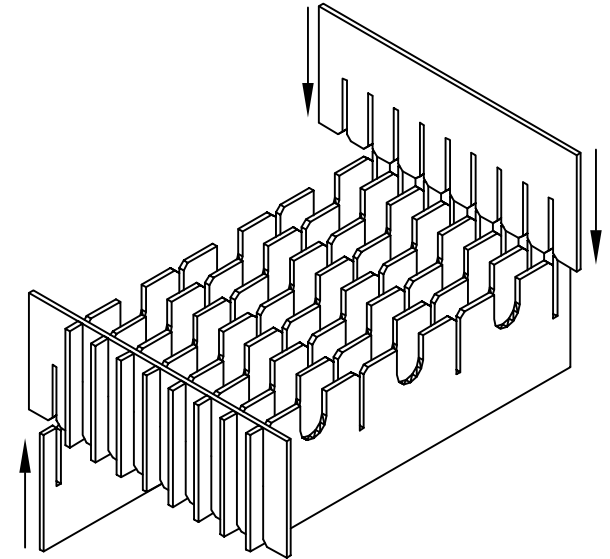
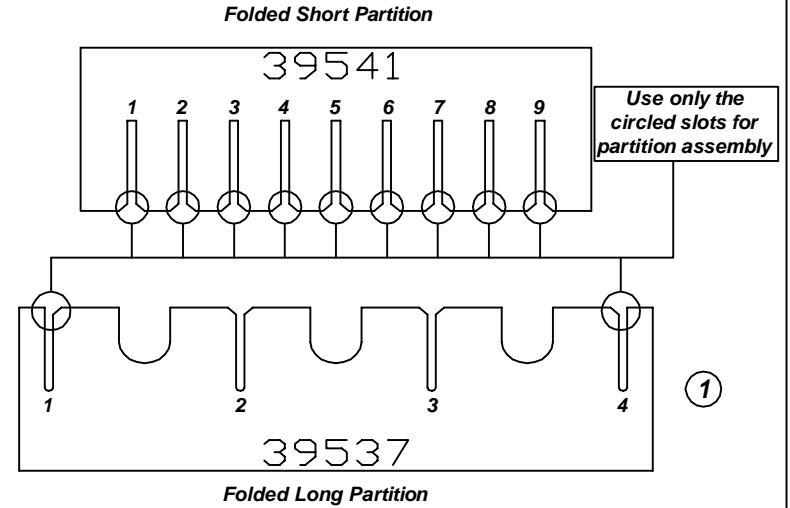
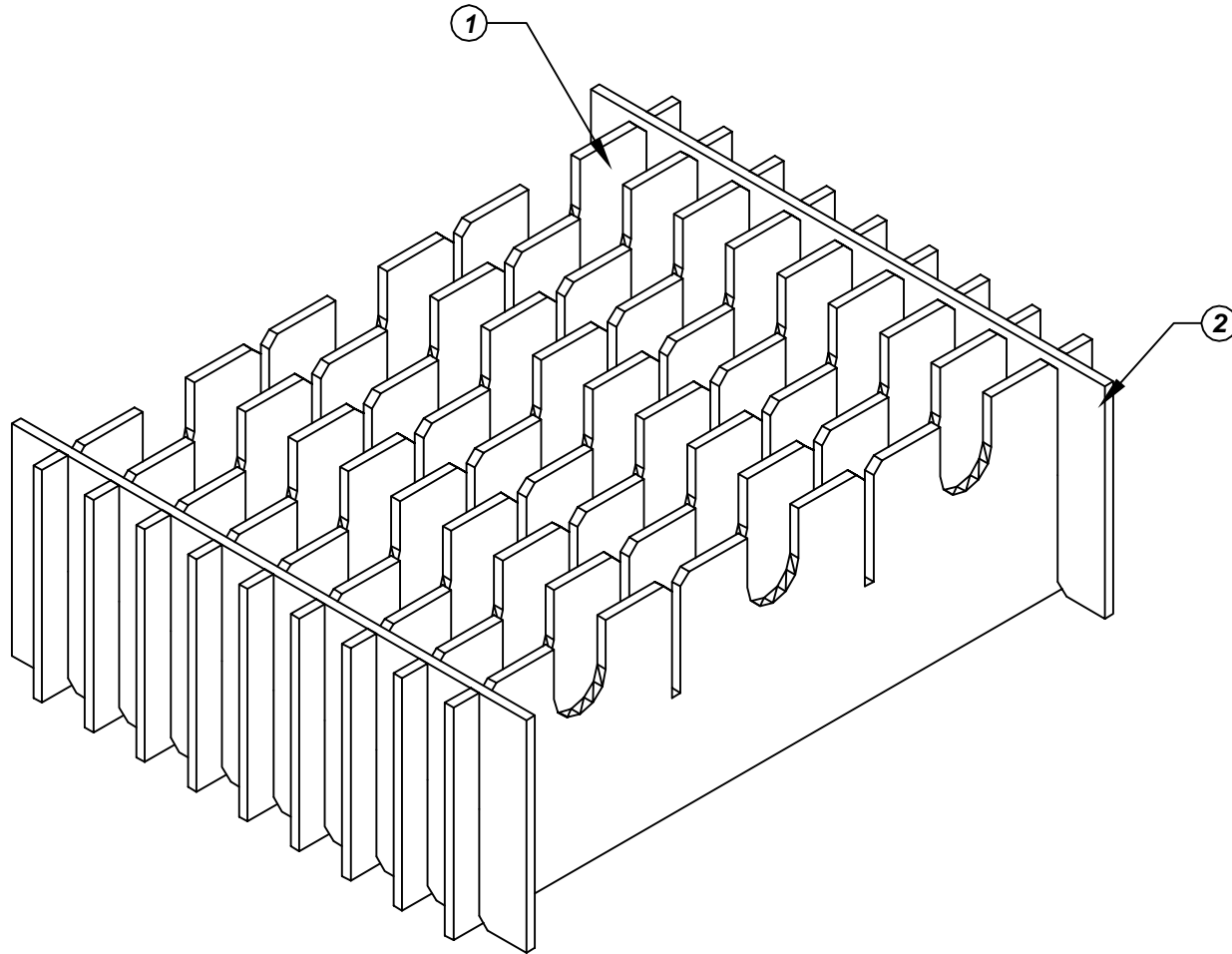

Made in America

F/N ①	Part # 39537	Dimensions: 12" x 18-5/8"	Description: 406/468-LP-10/30 Long Partition	Qty: 9
F/N ②	Part # 39541	Dimensions: 12" x 15"	Description: 406-SP-10	Qty: 2

37208 - 10 Cell Inplant Handler Cell Size - 5-7/8" x 16-5/8" x 1-1/4"

Notes:
For use with the following storage container & lid:
37506 - Storage Container
37554 - Lid

PROTEKTIVE PAK
13520 MONTE VISTA AVENUE, CHINO, CA 91710
PHONE (909) 627-2578, FAX (909) 363-7331
ProtektivePak.com



DRAWING NUMBER
IPH-37208

DATE
Nov.
2007