

THIS DOCUMENT IS THE PROPERTY OF
KEYSTONE ELECTRONICS CORP. AND
SHALL NOT BE REPRODUCED, DISTRIBUTED
OR USED AS A BASIS FOR MANUFACTURE
WITHOUT PRIOR WRITTEN PERMISSION
FROM KEYSTONE ELECTRONICS CORP.

ACTUAL SIZE

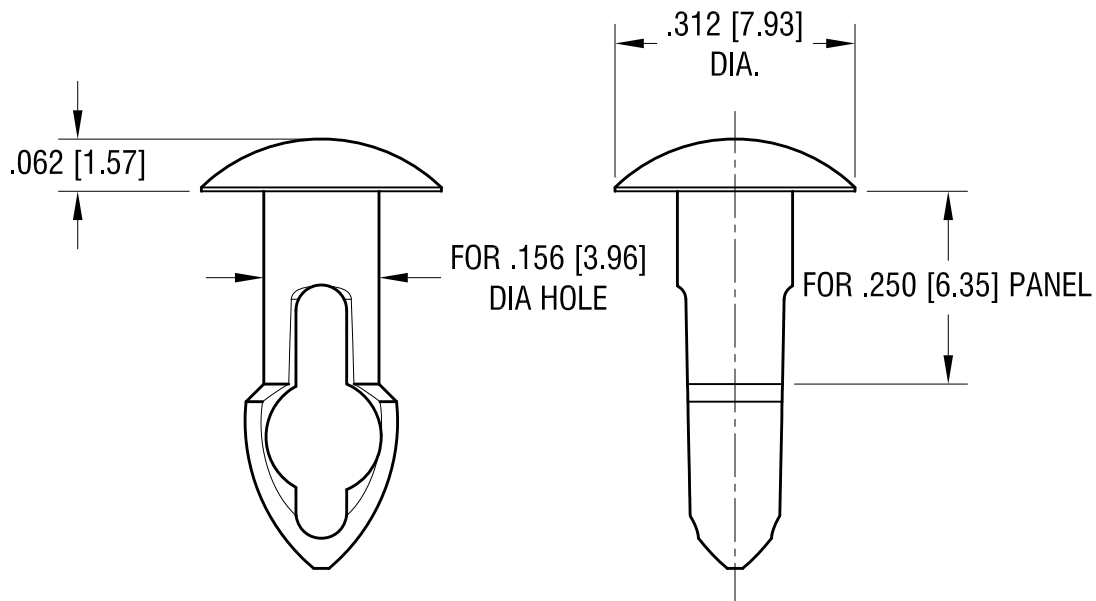

KEYSTONE ELECTRONICS CORP.

www.keyelco.com • ASTORIA, N.Y. 11105-2017 • Tel (718) 956-8900

PART NAME		KEY HOLE CLIP	
MATERIAL		NYLON UL-94V2 - BLACK	
FINISH	-	DRN BY	NT
		APP'D	LN
		DATE	10.07.13
		SCALE	4X
TOLERANCES	INCH [MM]	CODE	DWG NO.
DECIMAL	± .015 [± 0.38]	C	3315
ANGULAR	± 1°		
UNLESS OTHERWISE SPECIFIED			

DATE	DESCRIPTION	REV.