

ACPL-227 / ACPL-247

DC Input Multi-Channel Half-Pitch Phototransistor Optocoupler



Data Sheet



Description

The ACPL-227 is a DC-input dual channel half-pitch phototransistor optocoupler which contains two light emitting diodes optically coupled to two separate phototransistors. It is packaged in an 8-pin SO package.

Likewise, the ACPL-247 is a DC-input quad channel half-pitch phototransistor optocoupler which contains four light emitting diodes optically coupled to four separate phototransistors. It is packaged in a 16-pin SO package.

For both devices, the input-output isolation voltage is rated at 3,000 Vrms. Response time, t_r , is 2 μ s typically, while minimum CTR is 50% at input current of 5 mA.

ACPL-227 pin layout ACPL-247 pin layout

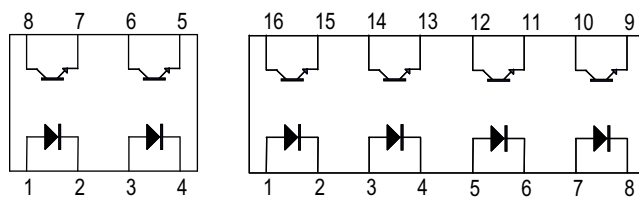

Pin 1, 3	Anode	Pin 1, 3, 5, 7	Anode
Pin 2, 4	Cathode	Pin 2, 4, 6, 8	Cathode
Pin 5, 7	Emitter	Pin 9,11,13,15	Emitter
Pin 6, 8	Collector	Pin 10,12,14,16	Collector

Features

- Current transfer ratio (CTR: 50% (min) at $I_F = 5\text{mA}$, $V_{CE} = 5\text{V}$)
- High input-output isolation voltage ($V_{ISO} = 3,000V_{RMS}$)
- Non-saturated Response time (t_r : 2 μ s (typ) at $V_{CC} = 10\text{V}$, $I_C = 2\text{mA}$, $R_L = 100\Omega$)
- SO package
- CMR 10kV/ μ s (typical)
- Safety and regulatory approvals
 - cUL
 - IEC/EN/DIN EN 60747-5-2
- Options available:
 - CTR Ranks 0, B & C for ACPL-227 and Rank 0 only for ACPL-247

Applications

- I/O Interface for Programmable controllers, computers.
- Sequence controllers
- System appliances, measuring instruments
- Signal transmission between circuits of different potentials and impedances.

Ordering Information

ACPL-2x7-xxxx is UL recognized at 3,000 Vrms for 1 minute per UL1577 and Canadian Component Acceptance Notice #5.

Part number	RoHS Compliant Option				Package	No. Of Channels	Surface Mount	Tape & Reel	IEC/EN/DIN EN 60747-5-2	Quantity
	Rank '0' 50% <CTR< 600%	Rank '0' 100% <CTR< 600%	Rank 'B' 130% <CTR< 260%	Rank 'C' 200% <CTR< 400%						
ACPL-227	I _F =5mA V _{CE} =5V	I _F =5mA V _{CE} =5V	I _F =5mA V _{CE} =5V	I _F =5mA V _{CE} =5V	SO-8	Dual	X	X		2000 pcs per reel
					SO-8	Dual	X	X	X	2000 pcs per reel
ACPL-247		-500E			SO-16	Quad	X	X		2000 pcs per reel
		-560E			SO-16	Quad	X	X	X	2000 pcs per reel

To order, choose a part number from the part number column and combine with the desired option from the option column to form an order entry.

Example 1:

ACPL-227-56CE to order product of Dual Channel SO-8 Surface Mount package in Tape & Reel with IEC/EN/DIN EN 60747-5-2 Safety Approval, 200%<CTR<400% and RoHS compliant.

Example 2:

ACPL-247-500E to order product of Quad Channel SO-16 Surface Mount package in Tape and Reel packaging with 100%<CTR<600% and RoHS compliant.

Option datasheets are available. Contact your Avago sales representative or authorized distributor for information.

Package Outline Drawings

ACPL-227 PACKAGE OUTLINE

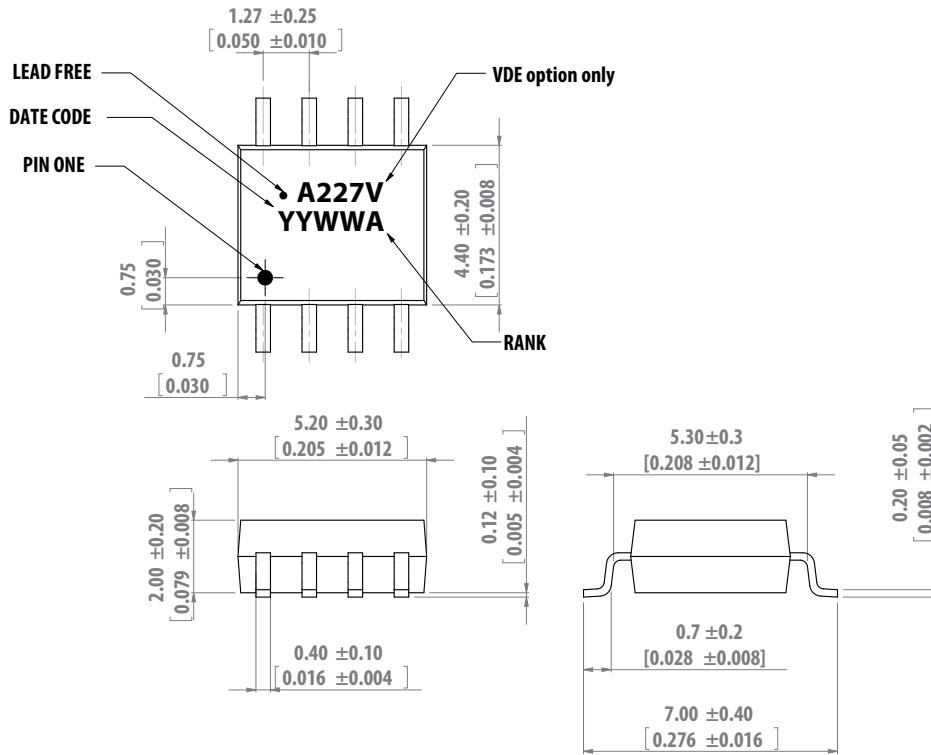

DIMENSIONS IN MILLIMETERS [INCHES]

ACPL-247 PACKAGE OUTLINE

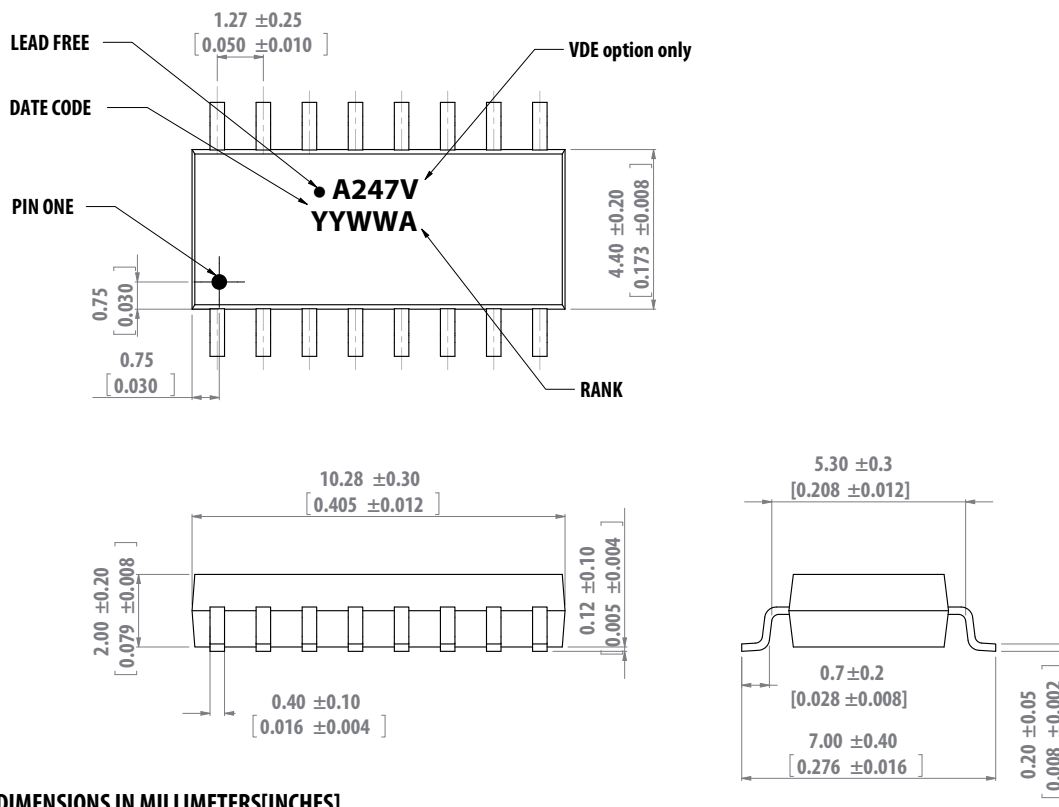

DIMENSIONS IN MILLIMETERS [INCHES]

Solder Reflow Temperature Profile

Recommended reflow condition as per JEDEC Standard, J-STD-020 (latest revision). Non-Halide Flux should be used.

Absolute Maximum Ratings

Parameter	Symbol	ACPL-227	ACPL-247	Units	Note
Storage Temperature	T_S	-55~125		°C	
Operating Temperature	T_A	-55~110		°C	
Average Forward Current	$I_{F(AVG)}$	50		mA	
Pulse Forward Current	I_{FSM}	1		A	
Reverse Voltage	V_R	6		V	
LED Power Dissipation (1 channel)	P_I	65		mW	
Collector Current	I_C	50		mA	
Collector-Emitter Voltage	V_{CEO}	80		V	
Emitter-Collector Voltage	V_{ECO}	7		V	
Isolation Voltage (AC for 1 min, R.H. 40~60%)	V_{ISO}	3,000		V_{RMS}	1min
Collector Power Dissipation (1 channel)	P_C	150	100	mW	
Total Power Dissipation	P_{TOT}	200	170	mW	
Lead Solder Temperature		260°C for 10 seconds			

Electrical Specifications (DC)

Over recommended ambient temperature at 25°C unless otherwise specified.

Parameter	Symbol	Min.	Typ.	Max.	Units	Test Conditions	Note
Forward Voltage	V_F	-	1.2	1.4	V	$I_F = 20\text{mA}$	Fig.6
Reverse Current	I_R	-	-	10	μA	$V_R = 5\text{V}$	
Terminal Capacitance	C_t	-	30	-	pF	$V = 0, f = 1\text{MHz}$	
Collector Dark Current	I_{CEO}	-	-	100	nA	$V_{CE} = 48\text{V}, I_F = 0\text{mA}$	Fig.12
Collector-Emitter Breakdown Voltage	BV_{CEO}	80	-	-	V	$I_C = 0.5\text{mA}, I_F = 0\text{mA}$	
Emitter-Collector Breakdown Voltage	BV_{ECO}	7	-	-	V	$I_E = 100\mu\text{A}, I_F = 0\text{mA}$	
Current Transfer Ratio (ACPL-227 Only)	CTR	50	-	600	%	$I_F = 5\text{mA}, V_{CE} = 5\text{V}$	$CTR = (I_C/I_F) * 100\%$
Current Transfer Ratio (ACPL-247 Only)	CTR	100	-	600	%	$I_F = 5\text{mA}, V_{CE} = 5\text{V}$	$CTR = (I_C/I_F) * 100\%$
Saturated CTR	CTR(sat)	-	60	-	%	$I_F = 1\text{mA}, V_{CE} = 0.4\text{V}$	
Collector-Emitter Saturation Voltage	$V_{CE(sat)}$	-	-	0.4	V	$I_F = 8\text{mA}, I_C = 2.4\text{mA}$	Fig.14
Isolation Resistance	R_{iso}	5×10^{10}	1×10^{11}	-	Ω	DC500V, R.H. 40~60%	
Floating Capacitance	C_F	-	0.6	1	pF	$V = 0, f = 1\text{MHz}$	
Cut-off Frequency (-3dB)	F_C	-	80	-	kHz	$V_{CC} = 5\text{V}, I_C = 2\text{mA}, R_L = 100\Omega$	Fig. 2,19
Response Time (Rise)	t_r	-	2	-	μs	$V_{CC} = 10\text{V}, I_C = 2\text{mA}, R_L = 100\Omega$	Fig. 1
Response Time (Fall)	t_f	-	3	-	μs		
Turn-on Time	t_{on}	-	3	-	μs		
Turn-off Time	t_{off}	-	3	-	μs		
Turn-ON Time	t_{ON}	-	2	-	μs	$V_{CC} = 5\text{V}, I_F = 16\text{mA}, R_L = 1.9\text{k}\Omega$	Fig. 1, 17
Storage Time	T_S	-	25	-	μs		
Turn-OFF Time	t_{OFF}	-	40	-	μs		
Common Mode Rejection Voltage	CMR	-	10	-	kV/ μs	$T_a = 25^\circ\text{C}, R_L = 470\Omega, V_{CM} = 1.5\text{kV(peak)}, I_F = 0\text{mA}, V_{CC} = 9\text{V}, V_{np} = 100\text{mV}$	Fig.20

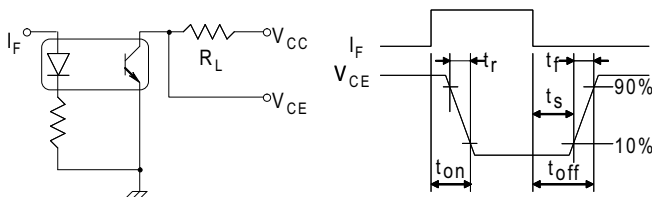

Figure 1. Switching Time Test Circuit

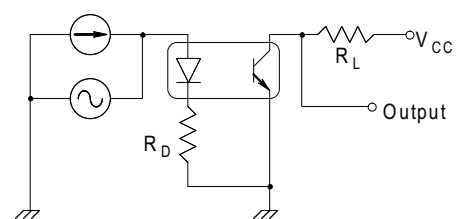

Figure 2. Frequency Response Test Circuit

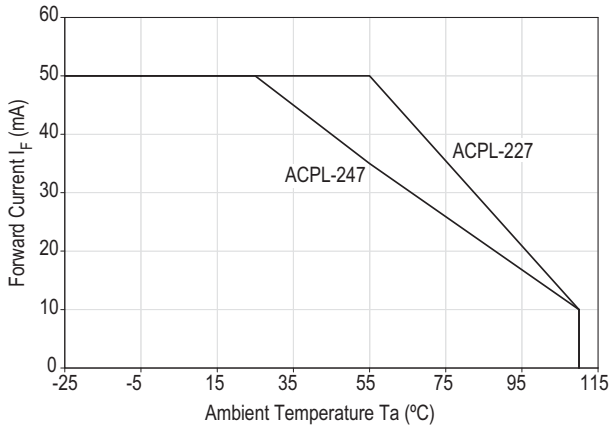

Figure 3. Forward Current vs. Ambient Temperature.

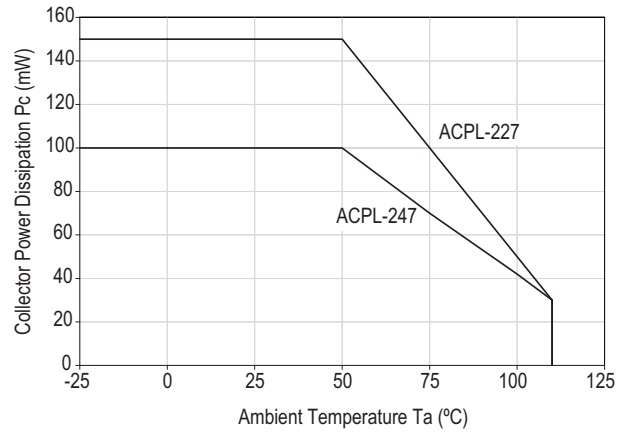

Figure 4. Collector Power Dissipation vs. Ambient Temperature

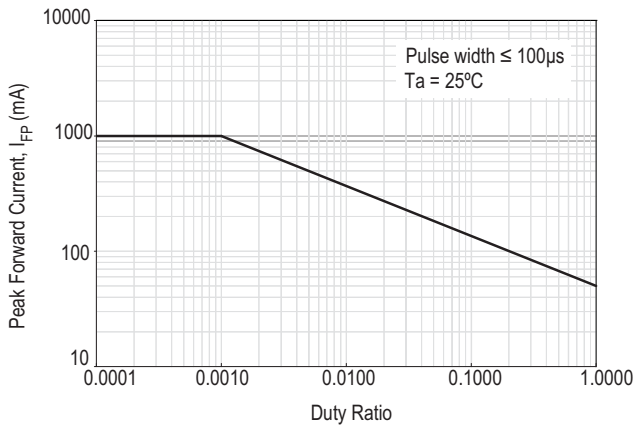

Figure 5. Pulse Forward Current vs. Duty Cycle Ratio

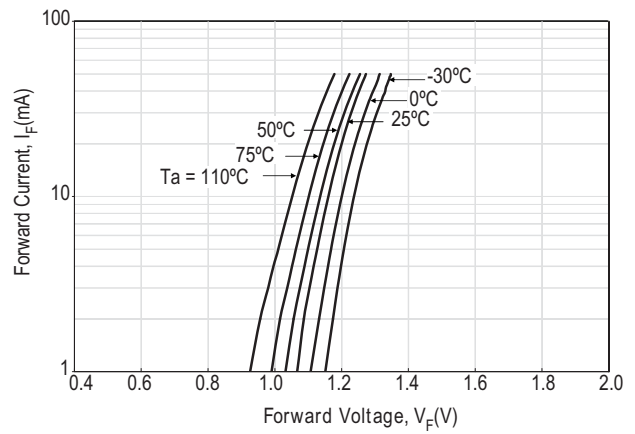

Figure 6. Forward Current vs. Forward Voltage

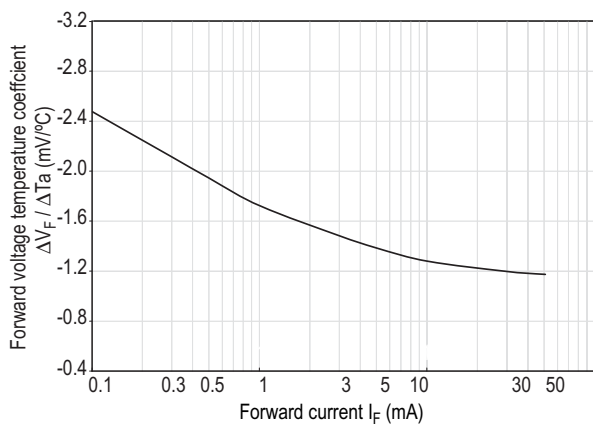

Figure 7. Forward Voltage Temperature Coefficient vs. Forward Current

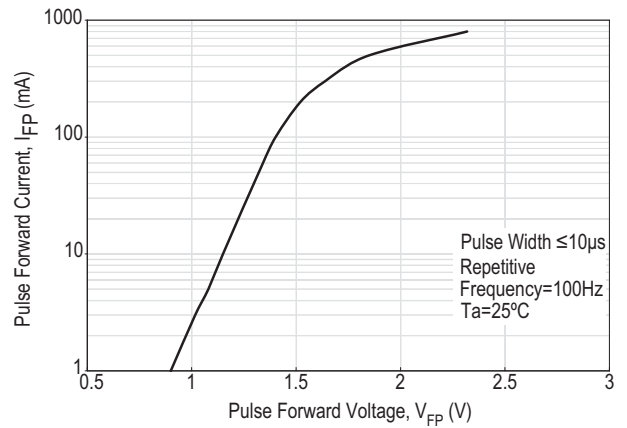

Figure 8. Pulse Forward Current vs. Pulse Forward Voltage

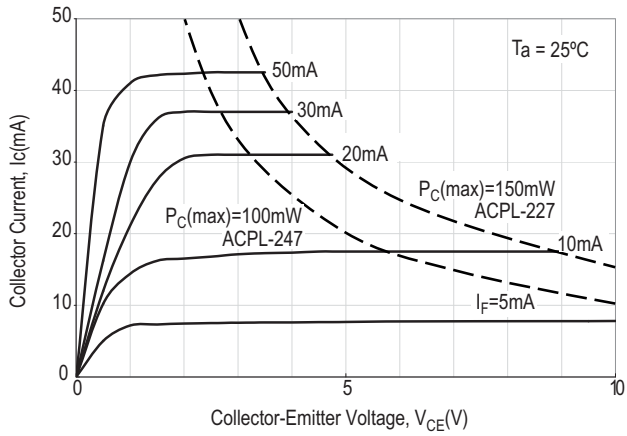

Figure 9. Collector Current vs. Collector-Emitter Voltage

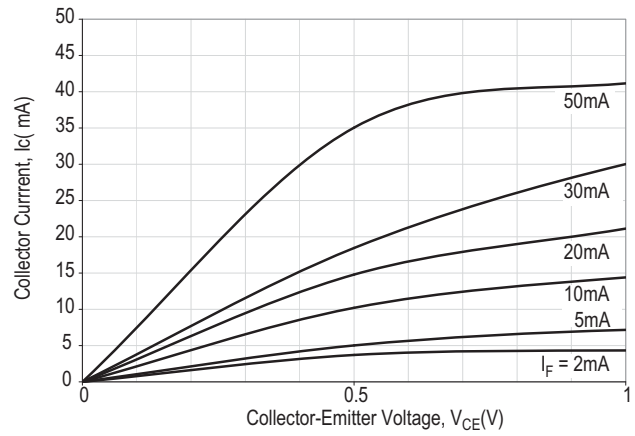

Figure 10. Collector Current vs. Small Collector-Emitter Voltage

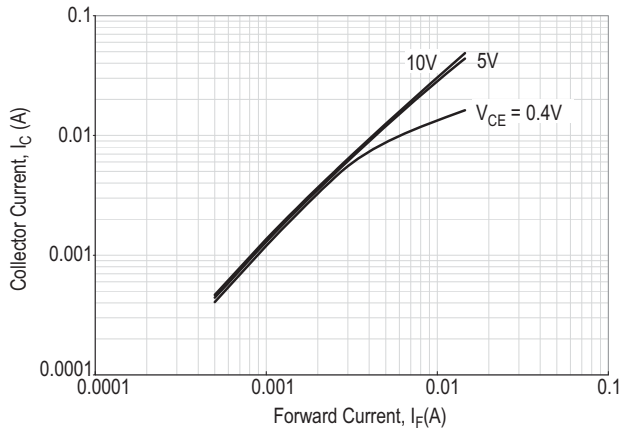

Figure 11. Collector Current vs. Forward Current

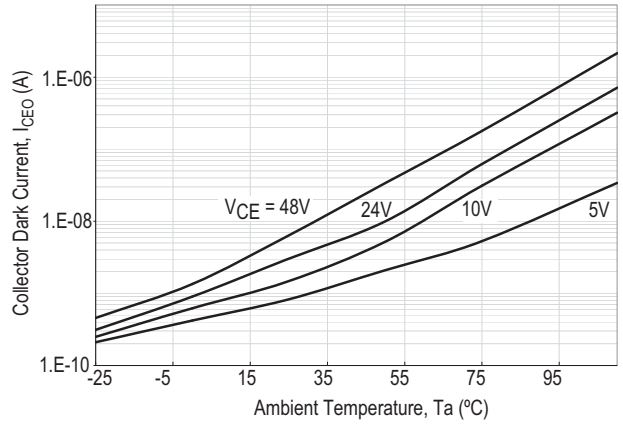

Figure 12. Collector Dark Current vs. Ambient Temperature

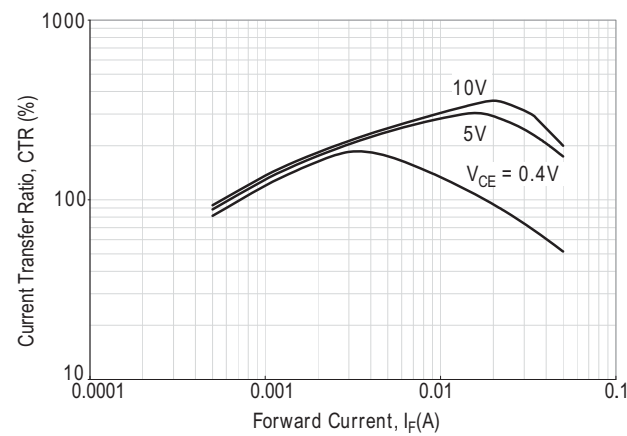

Figure 13. Current Transfer Ratio vs. Forward Current

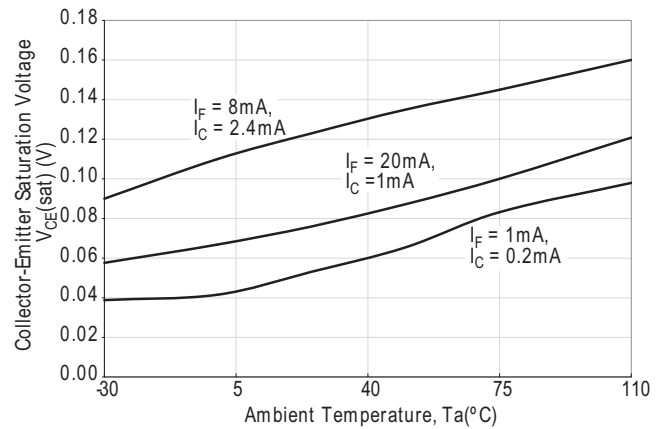

Figure 14. Collector-Emitter Saturation Voltage vs. Ambient Temperature

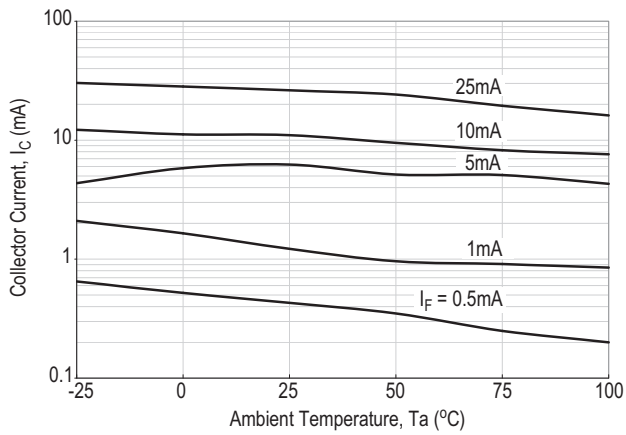

Figure 15. Collector Current vs. Ambient Temperature

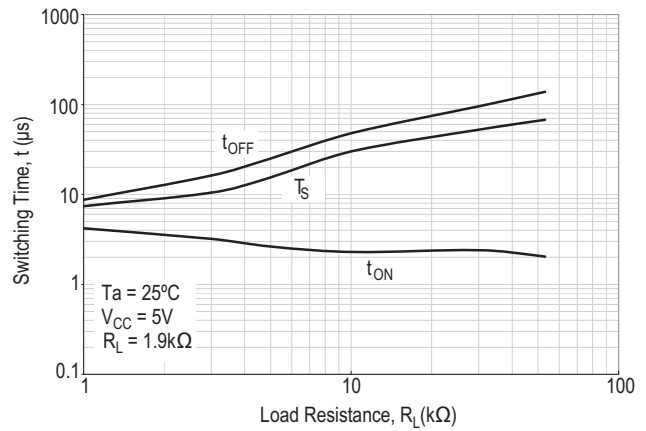

Figure 16. Switching Time vs. Load Resistance

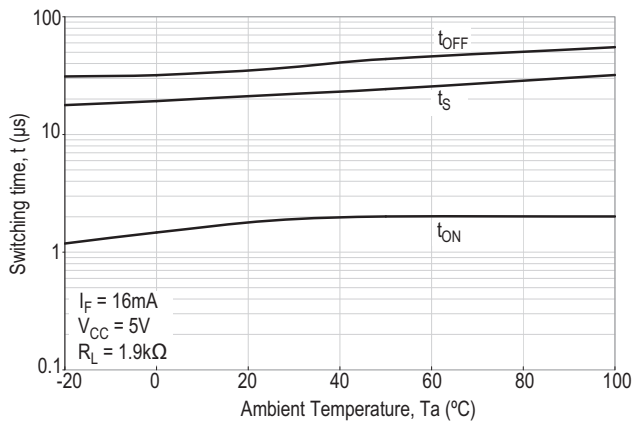

Figure 17. Switching Time vs. Ambient Temperature

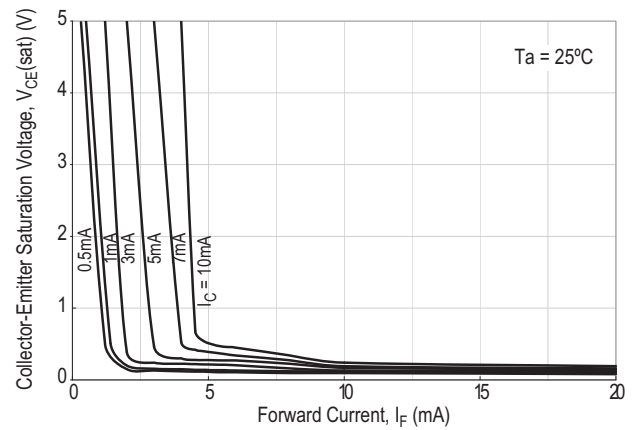

Figure 18. Collector-Emitter Saturation Voltage vs. Forward Current

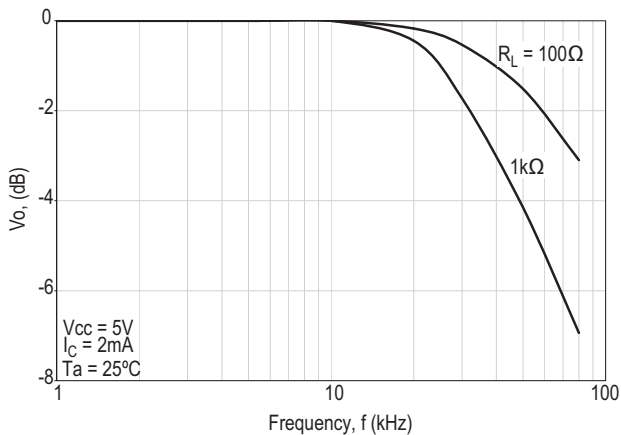

Figure 19. Frequency Response

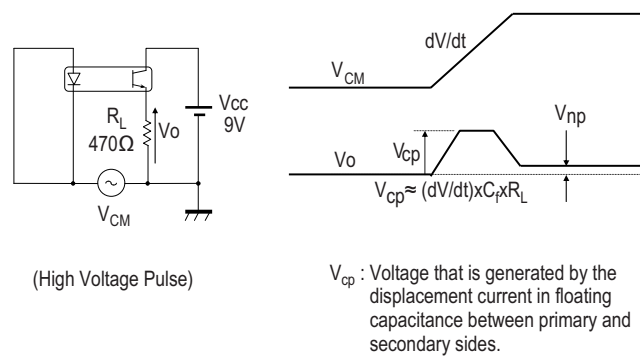

Figure 20. CMR Test Circuit

For product information and a complete list of distributors, please go to our web site: www.avagotech.com

Avago, Avago Technologies, and the A logo are trademarks of Avago Technologies in the United States and other countries. Data subject to change. Copyright © 2005-2010 Avago Technologies. All rights reserved. AV02-0752EN - July 20, 2010

AVAGO
TECHNOLOGIES