

Features

- Compliant with IEEE802.3 standards
- Designed for 10/100/1000 Base-T and PoE
- 5K VAC dielectric withstanding voltage
- RoHS compliant*

Applications

- LAN
- Ethernet
- Power over Ethernet - PoE

SM51589PEL LAN 10/100/1000 Base-T Transformer (PoE) Modules

Electrical Specifications @ 25 °C

Turns Ratio ($\pm 5\%$)1CT:1CT
OCL (@100 kHz, 0.1 V, 8 mA, DC Bias) 350 μ H min.
Leakage Inductance (@100 kHz, 0.1 V) 0.5 μ H max.
Interwinding Capacitance @ 100 kHz, 0.1 V 35 pF max.
Isolation Hi-Pot 5000 VAC, 1 mA, 2 seconds
Insertion Loss 1-100 MHz-1.0 dB max.
Return Loss (@ 100 Ohms) 1-30 MHz-18 dB min.
40 MHz-14.4 dB min.
50 MHz-13.1 dB min.
60-80 MHz-12 dB min.
100 MHz-10 dB min.
Cross Talk 30 MHz-45 dB min.
60 MHz-40 dB min.
80 MHz-35 dB min.
DCMR 30 MHz-43 dB min.
60 MHz-37 dB min.
80 MHz-33 dB min.
PoE CurrentUp to 720 mADC
Operating Temperature Range-40 °C to +85 °C
Storage Temperature Range-25 °C to +125 °C

Packaging Specifications

Tape & Reel 400 pcs./reel

How To Order

Model	SM51589 P E L
Construction	P = Potted
Packaging	E = Tape and Reel (400 pcs./reel)
Termination	L = Tin (RoHS Compliant)

Electrical Schematic

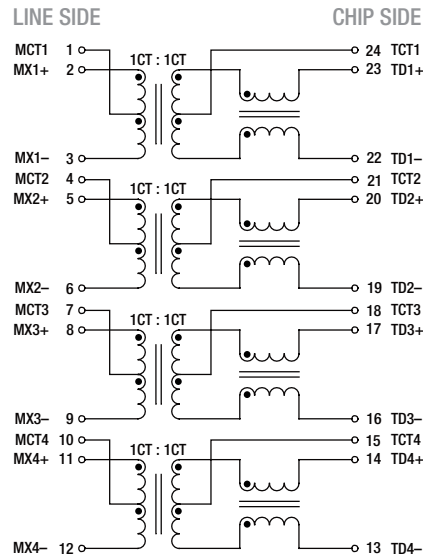

Product Dimensions

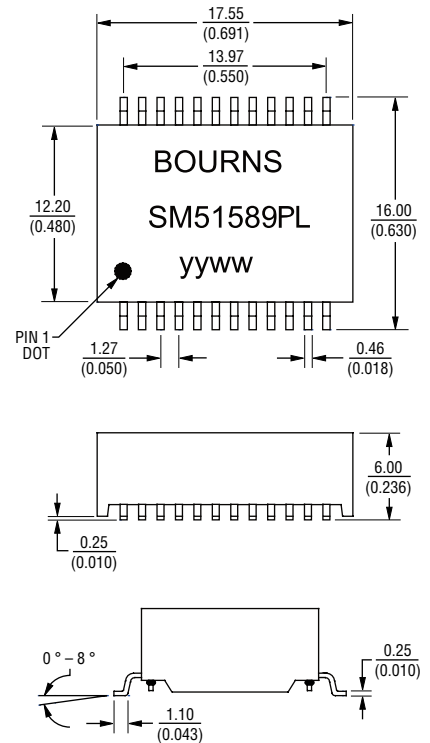

Recommended Layout

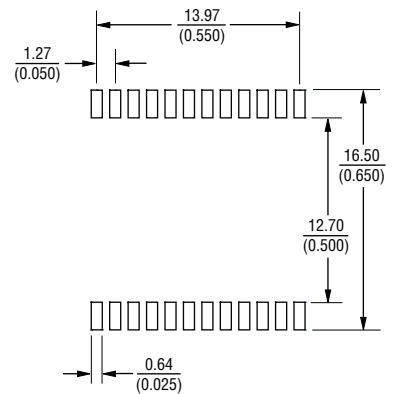

DIMENSIONS: $\frac{\text{MM}}{\text{(INCHES)}}$
 TOLERANCES: xx.xx $\pm \frac{0.25}{(.010)}$
 0.xx $\pm \frac{0.05}{(.002)}$

*RoHS Directive 2002/95/EC Jan. 27, 2003 including annex and RoHS Recast 2011/65/EU June 8, 2011.

Specifications are subject to change without notice.

The device characteristics and parameters in this data sheet can and do vary in different applications and actual device performance may vary over time.

Users should verify actual device performance in their specific applications.

SM51589PEL LAN 10/100/1000 Base-T Transformer (PoE) Modules



Solder Profile

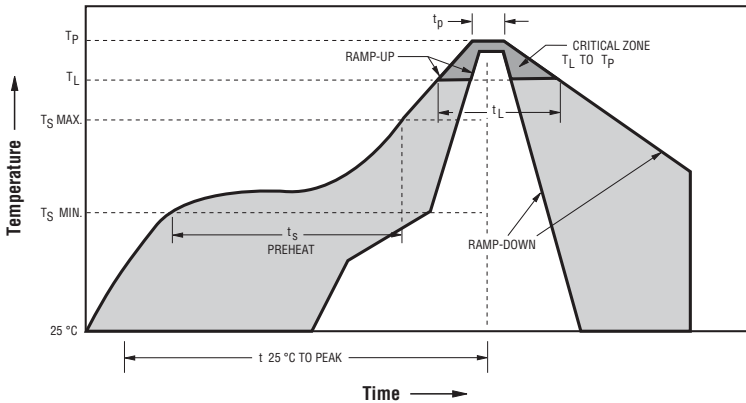

Ramp-up rate = 3 °C/sec. max.
 Ramp-down rate = 6 °C/sec. max.
 $T_L = 217\text{ °C}$ $t_L = 60\text{-}150\text{ sec.}$
 $T_P = 250\text{ °C} \pm 3\text{ °C}$
 Time within 5 °C of actual Peak Temp (t_p) = 20-40 sec.
 $T_S\text{ min} = 150\text{ °C}$ $T_S\text{ max} = 200\text{ °C}$
 $T_S\text{ min to }T_S\text{ max} = 60\text{-}180\text{ sec.}$, 25 °C to Peak Temperature = 8 min. max.

Packaging Specifications

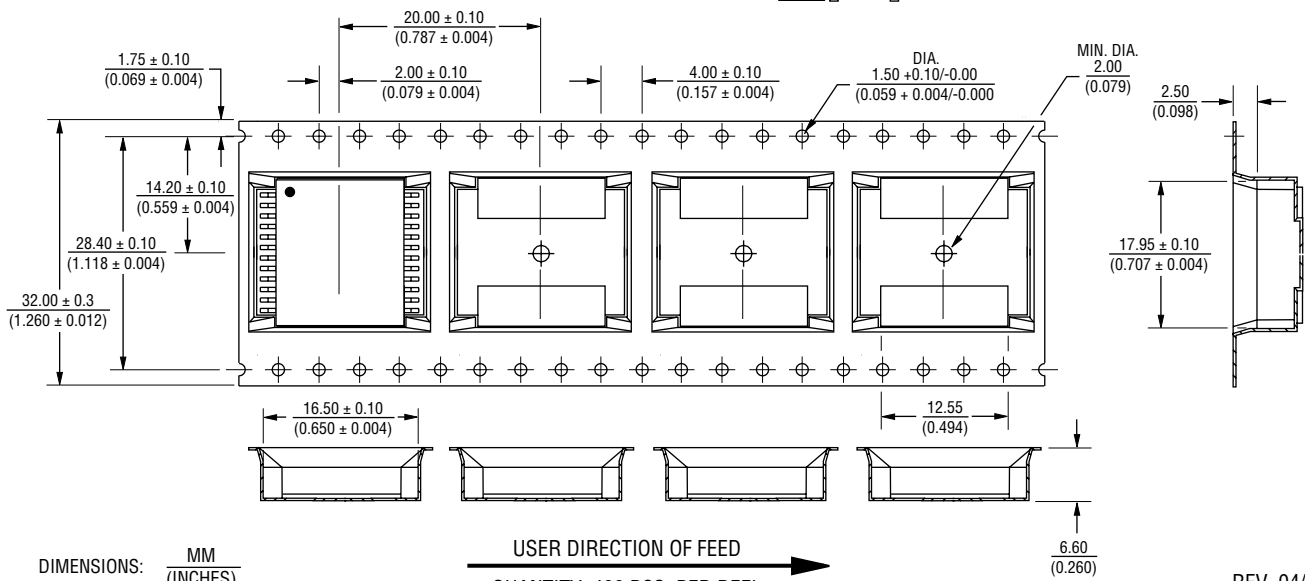
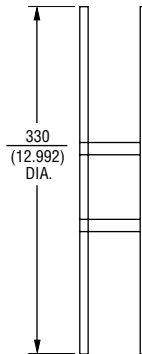
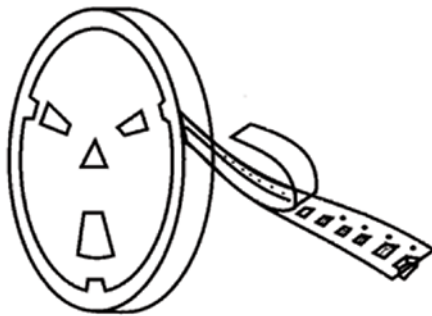

DIMENSIONS: $\frac{\text{MM}}{\text{(INCHES)}}$

USER DIRECTION OF FEED
 QUANTITY: 400 PCS. PER REEL

REV. 04/17

Specifications are subject to change without notice.
 The device characteristics and parameters in this data sheet can and do vary in different applications and actual device performance may vary over time.
 Users should verify actual device performance in their specific applications.