



Muffin XP - MS48B3 - 032527 - No
 (Family) (Model) (Part #) (In Stock)

Electrical Specifications

Operating Voltage:	48 Volts
Voltage Range:	24 - 56 Volts
Power Supply:	7.4 Watts
Line Current:	0.15 Amps
Locked Rotor Current	0.39 Amps
Nominal Speed:	2900 RPM



Mechanical Specifications

Dimensions:	4.7 x 4.7 x 1.5 in
Weight	8.82 oz
Max Airflow @ 0 in H ₂ O	110.0 CFM
Max Pressure @ 0 CFM	0.252 in H ₂ O
Noise	49.5 dBA



Mechanical Drawing

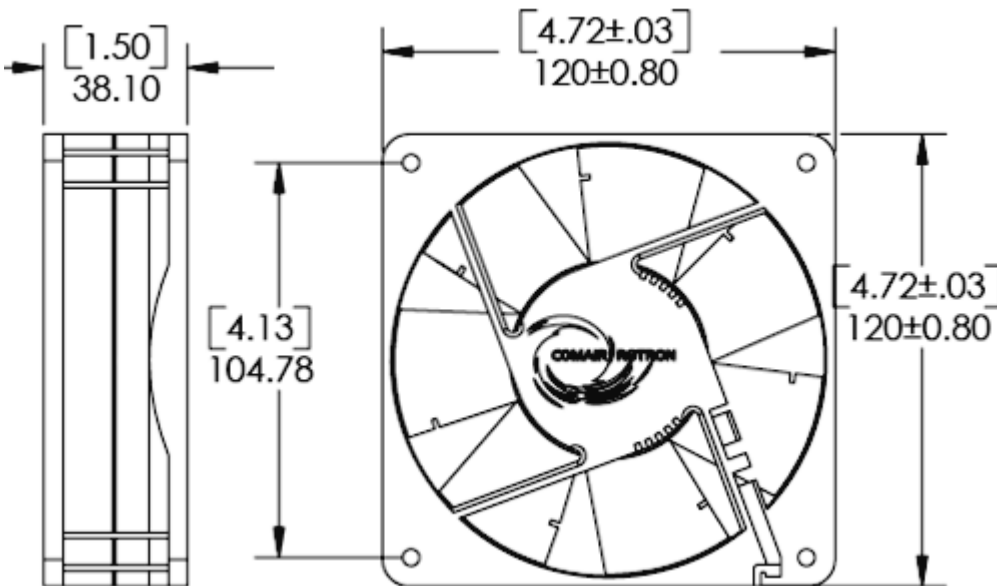

Comair Rotron, Inc.
 Phone: 619.651.2000
 sales@comairrotron.com

Comair Rotron Europe, Ltd.
 Phone: +44.1527.520525
 saleseurope@comairrotron.com

Comair Rotron Fan Company Ltd.
 Phone: +86.21.52260581
 salesasia@comairrotron.com

Print Date: Friday, November 20, 2009 at 12:55:56 - DC Fan Datasheet - Web Version 1.0 Rev. B



Fan Performance Curve

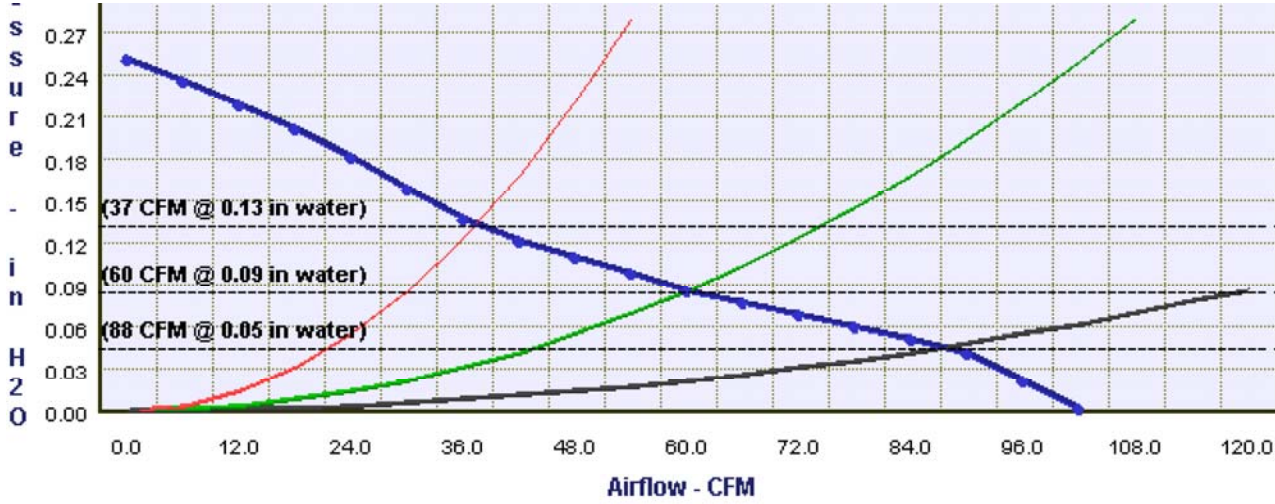

Fan Configuration Options

Muffin XP (Family) **MS48B3** (Model) **/ 032527** (Part #) **No** (In Stock) **305 mm [12 inch] Leads** (Features)

Fan Speed: **2900 RPM** Fan Bearings: **Ball Bearings**
 Fan Airflow Direction: **Flow R (CCW Rotation)** Fan Termination: **Leads**

Fan Monitoring Options: **No Fan Monitoring Options Selected**

Fan Speed Control Option: **No ThermaPro-V Fan Speed Control Options Selected**

Environmental Protection Options: **No Enviroshield Options Selected**

Comair Rotron, Inc.
 Phone: 619.651.2000
 sales@comairrotron.com

Comair Rotron Europe, Ltd.
 Phone: +44.1527.520525
 saleseurope@comairrotron.com

Comair Rotron Fan Company Ltd.
 Phone: +86.21.52260581
 salesasia@comairrotron.com

Print Date: Friday, November 20, 2009 at 12:55:56 - DC Fan Datasheet - Web Version 1.0 Rev. B



Accessories (Click on part number for detailed drawing.)

- 571064
Plug and Cord



- 550113
Mounting Clip

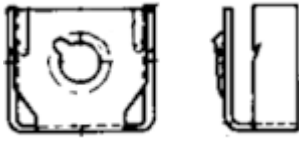

- 551590
Filter Assembly

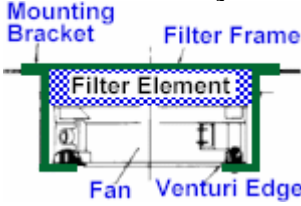

- 554148
Filter Guard Assembly

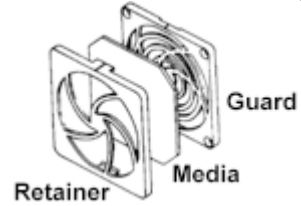

- 552934
Finger Guard



- 476042
Finger Guard

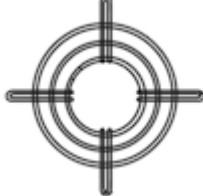

- 550481
Finger Guard

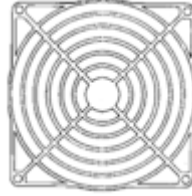

- 551147
Finger Guard

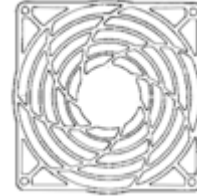

Comair Rotron, Inc.
Phone: 619.651.2000
sales@comairrotron.com

Comair Rotron Europe, Ltd.
Phone: +44.1527.520525
saleseurope@comairrotron.com

Comair Rotron Fan Company Ltd.
Phone: +86.21.52260581
salesasia@comairrotron.com

Print Date: Friday, November 20, 2009 at 12:55:56 - DC Fan Datasheet - Web Version 1.0 Rev. B