

# AMPROBE®

HARD AT WORK SINCE 1948.

## DM-5 Power Quality Analyzer Manual





**AMPROBE®**

# **DM-5 Power Quality Analyzer**

## **Instruction Manual**

**English**

## **Limited Warranty and Limitation of Liability**

Your Amprobe product will be free from defects in material and workmanship for 1 year from the date of purchase. This warranty does not cover fuses, disposable batteries or damage from accident, neglect, misuse, alteration, contamination, or abnormal conditions of operation or handling. Resellers are not authorized to extend any other warranty on Amprobe's behalf. To obtain service during the warranty period, return the product with proof of purchase to an authorized Amprobe Test Tools Service Center or to an Amprobe dealer or distributor. See Repair Section for details. THIS WARRANTY IS YOUR ONLY REMEDY. ALL OTHER WARRANTIES - WHETHER EXPRESS, IMPLIED OR STATUTORY - INCLUDING IMPLIED WARRANTIES OF FITNESS FOR A PARTICULAR PURPOSE OR MERCHANTABILITY, ARE HEREBY DISCLAIMED. MANUFACTURER SHALL NOT BE LIABLE FOR ANY SPECIAL, INDIRECT, INCIDENTAL OR CONSEQUENTIAL DAMAGES OR LOSSES, ARISING FROM ANY CAUSE OR THEORY. Since some states or countries do not allow the exclusion or limitation of an implied warranty or of incidental or consequential damages, this limitation of liability may not apply to you.

## **Repair**

All Amprobe tools returned for warranty or non-warranty repair or for calibration should be accompanied by the following: your name, company's name, address, telephone number, and proof of purchase. Additionally, please include a brief description of the problem or the service requested and include the test leads with the meter. Non-warranty repair or replacement charges should be remitted in the form of a check, a money order, credit card with expiration date, or a purchase order made payable to Amprobe.

## **In-warranty Repairs and Replacement – All Countries**

Please read the warranty statement and check your battery before requesting repair. During the warranty period, any defective test tool can be returned to your Amprobe distributor for an exchange for the same or like product. Please check the "Where to Buy" section on [www.Amprobe.com](http://www.Amprobe.com) for a list of distributors near you. Additionally, in the United States and Canada, in-warranty repair and replacement units can also be sent to an Amprobe Service Center (see address below).

## **Non-warranty Repairs and Replacement – United States and Canada**

Non-warranty repairs in the United States and Canada should be sent to an Amprobe Service Center. Call Amprobe or inquire at your point of purchase for current repair and replacement rates.

USA:  
Amprobe  
Everett, WA 98203  
Tel: 888-993-5853  
Fax: 425-446-6390

Canada:  
Amprobe  
Mississauga, ON L4Z 1X9  
Tel: 905-890-7600  
Fax: 905-890-6866

## **Non-warranty Repairs and Replacement – Europe**

European non-warranty units can be replaced by your Amprobe distributor for a nominal charge. Please check the "Where to Buy" section on [www.Amprobe.eu](http://www.Amprobe.eu) for a list of distributors near you.

Amprobe Europe\*  
Beha-Amprobe  
In den Engematten 14  
79286 Glottertal, Germany  
Tel.: +49 (0) 7684 8009 - 0  
[www.Amprobe.eu](http://www.Amprobe.eu)

\*(Correspondence only – no repair or replacement available from this address. European customers please contact your distributor.)



## CONTENTS

<b>SAFETY WARNINGS</b> .....	<b>4</b>
<b>UNPACKING AND INSPECTION</b> .....	<b>8</b>
<b>1 INSTRUMENT OVERVIEW</b> .....	<b>9</b>
1.1 Functional overview .....	9
1.2 Features.....	12
1.3 Constructional drawing .....	14
1.4 Steps for measurement .....	15
<b>2 INSTRUMENT LAYOUT</b> .....	<b>16</b>
2.1 Display (LCD)/ Keys .....	16
2.2 Connector .....	17
2.3 Side face.....	18
2.4 Voltage test lead and clamp sensor .....	19
<b>3 BASIC OPERATIONS</b> .....	<b>20</b>
3.1 Key Operation .....	20
3.2 Icons On The Lcd.....	21
3.3 Symbols On The Lcd .....	22
3.4 Backlight And Contrast Adjustment .....	22
3.5 Screens .....	23
Inst/ Integration/ Demand.....	23
Vector .....	24
Waveform .....	25
Harmonic Analysis .....	26
Power Quality .....	27
Settings .....	27
<b>4 GETTING STARTED</b> .....	<b>28</b>
4.1 Power Supply .....	28
Battery.....	28
Battery symbol on the LCD/ Battery level .....	29
How to install batteries.....	30
Power cord connection .....	30
Power supply rating .....	31
4.2 Placing / removing SD card .....	32
Inserting SD card .....	32
Removing SD card .....	32
4.3 Voltage test leads and clamp sensor connection .....	33
4.4 Start DM-5.....	34
Start-up screen.....	34
Cautionary message .....	34

4.5 Recording procedures .....	35
Start of recording .....	35
End of recording.....	35
Start measurement with "Quick Start Guide" .....	36
<b>5 SETTINGS .....</b>	<b>44</b>
5.1 List of setting items .....	44
5.2 Basic setting .....	44
Settings of wiring system .....	45
Wiring connection .....	46
Settings of voltage measurement .....	48
VT/CT .....	49
Settings of current measurement.....	50
Settings of external input terminal/ reference frequency .....	52
5.3 Measurement setting .....	53
Settings of demand measurement .....	53
Outline of demand measurement concept.....	55
Settings for harmonic analysis.....	56
Threshold setting for power quality (Event) .....	57
Filter setting for flicker measurement .....	61
Target power factor for capacitance calculation.....	62
5.4 Recording setting .....	62
Settings for recording items .....	63
Saved items .....	64
Recording method.....	65
Possible recording time.....	66
5.5 Other settings .....	67
Settings for system environment.....	67
DM-5 Setting.....	68
5.6 Saved data .....	71
Delete, transfer or format the recorded data .....	71
Type of the saved data .....	72
DM-5 settings and Data loading .....	78
<b>6 DISPLAYED ITEMS .....</b>	<b>81</b>
6.1 Instantaneous value "W" .....	81
List display of the measured values.....	81
Zoom display.....	84
Displaying trend graph .....	85
Changing displayed items and display position .....	86
6.2 Integration value "Wh" .....	87

6.3 Demand.....	88
Showing the measured values.....	88
Shifts in specific period .....	89
Demand change .....	90
6.4 Vector.....	91
6.5 Waveform .....	93
6.6 Harmonics .....	94
Displaying harmonics on the bar graph.....	95
Displaying the list of harmonics .....	96
6.7 Power quality.....	99
Factors impair power quality and symptoms.....	99
Displaying recorded events.....	101
Displaying measured flicker values in list form .....	104
Displaying trend graph of Pst, 1min .....	105
Displaying changes of Plt.....	106
<b>7 OTHER FUNCTIONS .....</b>	<b>107</b>
<b>8 DEVICE CONNECTION.....</b>	<b>109</b>
8.1 Data transfer to PC.....	109
8.2 Using wireless function .....	109
8.3 Signal control.....	110
Connection to input/ output terminals.....	110
8.4 Getting power from measured lines .....	112
<b>9 PC SOFTWARE FOR SETTING AND DATA ANALYSIS .....</b>	<b>113</b>
<b>10 SPECIFICATION .....</b>	<b>114</b>
10.1 Safety requirements .....	114
10.2 General specification.....	114
10.3 Measurement specification.....	117
Measured items and the number of analysis points .....	117
Items measured at Instantaneous measurement .....	118
Items to be calculated .....	121
Items measured at integration measurement .....	124
Items measured at demand measurement .....	127
Items measured at harmonics measurement.....	128
Items measured at power quality measurement.....	133
10.4 Specification of clamp sensor .....	136
<b>11 TROUBLESHOOTING.....</b>	<b>138</b>
11.1 General troubleshooting.....	138
11.2 Error messages and actions.....	139

## SAFETY WARNINGS

---

This instrument has been designed, manufactured and tested according to IEC 61010-1: Safety requirements for Electronic Measuring apparatus, and delivered in the best condition after passing quality control tests.

**This instruction manual contains warnings and safety procedures which have to be observed by the user to ensure safe operation of the instrument and to maintain it in safe condition. Therefore, read through these operating instructions before starting to use the instrument.**

### **WARNING**

#### **- About Instruction manual -**

- Read through and understand the instructions contained in this manual before using the instrument.
- Keep the manual at hand to enable quick reference whenever necessary.
- The instrument is to be used only in its intended applications.
- Understand and follow all the safety instructions contained in the manual.
- Read the enclosed Quick Start Guide after reading this instruction manual.
- For all accessories and attachments, refer to the individual instruction manual supplied when applicable.

It is essential that the above instructions are adhered to. Failure to follow the above instructions may cause injury, instrument damage and/or damage to equipment under test. Amprobe assumes no responsibility for damage and injury caused by misuse or not following the instructions in the manual.

The symbol  indicated on the instrument, means that the user must refer to the related parts in the manual for safe operation of the instrument. It is essential to read the instructions wherever the symbol appears in the manual.

 **DANGER** : is reserved for conditions and actions that are likely to cause serious or fatal injury.

 **WARNING** : is reserved for conditions and actions that can cause serious or fatal injury.

 **CAUTION** : is reserved for conditions and actions that can cause injury or instrument damage.

## Measurement Category

To ensure safe operation of measuring instruments, IEC 61010 establishes safety standards for various electrical environments, categorized as O to CAT.IV, and called measurement categories. Higher-numbered categories correspond to electrical environments with greater momentary energy, so a measuring instrument designed for CAT.III environments can endure greater momentary energy than one designed for CAT.II.

**O** : Circuits which are not directly connected to the mains power supply.

**CAT.II** : Electrical circuits of equipment connected to an AC electrical outlet by a power cord.

**CAT.III** : Primary electrical circuits of the equipment connected directly to the distribution panel, and feeders from the distribution panel to outlets.

**CAT.IV** : The circuit from the service drop to the service entrance, and to the power meter and primary overcurrent protection device (distribution panel).

# SAFETY WARNINGS

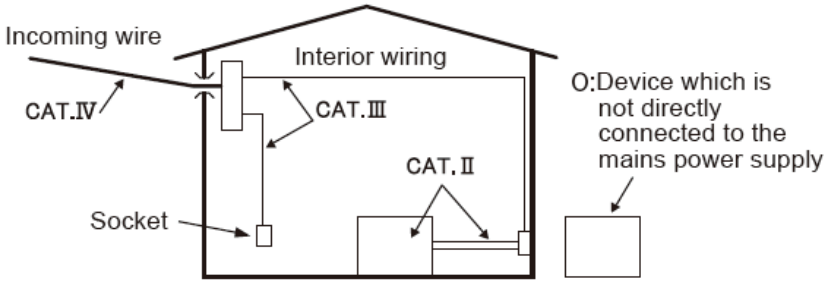

## **⚠️⚠️ DANGER**

- The instrument is to be used only in its intended applications or conditions. Otherwise, safety functions equipped with the instrument will not work, and instrument damage or serious personal injury may occur. Verify proper operation on a known source before taking action as a result of the indication of the instrument.
- With attention to the measurement category to which the object under test belongs, do not make measurements on a circuit in which the electrical potential exceeds the following values. \* 300V AC for CAT. IV, 600V AC for CAT. III, 1000V AC for CAT. II
- Do not attempt to make measurement in the presence of flammable gasses. Otherwise, the use of the instrument may cause sparking, which can lead to an explosion.
- Never attempt to use the instrument if its surface or your hand is wet.

### **Measurement**

- Do not exceed the maximum allowable input of any measuring range.
- Never open the battery compartment cover during a measurement.

### **Battery**

- Do not try to replace batteries during a measurement.
- Brand and type of the batteries to be used should be harmonized.

### **Power cord**

- Connect the power cord to an outlet.
- Use only the power cord supplied with this instrument.

### **Power supply connector**

- Never touch the power supply connector although it is insulated while the instrument is operating with batteries.

### **Voltage test leads**

- Use only the ones supplied with this instrument.
- Choose and use the test leads and caps that are suitable for the measurement category.
- When the instrument and the test lead are combined and used together, whichever lower category either of them belongs to will be applied. Confirm that the measured voltage rating of the test lead is not exceeded.

## SAFETY WARNINGS

---

- Do not connect a voltage test lead unless required for measuring the desired parameters.
- Connect voltage test leads to the instrument first, and only then connect them to the circuit under test.
- Keep your fingers behind the barrier during a measurement. Barrier: provides protection against electrical shock and ensuring the minimum required air and creepage distances.
- Never disconnect the voltage test leads from the connectors of the instrument during a measurement (while the instrument is energized).
- Do not touch two lines under test with the metal tips of the test leads.
- Never touch the metal tips of the test leads.

### Clamp sensor

- Use only the ones dedicated for this instrument.
- Confirm that the measured current rating of the test lead and the maximum rated voltage are not exceeded.
- Do not connect a clamp sensor unless required for measuring the desired parameters.
- Connect sensors to the instrument first, and only then connect them to the circuit under test.
- Keep your fingers behind the barrier during a measurement. Barrier: provides protection against electrical shock and ensuring the minimum required air and creepage distances.
- Never disconnect sensors from the connectors of the instrument while the instrument is in use.
- Connect to the downstream side of a circuit breaker since a current capacity at the upstream side is larger.
- Do not touch two lines under test with the metal tips of the test leads.

### CAUTION

- Caution should be taken since conductors under test may be hot.
- Never apply currents or voltages exceeding the maximum allowable input for the instrument for a long time.
- Do not apply currents or voltages for the clamp sensors or voltage test leads while the instrument is off.
- Don't use the instrument in dirty or dusty environments.
- Don't use the instrument under a strong electric storm or in the vicinity of energized object.
- Never give strong vibrations or drop shocks.
- Insert an SD card to the slot with the top side turned up. If the card is inserted up-side-down, the SD card or the instrument may be damaged.
- While using an SD card, do not replace or remove the card. (The  symbol blinks while accessing SD card.) Otherwise, the saved data in the card may be lost or the instrument may be damaged.

## SAFETY WARNINGS

### Clamp sensor





- Do not bend or pull the cable of the clamp sensor.

### Treatment after use

- Power off the instrument and disconnect the power cord, voltage test leads and clamp sensors from the instrument.
- Remove the batteries if the instrument is to be stored and will not be in use for a long period.
- Remove the SD card when carrying the instrument.
- Never give strong vibrations or drop shocks when carrying the instrument.
- Do not expose the instrument to direct sunlight, high temperatures, humidity or dew.
- Use a damp cloth with neutral detergent or water for cleaning the instrument. Do not use abrasives or solvents.
- Do not store the instrument if it is wet.

Carefully read and follow the instructions: **⚠ DANGER**, **⚠ WARNING**, **⚠ CAUTION** and **NOTE ( )** described in each section.

Meaning of symbols on the instrument:

	Caution! Refer to the explanation in this Manual.
	The equipment is protected by double insulation or reinforced insulation.
	Alternating Current (AC).
	Earth (Ground).

## *UNPACKING AND INSPECTION*

---

Your shipping carton should include:

- 1 DM-5 power quality meter
- 1 CT-53 flex AC current clamp
- 1 CT-500 flex AC current clamp
- 4 Test lead with alligator clip (red/black/blue/green)
- 1 US power cord
- 1 SD card (2G)
- 1 USB cable
- 32 Cable tie (8 colors)
- 6 AA batteries
- 1 User manual
- 1 PC Software (CD ROM)
- 1 Carrying case

If any of the items are damaged or missing, return the complete package to the place of purchase for an exchange.

**The included printed manual is a simplified version of the full instruction manual which can be found on the supplied CD-ROM. This manual is intended only as a handy reference guide and should only be used after having read the full instruction manual which contains full details on each function of this instrument and the items contained in the package.**



# 1. INSTRUMENT OVERVIEW

## 1.1 Functional overview

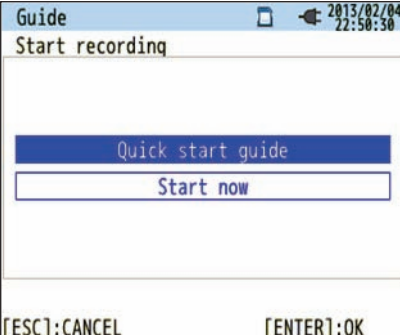
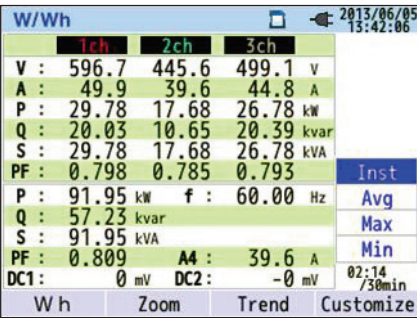
<b>START /STOP</b>	<p><b>Start/ Stop</b> Choose either "Quick start guide" or "Start now" to start recording. Perform simple and fast start-up setting by selecting "Quick start guide".</p>  <p>[ESC]:CANCEL                      [ENTER]:OK</p> <p>See "Start/Stop Recording" for further details.</p>																																																					
<b>W/Wh</b>	<p><b>Inst/ Integration/ Demand</b> Display the avg/ max/ min instantaneous values of current/ voltage/ active power/ apparent power/ reactive power. Integration values also can be viewed by switching screens. Moreover, demand values with the preset target value can also be checked.</p>  <table border="1"><thead><tr><th></th><th>1ch</th><th>2ch</th><th>3ch</th><th></th></tr></thead><tbody><tr><td>V :</td><td>596.7</td><td>445.6</td><td>499.1</td><td>V</td></tr><tr><td>A :</td><td>49.9</td><td>39.6</td><td>44.8</td><td>A</td></tr><tr><td>P :</td><td>29.78</td><td>17.68</td><td>26.78</td><td>kW</td></tr><tr><td>Q :</td><td>20.03</td><td>10.65</td><td>20.39</td><td>kvar</td></tr><tr><td>S :</td><td>29.78</td><td>17.68</td><td>26.78</td><td>kVA</td></tr><tr><td>PF :</td><td>0.798</td><td>0.785</td><td>0.793</td><td></td></tr></tbody></table> <table border="1"><thead><tr><th></th><th>Inst</th></tr></thead><tbody><tr><td>P :</td><td>91.95 kW</td></tr><tr><td>Q :</td><td>57.23 kvar</td></tr><tr><td>S :</td><td>91.95 kVA</td></tr><tr><td>PF :</td><td>0.809</td></tr><tr><td>f :</td><td>60.00 Hz</td></tr><tr><td>A4 :</td><td>39.6 A</td></tr><tr><td>DC1 :</td><td>0 mV</td></tr><tr><td>DC2 :</td><td>-0 mV</td></tr></tbody></table> <p>02:14 /30min</p> <p>W h    Zoom    Trend    Customize</p> <p>See "Inst/ Integration/ Demand" for further details.</p>		1ch	2ch	3ch		V :	596.7	445.6	499.1	V	A :	49.9	39.6	44.8	A	P :	29.78	17.68	26.78	kW	Q :	20.03	10.65	20.39	kvar	S :	29.78	17.68	26.78	kVA	PF :	0.798	0.785	0.793			Inst	P :	91.95 kW	Q :	57.23 kvar	S :	91.95 kVA	PF :	0.809	f :	60.00 Hz	A4 :	39.6 A	DC1 :	0 mV	DC2 :	-0 mV
	1ch	2ch	3ch																																																			
V :	596.7	445.6	499.1	V																																																		
A :	49.9	39.6	44.8	A																																																		
P :	29.78	17.68	26.78	kW																																																		
Q :	20.03	10.65	20.39	kvar																																																		
S :	29.78	17.68	26.78	kVA																																																		
PF :	0.798	0.785	0.793																																																			
	Inst																																																					
P :	91.95 kW																																																					
Q :	57.23 kvar																																																					
S :	91.95 kVA																																																					
PF :	0.809																																																					
f :	60.00 Hz																																																					
A4 :	39.6 A																																																					
DC1 :	0 mV																																																					
DC2 :	-0 mV																																																					

**Vector and Wiring Check**  
 Vectors of voltage and current per CH are displayed on a graph. DM-5 will perform wiring check.

V1	199.8 V	-0.0°
V2	200.0 V	119.9°
V3	198.9 V	-120.0°
A1	500.2 A	5.1°
A2	499.0 A	125.1°
A3	500.2 A	-114.7°

f 55.00Hz  
 Unbalance  
 V 0.1%  
 A 0.2%

See "Vector" for further details.

**Waveform**  
 Waveforms of voltage and current per CH are displayed on a graph.

V:	238.4	242.7	235.9
A:	48.3	48.3	47.1

See "Waveform" for further details.

**Harmonic Analysis**  
 Harmonic components of voltage and current per CH are displayed on a graph.

A:	11.5	12.8	11.5	12.9
THD:	27.48	24.65	27.22	24.71

60.02Hz

See "Harmonic Analysis" for further details.

**Power Quality (QUALITY) event**  
 Display voltage swell, dip, int, transient, inrush current and flicker.

**QUALITY** 2013/07/18 10:48:12

All events	Occurrence
101.0 V	2013/07/18 10:45:43.136
50.4 V	2013/07/18 10:45:43.136
87.1 V	2013/07/18 10:45:35.136
128.5 V	2013/07/18 10:45:27.136
-217.1 V	2013/07/18 10:45:27.136
50.4 V	2013/07/18 10:45:18.136
87.1 V	2013/07/18 10:45:10.136
128.5 V	2013/07/18 10:45:02.136

Flicker Detection

See "Power Quality" for further details.

**Setting (SET UP)**  
 Make settings for DM-5 and measurements.

**SET UP** 10/22/2015 14:21:08

Basic Meas. Rec. Save Others

**Wiring**

Wiring	3P4W
+Clamp	OFF

**Voltage**

V Range	600V
VT Ratio	1.00
Nominal V	200V

**Current**

Clamp	1,2,3ch
CT	CT-500
A Range	1000 A

Diagram Detect

See "Setting" for further details.

# 1. INSTRUMENT OVERVIEW

---

## 1.2 Features

This is a clamp-type power quality analyzer that can be used for various wiring systems. It can be used for simple measurements of instantaneous/ integration/ demand values, and also for analysis of harmonics and events related to power quality and for the simulation of power factor correction with capacitor banks. It can display waveforms and vectors of voltage and current. Data can be saved either on the SD card or in the internal memory, and can be transferred to a PC via USB, or in real-time via wireless connectivity with a compatible Bluetooth® enabled device.

### Safety construction

Designed to meet the international safety standard IEC 61010-1 CAT.IV 300V/ CAT.III 600V/ CAT.II 1000V.

### Power quality analysis

DM-5 is designed to meet the international standard IEC61000-4-30 Class S and can measure frequency and r.m.s. voltage with high accuracy, and also can analyze harmonics. Moreover, it can measure swell, dip, interruption, transient, inrush current and flicker, gapless, all at once.

### Power measurement

DM-5 measures active/reactive/apparent power, electrical energy, power factor, r.m.s. current, phase angle and neutral current simultaneously.

### Wiring configuration

DM-5 supports: Single-phase 2-wire (4-system), Single-phase 3-wire (2-system), Three-phase 3-wire (2-system) and Three-phase 4-wire.

### Demand measurement

Electricity consumption can be easily monitored so as not to exceed the target maximum demand values.

### Waveform/ vector display

Voltage and current can be displayed by waveform or vector.

### Saving data

The DM-5 features a logging function with preset recording intervals. Data can be saved by manual operation or by specifying date and time. A screenshot of the data on the screen can be saved by using the Print Screen function.

### Dual power supply system

DM-5 operates either with AC power supply or with batteries. Size AA alkaline dry-cell batteries and size AA Ni-MH rechargeable batteries can both be used. To charge size AA Ni-MH rechargeable batteries, use the charger which is manufactured by the same company as the batteries. In the event of power interruption, while operating with AC power supply, power to the instrument is automatically restored by the batteries in the instrument.

### Large display

TFT color display with large screen.

## 1. INSTRUMENT OVERVIEW

---

### Compact design

Compact power quality analyzer.

### Application

Data in the SD card or the internal memory can be saved in PC via USB. Analysis of the downloaded data and instrument settings are possible by using the special software "Windows for DM-5".

Real-time communication with compatible devices is available via wireless connectivity to Bluetooth® enabled devices.

### Input/ Output function

Analog signals from thermometers or light sensors can be measured simultaneously with electrical power data via 2 analog inputs (DC voltage); when any events related to power quality occur, signals can be transmitted to alarm devices via one digital output.

# 1. INSTRUMENT OVERVIEW

## 1.3 Constructional drawing

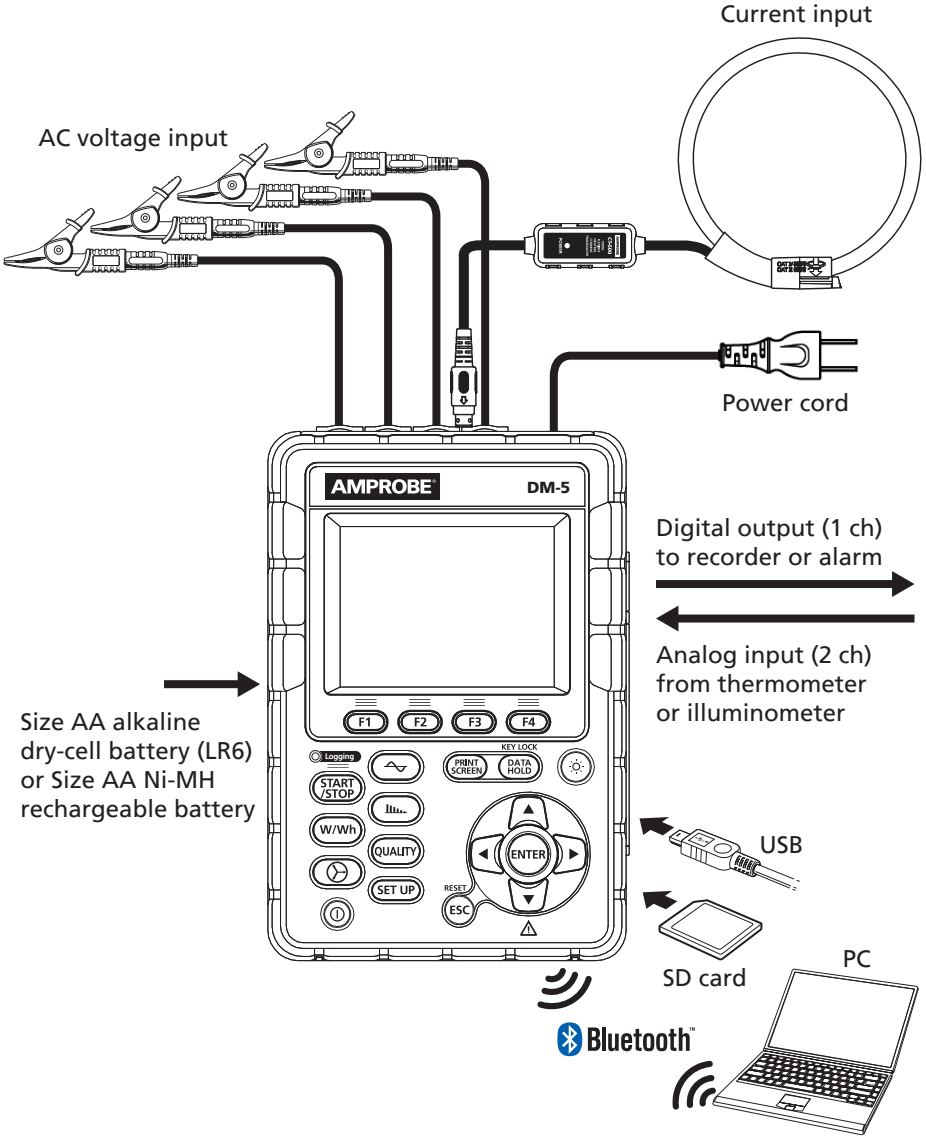

# 1. INSTRUMENT OVERVIEW

---

## 1.4 Steps for measurement

Read through the operating instructions described in “Safety warnings” (P.8) before starting to use the instrument.

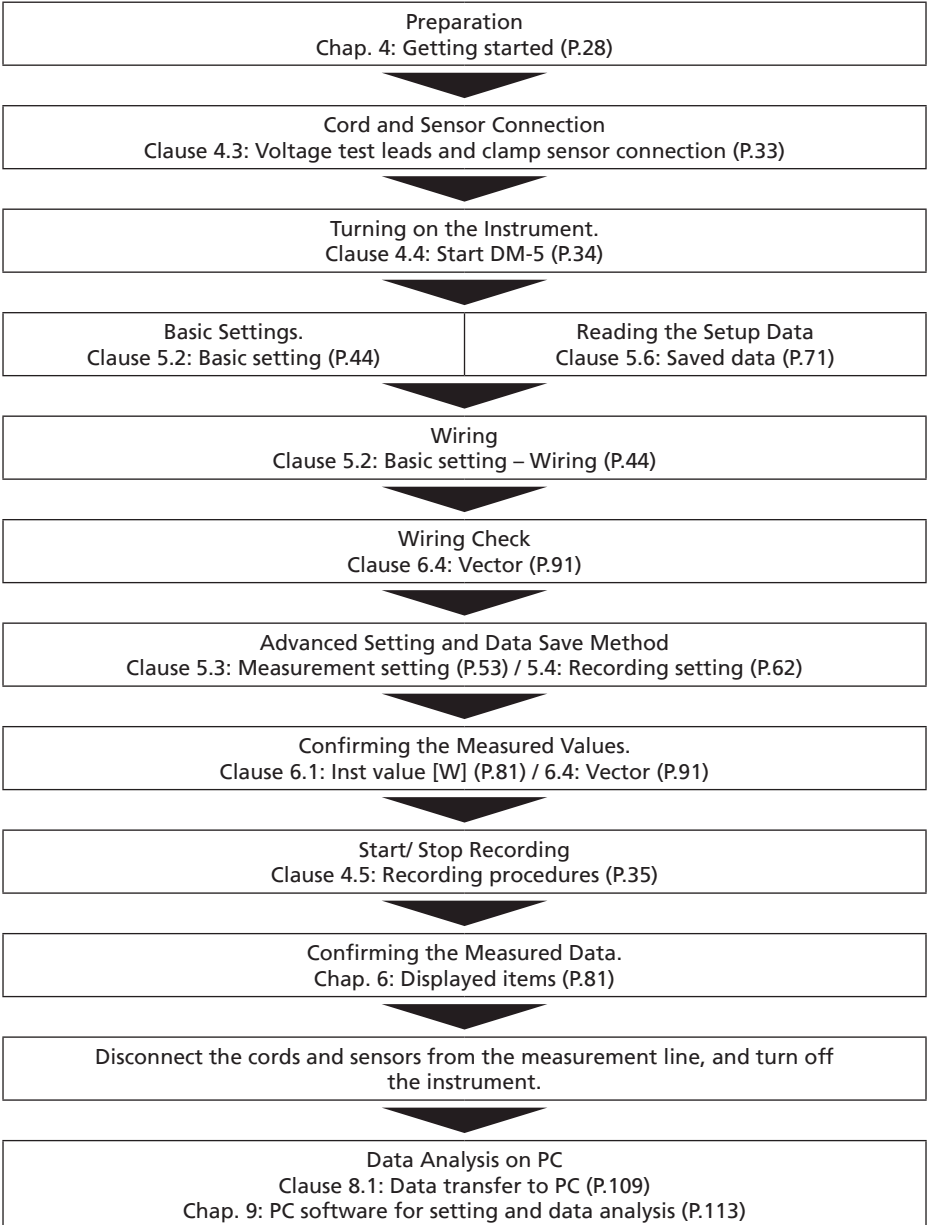

2. INSTRUMENT LAYOUT

2.1 Display (LCD)/ Keys

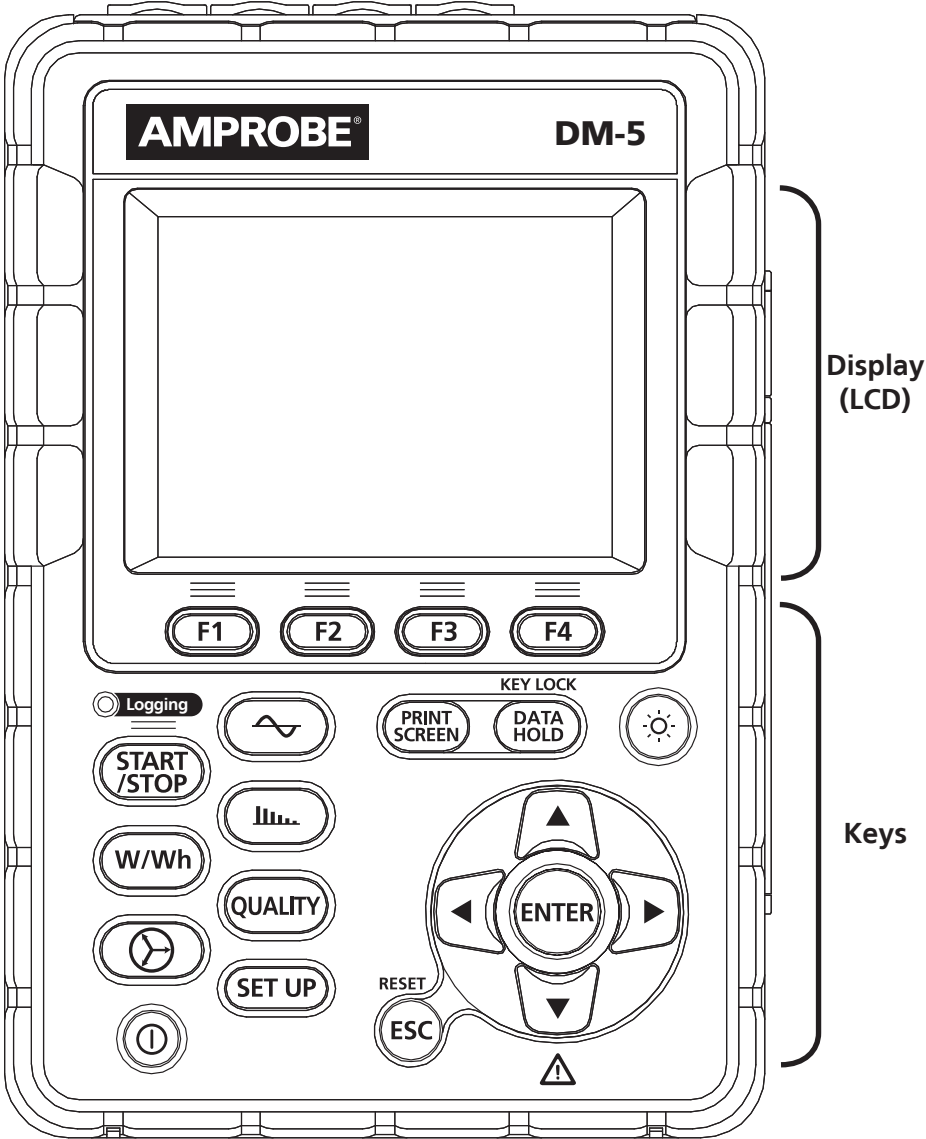



## 2. INSTRUMENT LAYOUT

### 2.2 Connector

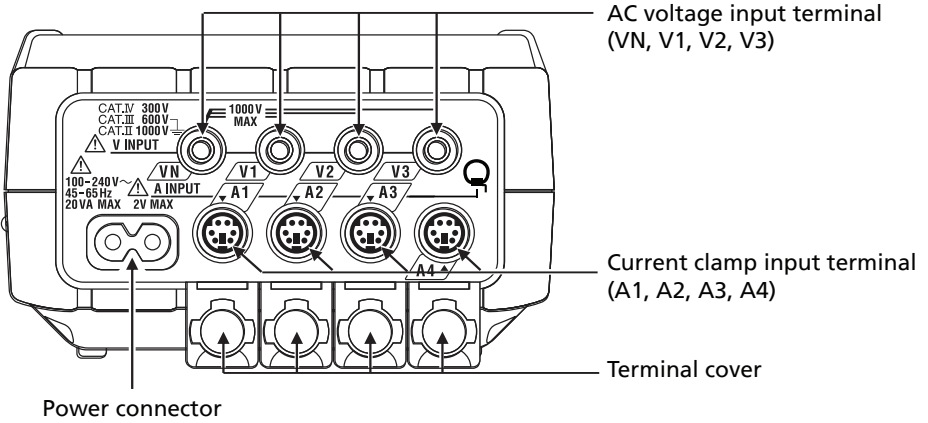

Wiring configuration		AC Voltage Input Terminal	Current Input Terminal*
Single-phase 2-wire (1-system)	1P2W×1	VN, V1	A1
Single-phase 2-wire (2-system)	1P2W×2	VN, V1	A1, A2
Single-phase 2-wire (3-system)	1P2W×3	VN, V1	A1, A2, A3
Single-phase 2-wire (4-system)	1P2W×4	VN, V1	A1, A2, A3, A4
Single-phase 3-wire (1-system)	1P3W×1	VN, V1, V2	A1, A2
Single-phase 3-wire (2-system)	1P3W×2	VN, V1, V2	A1, A2, A3, A4
Three-phase 3-wire (1-system)	3P3W×1	VN, V1, V2	A1, A2
Three-phase 3-wire (2-system)	3P3W×2	VN, V1, V2	A1, A2, A3, A4
Three-phase 3-wire 3A	3P3W3A	V1, V2, V3	A1, A2, A3
Three-phase 4-wire	3P4W×1	VN, V1, V2, V3	A1, A2, A3

\* Measurements of r.m.s. values and harmonics are possible at the Current terminals, which are not used for wiring connection.

## 2. INSTRUMENT LAYOUT

### 2.3 Side face

When the connector cover is closed.

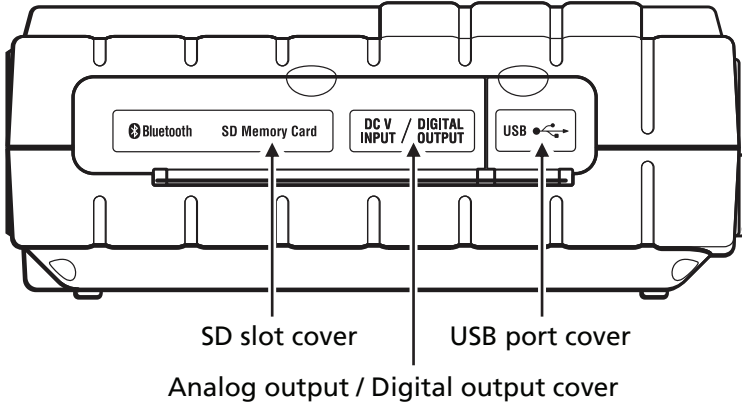

When the connector cover is opened.

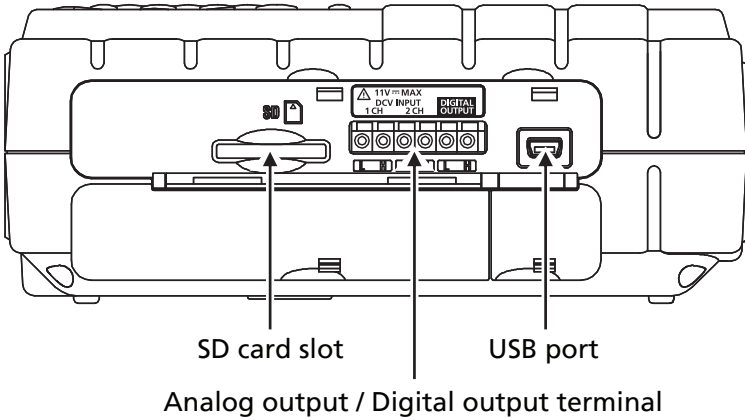

## 2. INSTRUMENT LAYOUT

### 2.4 Voltage test lead and clamp sensor

Alligator clip \* Attached to the top part of voltage test lead

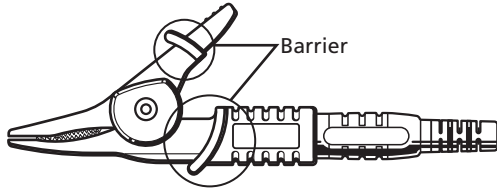

Barrier is a mechanical safety part and provides protection against electrical shock and ensuring the minimum required air and creepage distances. Keep your fingers and hands behind the barrier during a measurement.

CT-53

Coupling point of the measuring head

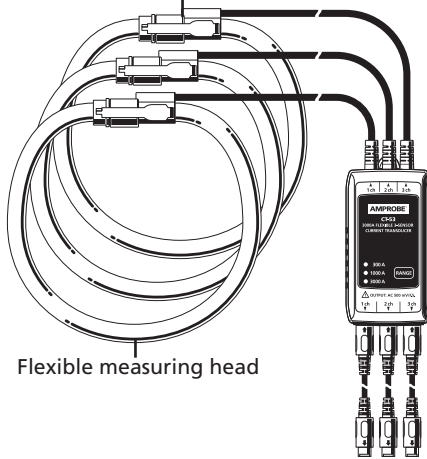

Flexible measuring head

CT-500

Flexible measuring head

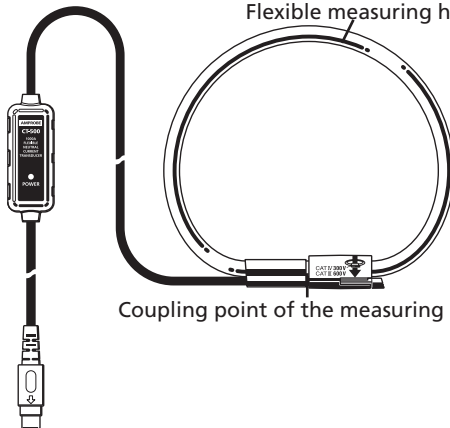

Coupling point of the measuring head

### 3. BASIC OPERATIONS

#### 3.1 Key operation

The diagram shows the AMPROBE IM-5 device with various keys and their functions detailed in callout boxes. The device features a central LCD display, four function keys (F1-F4), a numeric keypad, a directional pad, and several specialized keys like START/STOP, W/Wh, QUALITY, SET UP, ESC, and PRINT SCREEN. A status LED is also present.

<b>Function Key</b>	
	Execute the displayed function.

<b>PRINT SCREEN Key</b>	
	Save the displayed screen as BMP file.

<b>DATA HOLD Key/ KEY LOCK Key</b>	
	Freeze the readings on the display. * Measurement continues while the readings freeze on the display.
	Press > 2 seconds to lock all keys to prevent operational errors. Press > 2 seconds again to resume all keys function

<b>LCD Key</b>	
	Turn on/ off the backlight. Press > 2 seconds to adjust the display brightness and contrast by using ◀ and ▶

<b>Cursor Key</b>	
	Select items or switch displays of measurement parameters.

<b>ENTER Key</b>	
	Confirm the entries.

<b>ESC Key/ RESET Key</b>	
	Cancel setting changes and return to the previous settings.

<b>START / STOP Key</b>	
	Start / stop measurement.

<b>Power Key</b>	
	Power on / off.

















<b>Status LED</b>	
Green	On: Recording & measuring OBlink: Stand-by
Red	Blink: Backlight is off.

<b>SETUP Key</b>	
	Set up menu for Basic, Measurement, Recording, other settings, and edit the saved data.

<b>Menu Key</b>					
	<b>W/Wh</b>	View inst, integration and demand values.		<b>Harmonic Analysis</b>	View harmonic voltage, current and power energy.
	<b>Vector</b>	View phases.		<b>Power Quality</b>	View the detailed info about: swell, dip, int, transient, inrush current and flicker.
	<b>Waveform</b>	View voltage/ current waveforms.			

### 3. BASIC OPERATIONS

#### 3.2 Icons on the LCD

Icon	Status
	DM-5 is operating with batteries. This icon varies in 4 steps according to the battery power condition.
	DM-5 is operating with AC power.
	Data hold is activated.
	All keys are locked.
	Buzzer is disabled.
	SD card is inserted and is ready.
	Recording the data on the SD card.
	Available free space in the SD card is not enough.
	Failed to access to the SD card.
	Internal memory is available. * This icon is displayed when a measurement starts without SD card.
	Recording the data in the internal memory.
	Available free space in the internal memory is not enough.
	Stand-by mode
	Recording the measured data.
	Capacity of recording media is full.
	USB cable is connected.
	Bluetooth® connection is established.

### 3. BASIC OPERATIONS

#### 3.3 Symbols on the LCD

V* <sup>1</sup>	Phase voltage	VL* <sup>1</sup>	Line voltage	A	Current
P	Active + consumption power - regenerating	Q	Reactive + lagging power - leading	S	Apparent power
PF	Power + lagging factor - leading	f	Frequency		
DC1	Analog input voltage at 1ch	DC2	Analog input voltage at 2ch		
An* <sup>2</sup>	Neutral current	PA* <sup>3</sup>	Phase + lagging angle - leading	C* <sup>3</sup>	Capacitance calculation
WP+	Active power energy (consumption)	WS+	Apparent power energy (consumption)	WQi+	Reactive power energy (lagging)
WP-	Active power energy (regenerating)	WS-	Apparent power energy (regenerating)	WQc+	Reactive power energy (leading)
THD	Voltage/ Current total distortion factor				
Pst (1min)	Voltage flicker (1 min)	Pst	Short term voltage flicker	Plt	Long term voltage flicker

\*1 W screen: Displays of V and VL can be "customized" when "3P4W" is selected.

\*2 W screen: "An" is displayed only when "3P4W" is selected.

\*3 W screen: Displays of PA and C can be "customized".

#### 3.4 Backlight and Contrast Adjustment

Press and hold  > 2 seconds to enter the backlight brightness and display contrast adjustment mode. Press ▲ and ▼ to select brightness or contrast adjustment. Press ◀ and ▶ to adjust the levels of brightness/contrast. Press the **ENTER** to save the setting and exit the adjustment mode.

Press **ESC** or  Key again to cancel the adjustment and exit the adjustment mode.



##### Brightness adjustment

Backlight brightness can be changed by 11 levels.

##### Contrast adjustment

Contrast can be changed by 11 levels.

### 3. BASIC OPERATIONS

#### 3.5 Screens

**W/Wh**

Inst/ Integration/ Demand values

Press the **F1** button to toggle the screens.

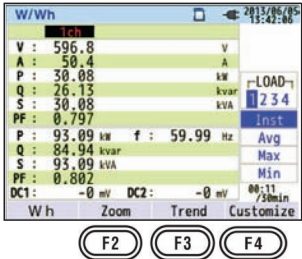
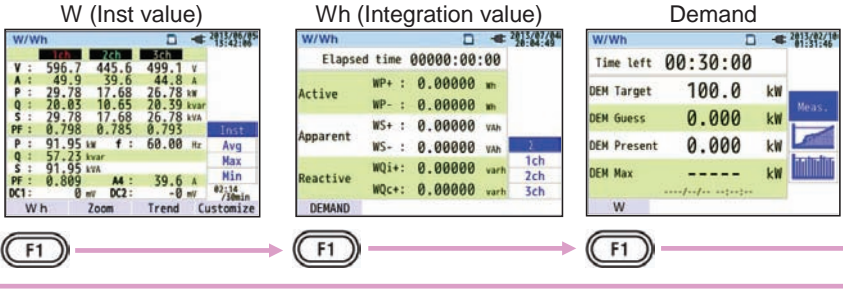

**Customize**  
Select and change the items to be displayed.

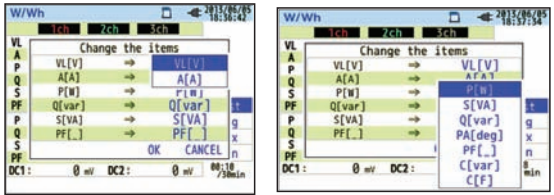

**Zoom**  
Zoom and display the selected items.

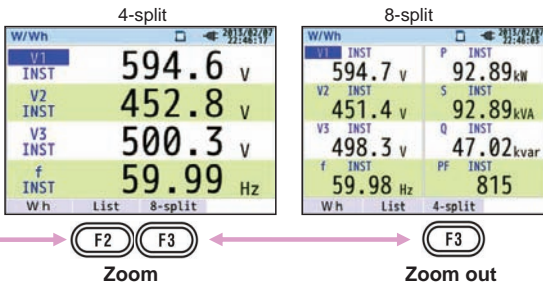

**Trend**  
Changes to the measured values are displayed on a graph to track trends.



### 3. BASIC OPERATIONS

#### Vector

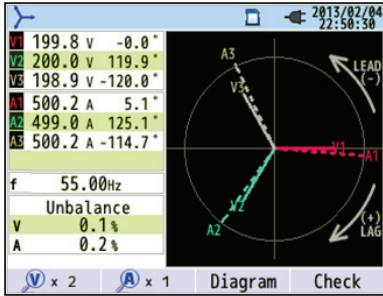

**F1** **F2** **F3** **F4**

#### Wiring diagram

Diagram of the selected wiring is displayed.

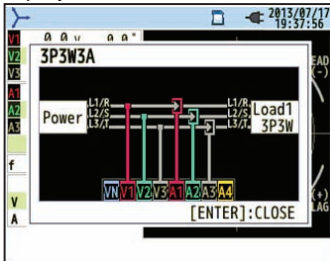

#### Wiring check

Checked results will be displayed.

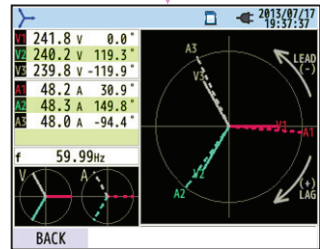
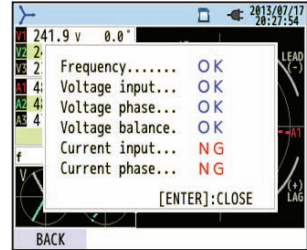

**F1**

**F1** : toggle the line lengths of voltage vector.  
1 → 2 → 5 → 10 \* time(s)

**F2** : toggle the line lengths of current vector.  
1 → 2 → 5 → 10 \* time(s)



### 3. BASIC OPERATIONS

#### Waveform

Select the items with up and down **Cursor** keys and check for the waveforms.

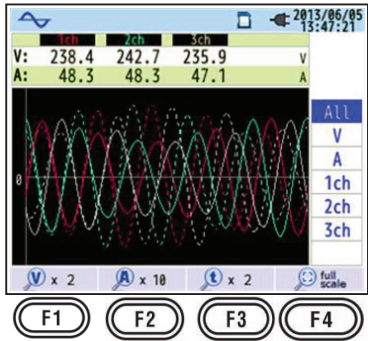
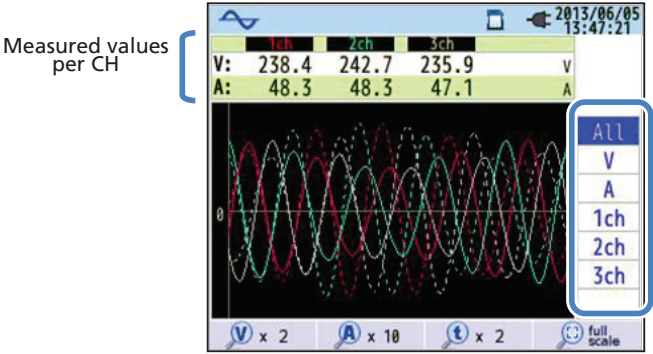

**F1** : toggle the magnifications of voltage waveform (vertical).  
 0.1 → 0.5 → 1 → 2 → 5 → 10 \* time(s)

**F2** : toggle the magnifications of current waveform (vertical).  
 0.1 → 0.5 → 1 → 2 → 5 → 10 \* time(s)

**F3** : toggle the magnifications of time axis (horizontal).  
 1 → 2 → 5 → 10 \* time(s)

**F4** Restore all the changed magnification settings and automatically select the appropriate magnification.

### 3. BASIC OPERATIONS

#### Harmonics



Voltage, Linear, Overall display



Current

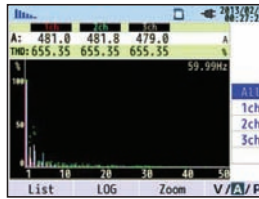

Power

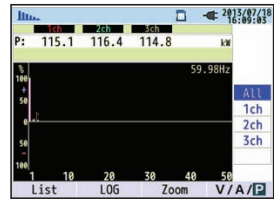

F1 F2 F3 F4

F4

F4

List, Rate of content

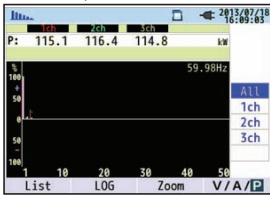

Logarithm

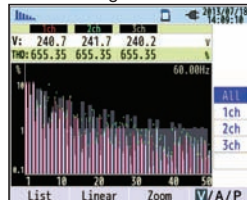

Zoom

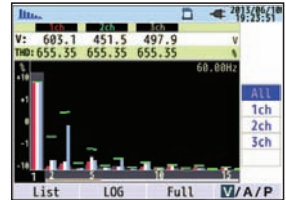

F1 F2 F4

F2

F3

Phase angle

V	V1	V2	V3	
1	0.0	118.2	-119.3	deg
2	10.8	121.0	-119.5	deg
3	3.5	118.9	-119.6	deg
4	-2.6	119.1	-119.2	deg
5	8.7	121.8	-119.0	deg
6	-3.7	119.5	-119.8	deg
7	-2.1	119.9	-119.2	deg
8	4.3	119.4	-119.2	deg
9	-9.5	119.1	-119.1	deg
10	3.7	120.8	-119.5	deg

RMS value

V	V1	V2	V3	
1	599.5	455.6	505.9	v
2	25.8	50.7	134.7	v
3	107.6	35.4	91.1	v
4	19.7	9.1	8.0	v
5	39.8	44.1	36.6	v
6	3.7	4.8	5.9	v
7	7.3	12.6	8.6	v
8	21.0	15.6	3.8	v
9	17.3	10.0	28.0	v
10	8.8	8.2	4.4	v

F2

F2

Current

A	A1	A2	A3	
1	481.4	481.9	478.5	A
2	69.5	137.0	89.3	A
3	213.2	57.3	70.6	A
4	6.0	4.4	9.9	A
5	77.1	94.6	15.9	A
6	24.7	12.1	27.3	A
7	33.3	48.2	47.7	A
8	16.1	5.4	4.2	A
9	26.5	8.8	41.8	A
10	1.4	2.0	5.5	A

Power

P	P1	P2	P3	
1	115.4	115.6	115.3	356.1kW
2	0.8	0.5	5.6	7.2kW
3	24.0	1.6	20.8	47.0kW
4	0.2	0.3	0.2	0.0kW
5	1.0	0.1	2.6	3.5kW
6	0.0	0.0	0.0	0.1kW
7	0.2	1.0	0.0	1.3kW
8	0.0	0.0	0.0	0.0kW
9	0.5	0.1	0.6	1.4kW
10	0.0	0.0	0.0	0.0kW

F4

F4

### 3. BASIC OPERATIONS

#### Power Quality QUALITY

Event

QUALITY			
All events	Occurrence		
101.0 V	2013/07/18	10:45:43.136	
50.4 V	2013/07/18	10:45:43.136	
87.1 V	2013/07/18	10:45:35.136	
128.5 V	2013/07/18	10:45:27.136	
-217.1 V	2013/07/18	10:45:27.136	
50.4 V	2013/07/18	10:45:18.136	
87.1 V	2013/07/18	10:45:10.136	
128.5 V	2013/07/18	10:45:02.136	

Flicker Detection

Flicker

QUALITY				
Pst Calc. ... --:--				
	1ch	2ch	3ch	
V :	230.0	230.4	230.5	V
Pst: 1min	0.804	1.028	1.017	
Pst: MAX	0.804	1.026	1.022	
Plt: MAX	0.804	1.035	1.034	
Plt: MAX	0.804	1.027	1.025	
f : 59.99 Hz				

Event



#### Settings SET UP

Toggle the screens with the Cursor Key.  
(◀ left or ▶ right)

## 4. GETTING STARTED

---

### 4.1 Power supply

DM-5 operates with either an AC power supply or batteries. Capable of performing measurements in the event of AC power interruption, power to the instrument is automatically restored by the batteries installed in the instrument. Size AA alkaline dry-cell batteries (LR6) or size AA Ni-MH batteries can both be used. To charge the rechargeable battery, use the charger which is manufactured by the same company as the batteries. The DM-5 cannot charge batteries.

\* Size AA alkaline dry-cell batteries (LR6) are supplied as accessories.

#### DANGER

- Never open the battery compartment cover during a measurement.
- Brand and type of the batteries to be used should be harmonized.
- Never touch the power supply connector, although it is insulated, while the instrument is operating with batteries.

#### WARNING

- Ensure that the power cord, voltage test leads and clamp sensor are removed from the instrument, and that the instrument is switched off when opening the battery compartment cover for battery replacement.

#### CAUTION

- Never mix new and old batteries.
- Install batteries in correct polarity as marked inside the battery compartment area.







Batteries are not installed in the instrument at the time of purchase. Please insert the supplied batteries before starting to use the instrument. Battery power is consumed even if the instrument is powered off. Remove all the batteries if the instrument is to be stored and will not be in use for an extended period. When the instrument is powered by an AC power supply, it doesn't operate from battery power.

**If an AC supply is interrupted and the batteries have not been inserted, the instrument powers off and all data may lost.**

#### 4. GETTING STARTED

##### Battery Icon on the LCD/ Battery Level

Power supply icon changes as follows, and the battery icon varies according to the battery condition.

Power supply icon	Powered by AC 	Battery level	<b>4-level</b>
	Powered by battery 		 Possible continuous measurement hours: - approx. 3 hours with size AA alkaline batteries, and - approx. 4.5 hours with size AA Ni-MH (1900mA/h) batteries. * These are ref. values with LCD turned off.
			 Instrument works normally. * Voltage of full-charged Ni-MH battery is lower than the one of the full-charged alkaline battery, so the level indicator may not be the same as the one shown above even after fully charged.
			 Measurement continues, but data save is stopped. (the data measured before the battery level drops to the lowest level are saved)
			

W/Wh				06/01/2014 15:54:20
	<b>1ch</b>	<b>2ch</b>	<b>3ch</b>	
V :	200.0	200.1	199.7	v
A :	450.1	448.9	299.6	A
P :	90.0	89.2	58.9	kW
Q :	2.8	-10.5	10.4	kvar
S :	90.0	89.8	59.8	kVA
PF :	0.999	-0.992	0.984	
P :	238.4 kW	f :	50.00	Hz
Q :	2.5 kvar			
S :	240.0 kVA	A4 :	448.9	A
PF :	0.993	An :	248.6	A
DC1 :	0 mV	DC2 :	0 mV	
				03:54 /30min
Wh	Zoom	Trend	Customize	



## 4. GETTING STARTED

Follow the procedure below, and connect the power cord.

1. Confirm that the instrument is powered off.
2. Connect the power cord to the power connector on the instrument.
3. \* Connect another end of the power cord to the outlet.

\* Powering on the DM-5 is possible two seconds after it is connected to a power source. The



Key does not function within this two second period.

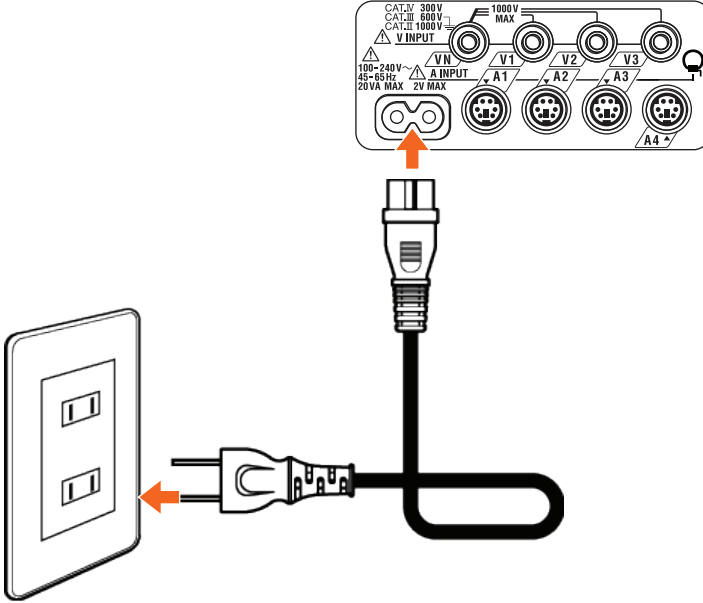

### Power Supply Rating

Rating of power supply is as follows.



Rated supply voltage	100 to 240V AC ( $\pm 10\%$ )
Rated power supply frequency	45 to 65Hz
Max power consumption	7VA max

## 4. GETTING STARTED

### 4.2 Placing / Removing SD card

⚠ Check the following points before using SD card.

#### ⚠ CAUTION

- Follow the instructions described in "Inserting SD card" and insert the SD card into the slot with the top side turned up. If the card is inserted up-side-down, the SD card or the instrument may be damaged.
- While using an SD card, do not replace or remove the card. (The  symbol blinks while accessing SD card.) Otherwise, the saved data in the card may be lost or the instrument may be damaged.
- The indicator "  " blinks during data recording. Do not remove the SD card. Otherwise, the saved data or the instrument may be damaged. Do not remove the card until the recording ends and the pop-up message "Stop recording" disappears.

Notes:

- Newly purchased SD cards must be formatted with the DM-5 before use. Data might not be successfully saved on SD cards that are formatted externally. For details, please refer to "Format" (P.86) in this manual.
- If the SD card has been frequently used for a long period, the life of the flash memory may be expired and additional data may not be saved. In such a case, replace the card with a new one.
- The data in the SD card might be damaged or lost by accident or failure. It is recommended to backup the recorded data periodically. Amprobe will not be liable for any loss of data or any other damages or losses.

#### Inserting SD Card:

1. Open the connector cover.
2. Insert the SD card into the SD card slot with the topside turned up.
3. Then close the cover.

#### Removing SD Card:

1. Open the connector cover.
2. Gently push the SD card towards the inside of the instrument, and then the card should release.
3. Remove the card slowly.
4. Then close the cover.

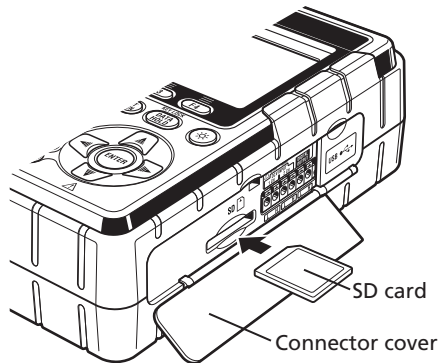



## 4. GETTING STARTED

### 4.3 Voltage Test Leads and Clamp Sensor Connection

⚠ Check the following before connecting the test leads and sensors.

#### ⚠ DANGER

- Use only the voltage test leads supplied with this instrument.
- Use the dedicated clamp sensors for this instrument, and confirm that the measurement current rating of the clamp sensor is not exceeded.
- Do not connect all the voltage test leads or clamp sensors unless required for measuring the desired parameters.
- Connect the test leads and sensors to the instrument first, and only then connect them to the circuit under test.
- Never disconnect the voltage test leads and sensors while the instrument is in use.

#### ⚠ WARNING

- Confirm that the instrument is powered off, and then connect the power cord.
- Connect the power cord to the instrument first. The cord should be firmly connected.
- Never attempt to make measurement if any abnormal conditions are noted, such as a broken cover and exposed metal parts.

Follow the procedure below, and connect the voltage test leads and clamp sensors.

1. Confirm that the instrument is powered off.
2. Connect the appropriate voltage test lead to the AC voltage input terminal on the instrument.
3. Connect the appropriate clamp sensor to the current input terminal on the instrument. Match the direction of the arrow mark indicated on the output terminal of the clamp sensor and the mark on the current input terminal on the instrument.

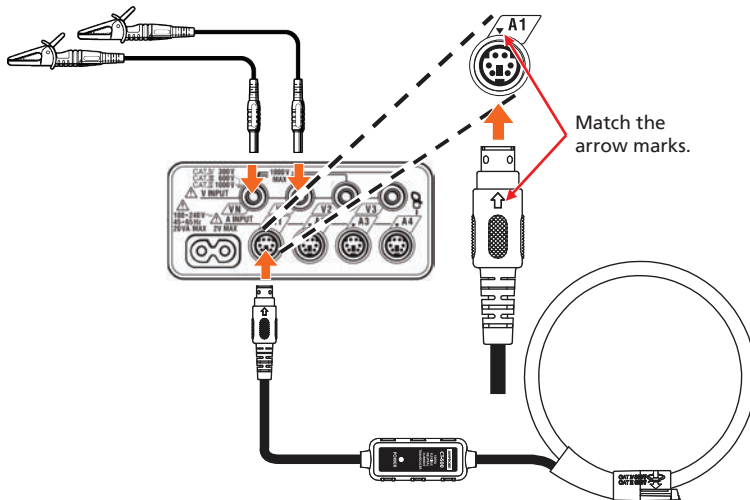

Number of voltage test leads and clamp sensors to be used will be different depending on the wiring configuration under test. For further details, refer to **“Wiring diagrams”** in this manual.

## 4. GETTING STARTED

---

### 4.4 Start DM-5

#### Start-up Screen

Hold down the POWER key until the following screen is displayed on the LCD. To power off the instrument, hold down the POWER key at least two seconds.

1. Model name and software version will be displayed upon powering on the instrument. Stop using the instrument if it does not start up properly, and refer to the "Troubleshooting" in the instruction manual.



2. If this is not the first time starting the instrument, the most recently performed operation will appear on the screen.

#### Cautionary Message

If the connected clamp sensors are not the same ones used during the previous test, the list of the connected sensors will be displayed for five sec; but the settings will not be updated automatically. Press the **SET UP** key and re-detect the sensors or modify the settings directly.

The DM-5 retains and adopts the previous settings if no sensor is connected.

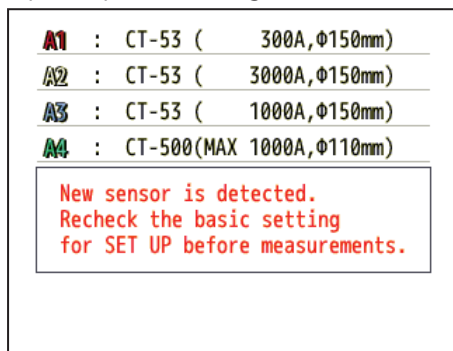

## 4. GETTING STARTED

### 4.5 Recording Procedures

#### Start of Recording

Press the **START/STOP** Key

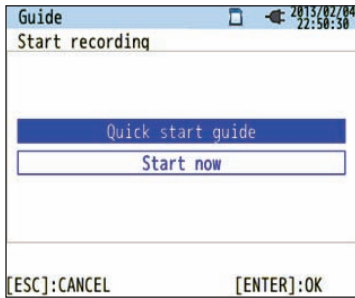

Choose either "Quick start guide" or "Start now" to start recording. Settings for wiring and recording can be quickly and easily selected using the "Quick start guide".

Press the **SET UP** key and adjust advanced settings if necessary. When the necessary settings are already selected, or no change is required, select "Start now" to start recording. Before starting measurement, ensure all safety and necessary preparations have been checked.

Press the **Cursor** Key (▲/▼) to move the **blue highlight** to "Quick start guide" or "Start now".

-> **ENTER** Confirm. **ESC** Cancel.

#### End of Recording

Press the **START/STOP** Key

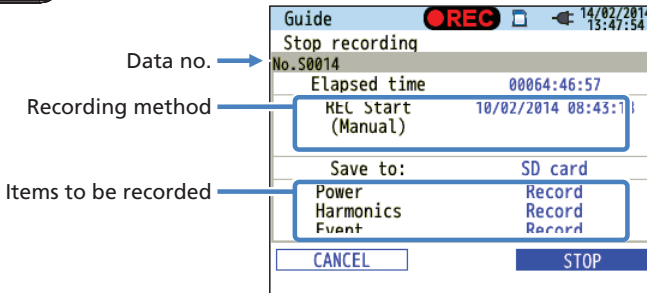

Check the recording information or stop the recording.

Items displayed on the LCD		
Data no.	Data no. of the recorded data. It is also used as a folder name for data saving.	
Elapsed time	The time that elapses while recording.	
Recording method	Manual	Show the "Recording start date and time".
	Constant rec.	Show the "Recording start/ end date and time".
	Time period rec.	Show the "Recording start date and time", "Recording Period" and "Recording Time".
Save to	Data saving location.	
Items recorded	Items being recorded.	

Press the **Cursor** Key (◀/▶) to move the **blue highlight** to "Cancel" or "Stop".

-> **ENTER** Confirm. **ESC** Cancel.

## 4. GETTING STARTED

### Start Measurement with “Quick start guide”

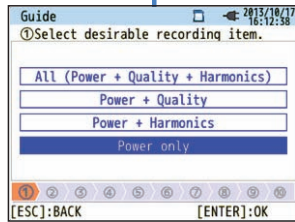

(1) Select the item you want to record.

\* The number of selected items will have effect on file size and also on max recording time.

See SD Card/Saved Data

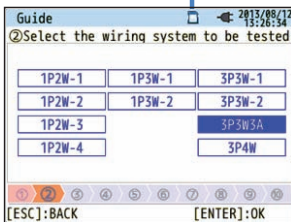

(2) Select the wiring system to be measured.

\* Select a proper wiring system for accurate measurements.

See Wiring System

(3) Connect to the circuit to be tested.

\* Read and follow the safety precautions described in the instruction manual.

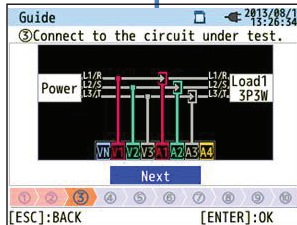

(4)(5) Check the test environment.

\* Self-diagnosis, wiring check and detection of connected sensors will be performed in this test.

\* It is recommended to do this test for ensuring the testing conditions are correct.

See Test Environment

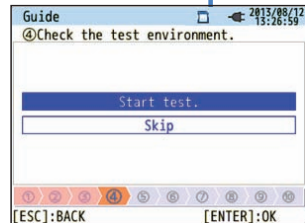

# 4. GETTING STARTED



(6) Select a recording interval.

\* Selecting a short interval gets the file size large. In this case, a long period recording cannot be performed.

See SD Card/Saved Data

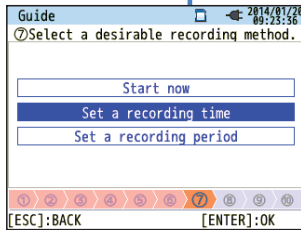

(7)(8)(9) Select a recording method.

See Setting for recording method

(10) Prepared. Recording will start.

The mark "REC" will appear on the screen when the recording starts and the green LED (status indicator) lights up.

If you want to terminate the recording, press

the "START/STOP" button and follow the instructions on-screen instructions.

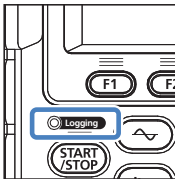
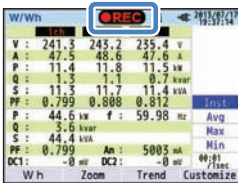
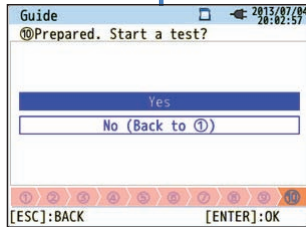

## 4. GETTING STARTED

### Wiring system

Any of the followings can be selected.

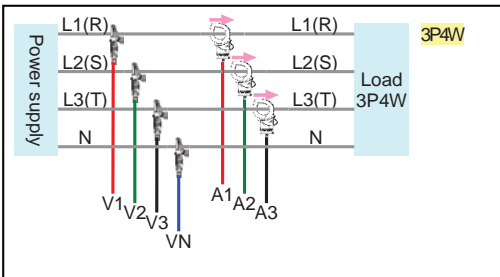
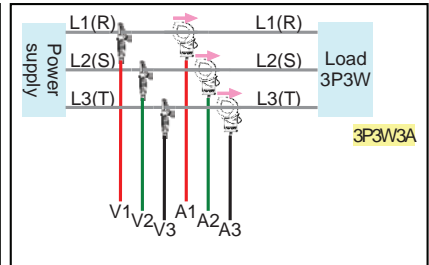
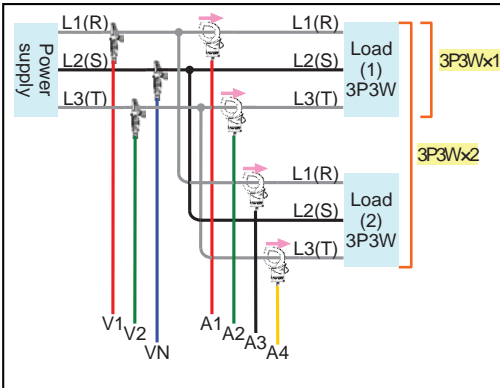
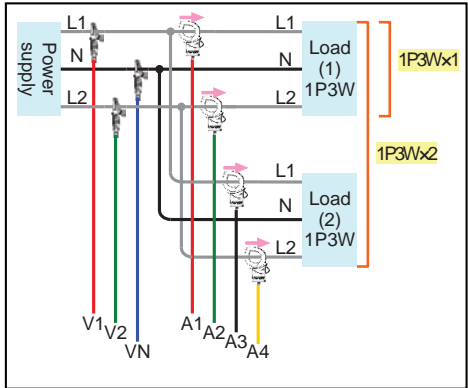
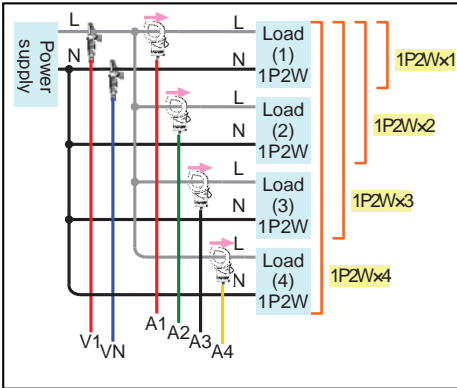

### Orientation of clamp sensor

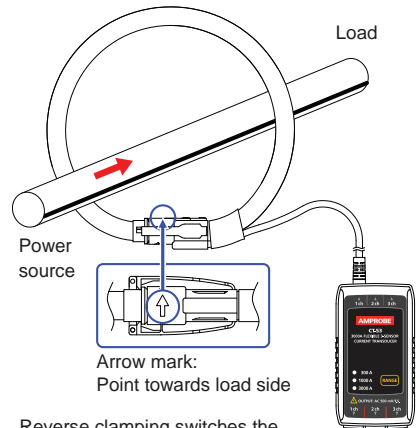

Arrow mark:  
Point towards load side

Reverse clamping switches the symbols (+/-) for active power (P).

## 4. GETTING STARTED

### Test environment check

Select **"Start test"** and press **"ENTER"** button to start the test. The test result will be displayed on the screen.

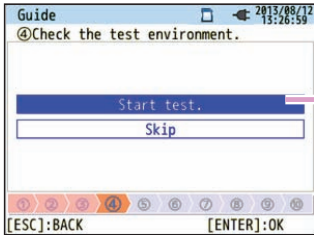

Select and press "ENTER" on **"OK"** / **"NG"** to see the details.

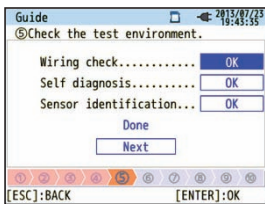

### Wiring check

Test results of each item will be displayed.

\* NG result may be given, even if the wiring is correct, at the measurement site under bad power factors.

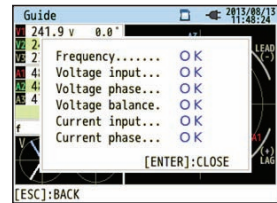

### Self-diagnosis

Operating condition of the instrument system will be checked and the result will be displayed.

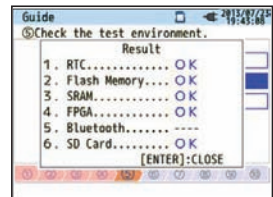

### Sensor detection

The connected sensors are automatically detected and their max ranges will be set.

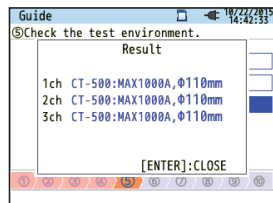

## 4. GETTING STARTED

### NG judgment

#### Wiring check

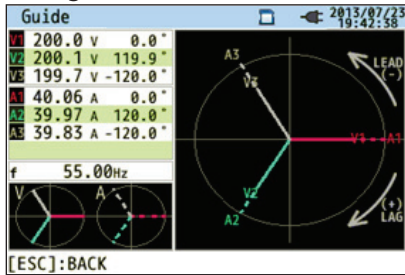

Close the result display. Then, the blinking vectors and the values of NG items will be displayed. If all the results are OK, the ideal vector diagram will be displayed at the lower left corner.

### Criteria of judgment and cause

Check	Check	Check
<b>Frequency</b>	Frequency of V1 is within 40 to 70Hz.	<ul style="list-style-type: none"> <li>- Voltage clip is firmly connected to the circuit?</li> <li>- Measuring too high of harmonic components?</li> </ul>
<b>AC voltage input</b>	AC voltage input is 10% or more of (Nominal voltage x VT).	<ul style="list-style-type: none"> <li>- Voltage clip is firmly connected to the circuit?</li> <li>- Voltage test lead is firmly connected to the AC voltage input terminal on the instrument?</li> </ul>
<b>Voltage balance</b>	AC voltage input is within $\pm 20\%$ of reference voltage (V1). * (not checked in single-phase wiring)	<ul style="list-style-type: none"> <li>- Settings are matched with the wiring system under test?</li> <li>- Voltage clip is firmly connected to the circuit?</li> <li>- Voltage test lead is firmly connected to the AC voltage input terminal on the instrument?</li> </ul>
<b>Voltage phase</b>	Phase of AC voltage input is within $\pm 10^\circ$ of reference value (proper vector).	<ul style="list-style-type: none"> <li>- Voltage test leads are correctly connected? (Connected to proper channels?)</li> </ul>
<b>Current input</b>	Current input is 5% or more and 110% or less of (Current Range x CT).	<ul style="list-style-type: none"> <li>- Clamp sensors are firmly connected to the Power input terminals on the instrument?</li> <li>- Setting for Current Range is appropriate for input levels?</li> </ul>
<b>Current phase</b>	<ul style="list-style-type: none"> <li>- Power factor (PF, absolute value) at each CH is 0.5 or more.</li> <li>- Active power (P) at each CH is positive value.</li> </ul>	<ul style="list-style-type: none"> <li>- Arrow mark on the Clamp sensor and the orientation of flowing current coincide with each other? (Power supply to Load)</li> <li>- Clamp sensors are connected correctly?</li> </ul>



## 4. GETTING STARTED

### Self-diagnosis

If “NG” judgment is given frequently, there might be something wrong with the instrument. Stop using the instrument and refer to “**Troubleshooting**” in the full instruction manual.

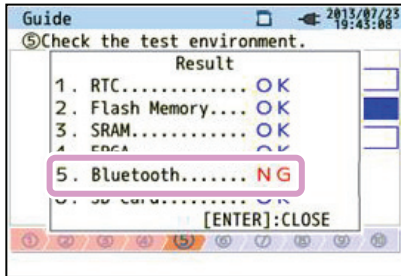

### Sensor detection

If the detection result is NG, each sensor type will be displayed in red.

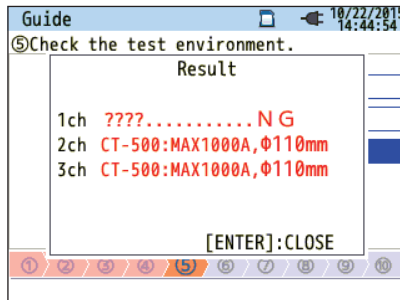
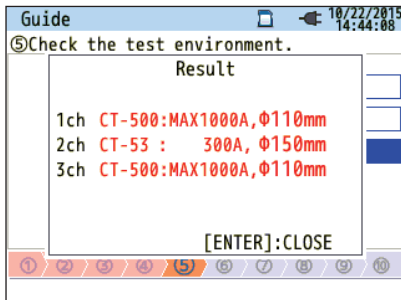

### Criteria of judgment and cause

Causes Check	Causes
Type of current sensor	- Are the types of connected current sensors harmonized? The current sensor types used for measurement should be the same.
Cause unknown	- Current sensors are firmly connected to the instrument? - If any failures are in doubt: Exchange the connections of the sensors and test again. Connect the current sensor, for which “NG” is given, to the CH on which another sensor is properly detected. If the result “NG” is given for the same CH, a defect of the instrument is suspected. A defect of sensor is suspected if “NG” is given for the same sensor connected to another CH. Stop using the instrument and the sensor, if any defects are in doubt, and refer to “ <b>Troubleshooting</b> ” in the instruction manual.

## 4. GETTING STARTED

---

### Setting for recording method

The following explains how to set recording start date and time.

#### Specify the recording start date and time.

The screenshot shows the 'Guide' menu with the title '⑧Set a recording time.' The top right corner displays the date and time '2013/07/04 20:02:57'. The main area contains two input fields: 'REC Start' with the value '2013/08/02 08:00' and 'REC End' with the value '2013/08/07 18:00'. Below these fields is a blue 'Next' button. At the bottom, there is a navigation bar with icons 1 through 10, and the text '[ESC]:BACK' and '[ENTER]:OK'.

During the selected period, DM-5 performs recording at the preset intervals.

Example: When the date & time are specified as above, the recording period will be as follows.  
From 8:00 on August 2, 2013 to 18:00 on August 7, 2013

#### Specify the recording time period.

The screenshot shows the 'Guide' menu with the title '⑨Set a recording period.' The top right corner displays the date and time '2013/08/01 20:24:11'. The main area contains two input fields: 'REC Time' with the value '08:00 ~ 18:00' and 'REC Period' with the value '2013/08/01~2013/08/08'. Below these fields is a blue 'Next' button. At the bottom, there is a navigation bar with icons 1 through 10, and the text '[ESC]:BACK' and '[ENTER]:OK'.

DM-5 performs recording during the selected time period at the preset intervals, and repeats recording processes during the preset time period.

Example: When the time period is specified as above, the recording period is as follows.  
DM-5 does not record data between 18:00 and 8:00.

- (i) 8:00 to 18:00 on August 1, 2013,
- (ii) 8:00 to 18:00 on August 2, 2013,
- (iii) 8:00 to 18:00 on August 3, 2013,
- (iv) 8:00 to 18:00 on August 4, 2013,
- (v) 8:00 to 18:00 on August 5, 2013,
- (vi) 8:00 to 18:00 on August 6, 2013,
- (vii) 8:00 to 18:00 on August 7, 2013, and
- (viii) 8:00 to 18:00 on August 8, 2013.

## 4. GETTING STARTED

### Selecting displayed parameters

For standard functions, the **Cursor** Key  is used for selecting an item, the **ENTER** Key

 is for confirming the selection, and the **ESC** Key is for canceling the alternation. Taking the procedures in "Quick Start Guide" as an example, Key operations are explained as follows.

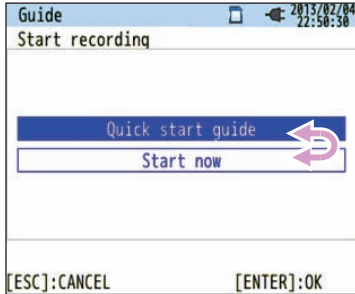

Press the **Cursor** Key to move the **blue highlight**, showing the item is being selected, over the items in blue letters. In the screen at the left is the Recording start screen. Press the **Cursor** Key and move the blue highlight on the desirable recording method, and press the **ENTER** Key to confirm the selection. To quit the start guide, press the **ESC** Key.

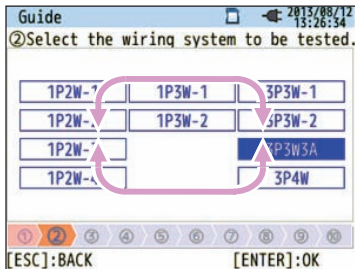

If the display of the **selectable items** is similar to the one shown to the left, then the up, down, right and left **Cursor** Keys can be used. Use the **Cursor** Keys to select the proper wiring system and press the **ENTER** Key to confirm the selection. To return to the previous screen and cancel the changes, press the **ESC** Key.

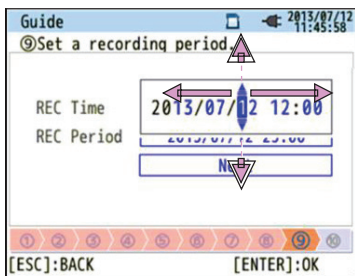

To change the numbers such as **Date / Time**, move the blue highlight over digits with the right and left **Cursor** Keys and alter the number with the up and down **Cursor** Keys.

In the screen to the left, the tenth place of the day is being selected. The number can be increased or decreased by 1 with the up/ down **Cursor** Keys. Press the **ENTER** Key to confirm the selection, or press the **ESC** Key to return to the previous screen and cancel the changes.

### CAUTION



If "AUTO" is setted for "A Range", either "Power + Harmonics" or "Power only" is selectable at step (1): Select desirable recording item. To record power quality, set it to any other proper current ranges other than "AUTO". The "Quick start guide" can be used to select settings for wiring and recording. The following should be selected and entered before starting a recording. Press the **SET UP** key to show the setting screen.

\* Nominal voltage/ frequency, THD for power quality event and filter coefficient (ramp) for flicker measurement. When the setting of "A Range" is set to anything other than "AUTO", the settings for "+ Clamp" will be automatically changed to "OFF".

## 5. SETTINGS

### 5.1 List of Setting Items

Settings must be selected for measurement condition and data saving prior to performing measurements. Press the **SET UP** Key to enter into the SET UP mode and do the necessary settings.

Settings consist of the following five categories. Use the **Cursor** Key  to move between the categories. After making the necessary changes, switch screens and exit from the SET UP screen. Confirm that the  is displayed in the upper left of the LCD at this time. This means the changes are enabled. If the instrument is powered off without switching screens, the changes you made will be cleared.

#### Basic setting

Select settings for the items common to each measurement.

#### Meas. setting

Select settings for each measurement mode.

#### Rec. setting

Select settings for recoding.

#### Saved data

Edit the recorded data or alter the instrument setting.

#### Others

Configure the environmental setting.

#### Each setting

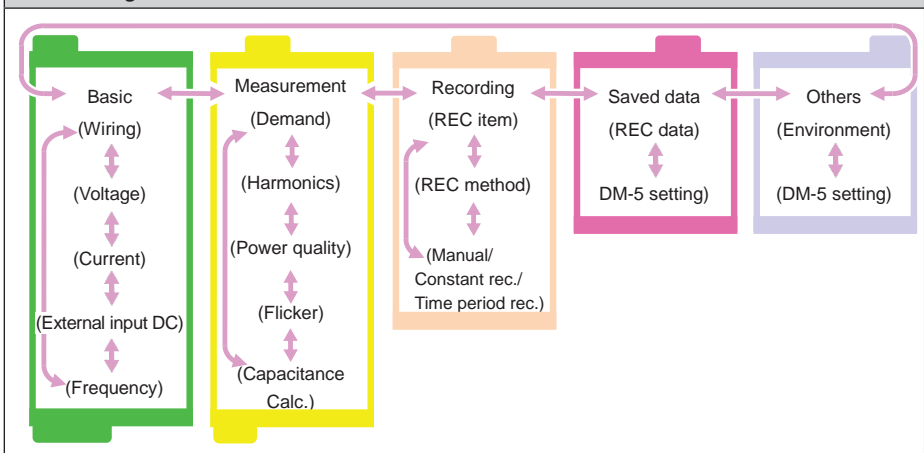

### 5.2 Basic Settings

Press the **SET UP** Key. → Use the **Cursor** Key ◀ and ▶ to display the basic settings screen.

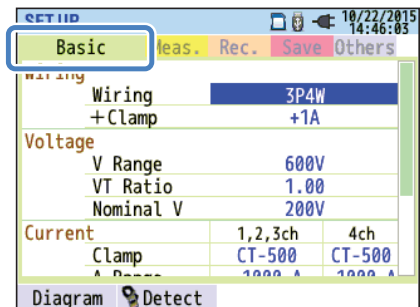

Wiring System Settings

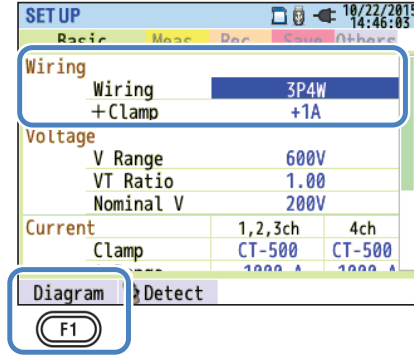

“Basic wiring”

Choose one according to the wiring system to be measured.

Selection		
(1) 1P2W×1	(5) 1P3W×1	(7) 3P3W×1
(2) 1P2W×2	(6) 1P3W×2	(8) 3P3W×2
(3) 1P2W×3		(9) 3P3W3A
(4) 1P2W×4		(10) 3P4W

\* Current terminals that are not used in the selected wiring system can be used to measure rms currents and harmonics.

\* Default setting is highlighted in gray.

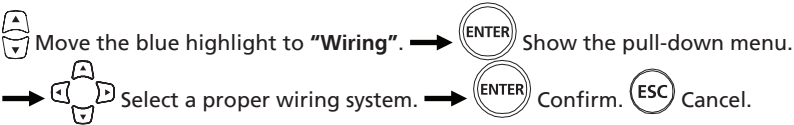

“+ Clamp”: Optional clamp sensors

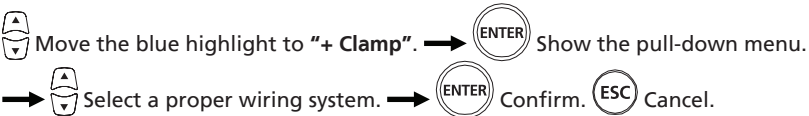

## 5. SETTINGS

### Wiring diagrams

When the blue highlight is located at "Wiring", you can check the wiring diagram of the selected wiring system with the **F1** key. The displayed diagram can be switched with

**F1** or **F2** key.  Confirm.  Cancel.

1P2W-1

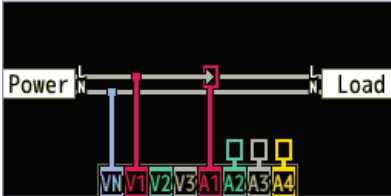

1P2W-2

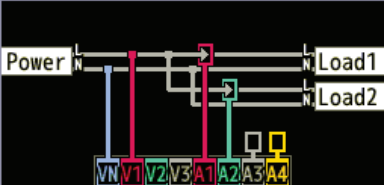

1P2W-3

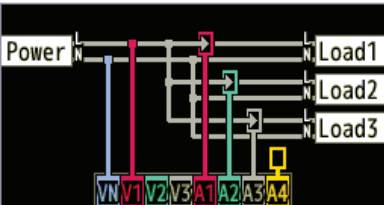

1P2W-4

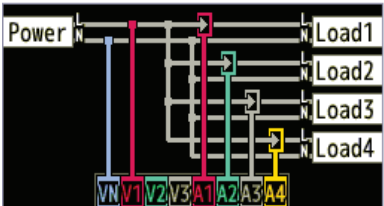

1P3W-1

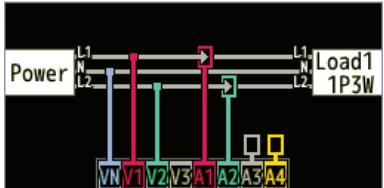

3P4W



3P3W3A

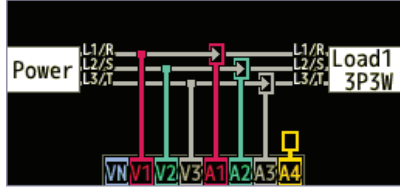

3P3W-2

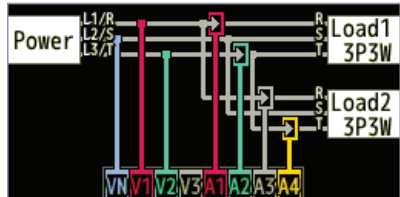

3P3W-1

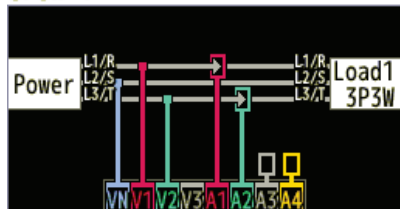

1P3W-2

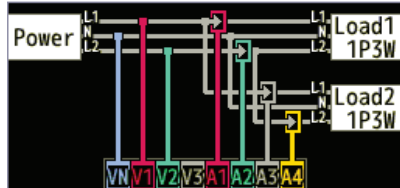

## 5. SETTINGS

**⚠** Read the following precautions prior to connecting wiring.

### **⚠ DANGER**

- With attention to the measurement category to which the object under test belongs, do not perform measurements on a circuit in which the electrical potential exceeds the following values. \* 300V AC for CAT.IV, 600V AC for CAT.III, 1000V AC for CAT.II
- Use only the voltage test leads and clamp sensors dedicated for this instrument.
- Connect the clamp sensors, voltage test leads and power cord to the instrument first, and then connect them to the measured object or the power source.
- When the instrument and the test lead are combined and used together, whichever lower category either of them belongs to will be applied. Confirm that the measured voltage rating of the test lead is not exceeded.
- Do not connect voltage test leads or clamp sensors unless required for measuring the desired parameters.
- Clamp sensors should always be connected on the downstream side of a circuit breaker, which is safer than the upstream side.
- Do not open-circuit the secondary side of a supplementary CT while it is energized because of the high voltage generated at the secondary side terminals.
- Be careful to avoid short-circuiting the power line with the un-insulated part of the voltage test probes during the setup of the instrument. Do not touch the metal tips.
- Transformer jaw tips are designed in such a way to avoid short-circuiting. If the circuit under test has exposed conductive parts, extra care should be taken to minimize the possibility of shorting.
- Keep your fingers behind the barrier during a measurement. Barrier: provides protection against electrical shock and ensuring the minimum required air and creepage distances.
- Never disconnect the voltage test leads from the connectors of the instrument during a measurement (while the instrument is energized).
- Do not touch two lines under test with the metal tips of the test leads.

### **⚠ WARNING**

- To avoid possible electric shock and short-circuit, always turn off the line under test at the wiring connection.
- Do not touch the un-insulated tip of voltage test leads.

**⚠** Clamp sensor direction for correct measurement:

- Confirm that the wiring system selected and the measured line are harmonized.
- Ensure that the arrow mark on the clamp sensor points towards to load side.

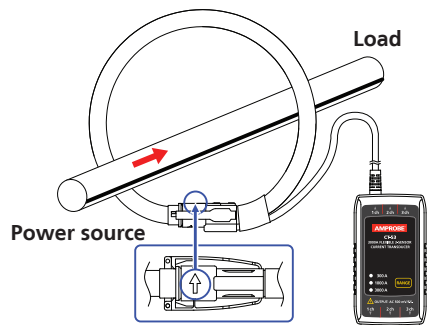

\* Reverse clamping switches the symbols (+/-) for active power (P).

Arrow mark:  
Point towards load side.

Voltage Measurement Settings

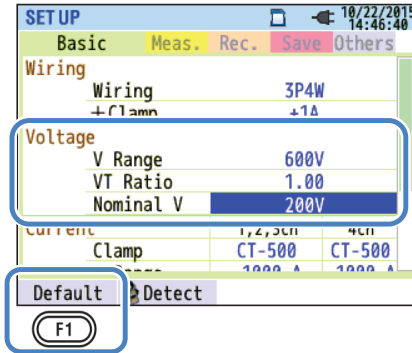

“Voltage range”

Choose a desired voltage range.

\* For measurements according to IEC61000-4-30 Class S, set the range to “600V”.

Selection
600V/1000V

\* Default setting is highlighted in gray.

Move the blue highlight to “V Range”. → Show the pull-down menu.

→ Select a proper wiring system. → Confirm. Cancel.

“VT Ratio”

Set the proper VT ratio when VTs (transformer) are installed in the measured system. The selected VT ratio will be reflected to all the values measured during any voltage measurements.

Selection
0.01 - 9999.99(1.00)

\* Default setting is highlighted in gray.

Move the blue highlight to “VT Ratio”. → Show the value entry window.\*

→ Set the VT Ratio. → Confirm. Cancel.

\* A pop-up appears and shows the effective range.



## 5. SETTINGS

### VT/CT\*

\* Current measurement setting.

#### **⚠ DANGER**

- With attention to the measurement category to which the object under test belongs, do not make measurements on a circuit in which the electrical potential exceeds the following values. \* 300V AC for CAT. IV, 600V AC for CAT. III, 1000V AC for CAT. II
- Never connect the power cord to an outlet of AC240V or higher.
- This instrument must be used on the secondary side of VT (transformer) and CT (current transformer).
- Do not open-circuit the secondary side of the supplementary CT while it is energized because of the high voltage generated at the secondary side terminals.

#### **⚠ CAUTION**

- When a VT or CT is used, the measurement accuracy is not guaranteed due to several factors namely phase characteristics and VT/CT accuracies.

The use of supplementary VT/CT's may be required if the voltage/current values of the circuit under test fall outside the instrument measuring range. In this case the value at the primary side of circuit can be obtained directly by measuring the secondary side with an appropriate VT or CT installed in the line under test as follows.

< Example of single-phase 2-wire (1-system) "1P2W x 1" >

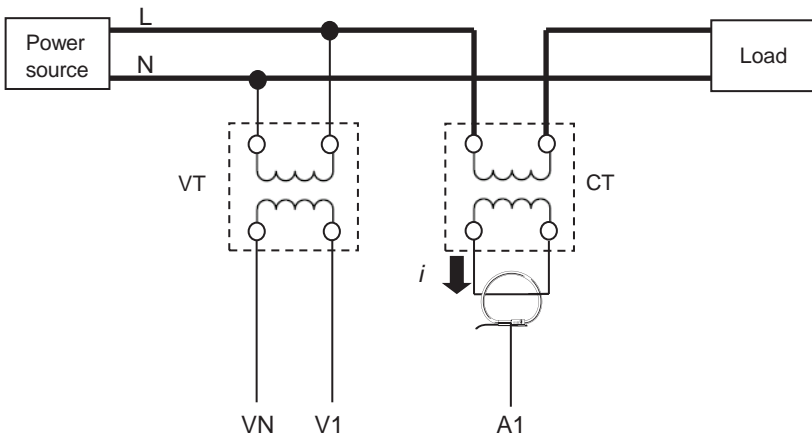



## 5. SETTINGS





### “Nominal voltage”

Set the nominal voltage values applied from the measured object.

Selection
50V - 600V(100V)

\* Default setting is highlighted in gray.

 Move the blue highlight to “Nominal V”. →  Show the value entry window.\*



→   Enter the nominal voltage value. →  Confirm.  Cancel.

\* A pop-up appears and shows the effective range.

### Default values

When the blue highlight is located at “Nominal V”, you can view a list of the popular values with the  key.

Selection
100V/ 101V/ 110V/ 120V/ 200V/ 202V/ 208V/ 220V/ 230V/ 240V/ 277V/ 346V/ 380V/ 400V/ 415V/ 480V/ 600V

 Choose the appropriate voltage. →  Confirm.  Cancel.

### Current Measurement Settings

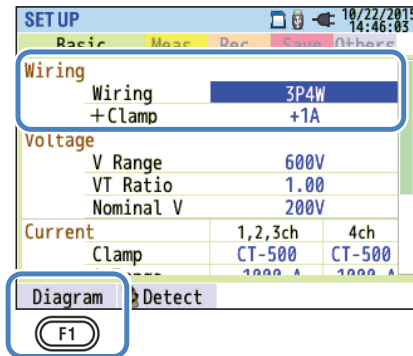

## 5. SETTINGS

### “Clamp” : Clamp sensors for current measurement

Select the model names of the connected sensors. If an optional sensor is used and set for “+ Clamp”, an exceptional sensor can be set for 4ch. The rated current and the max conductor size are displayed in a pop-up while opening the list of sensor model names.

Selection	
CT-500: 100 / 1000A / AUTO CT-53: 300 / 1000 / 3000A	Clamp sensors for power measurement

\* Default setting is highlighted in gray.

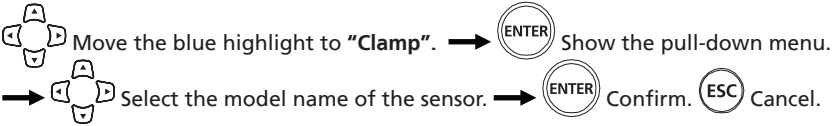

### “Current range”

Choose a desired current range. “AUTO”\* is not selectable while “Record” is set at the “Recording Tab” to record power quality events. To enable auto-ranging at current range, select “Do not record” for “Event” in the REC Item. Please refer to “VT/ CT” in this manual for the detailed settings for power quality events.

\* Measurements according to IEC61000-4-30 Class S cannot be performed while “AUTO” is selected.



## 5. SETTINGS

### “CT Ratio”

Set the proper CT ratio when CTs (current transformer) are installed in the measured system. The selected CT ratio will be reflected to all the values measured during any current measurements. The details about CT are described in “VT/CT”.

Selection
0.01 - 9999.99(1.00)

\* Default setting is highlighted in gray.

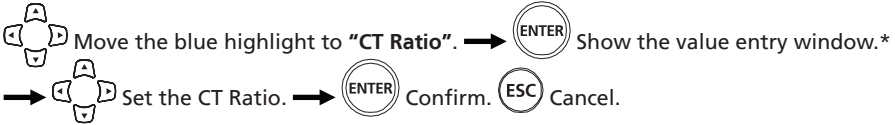

\* A pop-up appears and shows the effective range.

### Sensor detection

Pressing the key detects and displays the model names of the connected sensors automatically. However, if the connected sensors are not the ones that should be connected for the selected wiring system, or sensor detection fails, an error message will appear and the values entered at “Clamp”, “A Range” and “CT Ratio” will be cleared. The details about “Sensor detection” are described in “Sensor detection”.

### Settings of External Input Terminal/ Reference Frequency

Basic	Meas.	Rec.	Save	Others
VI ratio			1.00	
Nominal V			100V	
Current		1,2,3ch		4ch
Clamp		CT-500		CT-500
A Range		500.0 A		500.0 A
CT Ratio		1.00		1.00
DC				
DC Range			1000mV	
Frequency				
Nominal f			50Hz	

Detect

### “DC Range”

Select a proper DC range according to the incoming DC voltage signals.

Selection
100mV/ 1000mV/ 10V

\* Default setting is highlighted in gray.





## 5. SETTINGS



### “Frequency”

Choose the nominal frequency of the system to be measured. If it is difficult to specify the voltage frequency, for example, in the event of power interruption, the DM-5 performs measurements based on the preset nominal frequency.

Selection
50Hz/ 60Hz

\* Default setting is highlighted in gray.

 Move the blue highlight to “Nominal f”. →  Show the value entry window.\*

→  Choose the frequency. →  Confirm.  Cancel.

### 5.3 Measurement Setting

Press the  Key. →  Change the tabs to “Measurement”.

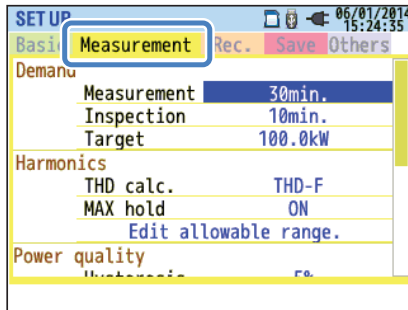

### Demand Measurement Settings

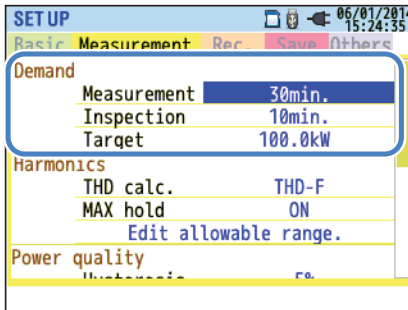

## 5. SETTINGS

### “Measurement cycle”

Disable the demand measurement or set the demand measurement cycle in the preset recording period. When a demand measurement starts, the measured demand values will be recorded at the selected measurement cycle. The cycle time should be selected from the following.



Selection
Not be used./ 10 min/ 15 min/ <b>30 min</b>

\* Default setting is highlighted in gray.

The selected demand measurement cycle has an influence on measurement intervals. Since the measurement interval cannot be set to a longer time than the demand interval, the preset measurement interval may be changed automatically according to the selected demand measurement cycle.

Selectable measurement intervals: 1sec/ 2sec/ 5sec/ 10sec/ 15sec/ 20sec/ 30sec/ 1 min/ 2 min/ 5 min/ 10 min/ 15 min/ 30 min.

 Move the blue highlight to “Measurement”. →  Show the pull-down menu.



→  Select a desired demand cycle. →  Confirm.  Cancel.



### “Target value”

Set the demand target value.

Selection
0.001mW - 999.9TW( <b>100.0kW</b> )







\* Default setting is highlighted in gray.

 Move the blue highlight to “Target”. →  Show the value entry window.\*

→  Set the CT Ratio. →  Confirm.  Cancel.

\* A pop-up appears and shows the effective range.

Either active or apparent power can be set as a demand target value. Pressing the  “VA”/ “W”

key while opening the value entry window can switch active and apparent power. Move the blue highlight with the   keys to the unit and alter the unit with   keys. Moving the decimal point is possible by pressing  or .

\* Unit for apparent power: mVA, VA, kVA, MVA, GVA, TVA / for active power: mW, \_W, kW, MW, GW, TW

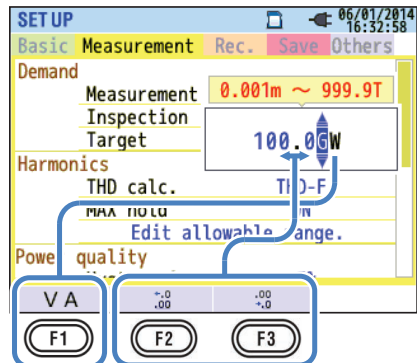

## 5. SETTINGS

### “Inspection cycle”

The buzzer sounds when the predicted value exceeds the target value within the selected inspection cycle. The inspection cycle should be shorter than the demand measurement cycle. The relations between the measurement and inspection cycles are as follows.

Selection	Inspection cycle
10 min/ 15 min	1 min/ 2 min/ 5 min
30 min	1 min/ 2 min/ 5 min/ 10 min/ 15 min

\* Default setting is highlighted in **gray**.

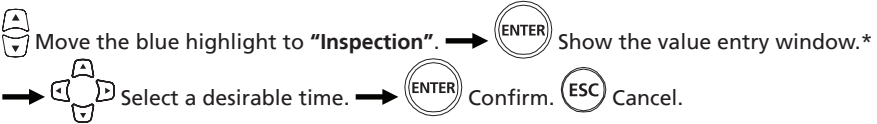

\* A pop-up appears and shows the effective range.

### Outline of Demand Measurement Concept

The maximum demand is the maximum of average powers recorded over a 30 min interval. Assuming the max target demand to be 500kW, the average power during measurement cycle 1 is fine, but the power consumption for the first 15 min of measurement cycle 2 is 600kW. In such a case, the average power during measurement cycle can be maintained at 500kW (same as measurement cycle 1) by reducing the power of the last 15 min to 400kW. If the power consumption during the first half of cycle 2 is 1000kW and the last 15min is 0kW, the average power is the same: 500kW. While “Inspection cycle” is set to “15 min”, the buzzer sounds after 15 min at the start of measurement cycle 2.

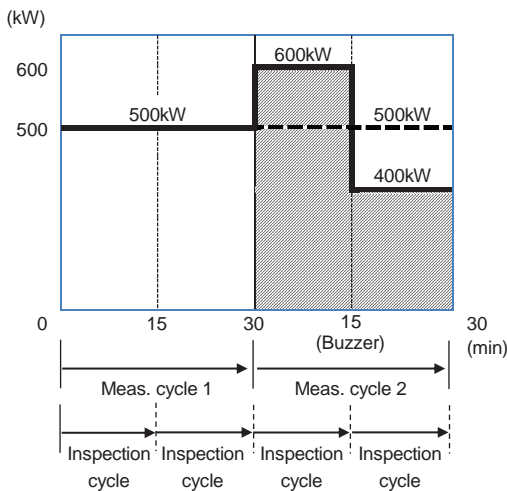

Harmonic Analysis Settings

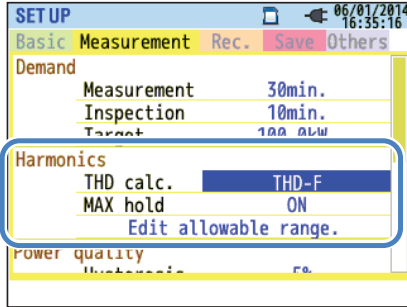

“THD calculation”

THD stands for “Total Harmonic Distortion”. Select “THD-F” to calculate the total harmonics distortion based on the basic wave and “THD-R” to do the calculation based on all rms values.

Selection
THD-F (based on basic wave)/ THD-R (based on all rms values)

\* Default setting is highlighted in gray.

- Move the blue highlight to “THD calc.”. → Show the pull-down menu.
- Select the calculation method. → Confirm. Cancel.

“MAX hold”

Turn on the MAX hold to show an indication of the max rate on a harmonics graph.

Selection
ON/ OFF

\* Default setting is highlighted in gray.

- Move the blue highlight to “MAX hold”. → Show the pull-down menu.
- Turn on/ off. → Confirm. Cancel.



## 5. SETTINGS

### “Edit allowable range”

Set the EMC allowable range (rate of content) for harmonics per order. The edited ranges are displayed as a bar graph on the graph of harmonics.

Selection
Default/ can be customized (V/ A)

\* Default setting is highlighted in gray.

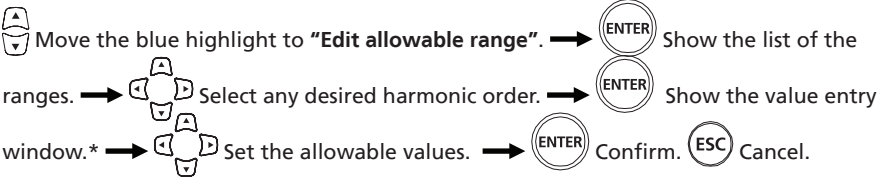

\* A pop-up appears and shows the effective range.

The values in each box by default comply with the international EMC standard IEC61000-4-7:

Industrial environment Class 3. Press the **F3** key (Default) to restore the edited values to default.

Press the **F2** key (A/V [%]) to switch current and voltage. The **F1** key is to return to the measurement settings screen.

SETUP																																																											
Harmonics allowable range:																																																	V rate[%]										
1:	2:	3:	4:	5:	6:	7:	8:	9:	10:	11:	12:	13:	14:	15:	16:	17:	18:	19:	20:	21:	22:	23:	24:	25:	26:	27:	28:	29:	30:	31:	32:	33:	34:	35:	36:	37:	38:	39:	40:	41:	42:	43:	44:	45:	46:	47:	48:	49:	50:										
100.0	3.0	6.0	1.5	8.0	1.0	7.0	1.0	2.5	1.0	5.0	1.0	4.5	1.0	2.0	1.0	4.0	1.0	3.5	1.0	1.8	1.0	2.8	1.0	2.6	1.0	1.0	1.0	2.1	1.0	3.1	3.2	3.3	3.4	3.5	3.6	3.7	3.8	3.9	4.0	2.0	1.0	1.0	1.0	1.7	1.0	1.6	1.0	1.0	1.0	1.1	1.1	1.1	1.1	1.1	1.1	1.1	1.1	1.1	1.1

**BACK** (F1)    **A[%]** (F2)    **Default** (F3)

### Threshold Setting for Power Quality (Event)

SETUP	
Basic Measurement Rec. Save Others	
MAX hold	ON
Edit allowable range	
Power quality	
Hysteresis	5%
Transient	300 Vpeak
SWELL	110%(110.0 V)
DIP	90%( 90.0 V)
INT	OFF
InrushCurrent#	OFF
OFF	(F1)

Press the **F1** (OFF/ ON) to disable or enable the “threshold value” entry. If “OFF” is selected, the item will not be recorded even if the threshold value is set. The threshold value used during the previous measurement is displayed by pressing the **F1** (ON) key.

## 5. SETTINGS

### ⚠ Caution:

Threshold values for "Swell", "Dip" and "INT" are the percentage of the nominal voltage. So when the nominal voltage is changed, threshold voltage will be altered accordingly. For "Transient", if the nominal voltage is changed, the initial value will be automatically set to "300%", which is three times the new nominal voltage (peak voltage). The threshold value for "Inrush current" is the percentage of the Current Range, therefore, the value will be altered if the setting of the current range is changed.

### "Hysteresis"

Set a desired hysteresis in percentage to disable the event detection for the specific area. Setting a proper hysteresis will be helpful to prevent unnecessary detections of events which are caused by voltage or current fluctuations around the threshold values.

Selection
1 - 10% against the nominal voltage (5%)

\* Default setting is highlighted in gray.

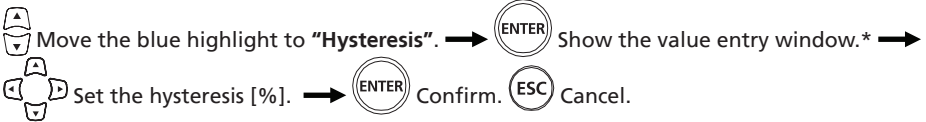

\* A pop-up appears and shows the effective range.

### "Transient": Over-voltage (Impulse)"

Set an instantaneous voltage value as a threshold for the transient event. The following selection range varies depending on the selected VT ratio.

Selection
±50 to ±2200Vpeak against the nominal voltage (300%)

\* Default setting is highlighted in gray.

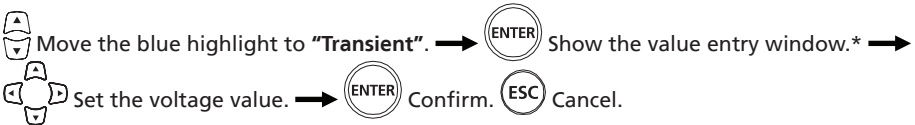

\* A pop-up appears and shows the effective range.

### Example of Transient detection:

The details are described in "Displaying recorded events".

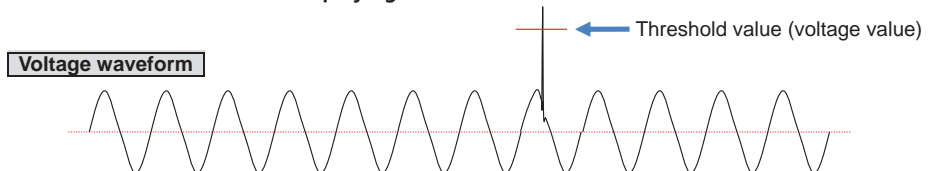

## 5. SETTINGS

### “SWELL”: Instantaneous voltage rise”

Set the threshold value (rms voltage in one cycle) for swell in percentage of the nominal voltage. The following selection range varies depending on the selected VT ratio. The preset hysteresis has an effect on this threshold value.

Selection
100 - 200% against the nominal voltage (110%)

\* Default setting is highlighted in gray.

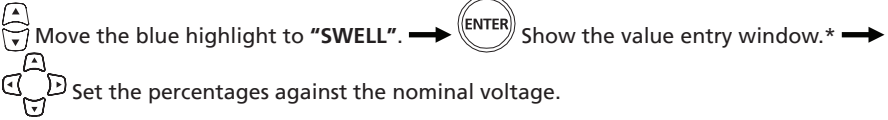

\* A pop-up appears and shows the effective range.

### “Inrush Current”: Instantaneous current rise

Set the threshold value (rms current in one cycle) for inrush current in percentage of the max value of the current range. The following selection range varies depending on the selected CT ratio. The preset hysteresis has an effect on this threshold value.

Selection
0 - 110% against the nominal voltage (100%)

\* Default setting is highlighted in gray.

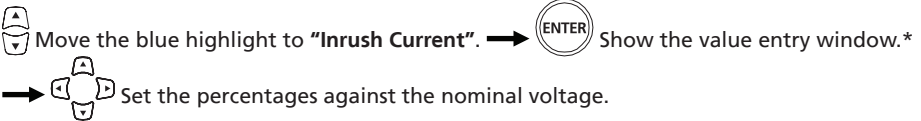

Example of Swell/ Inrush current detection:

The details are described in “Displaying recorded events”.

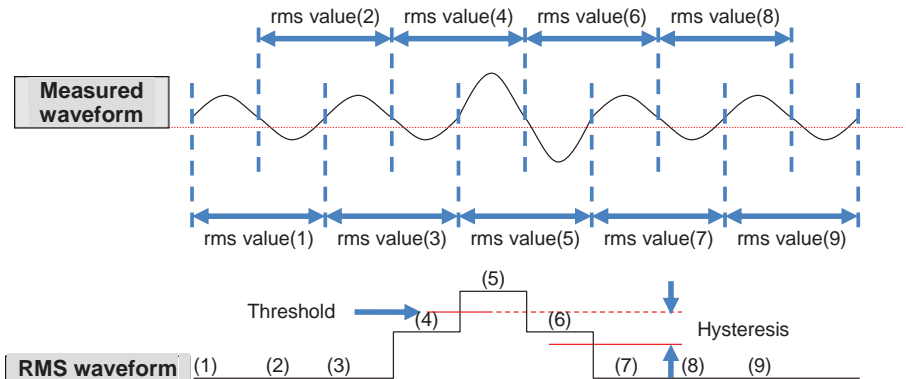



## 5. SETTINGS

### “DIP”: Instantaneous voltage drop

Set the threshold value (rms voltage in one cycle) for dip in percentage of the nominal voltage. The following selection range varies depending on the selected VT ratio. The preset hysteresis has an effect on this threshold value.

Selection
0 - 100% against the nominal voltage (90%)

\* Default setting is highlighted in gray.

 Move the blue highlight to “DIP”. →  Show the value entry window.\*

→  Set the percentages against the nominal voltage.



\* A pop-up appears and shows the effective range.

### “INT”: A short period of power interruption

Set the threshold value (rms voltage in one cycle) for INT in percentage of the nominal voltage. The following selection range varies depending the preset VT ratio. The preset hysteresis has an effect on this threshold value. If rms voltages, 10V or less, are used for event detections, ensure that the Int event detection is enabled. Otherwise, events will not be detected properly.

Selection
0 - 100% against the nominal voltage (10%)

\* Default setting is highlighted in gray.

 Move the blue highlight to “INT”. →  Show the value entry window.\*

→  Set the percentages against the nominal voltage.

Example of Dip/ Int detection:

The details are described in “Displaying recorded events”.

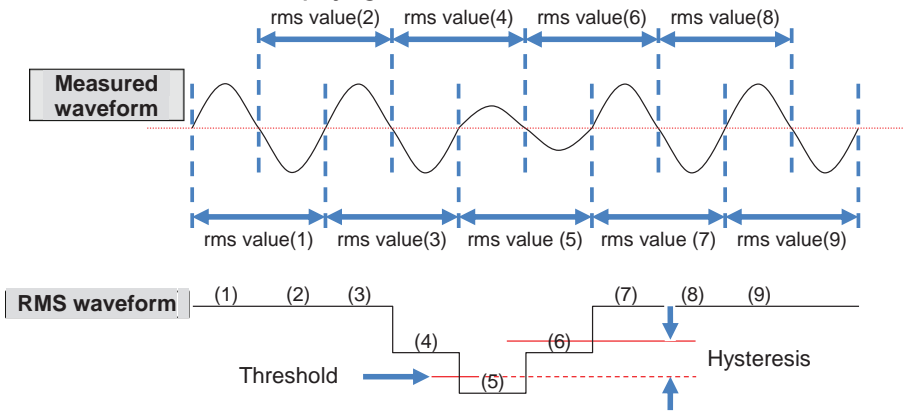

Filter Setting for Flicker Measurement

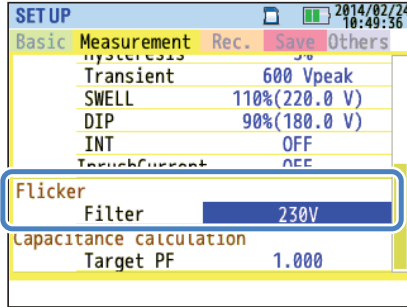

“Filter coefficient”

Set a proper filter coefficient according to the nominal voltage for accurate flicker measurements. Select the values of nominal voltage, nominal frequency and filter coefficient values appropriate to the actual measured object. If possible, harmonize the filter coefficient and the nominal voltage.

Selection
230V/ 220V/ 120V/ 100V

\* Default setting is highlighted in gray.

- Move the blue highlight to “Filter”. → Show the pull-down menu.
- Select proper Filter coefficient. → Confirm. Cancel.

Target Power Factor for Capacitance Calculation

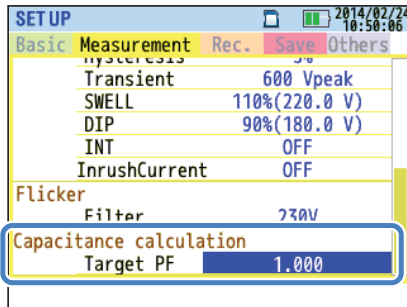



## 5. SETTINGS



### “Target power factor”

Set a target power factor for capacitance calculation. The power factor is negatively influenced if inductive loads, such as motors, that are connected to the power supply because current phases lag behind the voltage phases in this case. Usually, phase advanced capacitors are installed in high-voltage-receiving installations, to reduce such influences. Improving the power factor may cut down electricity tariffs if the customer is on low-, high- or industrial power construction.

Selection
0.5 – 1 (1.000)

\* Default setting is highlighted in gray.

 Move the blue highlight to “Target PF”. →  Show the value entry window.\*

→   Select a desired target PF.

\* A pop-up appears and shows the effective range.

### 5.4 Recording Setting

Press the  Key. →  Change the tabs to “Recording”.

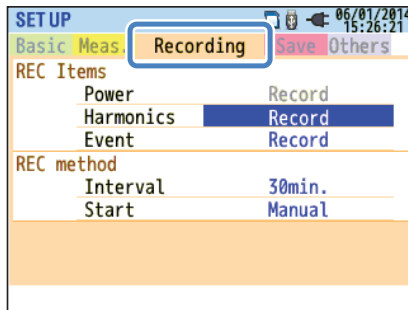

The screenshot shows a menu titled "SET UP" with a date and time display (06/01/2014 15:26:21). The menu has four tabs: "Basic", "Meas.", "Recording", and "Save Others". The "Recording" tab is selected and highlighted with a blue border. Below the tabs, there are two sections: "REC Items" and "REC method".

REC Items	
Power	Record
Harmonics	Record
Event	Record

  

REC method	
Interval	30min.
Start	Manual

## 5. SETTINGS

### Settings for Recording Items

The possible recording time on SD cards or the internal memory varies depending on the number of the recorded items and the preset intervals. Select "Do not record" for the items which are not necessary to record to secure a longer recording time. The details are described in "Possible recording time"

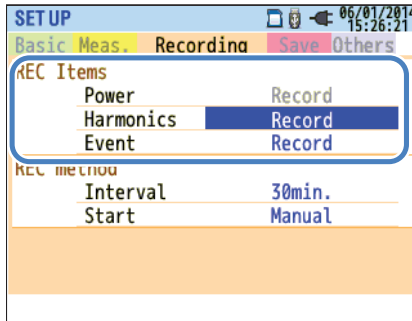

#### "Power"

The blue highlight cannot be located on this area. This is to ensure that all the items related to electric power are always recorded.

#### "Harmonics"

Select "Record" or "Do not record" the harmonics of voltage, current and power.

Selection
Record/ Do not record

\* Default setting is highlighted in gray.

#### "Event"

Select "Record" or "Do not record" the detailed data when power quality events occur. The "Do not record" is not selectable when "AUTO"\* is set for "A Range". To select "Record", set it to any other proper current ranges other than "AUTO".

\* Measurements complied with IEC61000-4-30 Class S cannot be performed with "AUTO" setting.

Selection
Record/ Do not record

\* Default setting is highlighted in gray.

 Move the blue highlight to "Harmonics"/ "Event". →  Show the pull-down menu.

→  Select "Record" or "Do not record". →  Confirm.  Cancel.

## 5. SETTINGS

### Saved Items

The following data measured on each CH will be saved according to the selected recording method. Saved items are dependent on the selected recording method and wiring system.

REC file	REC item	Meas./ Rec. setting		
		Power	+Harmonics	+Event
Power measurement	RMS voltage (line/ phase)			
	RMS current			
	Active power			
	Reactive power			
	Apparent power			
	Power factor			
	Frequency			
	Neutral current(3P4W)			
	V/ A phase angle (1st order)			
	Analog input voltage, 1CH, 2CH			
	V/A unbalance ratio			
	1-min Voltage flicker			
	Short-term V Flicker (Pst)	■	■	■
	Long-term V Flicker (Plt)			
	Capacitance calculation			
	Active power energy (consumption/ regenerating)			
	Reactive power (consumption) lagging/ leading			
	Apparent power energy (consumption/ regenerating)			
	Reactive power (regenerating) lagging/ leading			
	Demand (W/VA)			
	Target demand (W/VA)			
Total harmonic distortion of V(F/R)				
Total harmonic distortion of A(F/R)				
Harmonics measurement	Harmonic V/ A(1-50th order)			
	V/ A phase angle (1-50th order)		■	
	V/ A phase difference (1-50th order)			
	Harmonic power (1-50th order)			
V/ A Change	RMS voltage per half-cycle			■
	RMS current per half-cycle			
Event type	Event detected date & time			
	Event type			■
	Measured values at event detection			
Waveform	V/A waveform			■



Recording Method

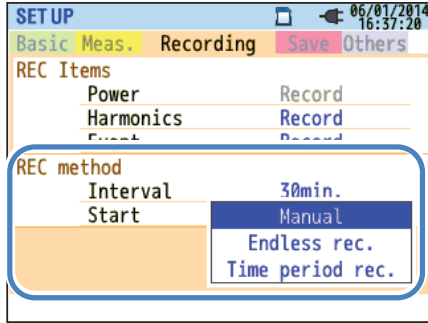

“Interval”

Set the interval to record the measured data on the SD or internal memory. Seventeen different intervals are available, but it cannot be set to a longer time than the demand measurement cycle. The preset recording interval may be changed automatically according to the selected demand measurement cycle. Please refer to “Settings of demand measurement” in this manual.

Selection
1 sec/ 2 sec/ 5 sec/ 10 sec/ 15 sec/ 20 sec/ 30 sec/ 1 min/ 2 min/ 5 min/ 10 min/ 15 min/ 20 min/ <b>30 min</b> / 1 hour/ 2 hours/ 150,180 cycles (approx. 3 sec)

\* Default setting is highlighted in gray.

\* The intervals: 150, 180 cycles (approx. 3 sec) are the ones defined in IEC61000-4-30. Data will be collected in 150 cycles at 50Hz (nominal frequency) and in 180 cycles at 60Hz (nominal frequency).

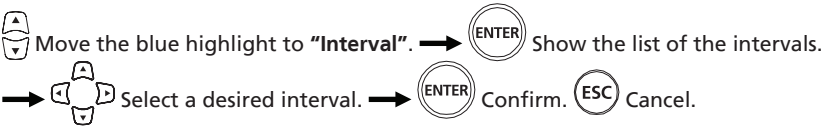

“Start”

Select the method to start recording.

Selection
<b>Manual</b> / Constant rec./ Time period rec.

\* Default setting is highlighted in gray.

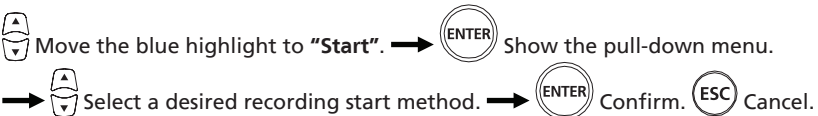

“Manual”





Start/ stop the recording with  Key.

## 5. SETTINGS

### “Constant recording”

Measured data will be recorded continuously at the preset interval during the specified start/ stop time and date. Please refer to “(8)/ (9) Setting for recording method”.











Selection	Selection
Start time and date	Day/ Month/ Year Hour:Minute (00/00/0000 00:00)
Stop time and date	Day/ Month/ Year Hour:Minute (00/00/0000 00:00)

 Move the blue highlight to “REC Start”/ “REC End”. →  Show the value entry window. →  Specify the time and date. →  Confirm.  Cancel.

### “Time period recording”

Measured data will be recorded at the preset interval for the specified time period of the selected period. When the specified time comes, a recording will start and end automatically; such a recording cycle will be repeated everyday during the specified period. Please refer to “(8)/ (9) Setting for recording method”.

	Selection
REC Period Start-Stop	Day/ Month/ Year (DD/ MM/ YYYY) - Day/ Month/ Year (DD/ MM/ YYYY)
REC Time Start-Stop	Hour:Minute (hh:mm) - Hour:Minute(hh:mm)

 Move the blue highlight to “REC Period”. →  Show the value entry window. →  Specify the time and date. →  Confirm.  Cancel. →  Move the blue highlight to “REC Time”. →  Show the value entry window. →  Specify the time and date. →  Confirm.  Cancel.

### Possible Recording Time

When a 2GB SD is used:

Interval	REC item		Interval	REC item	
	Power	+Harmonics		Power	+Harmonics
1 sec	13 days	3 days	1 min	1 year or more	3 months
2 sec	15 days	3 days	2 min	2 years or more	6 months
5 sec	38 days	7 days	5 min	6 years or more	1 years or more
10 sec	2.5 months	15 days	10 min	10 years or more	2 years or more
15 sec	3.5 months	23 days	15 min		3 years or more
20 sec	5 months	1 month	20 min		5 years or more
30 sec	7.5 months	1.5 months	30 min		7 years or more
			1 hour		10 years or more
			2 hours	more	
			150/180-cycle	23 days	4 days

## 5. SETTINGS

\* Possible recording time does not account for data from power quality events. The max possible recording time will be shortened by recording such events. The max file size per recording is 1GB.

\* For best performance, use only the SD cards provided with this instrument or as optional parts.

### 5.5 Other Settings

Press the **SET UP** Key. →  Change the tabs to "Others".

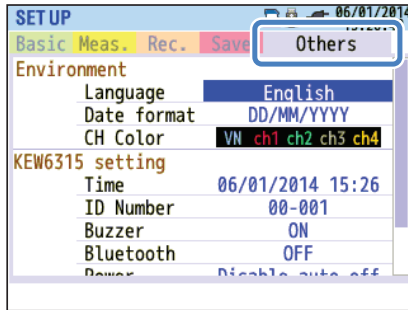

### Settings for System Environment

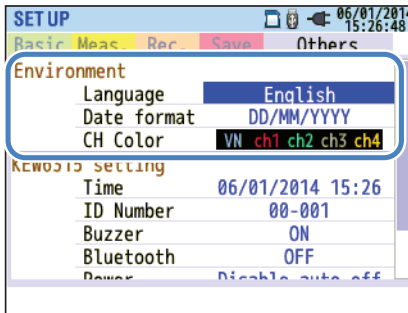





### "Language"

Select the language to be displayed.



\* Default setting is highlighted in gray. Changes made by user will remain after system reset.

 Move the blue highlight to "Language". →  Show the pull-down menu.

→  Select a desired language. →  Confirm.  Cancel.





## 5. SETTINGS

### “Date format”

Select a desired date display format. The selected date format will be reflected to the date display on the screen and on each setting window.



\* Default setting is highlighted in gray. Changes made by user will not be cleared after system reset.

-  Move the blue highlight to “Date format”. →  Show the pull-down menu.
-  Select a desired date format. →  Confirm.  Cancel.

### “CH color”

Specify the colors for voltage and current per CH. The colors will be reflected on item labels and lines on the graph and wiring diagram.

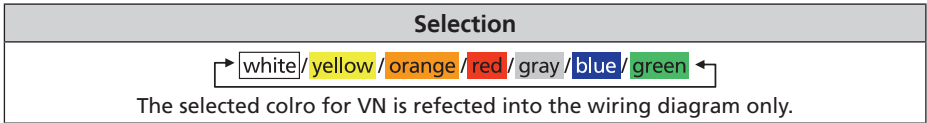

The selected color for VN is reflected into the wiring diagram only.

\* Default color setting is: VN: Yellow/ 1CH: Red/ 2CH: White/ 3CH: Blue/ 4CH: Green. Changes done by user will not be restored to default even after the system is reset.

-  Move the blue highlight to “CH Color”. →  Show the color setting window.
-  Select colors. →  Confirm.  Cancel.

### DM-5 Setting

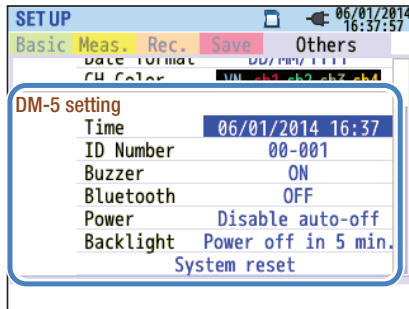

## 5. SETTINGS

### “Time”

Adjust and set the internal system clock.

Selection
dd/ mm/ yyyy hh:mm

\* The selected date format has an effect on this setting.

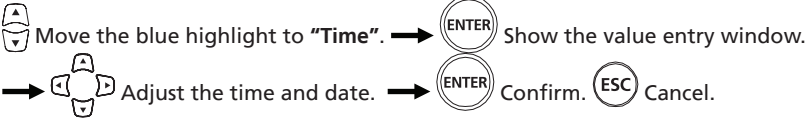

### “ID Number”

Assign an ID number for the unit. Assigning ID numbers will be helpful in analyzing recorded data when multiple units are used at the same time or when periodically measuring multiple systems with one unit.

Selection
00-001 to 99-999 (00-001)

\* Default setting is highlighted in **gray**.

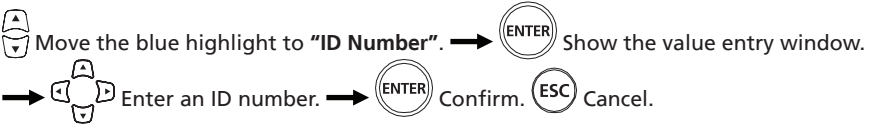

### “Buzzer”

Keypad sounds can be muted. The warning buzzer for demand judgment or low battery voltage sounds even when “OFF” is selected.

Selection
On/ Off

\* Default setting is highlighted in **gray**.

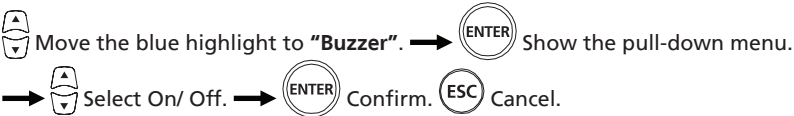

### “Connecting with a Bluetooth® Enabled Device”

Turn on/ off the Bluetooth® function. Select “Off” if connectivity with a Bluetooth® enabled device will not be performed.

Selection
On/ Off

\* Default setting is highlighted in **gray**.

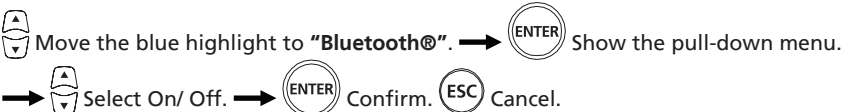

## 5. SETTINGS

### “Power”

Select to enable or disable the auto-power-off function. This setting is for situations when the DM-5 operates from an AC power supply. Auto-power-off activates in 5 min after the last operation while DM-5 is operating from Battery power.

For:	Selection
AC Power	Power off in 5 min. / <b>Disable auto-off</b>
Battery	Power off in 5 min.

\* Default setting is highlighted in **gray**.





-  Move the blue highlight to “Power”. →  Show the pull-down menu.
-  Select either turning on/ off the auto-off function. →  Confirm.  Cancel.

### “Backlight”

This setting can turn off the backlight automatically when the prescribed time passes after the last key operation. The backlight will be turned off 2 min after the last operation while DM-5 is operating from battery power.





For:	Selection
AC Power	<b>Power off in 5 min.</b> / Disable auto-off
Battery	Power off in 2 min.

\* Default setting is highlighted in **gray**.

-  Move the blue highlight to “Backlight”. →  Show the pull-down menu.
-  Select either turning on/ off the auto-off function. →  Confirm.  Cancel.

### “System reset”

Restore all the settings to default except for “Language”, “Date format”, “CH Color” and “Time”.





-  Move the blue highlight to “System reset”. →  Show a confirmation message.
-   Select “Yes” or “No”. →  Restore the settings to default.

## 5. SETTINGS

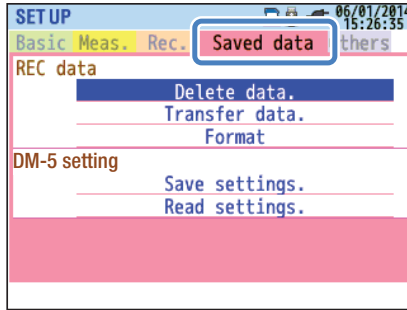

### 5.6 Saved Data

Press the **SET UP** Key. →   Change the tabs to "Saved data".



Save the "  ": Measurement data, "  ": Print screen" and "  ": Setting data" on the "  "SD card or in the "  " internal memory. If SD card is inserted in the instrument, these data will be automatically saved on the SD card. Remove or do not insert the SD card to save the data in the internal memory. Data save destination is not adjustable. Max number of the file that can be saved in the internal memory is 3 for measurement data and 8 for the other data.

### To Delete, Transfer or Format the Recorded Data



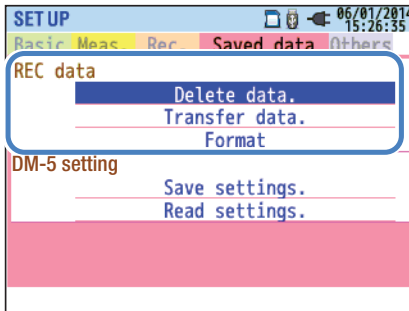

 Select a desired language. →  Confirm.



## 5. SETTINGS





### “Delete data”

Show the list of the recorded data, and then select unwanted data.

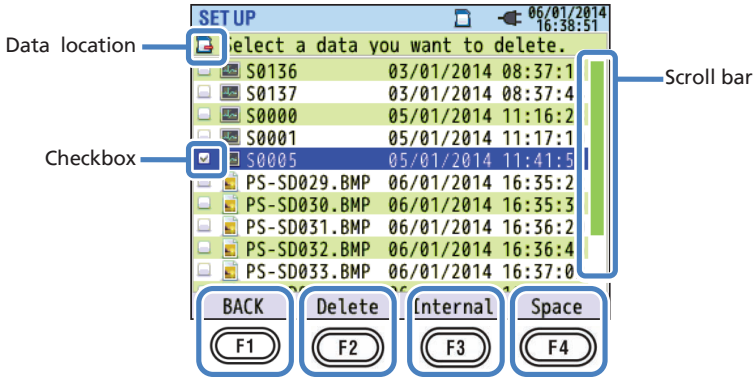
Icons on the screen means: : SD card, : Internal memory,  Measured data, : Print screen, : Setting data

Data are not listed in time sequence. The recorded date and time are displayed to the right of file name. As for the data which are previously transferred from the internal memory to an SD card, the displayed time means when the data were transferred. The scroll bar is displayed when the list of the recorded data exceeds the display area.



-  Move the blue highlight to the data you want to delete. →  Confirm.
-  A confirmation message will appear. →  Select “Yes” or “No”.
-  Delete the data.

A check mark “” will be put in the checkbox for the selected data. Multiple data can be selected at once.

### “Delete”

Press the  Key and select “Yes” on the confirmation message to delete the data.

### “Internal”/ “SD card”

Pressing the  Key can switch between “Internal memory” and “SD Card” and the corresponding icon will be displayed in the upper left of the screen. Checked boxes will be cleared if the screens are switched before deleting the data.



## 5. SETTINGS

### “Space”

Storage media information can be checked with the **F4** Key. Press the **ENTER** Key to close the information window.

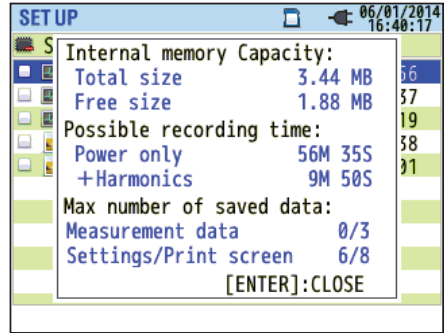
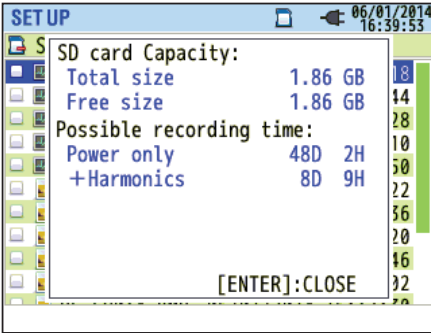





Displayed items		Selection
Capacity	Total size	Total memory capacity
	Free size	Capacity of free space
Possible recording time	Power only	Estimated possible recording time if the parameters to be recorded are limited to power-related ones only.
	Power+ Harmonics	Estimated possible recording time if the parameters to be recorded are power-related ones and harmonics.
Max number of saved data * Internal memory only	Measurement data	Number of measurement data files saved in the memory * Max number of files: 3
	Settings / Print screen	Number of DM-5 setting and print screen data files * Max number of files: 8

### “BACK”

To return to the “Saved data” screen, press the **F1** Key.



## 5. SETTINGS

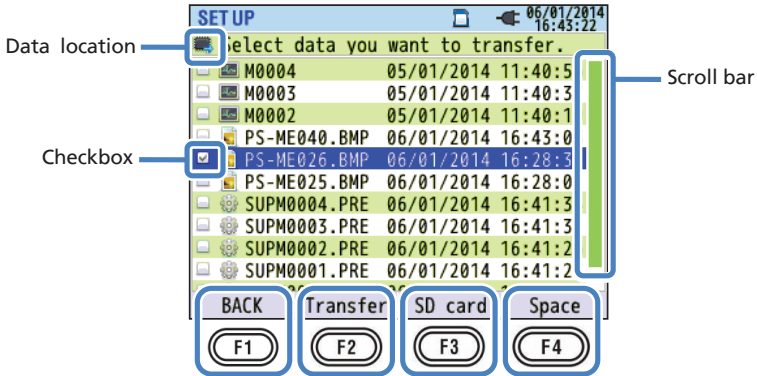

### “Transfer data”

Select the data you want to transfer from the “”: internal memory to the SD card “”. Data files which can be transferred are: “”: Measurement data, “”: Print screen, “”: Setting data. Data are not listed in time sequence. The recorded date and time are displayed to the right of file name.

As for the data which are previously transferred from the internal memory to an SD card, the displayed time means when the data were transferred. The scroll bar is displayed when the list of the recorded data exceeds the display area.



 Select the data you want to transfer. →  Confirm.

→  A confirmation message will appear. →  Select “Yes” or “No”.



→  Selected data will be transferred.

A check mark “” will be put in the checkbox for the selected data. Multiple data can be selected at once.



### “Transfer”

Press the  (Transfer) Key and select “Yes” on the confirmation message to transfer the selected data.

### “SD card”

To check the data on the SD card, press the  (SD card) Key. Pressing the  Key again returns to the list of data saved in the internal memory. Checked boxes will be cleared if the screens are switched before transferring the data.

### “Space”



Storage media information can be checked with the  Key. Press the  Key to close the information window. Please refer to “Space” for further details.

### “BACK”

To return to the “Saved data” screen, press the  Key.

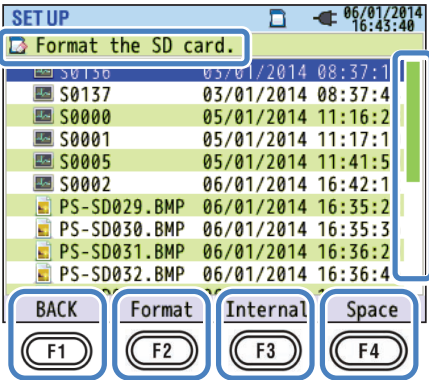

## 5. SETTINGS

### “Format”

Format the “

The screenshot shows the 'SETUP' screen with a title bar at the top right displaying '06/01/2014 16:43:40'. Below the title bar, the text 'Format the SD card.' is highlighted. A list of files is shown with columns for file names and timestamps. A vertical scroll bar is on the right side of the list. At the bottom, there are four buttons: 'BACK' (F1), 'Format' (F2), 'Internal' (F3), and 'Space' (F4). Labels 'Data location' and 'Scroll bar' point to the 'Format the SD card.' text and the scroll bar respectively.

File Name	Date/Time
S0130	03/01/2014 08:37:1
S0137	03/01/2014 08:37:4
S0000	05/01/2014 11:16:2
S0001	05/01/2014 11:17:1
S0005	05/01/2014 11:41:5
S0002	06/01/2014 16:42:1
PS-SD029.BMP	06/01/2014 16:35:2
PS-SD030.BMP	06/01/2014 16:35:3
PS-SD031.BMP	06/01/2014 16:36:2
PS-SD032.BMP	06/01/2014 16:36:4

**F2** A confirmation message will appear. →   Select “Yes” or “No”.

→  Format.

### “Format”

A confirmation message will appear when pressing the **F2** (Format) Key. Select “Yes” to start format.

### “Internal”/ “SD card”

Pressing the **F3** Key can switch between “Internal memory” and “SD Card” and the corresponding icon will be displayed in the upper left of the screen.

### “Space”

Storage media information can be checked with the **F4** Key. Press the  Key to close the information window. Please refer to “Space” for further details.

### “BACK”

To return to the “Saved data” screen, press the **F1** Key.

## 5. SETTINGS

### Data file handling

The file name will be assigned automatically. File number is kept and saved, even after powering off the instrument, until the system is reset. The file number will increase until it exceeds the max file number.

If a file with the same file name already exists, the files in the data folder will be saved as another name with a different file number. The file number will be automatically increased by 1. However, "Print screen" and "Setting" files will be overwritten in such a case. When the file number starts from "0" or the same SD is used for multiple instruments, extra precautions should be paid so that necessary files will not be overwritten. When all the file numbers are used for each type of data, the files on the data folder will be overwritten.

If files are deleted or the name of a folder or file are changed on a PC, editing on the instrument or data analysis with special software cannot be performed. Do not change the name of folder or file.

### "Print screen"

Press the  to save the screen images as BMP files.

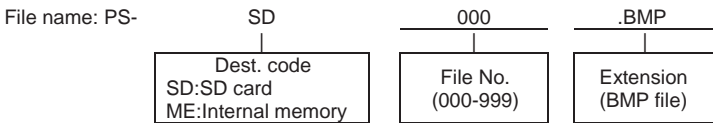

\* Dest. = Destination

### "DM-5 Setting"

Press the  key and move to "Saved data" tab, and then select "Save Settings".

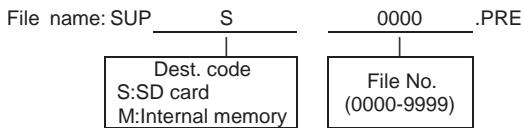

### "Data folder"

New folder will be created per measurement to save the interval and power quality data.

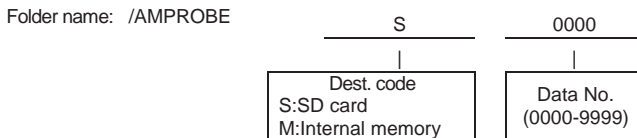

]

## 5. SETTINGS

---

### “Interval data”

DM-5 setting	File name	SUP	S	0000	.AMP
Measurement setting		INI	S	0000	.AMP
Power measurement		INP	S	0000	.AMP
Harmonics measurement		INH	S	0000	.AMP

|

Dest. code SD:SD card M:Internal memory
---

|

Data No. (0000-9999)
-------------------------

### “Power quality data”

Event type	File name	EVT	S	0000	.AMP
Waveform		WAV	S	0000	.AMP
V/ A change		VAL	S	0000	.AMP



|

Dest. code S:SD card M:Internal memory
--

|



Data No. (0000-9999)
-------------------------

DM-5 Settings and Data Loading

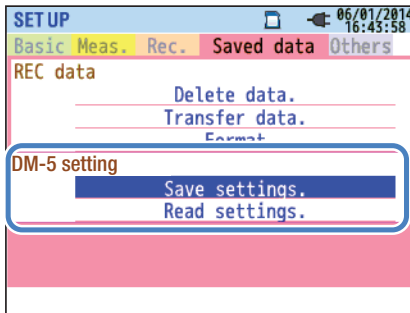

 Select a desired language. →  Confirm.

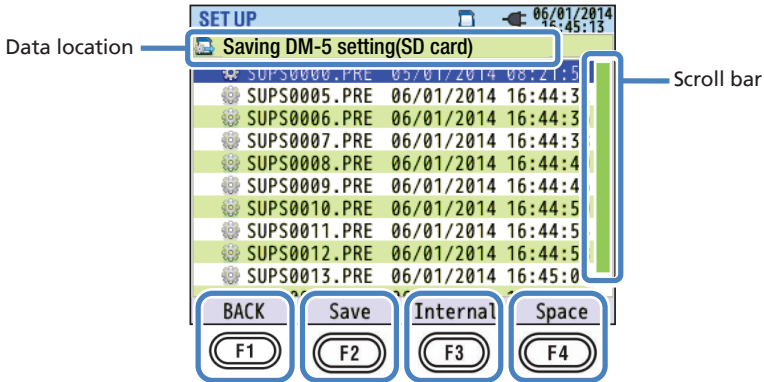

“Save settings”

Save the “”: Setting data on the “”: SD card or in the “”: internal memory. Data are not listed in time sequence. The recorded date and time are displayed to the right of file name. As for the data which were previously transferred from the internal memory to an SD card, the displayed time means when the data were transferred. The scroll bar is displayed when the list of the recorded data exceeds the display area.



 A confirmation message will appear. →  Select “Yes” or “No”.

→  Data will be saved.

“Save”

Press the  Key and select “Yes” on the confirmation message to save the data on the SD card or in the internal memory.

“Internal”/ “SD card”

Pressing the  Key can switch between “Internal memory” and “SD Card” and the corresponding icon will be displayed in the upper left of the screen.

## 5. SETTINGS

### “Space”

Storage media information can be checked with the **F4** Key. Press the **ENTER** Key to close the information window. Please refer to “Space” for further details.

### “BACK”

To return to the “Saved data” screen, press the **F1** Key.

The following settings for DM-5 can be saved.

#### Basic setting

Setting item
Wiring
Voltage range
VT ratio
Nominal voltage
Clamp/ Current range
CT ratio
DC range
Frequency

#### Other settings

Setting item	
Environment	Date format
DM-5 setting	ID number
	Buzzer

#### Measurement setting



Setting item	
Demand	Measurement cycle
	Inspection cycle
	Target
Harmonics	THD(total harmonic distortion) calc.
	Allowable range
	MAX HOLD
Power quality	Threshold for Hysteresis
	Threshold for Transient
	Threshold for Swell
	Threshold for Dip
	Threshold for INT
	Threshold for Inrush current
Flicker	Filter coefficient (Ramp)
Capacitance calculation	Target PF

#### Recording setting



Setting item	
Recording item	Harmonics
	Power quality (event)
Recording method	Interval
	Start
Constant meas.	REC Start
	REC End
Time period rec.	Rec. period Start – End
	Time period Start – End

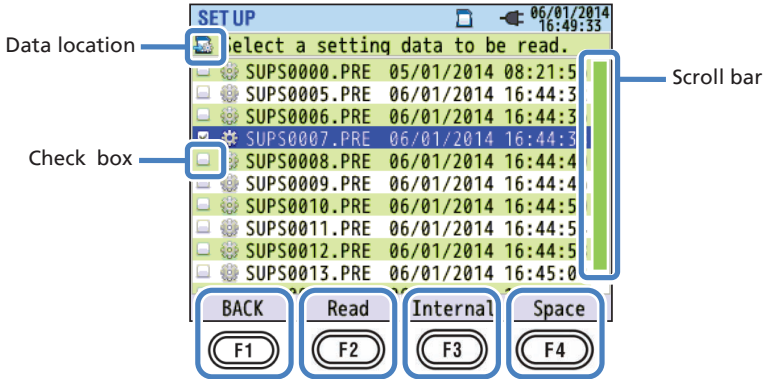

## 5. SETTINGS

### “Read settings”

Read the “”: Setting data from the “”: SD card or from the “”: internal memory. Data are not listed in time sequence. The recorded date and time are displayed to the right of file name. As for the data which were previously transferred from the internal memory to an SD card, the displayed time means when the data were transferred. The scroll bar is displayed when the list of the recorded data exceeds the display area.



 Select the data you want to transfer. →  Confirm.

→  A confirmation message will appear. →  Select “Yes” or “No”.

→  Confirm.

The scroll bar is displayed when the list of the recorded data exceeds the display area. A check mark “” will be put in the checkbox for the selected data.



### “Read”

Press the  (Transfer) Key and select “Yes” on the confirmation message to transfer the selected data.

### “Internal”/ “SD card”

Pressing the  Key can switch between “Internal memory” and “SD Card” and the corresponding icon will be displayed in the upper left of the screen.

### “Space”

Storage media information can be checked with the  Key. Press the  Key to close the information window. Please refer to “Space” for further details.

### “BACK”

To return to the “Saved data” screen, press the  Key.



## 6. DISPLAYED ITEMS

### 6.1 Instantaneous value "W"

Press the **(W/Wh)** Key. → **(F1)** Display the screen for "W": Instantaneous value.

#### List Display of the Measured Values

**(F2)** "List" (/Zoom)

e.g.) Instantaneous values measured under 3P3W3A+1A (Three-phase Three-wire + Current (optional sensor))

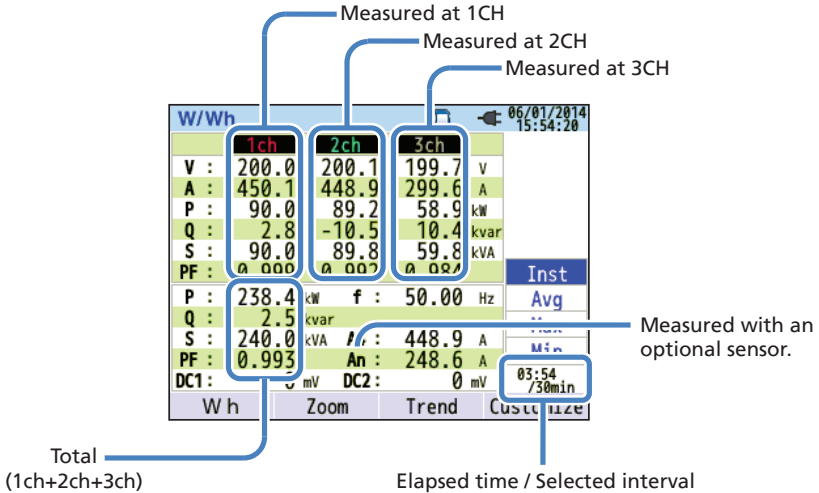

Multiple measured values can be displayed on one screen. The displayed items can be changed by pressing the corresponding keys.

V*1	Phase voltage	VL*1	Line voltage	A	Current
P	Active + consumption power - regenerating	Q	Reactive + lagging power - leading	S	Apparent power
PF	Power + lagging factor - leading	f	Frequency		
DC1	Analog input voltage at 1ch	DC2	Analog input voltage at 2ch		
An*2	Neutral current	PA*3	Phase + lagging angle - leading	C*3	Capacitance calculation

\*1 W screen: Displays of V and VL can be "customized" when "3P4W" is selected.

\*2 W screen: "An" is displayed only when "3P4W" is selected.

\*3 W screen: Displays of PA and C can be "customized" with the (customize) Key. Line voltages are converted into phase voltages to determine currents and phase angles for "PA" of 3P3W3A.

## 6. DISPLAYED ITEMS

e.g.) Instantaneous values measured under 1P3W-2 (2 systems)

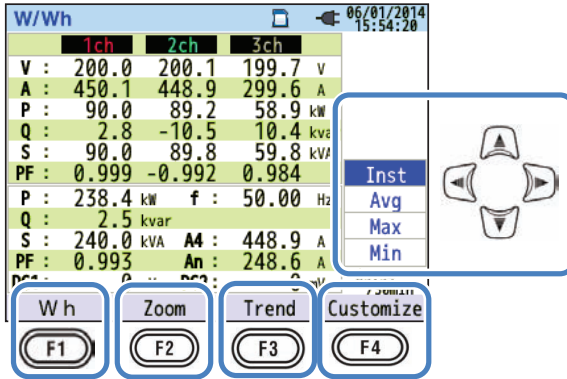

### “Switching the Displayed Systems”

Press the  key and switch the displayed systems. Items displayed in a screen depend on the selected wiring configuration and the number of systems. **The dotted lines represent the space of each display area.**

#### 1P2W-1 to -4 (Single phase, 2-wire, 1 – 4 systems)

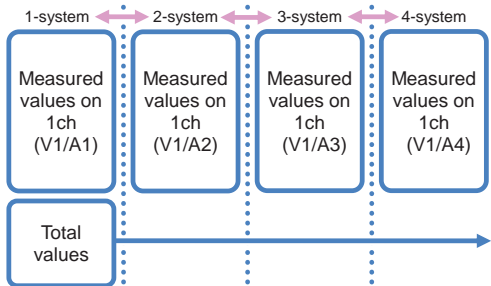

#### 1P3W-1, -2 (Single phase, 3-wire, 1 or 2 systems)

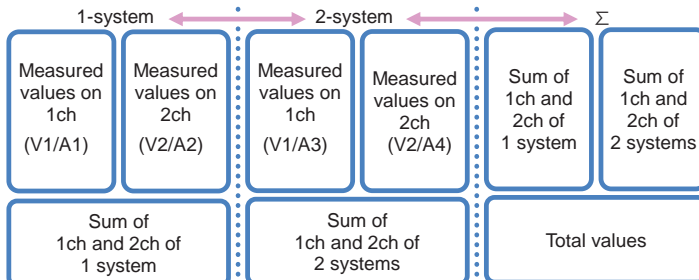

## 6. DISPLAYED ITEMS

### 3P3W-1, -2 (Three-phase, 3-wire, Blondel's theorem, 1 or 2 systems)

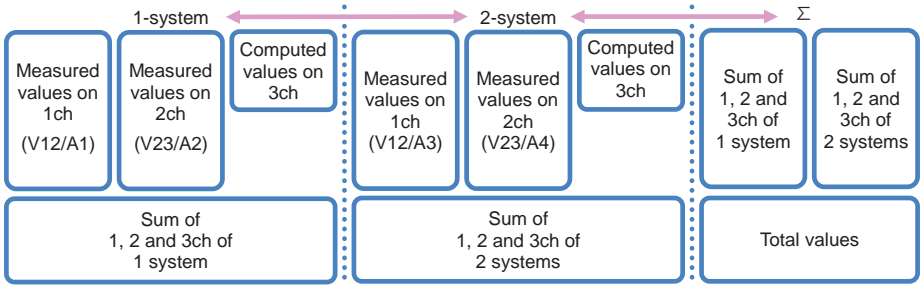

### 3P3W3A (Three-phase 3-wire)

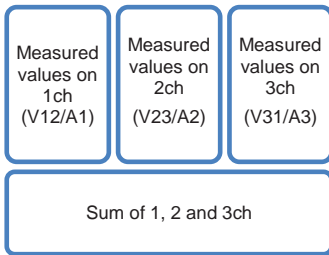

### 3P4W (Three-phase 4-wire)

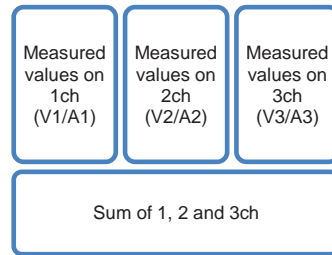

### “Switching the type of displayed values”

The displayed values can be switched between Inst, Avg, Max and Min values with  key. If the selected interval is “1 sec”, Inst, Avg, Max and Min values will be the same since the display update is also “1 sec”.

### “Wh” Integration value”

Press the **F1** (Wh) key and switch the screens to view integration values. Please refer to “6.2 Integration value [Wh]” in this manual.

### “Zoom”

Four or eight measured values can be zoomed and displayed on one screen by pressing the **F2** (Zoom) key. Please refer to “Zoom display” in this manual.

### “Trend graph”

Press the **F3** (Trend) key to show the trend graphs. The displayed time area is from present to the past 60 min. Please refer to “Displaying Trend graph” in this manual.

### “Customize”

Press the **F4** (Customize) key to switch the displayed items and change the display positions. Please refer to “Changing displayed items and display position” in this manual.

## 6. DISPLAYED ITEMS

### Zoom Display

Example: 8-split screen

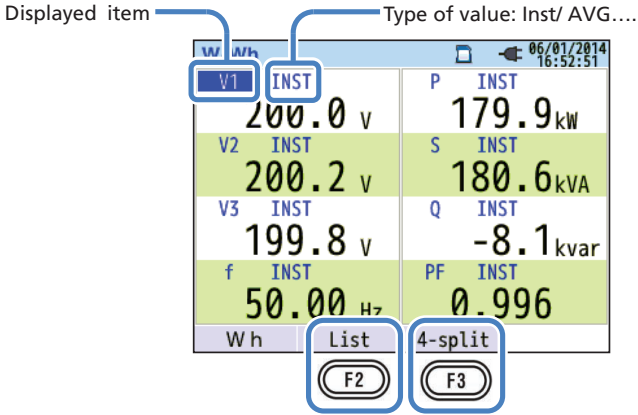

Select 4 or 8 values and display the values on one screen. The displayed text will be enlarged so it is easy to see.

### “Displayed items”

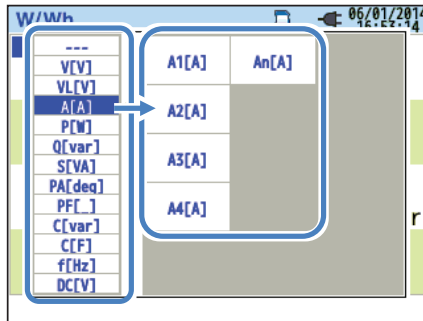

Select the items to be displayed in each column. Then, the selectable items will be displayed to the right.

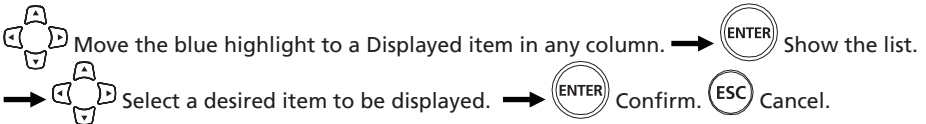





### “Type of value”

Any of the following values can be displayed in each column.

Inst: Instantaneous value, or AVG: Average value, MAX: Maximum value or MIN: Minimum value within the selected interval.

If the selected interval is “1 sec”, Inst, Avg, Max and Min values will be the same since the display update is also “1 sec”.

## 6. DISPLAYED ITEMS

 Move the blue highlight to a Type of value in any column. →  Show the pull-down menu. →  Select a desired item to be displayed. →  Confirm.  Cancel.

### “List display”

Press the  (List) key to display all the values on the list.

### “4-Split”/ “8-Split”

Press the  (4-Split/ 8-Split) key to expand and display 4 or 8 items on one screen.

### Displaying Trend Graph

In the following example, active powers per ch for 1P3W-2 (Single-phase 3-wire, 2-system) are displayed on the graph.

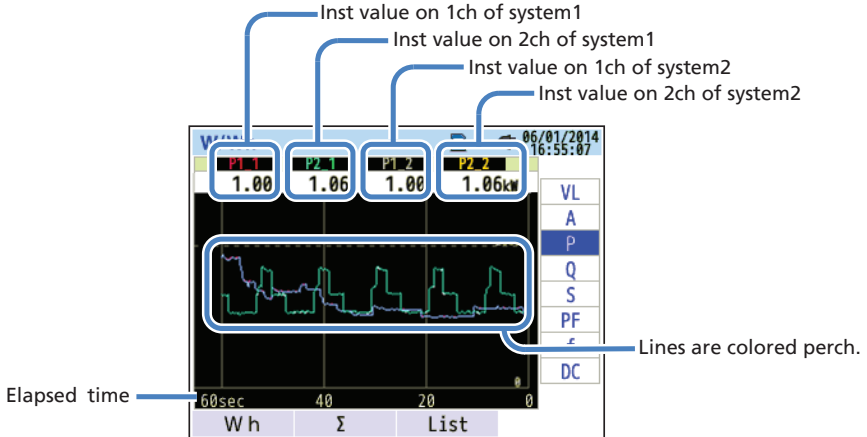

Changes of each measured values can be displayed on the graph.

The following example shows 1P3W-2 (Single-phase 3-wire, 2-system).

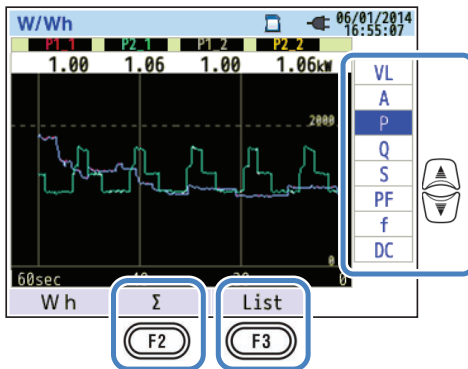

## 6. DISPLAYED ITEMS

### “Change the items displayed on trend graph”

Press the  key and change the items displayed on the trend graph.

### “Σ/CH”

Press the **F2** (Σ/CH) key to switch the graphs: one is to display the sum and total values per system and another is to display the values per ch. The selection of “Σ” or “CH” will be effective for all the trend graphs. When “Σ” is selected, while A: rms current values is selected for 3P4W, An: neutral current values will be displayed on the trend graph.

### “List display”







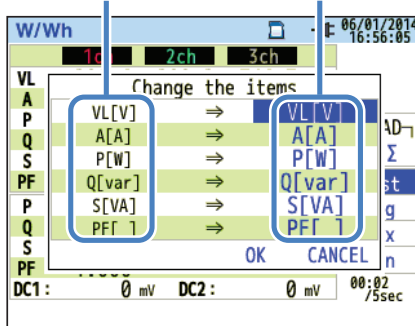

Press the **F3** (List) to show all the values on a list.

### Changing Displayed Items and Display Position

Present displayed items    After the change



The displayed items can be changed to the desired value.

-  Move the blue highlight to the item you want to change. →  Show the pull-down menu. →  Select a desired item. →  Confirm.  Cancel.
-  Select OK/ Cancel. →  Confirm.  Cancel.

When opening the “Change the items” window, presently displayed items are displayed in two rows. The presently displayed items are displayed on the left, and the items to be displayed after the change are displayed in blue on the right. Displayed positions are basically separated into two large categories: one is for voltage/ current and another is for power/ capacitance calc. For the details about the symbols displayed on the screen, please refer to “List display of the measured values”.

## 6. DISPLAYED ITEMS

### 6.2 Integration Value “Wh”

Press the **W/Wh** Key. → **F1** Display the screen for “Wh”: Integration value.

e.g.) 1P3W-2 (Single-phase Three-wire, 2-system)

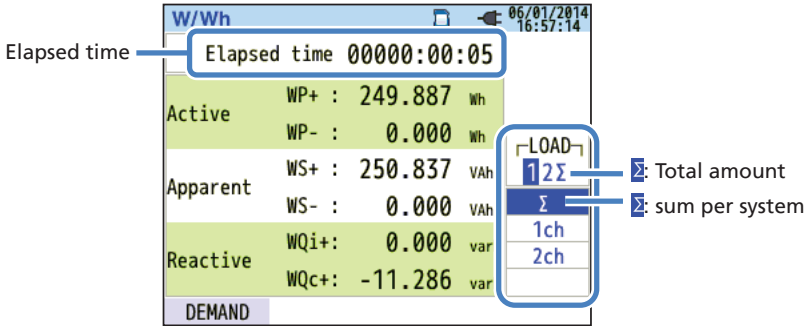

Power used in the certain period is displayed as integral power consumption. Integral power consumption is used to calculate electricity tariffs or to control the power consumption.

Symbols displayed on the screen			
WP	Active power + consumption energy - regenerating		Reactive power + lagging energy - leading
WP	Apparent power + consumption energy - regenerating		

e.g.) 1P3W-2 (Single-phase Three-wire, 2-system)

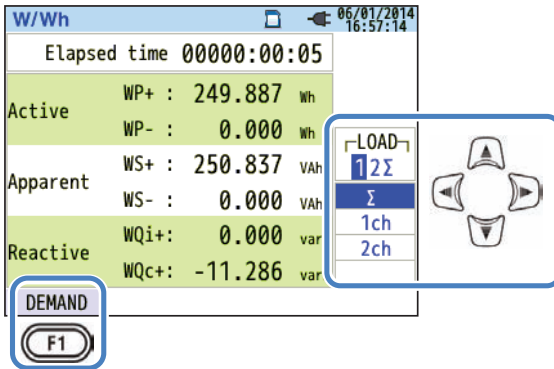

#### “Change the displayed systems”

Press the **◀▶** Key to switch the displayed systems. Please refer to “Setting of wiring system” in this manual.

#### “Change the displayed chs”

Press the **▲▼** Key to switch the displayed channels. Please refer to “Setting of wiring system” on in this manual.

## 6. DISPLAYED ITEMS

### “Demand”

Press the **F1** (Demand) Key to display the screen for demand value. Please refer to “6.3 Demand” in this manual.

### 6.3 “Demand”

Press the **W/Wh** Key. → **F1** Display the screen for demand value.

→  Change the screens to display the demand measurement results in various forms.

### Change the displayed chs”

 Move the blue highlight to “Meas.”.

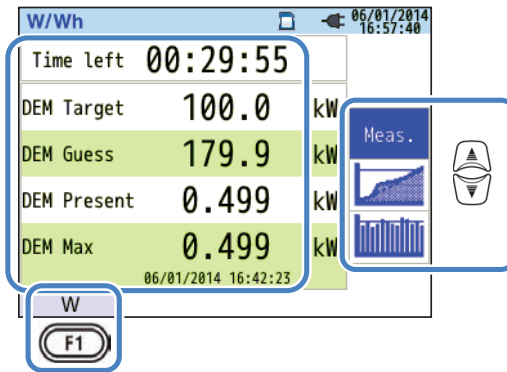

The demand is the average powers recorded over a certain period. When the estimated value exceeds the target value during demand measurements, the warning buzzer sounds at the inspection cycles.

Items displayed on the LCD	
Remaining time (time left)	Demand interval is counted down.
DEM Guess	Predicted demand value (average power) when preset demand interval elapses under present load. $\frac{\text{(Present value)} \times \text{(Present value)}}{\text{(Elapsed time)}}$ * Integration and calculations are done as time elapses.
DEM Present	Demand value (average power) within a demand interval. $\frac{\text{“WP+ x 1 hour”}}{\text{Interval}}$ * Integration and calculations are done as time elapses.
DEM Max Recorded date	Max demand recorded during a measuring period is displayed. Displayed value will be refreshed if any higher demand is detected.



## 6. DISPLAYED ITEMS

### Instantaneous Value "W"

Press the **F1** (W) Key to show instantaneous values on the screen. Please refer to "6.1 Instantaneous value "W" in this manual for further details.

### Shifts in Specific Period

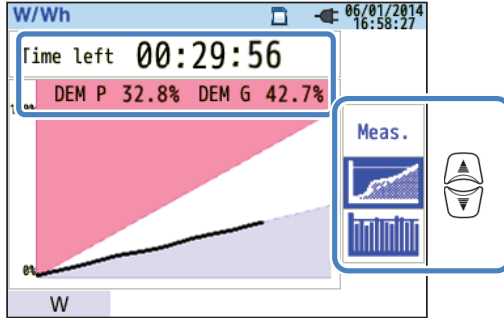

Items displayed on the LCD	
<b>Remaining time (time left)</b>	Demand interval is counted down.
<b>DEM P</b>	Percentage of the present value against the target value. $\frac{\text{Present value}}{\text{Target value}}$ is displayed.
<b>DEM G</b>	Percentage of the predicted value against the target value. $\frac{\text{Present value}}{\text{Target value}}$ is displayed.

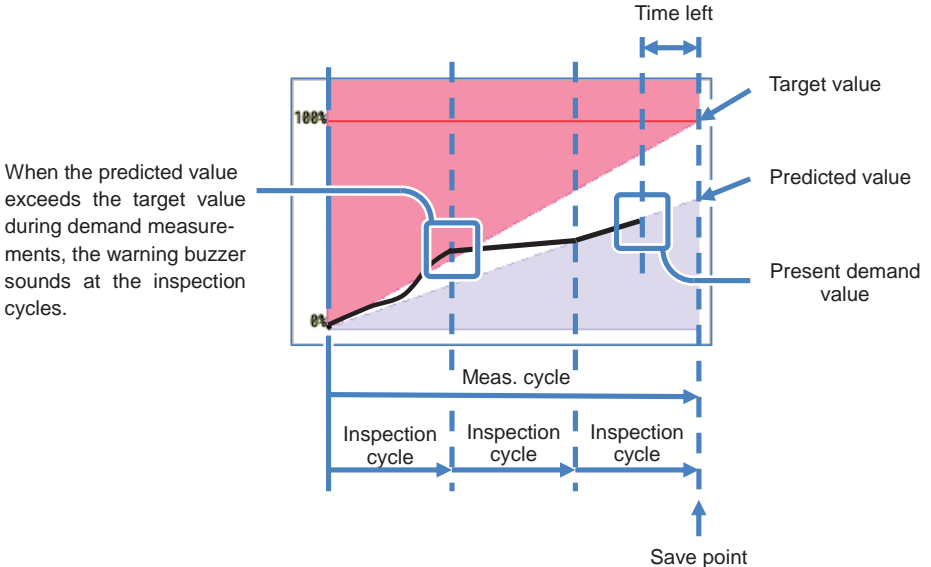

## 6. DISPLAYED ITEMS

### Demand Change

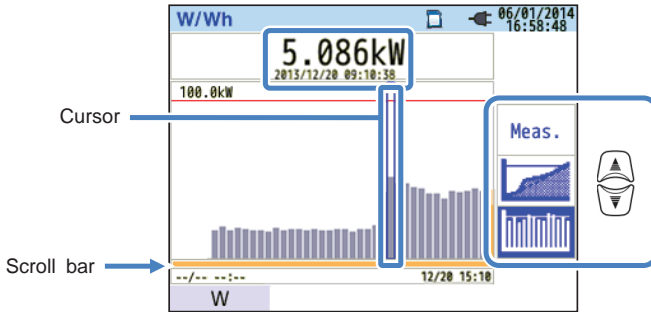

Press the Key to move the cursor and to scroll the graph to right and left. The white bar shows the percentage of hidden pages and the dark orange bar shows the percentage of the present displayed page.

Items displayed on the LCD	
<b>Measured demand/ Recorded date</b>	Demand value is displayed with recorded date & time info where the cursor is located.

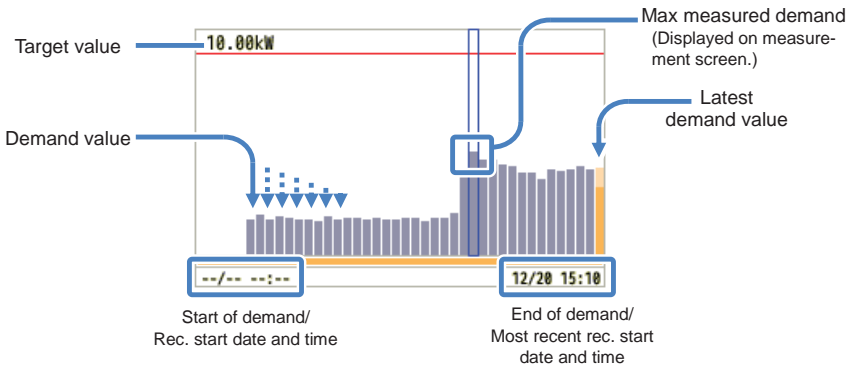

Start of demand/ Rec. start date and time is displayed when the graph exceeds the display area.

# 6. DISPLAYED ITEMS

## 6.4 Vector



Press the **Key**.  
e.g.) 3P4W

Measured values

V: rms voltage<sup>\*1</sup> /Phase angle<sup>\*2</sup>

A: rms current /Phase angle<sup>\*2</sup>

<sup>\*1</sup> For 3P3W3A, rms line voltages are displayed.

<sup>\*2</sup> Phase angled is displayed: using Phase of V1 as the base (0°).

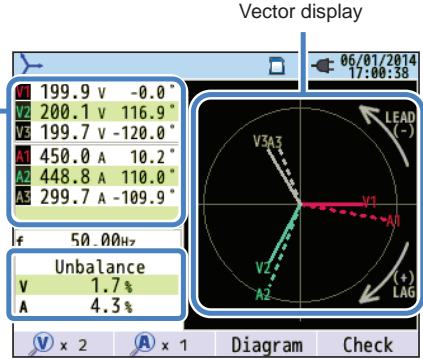

Vector display:

rms voltage (solid line)

rms current (dotted line)

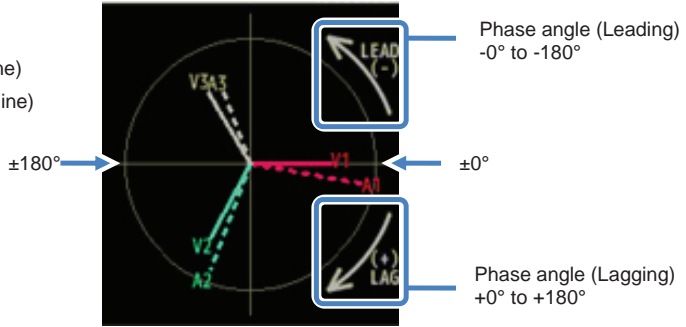

The circle (solid line) represents the max values at V and A Ranges, and the line length represents rms voltage and current values. The angle between the lines represents phase relation with reference to V1. For 3P3W3A/3P4W, unbalance ratio is also displayed. While the measured voltages and currents are balanced, the following vectors will be displayed.

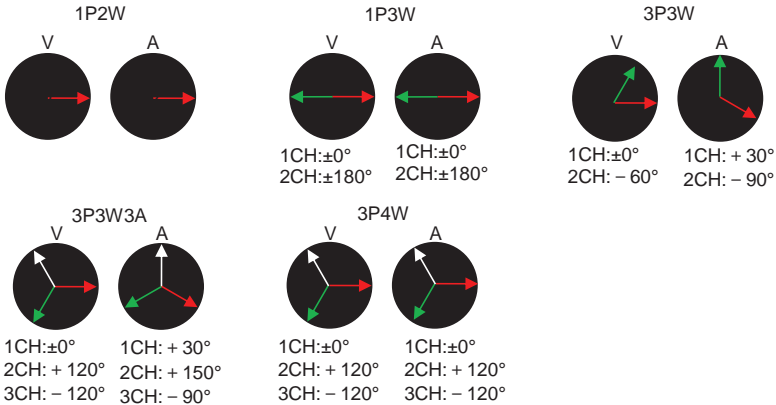

## 6. DISPLAYED ITEMS

e.g.) Vector of 3P4W:

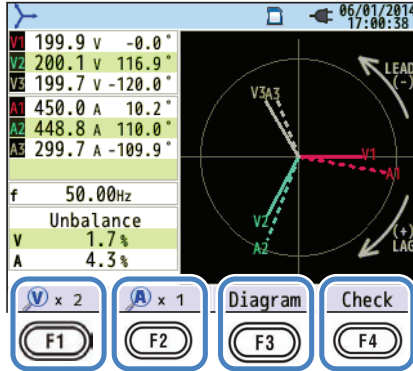

### “V x desired magnification”

**F1** : toggle the line lengths of voltage vector.  
1 → 2 → 5 → 10 \* time(s)

### “A x desired magnification”

**F2** : toggle the line lengths of current vector.  
1 → 2 → 5 → 10 \* time(s)

### “Diagram”

Press the **F3** (Diagram) Key to show the wiring diagram for the selected wiring configuration. Please refer to “Wiring diagram” in this manual for further details.

### “Check”

Press the **F4** (Check) Key to check the wiring connections and show the result. \* NG result may be given, even if the wiring is correct, at the measurement site under bad power factors. Please refer to “Wiring check” in this manual for further details.

# 6. DISPLAYED ITEMS

## 6.5 Waveform

Press the  Key.

e.g.) Waveform of 1P3W-2 (Single-phase 3-wire, 2-system):

Measured values  
 V: rms voltage\*  
 A: rms current

\* For 3P3W3A, rms line voltages are displayed.

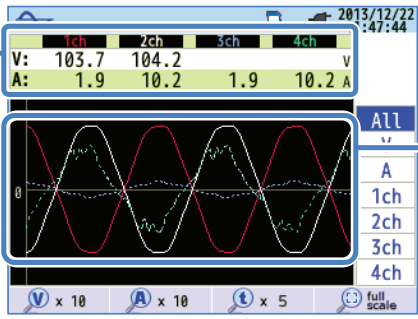

Colored waveforms per ch

Voltage and current waveforms are displayed: for 10 cycles max. at 50Hz, for 12 cycles max. at 60Hz.

When changing the screens for "Waveform", waveforms are displayed in the max scale automatically.

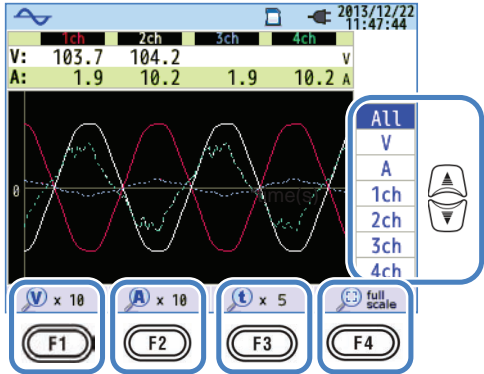

### "Changing the displayed waveforms"

Press the  Key to change the displayed waveforms.

### "V x desired magnification"

**F1** : toggle the magnifications of voltage waveform (vertical).

0.1 → 0.5 → 1 → 2 → 5 → 10 \*time(s)



## 6. DISPLAYED ITEMS

### “A x desired magnification”

**F2** : toggle the magnifications of current waveform (vertical).  
 \*time(s)

### “t x desired magnification”

**F3** : toggle the magnifications of time axis (horizontal).  
 \*time(s)

### “full scale”

**F4** : Restore all the changed magnification settings and automatically select the appropriate magnification.

## 6.6 Harmonics

Press the  Key.

### Displaying Harmonics on the Bar Graph

Press the **F1** (Graph) Key.

e.g.) The following represents 3P4W (Three-phase 4-wire) while “Linear” and “Full-scale display” are selected.

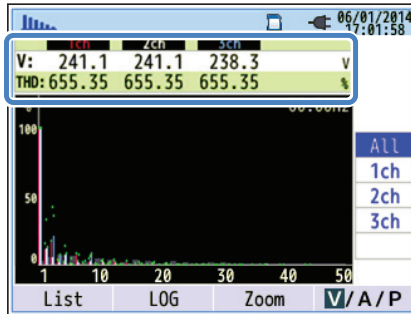

### Symbols displayed on the LCD

V	Voltage	A	Current
	* For 3P3W3A, rms line voltages are displayed.		
THD	Voltage total harmonic distortion is displayed while “V” is displayed and current total distortion factor is displayed while “A” is displayed. Total harmonic distortion is calculated according to the selected THD calculation method		
P	Active power per ch	$\Sigma P$	Reactive power energy (leading)
	+ in - out		+ in - out

## 6. DISPLAYED ITEMS

Bar graph display

e.g.) "Linearity" is displayed in "Full-scale".

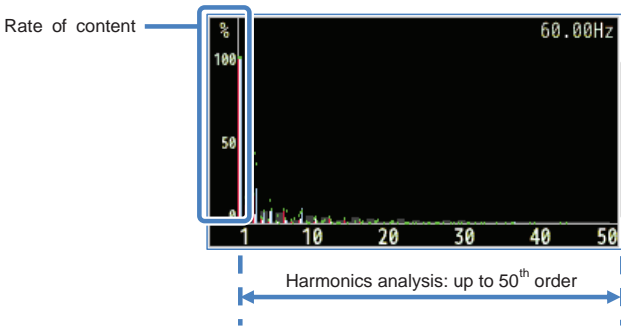

In the above example, "Linear" and "full-scale" are selected. In this case, the upper limit of the rate of content is "100%" and all harmonics, 1st to 50th, are displayed on one screen.

Items displayed on the LCD	
Rate of content	Harmonic content of each order against the 1st basic wave.

e.g.) The following represents 3P4W (Three-phase 4-wire) while "LOG" and "Zoom" are selected.

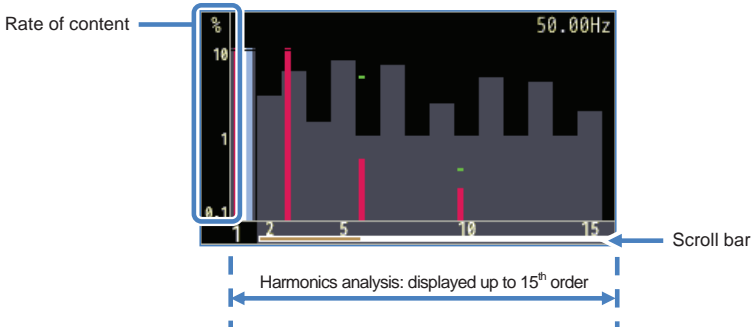

When selecting "LOG" (Logarithm), 10% will be the max percentage of the vertical axis and the harmonics displayed are limited up to 15th order. Press the (◀) (▶) key to scroll the pages. The basic waveform of 1st order is fixed and does not move. The white bar shows the percentage of hidden pages and the dark orange bar shows the percentage of the present displayed page.

e.g.) "Linearity" is displayed in "Full-scale".

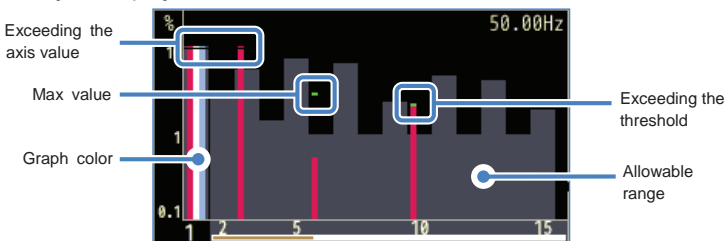

## 6. DISPLAYED ITEMS

Items displayed on the graph	
<b>Exceeding the axis value</b>	Displayed when the rate of harmonics content of each order is more than 10%. The rate of harmonics content of the 1st basic waveform is "100%", therefore, always exceeding the axis value in "LOG" display.
<b>Max value</b>	Max values recorded during measurements are displayed. These values can be reset any of the following methods. * Setting change, start of recording, or long press (2 sec or longer) of  Key.
<b>Graph color</b>	When multiple measurement channels are used, each graph is displayed in different colors.
<b>Exceeding the threshold</b>	Displayed when measured values exceed the preset allowable range.
<b>Allowable range</b>	Preset by default and complied with IEC61000-2-4 Class3. To change the range, select "Edit allowable range." in the "Measurement" setting.

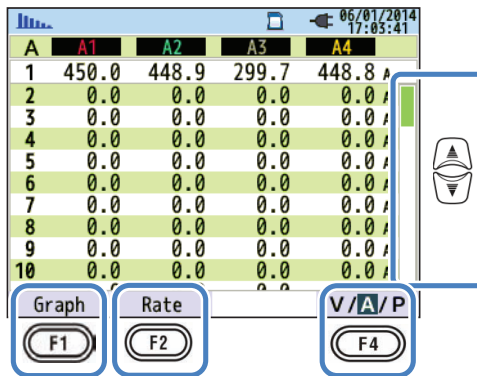

### "Change the displayed chs"

Press the  Key to change the displayed chs. The details about the relation between the wiring configuration and ch are described in "Settings of wiring system".

### "List"/"Graph"

Press the  Key to display voltage/ current/ power harmonics, from 1st to 50th order, in list or graphic form. Only the rate of harmonics content can be checked on graph display screen, but rms value/ rate of content/ phase angle\* can be checked respectively on list display screen.

\* While "P"(Power) is selected and displayed, phase differences between voltage and current are displayed. Inflow:  $\pm 0^\circ$  to  $\pm 90^\circ$ , Outflow:  $\pm 90^\circ$  to  $180^\circ$ .

### "LOG"/ "Linear"



## 6. DISPLAYED ITEMS

Press the **(F2)** (LOG/Linear) Key to switch the display modes. Linear display, with ticks of 0% - 100%, and Logarithm display, with ticks of 0.1% - 10%, are switchable on the vertical axis. It is useful to analyze lower level of harmonics.

### “Full”/“Zoom”

Press the **(F3)** (Zoom/Full) Key to zoom and display fifteen harmonics on one screen. Voltage/ Current/ Power harmonics are separately displayed in graphic form. Press the **(←) (→)** Key to scroll the pages.

### “V/A/P/ΣP”

Press the **(F4)** (V/A/P/ΣP) Key and select the parameter to be analyzed.

### Displaying the List of Harmonics

Press the **(F1)** (List) Key to display the list of harmonics.

e.g.) “P: Power harmonics” and “Power” of 1P3W-2 (Single-phase 2-wire, 2-system) are listed.

P	P1 1	P2 1	P1 2	P2 2
1	88.5	89.1	-20.4	89.1kW
2	0.0	0.0	0.0	0.0kW
3	0.0	0.0	0.0	0.0kW
4	0.0	0.0	0.0	0.0kW
5	0.0	0.0	0.0	0.0kW
6	0.0	0.0	0.0	0.0kW
7	0.0	0.0	0.0	0.0kW
8	0.0	0.0	0.0	0.0kW
9	0.0	0.0	0.0	0.0kW
10	0.0	0.0	0.0	0.0kW
11	0.0	0.0	0.0	0.0kW

Graph    Rate    ΣP

Rms values, rate of content and phase angle of voltage/ current/ power harmonics, from 1<sup>st</sup> to 50<sup>th</sup>, can be displayed in list form respectively.

Symbols displayed on the LCD						
V	Voltage*1			A	Current	
P*2	Active power per ch	+	in	ΣP*2	Sum of each ch /	+
		-	out		total active power	-

\*1 For 3P3W3A, rms line voltages are displayed.

\*2 The letters and numbers displayed on the top represent the displayed parameter and the ch or system number. If there is a space between the alphabet and the following number, the displayed number represents the system number. In this case, the listed values are sum per system. If “P” is displayed alone, the listed values are total amounts.

## 6. DISPLAYED ITEMS

A	A1	A2	A3	A4
1	450.0	448.9	299.7	448.8
2	0.0	0.0	0.0	0.0
3	0.0	0.0	0.0	0.0
4	0.0	0.0	0.0	0.0
5	0.0	0.0	0.0	0.0
6	0.0	0.0	0.0	0.0
7	0.0	0.0	0.0	0.0
8	0.0	0.0	0.0	0.0
9	0.0	0.0	0.0	0.0
10	0.0	0.0	0.0	0.0

Graph (F1)      Rate (F2)      V/A/P (F4)

### “Change the displayed harmonics orders”

Press the  Key to scroll the page vertically.

### “Graph”/ “List”

Press the  Key to display voltage/ current/ power harmonics, from 1st to 50th order, in list or graphic form. Only the rate of harmonics content can be checked on graph display screen.

### “Rate of content”/“Phase angle”/ RMS value (Power)”

Press the  (Rate/ DEG/ RMS) Key to change the displayed items on the list. While “V”:voltage or “A”: Current are displayed on the screen, Rate/ DEG (phase angle with V1 basis (0o)) / RMS are switchable. While “P” (ΣP): Power is displayed, Rate/ DEG (voltage/ current phase angle per ch) / Power are switchable.

### “V/A/P/ΣP”

Press the  (V/A/P/ΣP) Key and select the items to be analyzed: V: voltage/ A: Current/ P: Power (ΣP: Sum per system, Total amount).

6. DISPLAYED ITEMS

6.7 Power Quality

Press the **QUALITY** Key to display Power quality screen.

Factors Impair Power Quality and Symptoms

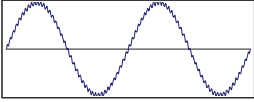
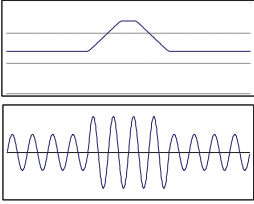
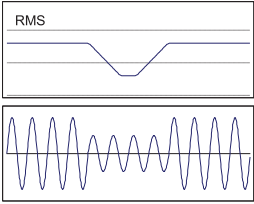
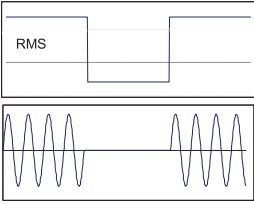
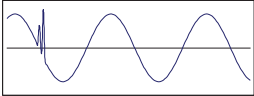
Power quality	Waveform	Symptom	Adverse effect
Harmonics		Inverter and Thyristor circuits (phase-control circuit) are used for the control circuit of general devices; these circuits affect currents and cause harmonics.	Burnout of capacitors and reactors, buzzes from transformers, malfunction of circuit breakers, flicker on screens or noises on stereos due to currents with harmonic components.
Swell		Inrush currents occur when switches for power lines are on, and then voltages increase instantaneously.	
Dip		Inrush currents occur when motor loads are activated, and dip in current occurs.	Shutdown of devices or robots or reset on computers and equipment may be caused.
INT		Power supply is interrupted for a second due to lightning strikes.	
Transient, Over-voltage (impulse)		Contact failure at a circuit breaker, magnet or relay.	Damage to a power source or reset of the device may occur due to a drastic voltage fluctuation (spike).

## 6. DISPLAYED ITEMS

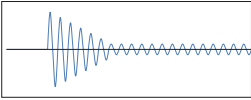
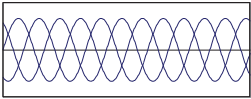
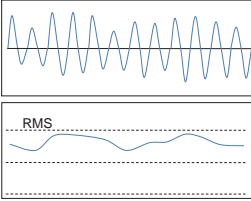
Power quality	Waveform	Symptom	Adverse effect
Inrush current		Instantaneous large currents (surge) flow on devices with a motor, incandescent lamp and flat capacitor when powering them on.	Burnout of capacitors and reactors, buzzes from transformers, malfunction of circuit breakers, flicker on screen or noises on stereos due to currents with harmonic components.
Unbalance rate		Heavy loading on specific phase due to fluctuations in load of power line or drastic extension of installations. Distortions of voltage / current waveforms, dip and negative sequence voltages are caused.	Influences on voltage, current, motor operation occur; negative sequence voltage and harmonics occur.
Flicker		Too much load is caused on certain phases due to increase and decrease of the loads connected to each phase such as supply lines or heavy use of specific equipment, As a result, distortions on voltage and current waveforms, dip and reversed voltages are observed.	Unbalanced or reversed voltages and harmonics occur and result in motor instability, trip of 3E circuit breaker or heating due to overload.









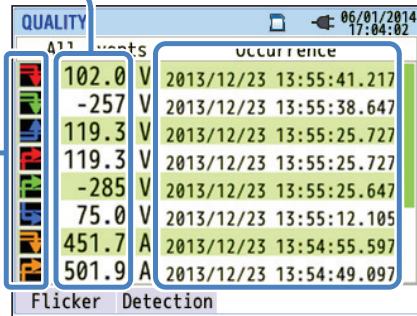

**Displaying Recorded Events**

Press the **F1** (Event) Key to display the list of the recorded events.

Measured values

Symbol indicating event type



Items and symbols displayed on the LCD	
Symbol	Start → End
	Swell  → 
	Dip  → 
	INT  → 
	Transient  → 
	Inrush current  → 
Measured value	Instantaneous values recorded at the detection of the start and end of the event. If the occurred event terminates in a significantly short period, the value measured at the end of the event may not be displayed. To check the r.m.s. values recorded before/ after the detection, please check r.m.s. variation data. Interval measurement data will be helpful to check the measured values of long lasting events. To record power quality events, short interval is useful in analysis.
Occurred time and date	Time and date when DM-5 detect the start and end of the event.

**Event detection on poly-phase systems.**

**"INT"**

When INT states are detected on all the chs selected according to the wiring configuration, it is regarded as the start of the event. When the INT state ends on any of the measurement chs, it is regarded as the end of the event.

**"Swell"/ "Dip"/ "Inrush current"/ "Transient"**

When voltage or current falls into any event states on any one of the measurement chs selected according to the wiring system, it will be regarded as the start of the event. When the state ends on all measurement chs, it is regarded as the end of the event.

## 6. DISPLAYED ITEMS

### Measurement of Swell/ Dip/ INT/ Inrush current

Each event will be detected with the r.m.s. values in one gapless waveform and with a half-wave over-lapping. The beginning of the waveform where the first event is detected is regarded as the start of the event. If further events are not detected in the following waveform, the beginning of the waveform is regarded as the end of the event. The detected event is assumed to be continued between the start to the end of event detection.

Example of Dip detection

\* INT is detected in the same method.

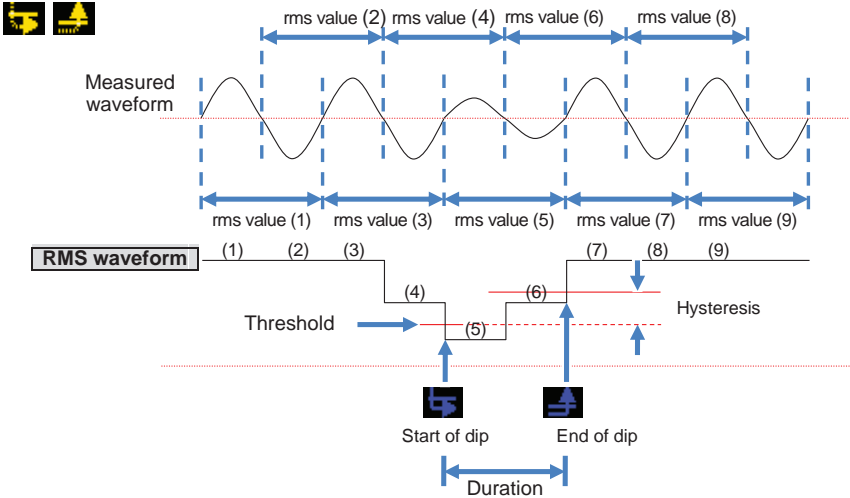

Example of Swell detection

\* Inrush current is detected in the same method.

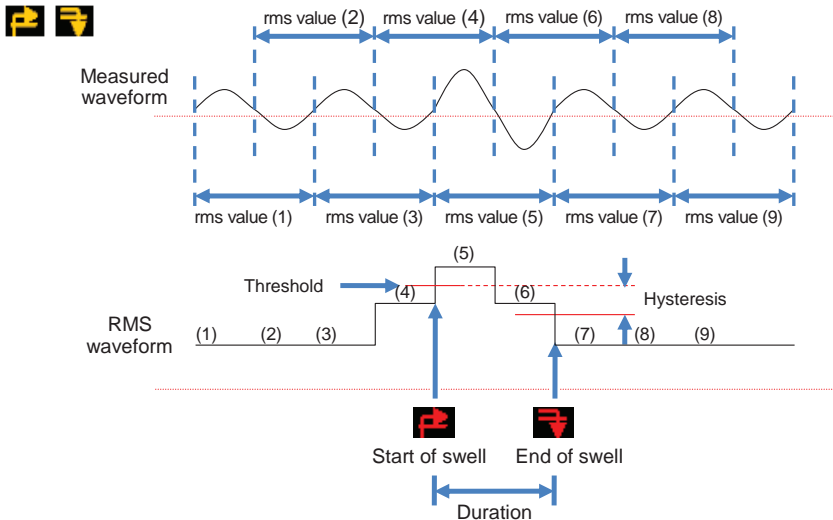

## 6. DISPLAYED ITEMS

### Detection of Transient

Voltage waveforms will be monitored at approx 40kpsps, gapless, to calculate and check for transient event every 200ms. The beginning of the 200ms period where the first transient is detected is regarded as the start of the event. If further events are not detected in the following 200ms period, the beginning of the period is regarded as the end of the event. The detected transient is assumed to be continued between the start to the end of event detection.

Example of Transient detection

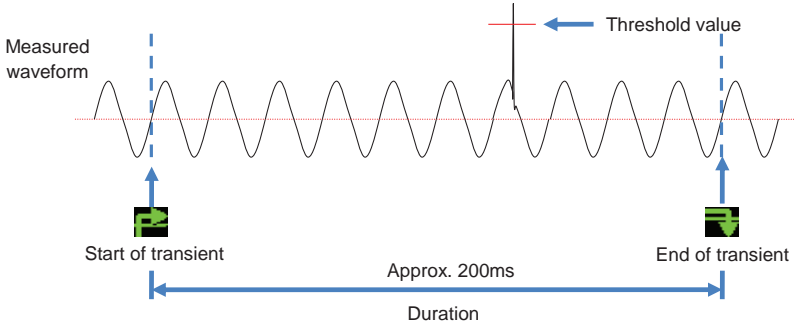

### Save data

When an event occurs, event type, time of start/ end and measured values will be recorded together with the following data.

Event waveform

Waveforms and also event data on all the chs are recorded for approx. 200ms (50Hz: 10-cycle, 60Hz: 12-cycle) at 8192 points in total. When different events occur within 1 sec, only the waveforms which contain the highest-priority events will be recorded. However, if the same type of events occur at the same time, the one containing the highest (deepest) values will be recorded. If the highest (deepest) values are also the same, the one with a longer duration will be recorded. As for the channels, there is no priority order.

[Priority order]: Voltage transient -> INT -> Dip -> Swell -> Inrush current

RMS variations

Voltage/ current rms value variations and event data on all chs are recorded for 1 sec.

Example of Dip detection for approx. 800ms (saved data)

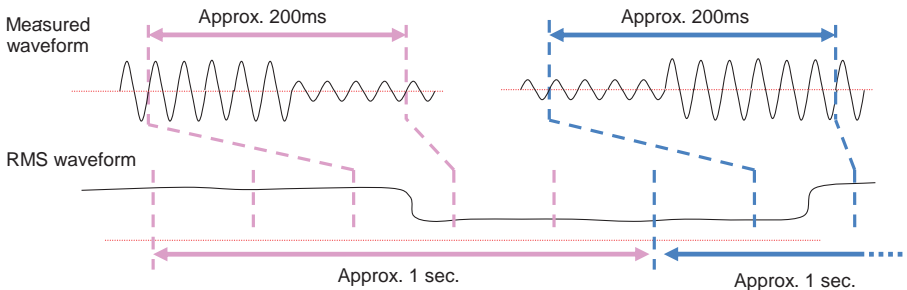

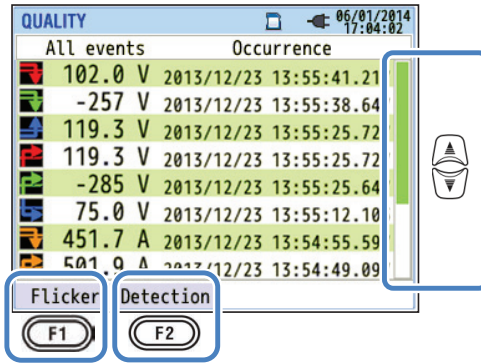

**“Change the displayed area”**

Press the Key to scroll the page vertically.

**“Flicker”**

Press the **(F1)** (Flicker) Key to display the recorded flicker values. Details are described in **“Displaying measured flicker values in list form”**

**“Event detection”**

Press the **(F2)** (Detection) Key and toggle the displayed type of event.

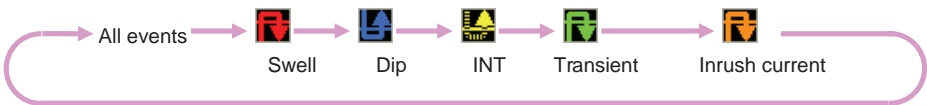

**Displaying Measured Flicker Values in List Form**

Press the **(F1)** (Flicker) Key.

➔ Press the Key to change the displays: V: List display/ Pst(1min): Trend graph/ Plt: Transitional change.

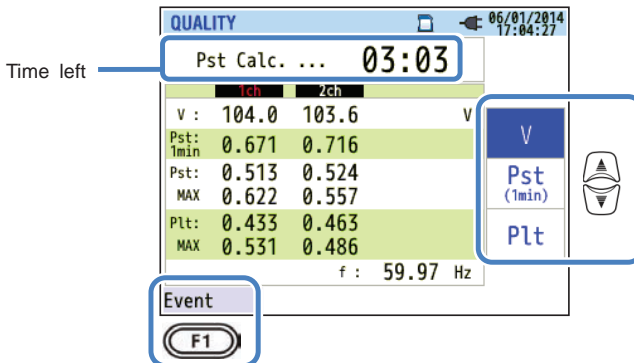



## 6. DISPLAYED ITEMS

If variable loads, such as arc furnace, are connected, voltages may vary and cause changes in illumination levels. Such phenomenon is called "voltage flicker" and its severity level is indicated by "Pst" and "Plt".

Items displayed on the LCD	
Time left	Counted down time until a Pst calculation completes. Usually it takes about 10 min.
V	Phase voltage * For 3P3W and 3P3W3A, rms line voltages are displayed.
f	Frequency
Pst,1min	Severity of short term (1 min) flicker. It is useful for power quality survey or study.
Pst	Severity of short term (10 min) flicker.
Pst,MAX	Max Pst recorded through the beginning to the end of measurement. It is refreshed every time when the measured values exceed the previous max values.
Plt	Severity of long term (2 hours) flicker.
Plt,MAX	Max Plt recorded through the beginning to the end of measurement. It is refreshed every time when the measured values exceed the previous max values.

### "Event"

Press the **F1** (Event) Key to display the recorded events. Please refer to "Displaying recorded events" in this manual.

### Displaying Trend Graph of Pst, 1 min

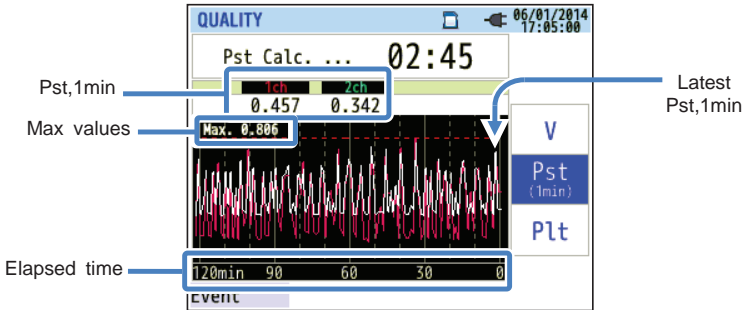

The "Pst, 1min" measured in the recent 120 min is displayed on the trend graph.

Items displayed on the LCD	
Pst,1min	The latest Pst (1 min)
Max value	Max "Pst, 1min" recorded through the measurement. It refreshes every time the measured values exceed the previous max values.
Elapsed time	The latest measured value is displayed at the right end (on 0 min tick), and it shifts to left as time goes by. Changes in the recent 120 min can be displayed on one screen.

## 6. DISPLAYED ITEMS

### Displaying Changes of Plt

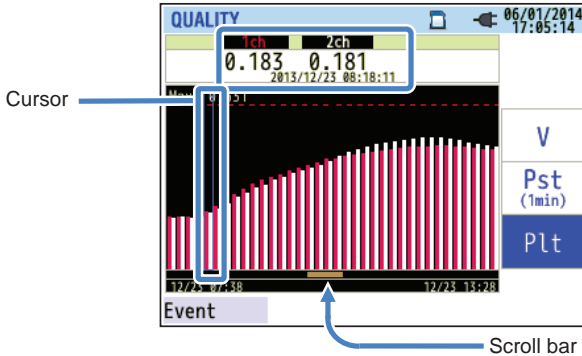

Press the  $\leftarrow$   $\rightarrow$  Key to move the cursor or to scroll the page to right and left. The black bar shows the percentage of hidden pages and the dark orange bar shows the percentage of the present displayed page.

Items displayed on the LCD	
<b>Measured Plt / Recorded date</b>	Plt per ch is displayed with recorded date & time info where the cursor is located.

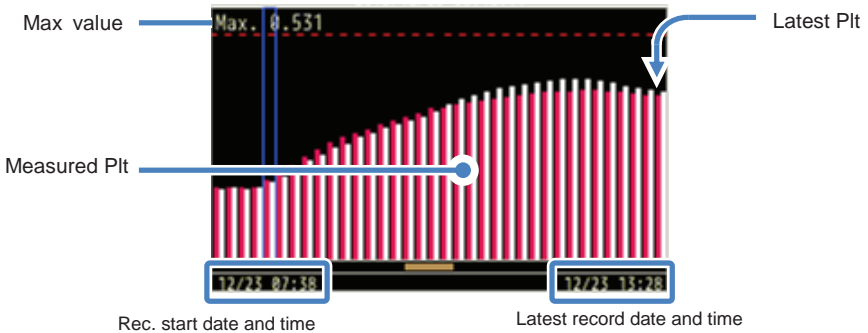

The rec. start date and time is displayed when changes of Plt cannot be described on one page.

Items displayed on the LCD	
<b>Max value</b>	Max Plt recorded from the beginning of the record until now. It is refreshed every time when the measured values exceed the previous max values.

## 7. OTHER FUNCTIONS

---

### “Data hold”

Display update can be disabled by pressing the “DATA HOLD” Key. The  icon will appear while display update is disabled. The icon will disappear and display update will be enabled by pressing the “DATA HOLD” Key again. Switching screens is still available. Moreover, measured values and event information are continuously recorded even while the Data hold function is activated.

### “Key lock”

Pressing the “DATA HOLD” Key 2 sec or more disables all Keys, except for LCD key, and  icon appears. Another long press (2 sec or more) is required to restore the disabled Keys.

### “Turning off the Backlight”

Press the LCD Key to turn off the backlight. Pressing any keys, except for the Power key, turns on the backlight again.

### “Backlight Auto-off”

#### While DM-5 is connected to an AC power source:

The LCD backlight is turned off automatically 5 min after the last key operation. Press any key except for the Power key to turn on the light again. To disable the Backlight auto-off function, select “Disable auto-off” on the setup menu.

#### While DM-5 operates with battery:

The brightness will be cut by half. The backlight will be automatically turned off 2 min after it is turned on. Press any key except for the Power Key to turn on the backlight again. The backlight does not stay on continuously while the instrument is operating with batteries.

### “Auto-power-off”

#### While DM-5 is connected to an AC power source:

The instrument is powered off automatically 5 min after the last key operation. This function does not operate while the instrument is recording data. Press the Power key to power on the instrument again. To disable the auto-power-off function, select “Disable auto-off” on the setup menu.

#### While DM-5 operates with battery:

The instrument is powered off automatically 5 min after the last key operation. This function does not operate while the instrument is recording data. Press the Power key to power on the instrument again.

### “Auto-ranging” (Current range)

Current ranges of each sensor are automatically switched according to the measured rms currents. This function does not work while recording the power quality events. A range shifts to one upper range when the input exceeds 300%peak of each range and shifts to one lower range when the input drops under 100%peak of each range. However, while “AUTO” is selected, the upper range will be adopted to display the values.

## 7. OTHER FUNCTIONS

---

### **“Sensor detection”**

Press the “Detection” key on the SETUP menu to detect the connected clamp sensors. The DM-5 automatically detects the connected sensors and checks the settings of the sensors.

### **“Recovery from power failure”**

When the power supply to the instrument is inadvertently lost during a record, the interrupted record will be resumed after the power supply is restored.

### **“Print screen”**

Press the “PRINT SCREEN” Key to save the displayed screen as a BMP (bitmap) file.

\* Max file size: approx. 77KB

### **“Retain settings”**

Settings used during the previous test will not be cleared after powering off the instrument. DM-5 retains and adopts the previous settings. \* Default values will be displayed for the first time after purchase.

### **“Quick start guide”**

Press the “START/STOP” Key to run the “Quick start guide”.

### **“Status indicator”**

The red indicator LED blinks when the backlight is off, and the green indicator LED stays on during recording regardless of the backlight function. The green indicator LED blinks during stand-by mode.

## 8. DEVICE CONNECTION

### 8.1 Data Transfer to PC

Data in the SD card or the internal memory can be transferred to PC via USB or SD card reader.

	Method of transfer	
	USB	Card reader
SD card data (file)	△*1	○
Internal memory data (file)	○	-----

\*1: It is recommended to transfer the large data by use of SD card since transferring large data files by USB requires more time than using the SD card reader. (transfer time : approx 320MB/Hour) As to the manipulation of SD cards, please refer to the instruction manual attached to the card. In order to save data without any problem, make sure to delete the files other than the data measured with this instrument from the SD card beforehand.

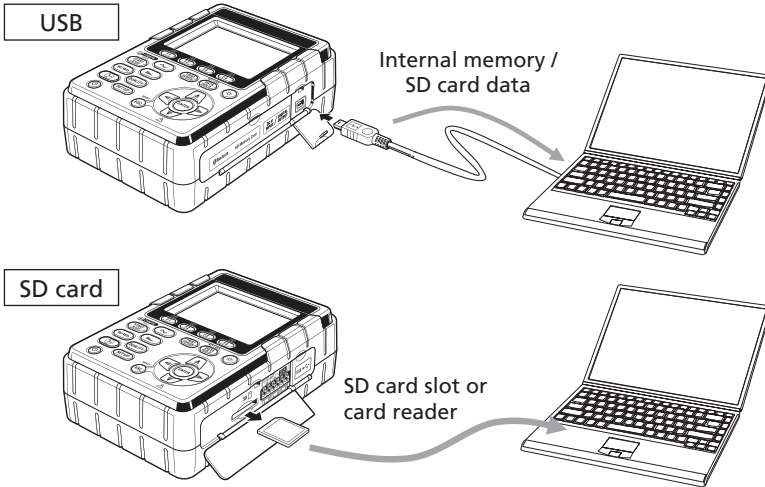

### 8.2 Using a Bluetooth® Enabled Device

Measuring data can be checked wirelessly on compatible Bluetooth® enabled Android and Windows devices. It is necessary to enable Bluetooth® function prior to using Bluetooth® communication.

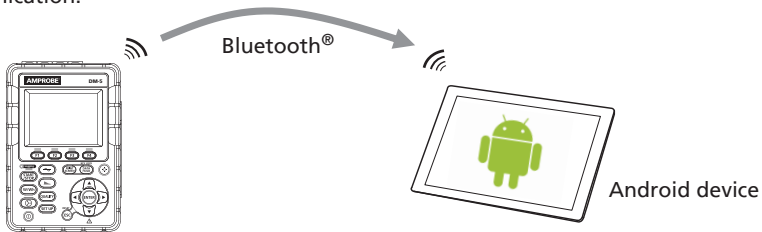

Before starting to use this function, download the special application "DM-5" from [www.Amprobe.com](http://www.Amprobe.com).

The application "DM-5" is available on the download site for free. (Internet access is required and charges may be incurred.)

\* "Bluetooth®" is a registered trademark of Bluetooth SIG.

## 8. DEVICE CONNECTION

### 8.3 Signal Control

#### Connection to Input/ Output Terminals

#### ⚠ CAUTION

- Voltages applied to the terminals should not exceed the following ranges.  
\* for input terminals: within  $\pm 11V$ , for output terminals: between 0 and 30V(50mA, 200mW) Otherwise, the instrument may be damaged.
- The root of each L-terminal is the same. Do not connect different ground levels of multiple inputs at the same time. Roots of the L terminals for each Ch are integrated. Never connect inputs with various ground levels to the terminal at the same time.

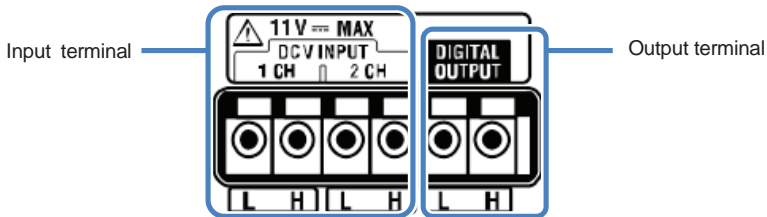

Ensure that the wires are connected to proper terminals.

Wires of following dimensions can be used.

Suitable wire : single-wire  $\Phi 1.2$  (AWG16), twisted wire 1.25mm<sup>2</sup> (AWG16),  
strand size  $\Phi 0.18$ mm or more

Usable wire : single-wire  $\Phi 0.4 - 1.2$  (AWG26 - 16), twisted wire 0.2 - 1.25mm<sup>2</sup> (AWG24 - 16),  
strand size  $\Phi 0.18$ mm or more

Standard length of bare wire: 11mm

1. Open the connector cover.
2. Press the rectangular protrusion above a terminal with a flat-blade screw driver, and insert a signal wire.
3. Remove the driver and fix the wire.

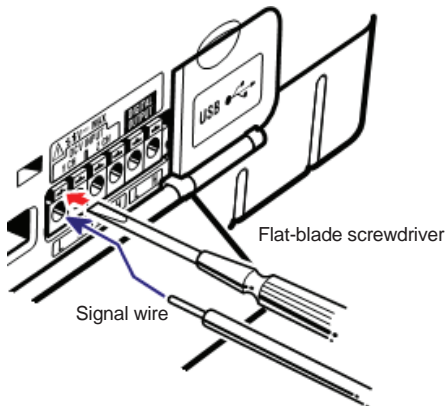

## 8. DEVICE CONNECTION

### “Input terminal”

For monitoring the voltage output signals of thermo sensors. These terminals are useful to measure the signals from other devices and power failures at the same time.

Number of Ch: 2ch

Input resistance : approx 225.6k $\Omega$

### “Output terminal”

For fixing the generating outputs to “Low” during power quality events. Usually, it is fixed to “High”, but changed to “Low” if the duration of an event is less than 1 sec. This is applicable to the events with the highest-priority only. To adjust the generating outputs to the events with low-priority, select “OFF” for the events with higher priority than the desired event. The details are described in “**Threshold setting for Power quality (Event)**”.

\* [Priority order]: Transient -> INT -> Dip -> Swell -> Inrush current

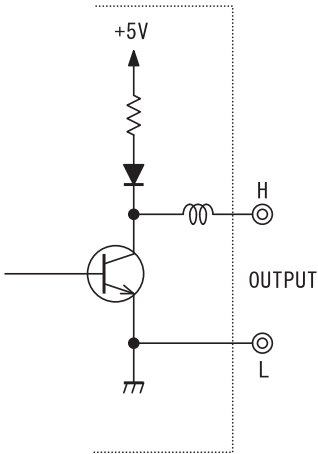

Output format : Open collector output

Max input : 30V, 50mA, 200mW

Output voltage : Hi – 4 to 5V

Lo – 0 to 1V

## 8. DEVICE CONNECTION

### 8.4 Getting Power from Measured Lines

If it is difficult to get power from an outlet, the DM-5 operates with power from the measured line by using the PC-5 Power Adapter and voltage test leads.

#### **⚠ DANGER**

- When the instrument and the test lead are combined and used together, whichever lower category either of them belongs to will be applied. Confirm that the measured voltage rating of the test lead is not exceeded.
- Do not connect a voltage test lead unless required for measuring the desired parameters.
- Connect voltage test leads to the instrument first, and only then connect them to the measured line.
- Never disconnect the voltage test leads from the connectors of the instrument during a measurement (while the instrument is energized).
- Connect to the downstream side of a circuit breaker since a current capacity at the upstream side is large.

#### **⚠ WARNING**

- Power off the instrument before connecting the adapter and test leads.
- Connect voltage test lead to the instrument first. It should be firmly connected.
- Never attempt to make measurement if any abnormal conditions are noted, such as a broken cover and exposed metal parts.

Connect the adapter according to the following procedure.

1. Confirm that the power switch on PC-5 is "OFF".
2. Connect the plug of PC-5 to VN and V1 terminals on the DM-5.
3. Connect the power plug of PC-5 to the power connector on the DM-5.
4. Connect the voltage test leads to VN and V1 terminals of the adapter.
5. Connect the alligator clips of the voltage test leads to the circuit under test.
6. Power on PC-5.
7. Start the DM-5.

\* Reversed procedure is applied to remove the Adapter from DM-5

Please refer to the instruction manual for PC-5 for further details.

<p><b>PC-5</b> Measurement CAT.III 150V CAT.II 240V Fuse rating : AC500mA/ 600V, Fast acting, <math>\Phi 6.3 \times 32\text{mm}</math></p>
--

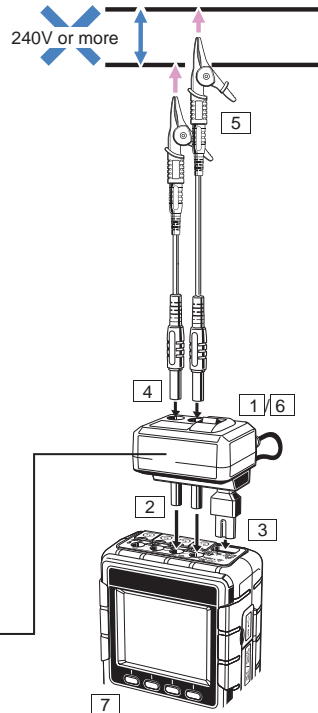



## 9. PC SOFTWARE FOR SETTING AND DATA ANALYSIS

The data analysis and settings software "Windows for DM-5" is available for the DM-5.

- \* Automatic creation of graphs and tables from recorded data.
- \* Uniform management of settings and recorded data acquired from multiple devices.
  - Data can be expressed in crude oil and CO2 equivalent values in reports.

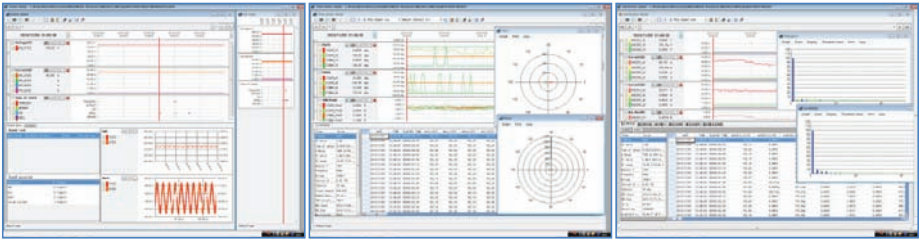

Please refer to the installation manual for "Windows for DM-5" and install the application and USB driver in your PC.

- Interface

This instrument is equipped with USB and wireless interfaces for connecting to Bluetooth® enabled devices.

Communication method : USB Ver2.0

Bluetooth® : Bluetooth® Ver2.1+EDR (Class2)

Compliant profile: SPP

- The following can be done by USB/ Wireless connectivity

- \* Downloading files in the internal memory of the instrument to a PC
- \* Making settings for the instrument via a PC
- \* Displaying the measured results on a PC as graphs in real-time and also saving the measured data at the same time

- System Requirements

- \* OS (Operation System)

Windows® 8/ 7/ Vista/ XP

- \* Display

1024 × 768 dots, 65536 colors or more

- \* HDD (Hard-disk space required)

1Gbyte or more (including Framework)

- \*.NET Framework (3.5 or more)

- Trademark

- \* Windows® is a registered trademark of Microsoft in the United States.

- \* Bluetooth® is a registered trademark of Bluetooth SIG.

The latest software is available for download from our website.

<http://www.Amprobe.com>

## 10. SPECIFICATION

### 10.1 Safety Requirements

<b>Location for use</b>	In door use, Altitude up to 2000m
<b>Temperature &amp; humidity range</b>	23°C±5°C, Relative humidity 85% or less (no condensation) (guaranteed accuracy)
<b>Operating Temperature &amp; humidity range</b>	0°C to 45°C, Relative humidity 85% or less (no condensation)
<b>Storage Temperature &amp; humidity range</b>	-20°C to 60°C, Relative humidity 85% or less (no condensation)
<b>Withstand voltage</b>	AC5160V/ for 5 sec. Between (AC Voltage input terminal) and (Enclosure)  AC3310V/ for 5 sec. Between (AC Voltage input terminal) and (Current input terminal, Power connector, USB connector)  AC2210V/ for 5 sec. Between (Power connector) and (Current input terminal, USB connector, Enclosure)
<b>Insulation resistance</b>	50MΩ or more / 1000V; Between (Voltage/Current input terminal, Power connector) and (Enclosure)
<b>Applicable standards</b>	IEC 61010-1 Measurement CAT.IV 300V CAT.III 600V CAT.II 1000V
<b>Dust-/ water-proof</b>	IEC 60529 IP40

### 10.2 General Specification

<b>Measured line and Input ch</b>	Current ch (A2-A4) unrelated to the selected wiring system can be used for any measurement purpose.		
	Wiring system	Input ch	
		Voltage	Current
	Single-phase2-wire-1-system (1P2W-1)	VN-V1	A1
	Single-phase2-wire-2-system (1P2W-2)	VN-V1	A1,A2
	Single-phase2-wire-3-system (1P2W-3)	VN-V1	A1,A2,A3
	Single-phase2-wire-4-system (1P2W-4)	VN-V1	A1,A2,A3,A4
	Single-phase3-wire-1-system (1P3W-1)	VN-V1,V2	A1,A2
	Single-phase3-wire-2-system (1P3W-2)	VN-V1,V2	A1,A2,A3,A4
	Three-phase3-wire-1-system (3P3W-1)	VN-V1,V2	A1,A2
Three-phase3-wire-2-system (3P3W-2)	VN-V1,V2	A1,A2,A3,A4	
Three-phase3-wire(3P3W3A)	V1-V2,V2-V3,V3-V1	A1,A2,A3	
Three-phase4-wire(3P4W)	VN-V1,V2,V3	A1,A2,A3	
<b>LCD</b>	3.5inch, TFT, QVGA(320×RGB×240)		

## 10. SPECIFICATION

<b>Display update</b>	every 1 sec* * There may be time lag in display update (max. 2 sec) due to arithmetic processing, however, there is no time lag between the recorded data and the time stamp. Backlight (Press the LCD Key to turn off, press any key other than "Power" to turn on.)		
<b>PQ measurement</b>	IEC 61000-4-30 Ed.2 Class S		
<b>Dimension</b>	175(L)×120(W)×68(D)mm		
<b>Weight</b>	approx. 900g (including batteries)		
<b>Accessories</b>	1 DM-5 power quality meter 1 CT-53 flex AC current clamp 1 CT-500 flex AC current clamp 4 Test lead with alligator clip (red/black/blue/green) 1 US power cord 1 SD card (2G) 1 USB cable 32 Cable tie (8 colors) 6 AA batteries 1 User manual 1 PC Software (CD ROM) 1 Carrying case		
<b>Accuracy</b>	within ±5 sec/ day		
<b>Power source</b>	<b>AC power supply</b>		
	Voltage range	AC100V(AC90V) - AC240V(AC264V)	
	Frequency	50Hz(47Hz) - 60Hz(63Hz)	
	Power consumption	7VAmax	
	<b>DC power supply</b>		
		Dry-cell battery	Rechargeable battery
	Voltage	DC3.0V (1.5V×2 in series × 3 in parallel)	DC2.4V (1.2V×2 in series × 3 in parallel)
	Battery	Size AA Alkaline (LR6)	Size AA Ni-MH (1900mA/h)
Current consumption	1.0A typ.(@3.0V)	1.1A typ.(@2.4V)	
Battery life *ref. value at 23°C	3 hours: Backlight OFF	4.5 hours: Backlight OFF * with fully charged batteries	
<b>Real-time OS</b>	This Product uses the Source Code of T-Kernel under T-License granted by the T-Engine Forum ( <a href="http://www.t-engine.org">www.t-engine.org</a> ) Portions of this software are copyright (c) 2010 The FreeType Project ( <a href="http://www.freetype.org">www.freetype.org</a> ). All rights reserved.		

## 10. SPECIFICATION

### External communication function:

USB * USB cable length: 2m max.	
<b>Connector</b>	mini-B
<b>Communication method</b>	USB Ver2.0
<b>USB identification no.</b>	Vendor ID: 12EC(Hex) Product ID: 6315(Hex) Serial no.: 0+7 digit individual no.

Bluetooth®	
<b>Communication method</b>	Bluetooth®Ver2.1+EDR Class2
<b>Profile</b>	SPP
<b>Frequency</b>	2402 - 2480MHz
<b>Modulation method</b>	GFSK(1Mbps), $\pi/4$ -DQPSK(2Mbps), 8DPSK(3Mbps)
<b>Transmission system</b>	Frequency-hopping system



### Digital output terminal:

Normally, it is set to "High". It changes to "Low" while the measured values are exceeding the thresholds set for each power quality event. Usually, it is fixed to "High", but changed to "Low" if the duration of an event is less than 1 sec. This is applicable to the events with the highest-priority only. To adjust the generating outputs to the events with low-priority, select "OFF" for the events with higher priority than the desired event.



\* [Priority order]: Transient -> INT -> Dip -> Swell -> Inrush current

<b>Connector</b>	Terminal block with 6-polarity (black, red, gray ML800-51H-6P)
<b>Output format</b>	Open collector output, Low active
<b>Input voltage</b>	0 - 30V, 50mAmax, 200mW
<b>Output voltage</b>	High:4.0V-5.0V, Low:0.0 - 1.0V

### Data storage location:

Internal FLASH memory	
<b>Storage capacity</b>	4MB (Data storage capacity: 3,437,500 byte)
<b>Max data size</b>	14,623 byte/data (max: 234 data) * 3P3W-2/1P3W-2 (Power + Harmonics)
<b>Max number of saved file</b>	3 * Number of times that you can start a measurement.
<b>Icon display</b>	When the internal memory is available, the  icon is displayed on the LCD during record.
<b>FULL indication</b>	The  icon blinks when saved data size or number of saved file exceeds the capacity. Data cannot be saved while this mark is being displayed. The instrument measures integration/ demand continuously, but does not record the data.

## 10. SPECIFICATION

SD card	
<b>Storage capacity</b>	2GB (Data storage capacity: 1.86 Gbyte)
<b>Max data size (2GB)</b>	14,623 byte/data (Max:1,271,964 data) *3P3W-2/1P3W-2(Power+ Harmonics)
<b>Max number of saved file (2GB)</b>	65536 * Number of times that you can start a measurement.
<b>Icon display</b>	When the SD card is available, the "  " icon is displayed on the LCD.
<b>Format (2GB)</b>	FAT16
<b>FULL indication</b>	The "  " icon blinks when saved data size or number of saved files exceeds the capacity. Data cannot be saved while this mark is being displayed. The instrument measures integration/ demand continuously, but does not record the data.

### 10.3 Measurement Specification

#### Measured Items and the Number of Analysis Points

Computed with 8192-point data while regarding 200ms(50Hz:10-cycle, 60Hz:12-cycle) as one measurement area.
Frequency, r.m.s. voltage/ current, active power, apparent power, reactive power, PF, Capacitance calc.
Computed with 2048-point data while regarding 200ms(50Hz:10-cycle, 60Hz:12-cycle) as one measurement area.
Voltage/current unbalance ratio, r.m.s. harmonics voltage/current (rate of content), harmonics reactive power, total harmonics voltage/ current distortion factor (THDV-F/R)/ (THDA-F/R), phase angle of harmonics voltage/ current, phase difference of harmonics voltage/ current.
Computed with 819-point data (50Hz), 682-point data (60Hz) while regarding one waveform overlapped every half wave as one measurement area.
Voltage dip, voltage swell, INT, Inrush current
Described based on inst values measured at 40.96ksp/s.
Voltage/ current waveform, External input voltage

## 10. SPECIFICATION

### Items Measured at Instantaneous Measurement

Frequency f [Hz]	
Displayed digit	4-digit
Accuracy	±2dgt (40.00Hz - 70.00Hz, V1 Range 10% - 110%, sine wave)
Display range	10.00 - 99.99Hz
Input source	V1 (fix)

10-sec average frequency f10 [Hz]	
Displayed digit	4-digit * e.g. averaged frequency values at 10 sec of intervals
Meas. system	Complied with IEC61000-4-30
Accuracy	±2dgt (40.00Hz - 70.00Hz, V1 Range 10% - 110%, sine wave)
Display range	10.00 - 99.99Hz
Input source	V1 (fix)

R.M.S. Voltage V [Vrms]	
Range	600.0/1000V
Displayed digit	4-digit
Effective input range	1% - 120% of Range (rms) and 200% of Range (peak)
Display range	0.15% - 130% of Range ("0" is displayed at less than 0.15%)
Crest factor	3 or less
Meas. system	Complied with IEC61000-4-30
Accuracy	Assuming that measuring 40-70Hz, sine wave at 600V Range: 10% - 150% against 100V or more of nominal V: Nominal V±0.5% Out of above range and at 1000V Range: ±0.2%rdg±0.2%f.s.
Input impedance	approx 1.67MΩ
Equation	$V_c = \sqrt{\left(\frac{1}{n} \left(\sum_{i=0}^{n-1} (V_{ci})^2\right)\right)}$ <p>i : sampling point* n: number of sampled values at 10 or 12-cycle c : Measurement channel</p> <p>* 50Hz: 8192 points in 10 waveforms, 60Hz: 8192 points in 12 waveforms</p>
1P2W-1 to 4	V <sub>1</sub>
1P3W-1 to 2	V <sub>1</sub> , V <sub>2</sub>
3P3W-1 to 2	Line voltage: $V_{12}, V_{23}, V_{31} = \sqrt{(V_{23}^2 + V_{12}^2 + 2 \times V_{23} \times V_{12} \times \cos\theta V)}$ <p>* θV=relative angles of V<sub>12</sub>, V<sub>23</sub></p>
3P3W3A	Line voltage: V <sub>12</sub> , V <sub>23</sub> , V <sub>31</sub>
3P4W	Phase voltage: V <sub>1</sub> , V <sub>2</sub> , V <sub>3</sub> Line voltage : $V_{12} = \sqrt{(V_1^2 + V_2^2 - 2 \times V_1 \times V_2 \times \cos\theta V_1)}$ $V_{23} = \sqrt{(V_2^2 + V_3^2 - 2 \times V_2 \times V_3 \times \cos\theta V_2)}$ $V_{31} = \sqrt{(V_3^2 + V_1^2 - 2 \times V_3 \times V_1 \times \cos\theta V_3)}$ <p>* θV<sub>1</sub> = relative angles of V<sub>1</sub>, V<sub>2</sub>, θV<sub>2</sub> = relative angles of V<sub>2</sub>, V<sub>3</sub>, θV<sub>3</sub> = relative angles of V<sub>3</sub>, V<sub>1</sub></p>

## 10. SPECIFICATION

R.M.S. Current A [Arms]	
Range	CT-500 (1000A): 100.0/1000A/AUTO CT-53 (3000A): 300.0/1000/3000A
Displayed digit	4-digit
Effective input range	1% - 110% of each Range (rms) and 200% of Range (peak)
Display range	0.15% - 130% of each range ("0" is displayed at less than 0.15%)
Crest factor	3 or less
Meas. system	Complied with IEC61000-4-30
Accuracy	Assuming that measuring 40-70Hz, sine wave: $\pm 0.2\% \text{rdg} \pm 0.2\% \text{f.s.} + \text{accuracy of clamp sensor}$
Input impedance	approx 100k $\Omega$
Equation	$A_c = \sqrt{\left(\frac{1}{n} \left(\sum_{i=0}^{n-1} (A_{ci})^2\right)\right)}$ <p>c : Measurement channel <math>A_1, A_2, A_3, A_4</math>            i : sampling point*            n : number of sampled values at 10 or 12-cycle</p> <p>* 50Hz: 8192 points in 10 waveforms, 60Hz: 8192 points in 12 waveforms</p> <p>* <math>A_3</math> value for 3P3W-1 to 2 is calculated with r.m.s. current values.  <math>A_3 = \sqrt{(A_1^2 + A_2^2 + 2 \times A_1 \times A_2 \times \cos\theta_A)}</math>  <i>relative angles of <math>\theta_A = A_1, A_2</math></i></p>

## 10. SPECIFICATION

Active power P [W]					
Range					
Current \ Voltage	CT-500		CT-53		
	1000V	1000A	100.0A	3000A	1000A
600.0V	1000k	100.0k	3000k	1000k	300.0k
	600.0k	60.00k	1800k	600.0k	180.0k

Displayed digit	4-digit
Accuracy	±0.3%rdg±0.2%f.s.+ accuracy of clamp sensor (PF 1, sine wave, 40-70Hz) *Sum values are total amounts of the used channels.
Influence of PF	±1.0%rdg (40Hz-70Hz, PF0.5)
Polarity	Consumption (flow-in):+( no sign), Regenerating( flow-out):-
Formula	$P_c = \frac{1}{n} \left( \sum_{i=0}^{n-1} (V_{ci} \times A_{ci}) \right)$ c: Measurement channel i: sampling point* n: number of sampled values * 50Hz: 8192 points in 10 waveforms, 60Hz: 8192 points in 12 waveforms
1P2W-1 to 4	$P_1, P_2, P_3, P_4, P_{sum}=P_1+P_2+P_3+P_4$
1P3W(3P3W)-1 to 2	$P_1, P_2, P_{sum1}=P_1+P_2$
	$P_3, P_4, P_{sum2}=P_3+P_4$
	$P_{sum}=P_{sum1}+P_{sum2}$
3P3W3A	$P_1, P_2, P_3, P_{sum}=P_1+P_2+P_3$ * Phase voltages are used.
3P4W	$P_1, P_2, P_3, P_{sum}=P_1+P_2+P_3$

External input voltage DCi [V]	
Range	100.0mV/ 1000mV/ 10.00V
Displayed digit	4-digit
Effective input range	1% - ±100% (DC) of each Range
Display range	0.3% - ±110% of each Range ("0" is displayed at less than 0.3%)
Accuracy	±0.5%f.s (DC)
Input impedance	Approx. 225.6kΩ
Saved item	External input voltage



## 10. SPECIFICATION

### Items to be Calculated

Apparent power S [VA]	
Range	Same as active power.
Displayed digit	Same as active power.
Accuracy	±1dgt against each calculated value (for sum : ±3dgt)
Sign	No polarity indication
Equation	$S_c = V_c \times A_c$ ; when $P_c > S_c$ , regarding $P_c = S_c$ . c: Measurement channel
1P2W-1 to 4	$S_1, S_2, S_3, S_4, S_{sum} = S_1 + S_2 + S_3 + S_4$
1P3W-1 to 2	$S_1, S_2, S_{sum1} = S_1 + S_2$
	$S_3, S_4, S_{sum2} = S_3 + S_4$
	$S_{sum} = S_{sum1} + S_{sum2}$
3P3W-2	$S_1, S_2, S_{sum1} = \sqrt{3/2} (S_1 + S_2)$
	$S_3, S_4, S_{sum2} = \sqrt{3/2} (S_3 + S_4)$
	$S_{sum} = S_{sum1} + S_{sum2}$
3P3W3A	$S_1, S_2, S_3, S_{sum} = S_1 + S_2 + S_3$ * Phase angles are used.
3P4W	$S_1, S_2, S_3, S_{sum} = S_1 + S_2 + S_3$

Reactive power Q [Var]	
Range	Same as active power.
Displayed digit	Same as active power.
Accuracy	±1dgt against each calculated value (for sum : ±3dgt)
Sign	- : leading phase (current phase against voltage) (no sign) + : lagging phase (current phase against voltage) Harmonics reactive power is calculated per ch, and the polarity sign of the reversed basic waveform is displayed.
Equation	$Q_c = sign \sqrt{S_c^2 - P_c^2}$ sign: Polarity sign , c: Measurement channel
1P2W-1 to 4	$Q_1, Q_2, Q_3, Q_4, Q_{sum} = Q_1 + Q_2 + Q_3 + Q_4$
1P3W(3P3W)-1 to 2	$Q_1, Q_2, Q_{sum1} = Q_1 + Q_2$
	$Q_3, Q_4, Q_{sum2} = Q_3 + Q_4$
	$Q_{sum} = Q_{sum1} + Q_{sum2}$
3P3W3A(3P4W)	$Q_1, Q_2, Q_3, Q_{sum} = Q_1 + Q_2 + Q_3$

## 10. SPECIFICATION

Power factor: PF	
Display range	-1.000 to 0.000 to 1.000
Accuracy	±1dgt against each calculated value (for sum : ±3dgt)
Sign	-: leading phase + (no sign): lagging phase Harmonics reactive power is calculated per ch, and the polarity sign of the reversed basic waveform is displayed.
Equation	$PF_c = sign \left  \frac{P_c}{S_c} \right $ sign: Polarity mark, c: Measurement channel
1P2W-1 to 4	$PF_1, PF_2, PF_3, PF_4, PF_{sum}$
1P3W(3P3W)-1 to 2	$PF_1, PF_2, PF_{sum1}$
	$PF_3, PF_4, PF_{sum2}$
	$PF_{sum}$
3P3W3A(3P4W)	$PF_1, PF_2, PF_3, PF_{sum}$

Neutral current An [A] * only when the wiring configuration is 3P4W.	
Range	Same as r.m.s. current.
Displayed digit	Same as r.m.s. current.
Display area	Same as r.m.s. current.
Equation	$A_n = \sqrt{\{A_1 + A_2 \cos(\theta_2 - \theta_1) + A_3 \cos(\theta_3 - \theta_1)\}^2 + \{A_2 \sin(\theta_2 - \theta_1) + A_3 \sin(\theta_3 - \theta_1)\}^2}$ * $\theta_{1,2,3}$ represent the phase differences between V1 and A1,2 and 3 respectively.

Voltage unbalance ratio Uunb [%]	
Displayed digit	5-digit
Display range	0.00% to 100.00%
Wiring	3P3W, 3P4W
Meas. system	Complied with IEC61000-4-30
Accuracy	±0.3%: at 50/60Hz, sine wave (between 0 to 5 % according to IEC61000-4-30)
Meas. system	Complied with IEC61000-4-30
Equation	$V_{umb} = \sqrt{\left( \frac{1 - \sqrt{3 - 6\beta}}{1 + \sqrt{3 - 6\beta}} \right)} \times 100 \quad \beta = \frac{V_{12}^4 + V_{23}^4 + V_{31}^4}{(V_{12}^2 + V_{23}^2 + V_{31}^2)^2}$ * The 1st order components of harmonic voltage are used. * For 3P4W system, phase voltages are converted to line voltages for calculation. $V_{12} = V_1 - V_2, V_{23} = V_2 - V_3, V_{31} = V_3 - V_1$

## 10. SPECIFICATION

Current unbalance ratio Aunb [%]	
Displayed digit	5-digit
Display range	0.00% to100.00%
Wiring	3P3W, 3P4W
Equation	$I_{umb} = \sqrt{\left(\frac{1 - \sqrt{(3-6\beta)}}{1 + \sqrt{(3-6\beta)}}\right)^2} \times 100 \quad \beta = \frac{A_{12}^4 + A_{23}^4 + A_{31}^4}{(A_{12}^2 + A_{23}^2 + A_{31}^2)^2}$ <p>* The 1st order components of harmonic current are used.            * For 3P4W system, phase voltages are converted to line voltages for calculation.  <math>A_{12} = A_1 - A_2, A_{23} = A_2 - A_3, A_{31} = A_3 - A_1</math></p>
Capacitance calculation	
Displayed digit	4-digit, Unit: nF, μF, mF, kvar
Display range	0.000nF - 9999F, 0.000kvar - 9999kvar
Equation	$C_c = P_c \times \left( \sqrt{\frac{1}{PF_c^2} - 1} - \sqrt{\frac{1}{PF_{c\_Target}^2} - 1} \right) [k \text{ var}]$ $= \frac{P_c \times 10^9}{2\pi f \times V_c^2} \times \left( \sqrt{\frac{1}{PF_c^2} - 1} - \sqrt{\frac{1}{PF_{c\_Target}^2} - 1} \right) [\mu F]$ <p> <math>C_c</math> : Capacitance needs for improvement  <math>P_c</math> : Load power (active power) [kW]  <math>f</math> : Frequency  <math>V_c</math> : R.m.s. voltage  <math>PF_c</math> : Measured PF  <math>PF_{c\_Target}</math> : New power factor (target)  <math>c</math> : Measurement channel         </p>
1P2W-1 to 4	$C_1, C_2, C_3, C_4, C_{sum} = C_1 + C_2 + C_3 + C_4$
1P3W(3P3W)-1 to 2	$C_1, C_2, C_{sum1} = C_1 + C_2$
	$C_1, C_2, C_{sum2} = C_3 + C_4$
	$C_{sum} = C_{sum1} + C_{sum2}$
3P3W3A(3P4W)	$C_1, C_2, C_3, C_{sum} = C_1 + C_2 + C_3$

## 10. SPECIFICATION

### Items Measured at Integration Measurement

Power consumption (if P≥0) Active power energy +WP [Wh]	
Displayed digit	6-digit, Unit: m, k, M, G, T (harmonized with + WS)
Display area	0.00000mWh - 9999.99TWh (harmonized with + WS) * "OL" is displayed when the display area is exceeded.
Equation	$+WP_C = \frac{1}{h} \left( \sum_i (+P_{ci}) \right)$
	h: integration period (3600 sec), c: Measurement channel, i: Data point no.
1P2W-1 to 4	+WP <sub>1</sub> , +WP <sub>2</sub> , +WP <sub>3</sub> , +WP <sub>4</sub> , +WP <sub>sum</sub>
1P3W(3P3W)-1 to 2	+WP <sub>1</sub> , +WP <sub>2</sub> , +WP <sub>sum1</sub>
	+WP <sub>3</sub> , +WP <sub>4</sub> , +WP <sub>sum2</sub>
	+WP <sub>sum</sub>
3P3W3A(3P4W)	+WP <sub>1</sub> , +WP <sub>2</sub> , +WP <sub>3</sub> , +WP <sub>sum</sub>

Apparent power energy +WS [VAh]	
Displayed digit	6-digit, Unit: m, k, M, G, T (harmonized with + WS)
Display area	0.00000mVAh - 9999.99TVAh (harmonized with + WS) * "OL" is displayed when the display area is exceeded.
Equation	$+WSC = \frac{1}{h} \left( \sum_i (S_{ci}) \right)$
	h: integration period (3600 sec), c: Measurement channel, i: Data point no.
1P2W-1 to 4	+WS <sub>1</sub> , +WS <sub>2</sub> , +WS <sub>3</sub> , +WS <sub>4</sub> , +WS <sub>sum</sub>
1P3W(3P3W)-1 to 2	+WS <sub>1</sub> , +WS <sub>2</sub> , +WS <sub>sum1</sub>
	+WS <sub>3</sub> , +WS <sub>4</sub> , +WS <sub>sum2</sub>
	+WS <sub>sum</sub>
3P3W3A(3P4W)	+WS <sub>1</sub> , +WS <sub>2</sub> , +WS <sub>3</sub> , +WS <sub>sum</sub>
Saved item	Apparent power energy

## 10. SPECIFICATION

Reactive power energy +WQ [Varh]	
Displayed digit	6-digit, Unit: m, k, M, G, T (harmonized with + WS)
Display area	0.00000mvarh - 9999.99Tvarh (harmonized with + WS) * "OL" is displayed when the display area is exceeded.
Equation	Leading phase $+WQ_{c\_c} = \frac{1}{h} \left( \sum_i (+Q_{ci}) \right)$
	Lagging phase $+WQ_{i\_c} = \frac{1}{h} \left( \sum_i (-Q_{ci}) \right)$
	h: integration period (3600 sec), n: System No., c: Measurement channel, i: Data point no. * where: Lagging phase: Q ≥ 0, Leading phase: Q < 0
1P2W-1 to 4	+WQ <sub>1</sub> , +WQ <sub>2</sub> , +WQ <sub>3</sub> , +WQ <sub>4</sub> , +WQ <sub>sum</sub>
1P3W(3P3W)-1 to 2	+WQ <sub>1</sub> , +WQ <sub>2</sub> , +WQ <sub>sum1</sub>
	+WQ <sub>3</sub> , +WQ <sub>4</sub> , +WQ <sub>sum2</sub>
	+WQ <sub>sum</sub>
3P3W3A(3P4W)	+WQ <sub>1</sub> , +WQ <sub>2</sub> , +WQ <sub>3</sub> , +WQ <sub>sum</sub>
Regenerating power (where: P<0) Active power energy - WP[Wh]	
Displayed digit	6-digit, Unit: m, k, M, G, T (harmonized with + WS)
Display area	0.00000mVAh - 9999.99TVAh (harmonized with + WS) * "OL" is displayed when the display area is exceeded.
Equation	$-WPC = \frac{1}{h} \left( \sum_i (-P_{ci}) \right)$
	h: integration period (3600 sec), c: Measurement channel, i: Data point no.
1P2W-1 to 4	-WP <sub>1</sub> , -WP <sub>2</sub> , -WP <sub>3</sub> , -WP <sub>4</sub> , -WP <sub>sum</sub>
1P3W(3P3W)-1 to 2	-WP <sub>1</sub> , -WP <sub>2</sub> , -WP <sub>sum1</sub>
	-WP <sub>3</sub> , -WP <sub>4</sub> , -WP <sub>sum2</sub>
	-WP <sub>sum</sub>
3P3W3A(3P4W)	-WP <sub>1</sub> , -WP <sub>2</sub> , -WP <sub>3</sub> , -WP <sub>sum</sub>

## 10. SPECIFICATION

Apparent power energy -WS[VAh]	
Displayed digit	6-digit, Unit: m, k, M, G, T (harmonized with + WS)
Display area	0.00000mVAh - 9999.99TVAh (harmonized with + WS) * "OL" is displayed when the display area is exceeded.
Equation	$-WS_c = \frac{1}{h} \left( \sum_i (S_{ci}) \right)$
	h: integration period (3600 sec), c: Measurement channel, i: Data point no.
1P2W-1 to 4	-WS <sub>1</sub> , -WS <sub>2</sub> , -WS <sub>3</sub> , -WS <sub>4</sub> , -WS <sub>sum</sub>
1P3W(3P3W)-1 to 2	-WS <sub>1</sub> , -WS <sub>2</sub> , -WS <sub>sum1</sub>
	-WS <sub>3</sub> , -WS <sub>4</sub> , -WS <sub>sum2</sub>
	-WS <sub>sum</sub>
3P3W3A(3P4W)	-WS <sub>1</sub> , -WS <sub>2</sub> , -WS <sub>3</sub> , -WS <sub>sum</sub>

Reactive power energy -WQ [Varh]	
Displayed digit	6-digit, Unit: m, k, M, G, T (harmonized with + WS)
Display area	0.00000mvarh - 9999.99Tvarh (harmonized with + WS) * "OL" is displayed when the display area is exceeded.
Equation	Leading phase $-WQ_{c\_c} = \frac{1}{h} \left( \sum_i (+Q_{ci}) \right)$
	Leading phase $-WQ_{i\_c} = \frac{1}{h} \left( \sum_i (-Q_{ci}) \right)$
	h: integration period (3600 sec), n: System No., c: Measurement channel, i: Data point no. * where: Lagging phase: Q ≥ 0, Leading phase: Q < 0
1P2W-1 to 4	-WQ <sub>1</sub> , -WQ <sub>2</sub> , -WQ <sub>3</sub> , -WQ <sub>4</sub> , -WQ <sub>sum</sub>
1P3W(3P3W)-1 to 2	-WQ <sub>1</sub> , -WQ <sub>2</sub> , -WQ <sub>sum1</sub>
	-WQ <sub>3</sub> , -WQ <sub>4</sub> , -WQ <sub>sum2</sub>
	-WQ <sub>sum</sub>
3P3W3A(3P4W)	-WQ <sub>1</sub> , -WQ <sub>2</sub> , -WQ <sub>3</sub> , -WQ <sub>sum</sub>

Duration of integration	
Display area	00:00:00 (0 sec) - 99:59:59 (99 h 59 min 59 sec) , 0100:00 - 9999:59 (9999 h 59 min) , 010000 - 999999 (999999 h) * Displayed time will transit in series.

## 10. SPECIFICATION

### Items Measured at Demand Measurement

Target value ( $DEM_{Target}$ )	
Displayed digit	4-digit
Unit	m, k, M, G, T
Display range	0.000mW(VA) - 999.9TW(VA) *according to the selected values

Predicted value ( $DEM_{Guess}$ )	
Displayed digit	6-digit
Unit	m, k, M, G, T (depending on $DEM_{Target}$ value)
Display range	0.00000mW(VA) - 99999.9TW(VA) * Decimal point is dependent on the $DEM_{Target}$ . * "OL" is displayed when the display area is exceeded.
Equation	$DEM_{Guess} = \Sigma DEM \times \frac{Demand \ interval}{Elapsed \ time}$

Present value, Measured demand value ( $\Sigma DEM$ )	
Displayed digit	6-digit , Unit: m, k, M, G, T (depending on $DEM_{Target}$ value)
Unit	m, k, M, G, T (depending on $DEM_{Target}$ value)
Display range	0.00000mW(VA) - 99999.9TW(VA) * Decimal point is dependent on the $DEM_{Target}$ . * "OL" is displayed when the display area is exceeded.
Equation	$\Sigma DEM = \left( \text{Integration values of "WPsum (+WSsum)"} \right) \times \frac{1 \ hour}{Interval}$

Load factor	
Displayed digit	6-digit
Display range	0.00 - 9999.99% * "OL" is displayed when the display area is exceeded.
Equation	$\frac{\Sigma DEM}{DEM_{Target}}$

Estimation	
Displayed digit	6-digit
Display range	0.00 - 9999.99% * "OL" is displayed when the display area is exceeded.
Equation	$\frac{DEM_{Guess}}{DEM_{Target}}$

## 10. SPECIFICATION

### Items Measured at Harmonics Measurement

<b>Meas. system</b>	Digital PLL synchronization
<b>Meas. method</b>	Analyze harmonics, and then add and display the inter-harmonics components adjacent to the integral order of the analyzed harmonics
<b>Effective frequency range</b>	40 - 70Hz
<b>Order analysis</b>	1 - 50th
<b>Window width</b>	10-cycle at 50Hz, 12-cycle at 60Hz
<b>Window type</b>	Rectangular
<b>Data analysis</b>	2048 points
<b>Analyzing rate</b>	once/ 200ms at 50Hz/60Hz

<b>R.m.s. harmonics voltage <math>V_k</math> [Vrms]</b>	
<b>Range</b>	Same as r.m.s. voltage
<b>Displayed digit</b>	Same as r.m.s. voltage
<b>Display range</b>	Same as r.m.s. voltage * rate of content 0.0% - 100.0%, percentage against the basic wave
<b>Accuracy</b>	Complied with IEC61000-2-4 Class3 where 10% - 100% of input range for 600V Range. 3% or more against 100V of nominal voltage: $\pm 10\%rdg$ Less than 3% against 100V of nominal voltage: nominal voltage $\pm 0.3\%$ 1000V Range: $\pm 0.2\%rdg \pm 0.2\%f.s.$
<b>Equation</b>	$V_{ck} = \sqrt{\sum_{n=1}^k (V_c(10k+n)_r)^2 + (V_c(10k+n)_i)^2}$ <p>Rate of content = <math>\frac{V_{ck} \times 100}{V_{c1}}</math></p> <p>c: Measurement channel, k: Harmonics of each order            Vr: Real number after Voltage FFT conversion            Vi: Imaginary number after Voltage FFT conversion            Measurement cycle in this equation is 10-cycle. For 12-cycle measurement, "10k+n" should be replaced with "12k+n".</p>
<b>1P2W-1 to 4</b>	$V_{1k}$
<b>1P3W-1 to 2</b>	$V_{1k}, V_{2k}$
<b>3P3W-1 to 2</b>	Line voltage $V_{12k}, V_{32k}$
<b>3P3W3A</b>	Line voltage $V_{12k}, V_{23k}, V_{31k}$
<b>3P4W</b>	$V_{1k}, V_{2k}, V_{3k}$



## 10. SPECIFICATION

R.m.s. harmonics current Ak [Arms]	
Range	Same as r.m.s. current
Displayed digit	Same as r.m.s. current
Display range	Same as r.m.s. current * Rate of content: 0.0% - 100.0% (percentages to the basic wave)
Meas. system	Complied with IEC61000-4-7, IEC61000-2-4 Analysis window width: 10/12 cycle for 50/60Hz, Measured values contain the inter-harmonics adjacent to the analyzed orders' harmonics
Accuracy	Meets the accuracy specified in IEC61000-2-4 Class3 at 10% - 100% of the input range of the measurement range. 10% or more to max. input range: $\pm 10\%rdg + \text{Accuracy of Clamp sensor}$ Less than 10% to max. input range: $\text{max value of the range} \pm 1.0\% + \text{Accuracy of Clamp sensor}$
Equation	$A_{ck} = \sqrt{\sum_{n=1}^i (A_c(10k+n)r)^2 + (A_c(10k+n)i)^2}$ Rate of content = $\frac{A_{ck} \times 100}{A_{c1}}$ c: Measurement channel: A1k, A2k, A3k, A4k. k: Harmonics of each order. r: Real number after FFT conversion. i: Imaginary number after FFT conversion. Measurement cycle in this equation is 10-cycle. For 12-cycle measurement, "10k+n" should be replaced with "12k+n".

Harmonics power Pk [W]	
Range	Same as active power
Displayed digit	Same as active power
Display range	Same as active power * rate of content 0.0% - 100.0%, percentage against the absolute value of basic wave
Meas. system	Complied with IEC61000-4-7
Accuracy	$\pm 0.3\%rdg \pm 0.2\%f.s. + \text{accuracy of clamp sensor (PF 1, sine wave: 50/60Hz)}$ (Sum represents the total values obtained through the used channels.)
Equation	$P_{Ck} = V_{c(10k)r} \times A_{c(10k)r} - V_{c(10k)i} \times A_{c(10k)i}$ Rate of content = $\frac{P_{ck} \times 100}{P_{c1}}$ c: Measurement channel, k: Harmonics of each order. r: Real number after FFT conversion. i: Imaginary number after FFT conversion. Measurement cycle in this equation is 10-cycle. For 12-cycle measurement, "10k" should be replaced with "12k".
1P2W-1 to 4	$P_{1k}, P_{2k}, P_{3k}, P_{4k}, P_{sumk} = P_{1k} + P_{2k} + P_{3k} + P_{4k}$
1P3W-1 to 2	$P_{1k}, P_{2k}, P_{sum1k} = P_{1k} + P_{2k}$
	$P_{3k}, P_{4k}, P_{sum2k} = P_{3k} + P_{4k}$
	$P_{sumk} = P_{sum1k} + P_{sum2k}$
3P3W-1 to 2	$P_{1k}, P_{2k}, P_{sum1k} = P_{1k} + P_{2k}$
	$P_{3k}, P_{4k}, P_{sum2k} = P_{3k} + P_{4k}$
	$P_{sumk} = P_{sum1k} + P_{sum2k}$
3P3W3A	Phase voltage $P_{1k}: V_1 = (V_{12} - V_{31})/3, P_{2k}: V_2 = (V_{23} - V_{12})/3,$ $P_{3k}: V_3 = (V_{31} - V_{23})/3, P_{sumk} = P_{1k} + P_{2k} + P_{3k}$
3P4W	$P_{1k}, P_{2k}, P_{3k}, P_{sumk} = P_{1k} + P_{2k} + P_{3k}$

## 10. SPECIFICATION

Harmonics reactive power Qk [var] (used for internal calculation only)	
Equation	$P_{ck} = V_{c(10k)r} \times A_{c(10k)i} - V_{c(10k)i} \times A_{c(10k)r}$ <p>c: Measurement channel: A1k, A2k, A3k, A4k, k: Harmonics of each order.                      r: Real number after FFT conversion.                      i: Imaginary number after FFT conversion.                      Measurement cycle in this equation is 10-cycle. For 12-cycle measurement, "10k" should be replaced with "12k".</p>
1P2W-1 to 4	$Q_{1k}Q_{2k}, Q_{3k}, Q_{4k}, Q_{sumk} = Q_{1k} + Q_{2k} + Q_{3k} + Q_{4k}$
1P3W-1 to 2	$Q_{1k}, Q_{2k}, Q_{sum1k} = Q_{1k} + Q_{2k}$
	$Q_{3k}, Q_{4k}, Q_{sum2k} = Q_{3k} + Q_{4k}$
	$Q_{sumk} = Q_{sum1k} + Q_{sum2k}$
3P3W-1 to 2	$Q_{1k}, Q_{2k}, Q_{sum1k} = Q_{1k} + Q_{2k}$
	$Q_{3k}, Q_{4k}, Q_{sum2k} = Q_{3k} + Q_{4k}$
	$Q_{sumk} = Q_{sum1k} + Q_{sum2k}$
3P3W3A	Phase voltage $Q_{1k}: V_1 = (V_{12} - V_{31})/3, Q_{2k}: V_2 = (V_{23} - V_{12})/3, Q_{3k}: V_3 = (V_{31} - V_{23})/3, Q_{sumk} = Q_{1k} + Q_{2k} + Q_{3k}$
3P4W	$Q_{1k}, Q_{2k}, Q_{3k}, Q_{sumk} = Q_{1k} + Q_{2k} + Q_{3k}$

Harmonics voltage total distortion factor THDVF [%]	
Displayed digit	4-digit
Display range	0.0% - 100.0%
Equation	$THDVF_c = \frac{\sqrt{\sum_{k=2}^{50} (V_{ck})^2} \times 100}{V_{c1}}$ <p>c: Meas. channel                      V: Harmonics voltage                      k: Harmonics of each order</p>
1P2W-1 to 4	$THDVF_1$
1P3W-1 to 2	$THDVF_1, THDVF_2$
3P3W-1 to 2	Line voltage $THDVF_{12}, THDVF_{32}$
3P3W3A	Line voltage $THDVF_{12}, THDVF_{23}, THDVF_{31}$
3P4W	$THDVF_1, THDVF_2, THDVF_3$

Harmonics current total distortion factor THDAF [%]	
Displayed digit	4-digit
Display range	0.0% - 100.0%
Equation	$THDAF_c = \frac{\sqrt{\sum_{k=2}^{50} (A_{ck})^2} \times 100}{A_{c1}}$ <p>c: Meas. ch <math>THDAF_1, THDAF_2, THDAF_3, THDAF_4</math>                      A: Harmonics current                      k: Harmonics of each order</p>

## 10. SPECIFICATION

Harmonics voltage total distortion factor THDVR [%]	
Displayed digit	4-digit
Display range	0.0% - 100.0%
Equation	$THDVR_c = \frac{\sqrt{\sum_{k=2}^{50} (V_{ck})^2} \times 100}{\sqrt{\sum_{k=1}^{50} (V_{ck})^2}}$ <p>c: Meas. channel V: Harmonics voltage k: Harmonics of each order</p>
1P2W-1 to 4	$THDVF_1$
1P3W-1 to 2	$THDVF_1, THDVF_2$
3P3W-1 to 2	Line voltage $THDVF_{12}, THDVF_{32}$
3P3W3A	Line voltage $THDVF_{12}, THDVF_{23}, THDVF_{31}$
3P4W	$THDVF_1, THDVF_2, THDVF_3$

Harmonics current total distortion factor THDAR [%]	
Displayed digit	4-digit
Display range	0.0% - 100.0%
Equation	$THDAR_c = \frac{\sqrt{\sum_{k=2}^{50} (A_{ck})^2} \times 100}{\sqrt{\sum_{k=1}^{50} (A_{ck})^2}}$ <p>c: Meas. ch <math>THDAF_1, THDAF_2, THDAF_3, THDAF_4</math> A: Harmonics current k: Harmonics of each order</p>

Harmonics voltage phase angle $\theta V_k$ [deg]	
Displayed digit	4-digit
Display range	0.0% - 100.0%
Equation	$\theta V_{ck} = \tan^{-1} \left\{ \frac{V_{ckr}}{-V_{cki}} \right\}$ <p>c: Measurement channel V: Harmonics voltage k: Harmonics of each order r: Real number after FFT conversion, i: Imaginary number after FFT conversion</p>
1P2W-1 to 4	$\theta V_{1k}$
1P3W-1 to 2	$\theta V_{1k}, \theta V_{2k}$
3P3W-1 to 2	$\theta V_{12k}, \theta V_{32k}$ * Line voltages are used.
3P3W3A	$\theta V_{12k}, \theta V_{23k}, \theta V_{31k}$ * Line voltages are used.
3P4W	$\theta V_{1k}, \theta V_{2k}, \theta V_{3k}$

## 10. SPECIFICATION

Total harmonics current phase angle $\theta_{Ak}$ [deg]	
Displayed digit	4-digit
Display range	0.0° to $\pm 180.0^\circ$
Equation	$\theta_{Ack} = \tan^{-1} \left\{ \frac{A_{ckr}}{-A_{cki}} \right\}$ <p>c: Measurement channel  <math>\theta_{A1k}, \theta_{A2k}, \theta_{A3k}, \theta_{A4k}</math>  A: Harmonics current  k: Harmonics of each order  r: Real number after FFT conversion,  i: Imaginary number after FFT conversion</p>

Harmonics voltage current phase angle difference $\theta_k$ [deg]	
Displayed digit	4-digit
Display range	0.0° to $\pm 180.0^\circ$
Equation	$\theta_k = \theta_{Ack} - \theta_{Vck}$ <p>c: Measurement channel, k: Harmonics of each order</p>
1P2W-1 to 4	$\theta_{1k}, \theta_{2k}, \theta_{3k}, \theta_{4k}, \theta_{sumk} = \tan^{-1} \left\{ \frac{Q_{sumk}}{P_{sumk}} \right\}$
1P3W(3P3W)-1 to 2	$\theta_{1k}, \theta_{2k}, \theta_{sum1k} = \tan^{-1} \left\{ \frac{Q_{sum1k}}{P_{sum1k}} \right\}$
	$\theta_{3k}, \theta_{4k}, \theta_{sum2k} = \tan^{-1} \left\{ \frac{Q_{sum2k}}{P_{sum2k}} \right\}$
	$\theta_{sumk} = \tan^{-1} \left\{ \frac{Q_{sumk}}{P_{sumk}} \right\}$
3P3W3A(3P4W)-1	$\theta_{1k}, \theta_{2k}, \theta_{3k}, \theta_{sumk} = \tan^{-1} \left\{ \frac{Q_{sumk}}{P_{sumk}} \right\}$

## 10. SPECIFICATION

### Items Measured at Power Quality Measurement

Voltage transient	
Meas. system	Approx. 40.96ksps (every 24 $\mu$ s) gapless event detection (50Hz/60Hz)
Displayed digit	4-digit
Effective input range	50V - 2200V (DC)
Display range	50V - 2200V (DC)
Accuracy	0.5%rdg * at 1000V (DC)
Input impedance	Approx. 1.67M $\Omega$
Threshold value	Absolute peak voltage value
Detection channel (ch)	
1P2W-1 to 4	$V_1$
1P3W-1 to 2	$V_1, V_2$
3P3W-1 to 2	Line voltage $V_{12}, V_{32}$
3P3W3A	Line voltage $V_{12}, V_{23}, V_{31}$
3P4W	$V_1, V_2, V_3$
Voltage swell, Dip, INT	
Range	Same as r.m.s. voltage
Displayed digit	Same as r.m.s. voltage
Effective input range	Same as r.m.s. voltage
Display range	Same as r.m.s. voltage
Crest factor	Same as r.m.s. voltage
Input impedance	Same as r.m.s. voltage
Threshold value	Percentage of the nominal voltage value
Meas. system	<p>Complied with IEC61000-4-3 *r.m.s. values are calculated from one waveform with half-wave overlapping.</p> <p>Swell, dip detection for multi-phase system: Starts when any one of events starts at any ch. Ends when it terminates.</p> <p>INT detection for multi-phase system: Starts when the event starts at all chs. Ends when it terminates at any one of the chs.</p>
Accuracy	<p>10% - 150% (to 100V or higher nominal voltages): nominal voltage <math>\pm 1.0\%</math></p> <p>Out of above range: <math>\pm 0.4\%</math>rdg<math>\pm 0.4\%</math>f.s.</p> <p>Errors of event duration measurement at 40 - 70Hz: within 1-cycle</p>
Detection channel (ch)	
1P2W-1 to 4	$V_1$
1P3W-1 to 2	$V_1, V_2$
3P3W-1 to 2	Line voltage $V_{12}, V_{32}$
3P3W3A	Line voltage $V_{12}, V_{23}, V_{31}$
3P4W	$V_1, V_2, V_3$

## 10. SPECIFICATION

---

### Inrush current

<b>Meas. system</b>	Same as r.m.s. current
<b>Displayed digit</b>	Same as r.m.s. current
<b>Effective input range</b>	Same as r.m.s. current
<b>Display range</b>	Same as r.m.s. current
<b>Crest factor</b>	Same as r.m.s. current
<b>Input impedance</b>	Same as r.m.s. current
<b>Threshold value</b>	Percentage of the measurement range
<b>Meas. system</b>	Calculate r.m.s. values from one waveform with half-wave overlapping.
<b>Accuracy</b>	$\pm 0.4\% \text{rdg} \pm 0.4\% \text{f.s.}$ + accuracy of clamp sensor
<b>Detection channel (ch)</b>	$A_1, A_2, A_3, A_4$

## 10. SPECIFICATION

### Flicker

<b>Displayed items</b>	Time left: Counted down time until a Pst calculation completes. V: r.m.s. voltage per half-wave, 1 sec average Pst(1min): Flicker value for 1 min (Pst ref. value) Pst: Severity of short term flicker (10 min) Plt: Severity of long term flicker (2 hours) Max Pst: Max value of Pst, and time information Max Plt: Max value of Plt, and time information Pst(1min) Latest trend graph (for the recent 120 min) Plt trend graph for the recent 600 hours
<b>Displayed digit</b>	4-digit, Resolution: log 0.001 - 6400 P.U. in 1024-split
<b>Ramp model</b>	230VRamp/220VRamp/120VRamp/100VRamp
<b>Meas. method</b>	Complied with IEC61000-4-30 and IEC61000-4-15 Ed.2
<b>Accuracy</b>	Pst (max. 20):±10%rdg according to the test method defined by IEC61000-4-15 Ed.2
<b>Equation</b> $Pst(1min)_c, Pst_c =$ $\sqrt{0.0314 \times P_{0.1} + 0.0525 \times P_{1S} + 0.0657 \times P_{3S} + 0.28 \times P_{10S} + 0.08 \times P_{50S}}$ $V_{1S} = (P_{0.7} + P_{1.5})/3, V_{3S} = (P_{2.2} + P_3 + P_4)/3, V_{10S} = (P_6 + P_8 + P_{10} + P_{13} + P_{17})/5,$ $V_{50S} = (P_{30} + P_{50} + P_{80})/3$ c: Measurement channel The 10-min* measurement data is classified into 1024 classes (0 - 6400P.U.), using the non-linear classification, to determine the cumulative probability function (CPF). It will be then corrected by the non-linear interpolating method, and do the calculation with the smoothed values. * Pst(1min): 1 min	
$Plt_c = 3 \times \sqrt{\frac{\sum_{i=1}^N Pst_i^3}{N}}$ c: Measurement channel, N:12 times(2-hour meas.)	
<b>1P2W-1 to 4</b>	$Pst(1min)_1, Pst_1, Plt_1$
<b>1P3W-1 to 2</b>	$Pst(1min)_1, Pst_1, Plt_1, Pst(1min)_2, Pst_2, Plt_2$
<b>3P3W-1 to 2</b>	Line voltage $Pst(1min)_{12}, Pst_{12}, Plt_{12}, Pst(1min)_{32}, Pst_{32}, Plt_{32}$
<b>3P3W3A</b>	Line voltage $Pst(1min)_{12}, Pst_{12}, Plt_{12}, Pst(1min)_{23}, Pst_{23},$ $Plt_{23}, Pst(1min)_{31}, Pst_{31}, Plt_{31}$
<b>3P4W</b>	$Pst(1min)_1, Pst_1, Plt_1, Pst(1min)_2, Pst_2, Plt_2, Pst(1min)_3, Pst_3, Plt_3$

# 10. SPECIFICATION

## 10.4 Specifications of Clamp Sensor

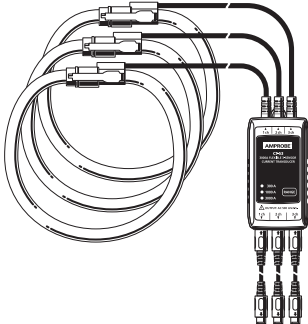
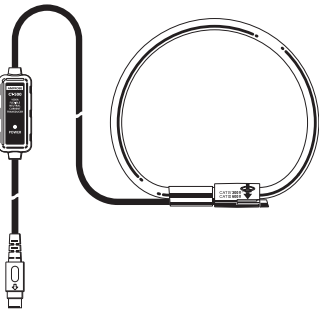
	CT-53	CT-500
		
<b>Rated current</b>	300A Range: AC 300 Arms( 424Apeak) 1000A Range: AC 1000 Arms(1414Apeak) 3000A Range: AC 3000 Arms(4243Apeak)	AC 1000 Arms(1850Apeak)
<b>Output voltage</b>	300A Range: AC0 - 500mV(AC500mV/AC300A): 1.67mV/A 1000A Range: AC0- 500mV(AC500mV AC1000A): 0.5mV/A 3000A Range: AC0-500mV(AC500mV/AC3000A): 0.167mV/A	AC0 - 500mV (AC500mV/AC1000A):0.5mV/A
<b>Measuring range</b>	300A Range: 30 - 300Arms 1000A Range: 100 - 1000Arms 3000A Range: 300 - 3000Arms	AC0 - 1000Arms
<b>Accuracy</b> (sine wave input)	$\pm 1.0\% \text{rdg}$ (45 - 65Hz) (at the center point)	$\pm 0.5\% \text{rdg} \pm 0.2\text{mV}$ (45 - 65Hz) $\pm 1.5\% \text{rdg} \pm 0.4\text{mV}$ (40Hz - 1kHz)
<b>Phase characteristics</b>	within $\pm 1.0^\circ$ (in each measuring range: 45 - 65Hz)	within $\pm 2.0^\circ$ (45 - 65Hz) within $\pm 3.0^\circ$ (40 - 1kHz)
<b>Temp. &amp; humidity range</b> (guaranteed accuracy)	23 $\pm$ 5 $^\circ$ C, relative humidity 85% or less (no condensation)	
<b>Operating temp.</b>	-10 - 50 $^\circ$ C, relative humidity 85% or less (no condensation)	
<b>Storage temp. range</b>	-20 to 60 $^\circ$ C, relative humidity 85% or less (no condensation)	
<b>Allowable input</b>	AC3600Arms (50/60Hz)	AC1300Arms (50/60Hz)



## 10. SPECIFICATION

	CT-53	CT-500
<b>Output impedance</b>	Approx. 100Ω or less	
<b>Location for use</b>	In-door use, altitude 2000m or less	
<b>Applicable standards</b>	IEC 61010-1, IEC 61010-2-032 Meas. CAT. III (600V) Pollution degree 2 IEC61326	IEC 61010-1, IEC 61010-2-032 Meas. CAT. III (600V)/CAT.IV (300V) Pollution degree 2 IEC61326
<b>Withstand voltage</b>	AC5350V/5 sec Between circuit – sensor	AC5160V/5 sec Between circuit – sensor
<b>Insulation resistance</b>	50MΩ or more/ 1000V Between circuit – sensor	
<b>Max conductor size</b>	Approx. ø150mm (max)	Approx. ø110mm (max.)
<b>Dimension</b>	111(L)×61(W)×43(D)mm (protrusions are not included)	65(L)×25(W)×22(D)mm
<b>Cable length</b>	Sensor part: Approx. 2m Output cable: Approx. 1m	Sensor part: Approx. 2.7m Output cable: Approx.0.2m
<b>Output terminal</b>	MINI DIN 6PIN	
<b>Weight</b>	CT-53: Approx.950g	Approx.170g
<b>Accessory</b>	Instruction manual, Output cable	Instruction manual, Cable marker,

# 11. TROUBLESHOOTING

## 11.1 General Troubleshooting

When defect or breakdown of the instrument is suspected, check the following points first. If your problem is not listed in this section, contact your local Amprobe distributor.

Symptom	Check
Instrument cannot be powered on. (Nothing is displayed on the LCD.)	<p><u>When operating with an AC power supply:</u></p> <ul style="list-style-type: none"> <li>• Power cord is connected firmly and properly?</li> <li>• No break in the Power cord?</li> <li>• Supply voltage is within the allowable range?</li> </ul> <p><u>When operating with batteries:</u></p> <ul style="list-style-type: none"> <li>• Batteries are installed with correct polarity position?</li> <li>• Size AA Ni-HM batteries have full-charge?</li> <li>• Size AA Alkaline batteries are not exhausted?</li> </ul> <p><u>If the problem is not solved yet:</u></p> <ul style="list-style-type: none"> <li>• Disconnect the power cord from an AC power source, and then remove all the batteries from the instrument. Insert the batteries again and connect the power cord to an AC power source. Power on the instrument. If the instrument still does not turn on, instrument failure may be suspected.</li> </ul>
Any key doesn't work.	<ul style="list-style-type: none"> <li>• Key lock function is inactivated?</li> <li>• Check the effective Keys on each Range.</li> </ul>
Readings are not stable or Inaccurate.	<ul style="list-style-type: none"> <li>• Frequency at voltage ch1 is within the guaranteed accuracy range? It should be between 40 and 70Hz.</li> <li>• Voltage test leads and clamp sensors are connected properly?</li> <li>• Setting of the instrument and the selected wiring configuration are appropriate?</li> <li>• Proper sensors are used with proper settings?</li> <li>• There is no break in the voltage test leads?</li> <li>• Input signal is not interfered?</li> <li>• Strong electric magnetic field does not exist in close proximity?</li> <li>• Measurement environment meets the specification of this instrument?</li> </ul>
Incapable of saving data to the internal memory.	<ul style="list-style-type: none"> <li>• Check the number of files in the memory.</li> <li>• If an SD card is inserted in the instrument, remove the card.</li> </ul>
Data cannot be saved on the SD card.	<ul style="list-style-type: none"> <li>• Ensure the SD card is inserted correctly.</li> <li>• Ensure the SD card has been formatted.</li> <li>• Ensure there is available free space on the SD card.</li> <li>• Check the max number of files or capacity of the SD card.</li> <li>• Ensure the SD card is operating properly.</li> <li>• Verify the proper operation of the SD card on other well-known hardware.</li> </ul>

## 11. TROUBLESHOOTING

Symptom	Check
Download and settings cannot be done via USB communication.	<ul style="list-style-type: none"> <li>• Check the connection of the USB cable between the instrument and PC.</li> <li>• Run the communication application software “Windows for DM-5” and check whether the connected devices are displayed or not. If the devices are not displayed, the USB driver might not be installed correctly. Please refer to the installation manual for “Windows for DM-5” and re-install the USB driver.</li> </ul>
“NG” judgment frequently appears during self-diagnosis.	If “NG” is given for “SD Card”, see the check points for “Data cannot be saved in the SD card.” in above column. If “NG” is give for other items, disconnect the power cord from an AC power source, and then remove all the batteries from the instrument. Insert the batteries again, and connect the power cord to an AC power source, and carry out the self-diagnosis again. If “NG” is still given, instrument failure may be suspected.

### 11.2 Error Messages and Actions

Error message may appear on the LCD while using the instrument. Please check the following table if any error message appears, and take action

Message	Detail & Action
No SD card.	<ul style="list-style-type: none"> <li>• Check the SD card is inserted correctly. See “<b>4.3 Placing/removing SD card</b>”.</li> </ul>
Check the amount of free space in the SD card.	
Check the amount of free space in the SD card.	<ul style="list-style-type: none"> <li>• Check the free space on the SD card. If the space is not enough, delete unnecessary files, format the card or use another card. The SD card should be formatted on the DM-5, not on a PC. See “<b>To delete, transfer or format the recorded data</b>”.</li> </ul>
Failed to detect sensors. Check the connection of the sensor(s).	<ul style="list-style-type: none"> <li>• Check the connection of current sensor.</li> <li>• If any problem is suspected, please do the following checks. Connect the current sensor, for which “NG” is given, to the CH on which another sensor is properly detected. If the result “NG” is given for the same CH, a defect of the instrument is suspected. A defect of sensor is suspected if “NG” is given for the same sensor connected to another CH. If NG result is given, stop using the instrument or the sensor.</li> </ul>
Battery level is low. Powering off...	<ul style="list-style-type: none"> <li>• Connect the instrument to an AC power source, or replace the batteries with new ones. * Size AA Alkaline battery (LR6) or fully-charged Size AA Ni-MH battery x 6pcs See “<b>How to install batteries</b>”.</li> </ul>
Not having free space on the internal memory. Format the memory or delete unnecessary files.	<ul style="list-style-type: none"> <li>• Check the free space on the internal memory and the total number of saved files. Max number of files that can be saved on the memory is: 3 for measurement data and 8 for the other data. If the free space is not enough, delete unnecessary files, format the memory. See “<b>To delete, transfer or format the recorded data</b>”.</li> </ul>

## 11. TROUBLESHOOTING

Message	Detail & Action
Cannot read the setting file. The file may be damaged.	<ul style="list-style-type: none"> <li>• Try again. If still the setting files are not read; there may be a problem with the SD card or the DM-5. If the setting files are on the SD card, the SD card may be the issue. If the setting files are on the internal memory, the DM-5 may be the issue. If a problem with the DM-5 is suspected, stop using the instrument.</li> </ul>
Available memory is low. Check the amount of free space in the SD card and internal memory.	<ul style="list-style-type: none"> <li>• Check the free space and the number of saved files on the SD card and the internal memory. Max number of the file that can be saved on the memory is: 3 for measurement data and 8 for the other data. If the space is not enough, delete unnecessary files, format the card or memory. When using another SD card, it should be formatted on the DM-5, not on the PC. See <b>"To delete, transfer or format the recorded data"</b>.</li> </ul>
There is no available space in the storage area.	
Start time is set in the past. Check the recording start method.	<ul style="list-style-type: none"> <li>• REC Start is either "Constant rec. / Time period rec." and the time set for REC End is set to the past. Check and modify the time and date. See <b>"(8)/ (9) Setting for recording method"</b>.</li> </ul>
Failed to start recording.	<ul style="list-style-type: none"> <li>• Check the "Recording setting" at SET UP menu. See <b>"5.4 Recording setting"</b>.</li> <li>• Try again. If still a record does not start, there may be a problem with either the SD card or the internal memory. Check which is set as the destination to save the data. If the destination is internal memory, a problem with the DM-5 may be the issue. Stop using the instrument in this case.</li> </ul>
Cannot change the instrument settings during recording or in stand-by mode.	<ul style="list-style-type: none"> <li>• Change of setting is not allowed during a record. To change the settings, stop record and confirm "Recording stopped." message appears and then disappears.</li> </ul>
New sensor is detected. Recheck the basic setting for SET UP before measurements	<ul style="list-style-type: none"> <li>• The connected clamp sensors are not the same ones used during the previous test. Modify the settings of clamp sensor directly from the "Basic setting" or press the "Detect" key.</li> </ul>
Sensor connection is not correct. Check the connected sensor(s).	<ul style="list-style-type: none"> <li>• Appropriate current sensor may not be connected to the proper measurement channels. Check the wiring configuration and the connected sensor.</li> </ul>
Out of SD card space. Recording will be stopped.	<ul style="list-style-type: none"> <li>• First, stop the recording. Confirm "Recording stopped." message appears, and then disappears. Backup the data file to a PC or any other external memory, and then delete files or format. When using a new SD card, it should be formatted on the DM-5, not on the PC. See <b>"To delete, transfer or format the recorded data"</b>.</li> </ul>
Out of internal memory space. Recording will be stopped.	<ul style="list-style-type: none"> <li>• First, stop the recording. Confirm "Recording stopped." message appears, and then disappears. Backup the data file to a PC or SD card, and then delete files or format. See <b>"To delete, transfer or format the recorded data"</b>.</li> </ul>



**Visit [www.Amprobe.com](http://www.Amprobe.com) for**

- **Catalog**
- **Application notes**
- **Product specifications**
- **User manuals**

**Amprobe®**

[www.Amprobe.com](http://www.Amprobe.com)

[info@amprobe.com](mailto:info@amprobe.com)

Everett, WA 98203

Tel: 877-AMPROBE (267-7623)

**Amprobe® Europe**

Beha-Amprobe

In den Engematten 14

79286 Glottertal, Germany

Tel.: +49 (0) 7684 8009 - 0



Please  
Recycle