

DESCRIPTION: FEMALE - HIGH DENSITY - MACHINED CONTACTS - SOLDER CUP

**MATERIAL:**

SHELL: STEEL MATERIAL, NICKEL FINISH  
 INSULATOR: PBT THERMOPLASTIC 30% GLASS FILLED, UL 94V-0 RATED, BLACK  
 CONTACT MATERIAL: BRASS  
 CONTACT FINISH: SELECTIVE GOLD FINISHED  
 SEALING MATERIAL: F04 FLEXIBLE ADHESIVE

**ELECTRICAL:**

CONTACT CURRENT RATING: 5 AMPS  
 CONTACT RESISTANCE: 30 Milliohms Max.  
 DIELECTRIC WITHSTANDING VOLTAGE: 1,000VAC Min.  
 INSULATION RESISTANCE: 5,000 Megohms Min.  
 TEMPERATURE RATING: -55° ~ +105° C

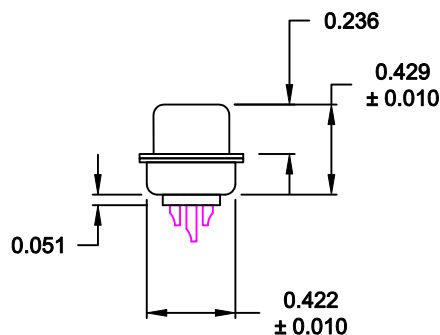
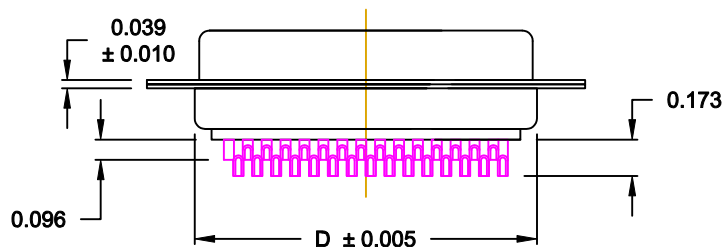
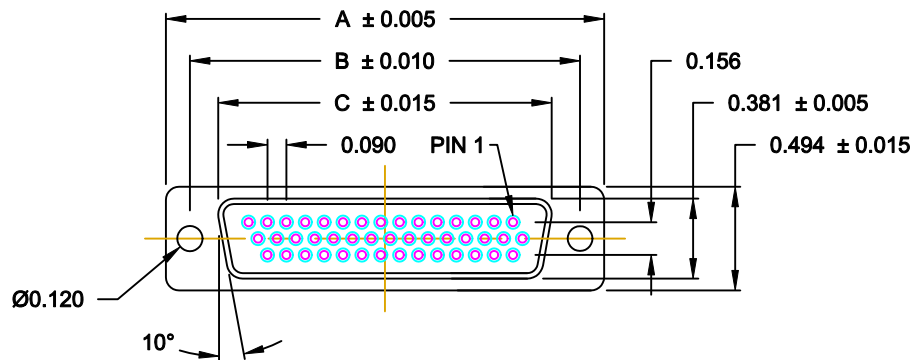

ACCEPTS 28 - 24 AWG WIRE

DIMENSIONS (IN.)				
No. OF PINS	A	B	C	D
15	1.213	0.984	0.643	0.759
25	1.541	1.312	0.971	1.083
44	2.088	1.852	1.511	1.625

MEETS IP67 STANDARDS

(SEE PAGE 2 FOR SEALING DETAILS)

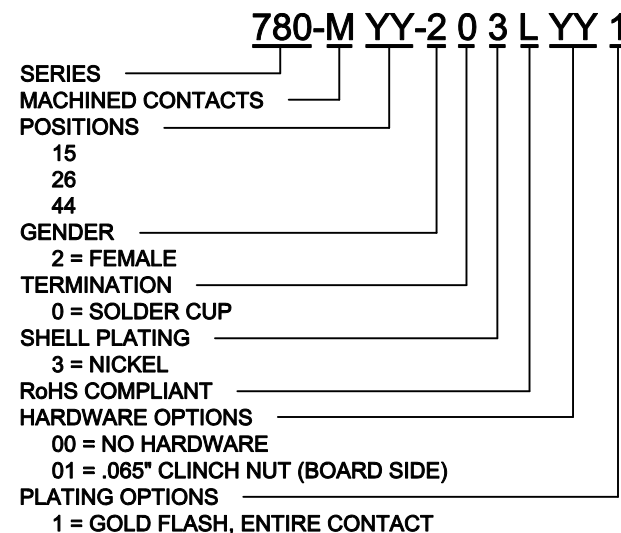

DO NOT SCALE FROM DRAWING

RoHS COMPLIANT

	THESE DRAWINGS AND SPECIFICATIONS ARE THE PROPERTY OF NorComp AND SHALL NOT BE REPRODUCED, COPIED OR USED AS THE BASIS FOR THE MANUFACTURE OF SALE OF APPARATUS WITHOUT WRITTEN PERMISSION.		DRAWN: <b>C. SMITH</b>	DATE: <b>03-13-07</b>
			CHECKED:	DATE:
<h1>NorComp</h1>		SCALE: <b>1:1</b>	SHEET <b>1</b> OF <b>2</b>	REV <b>2</b>
		DWG NO. <b>780-MYY-203LYY1</b>		

HARDWARE OPTION

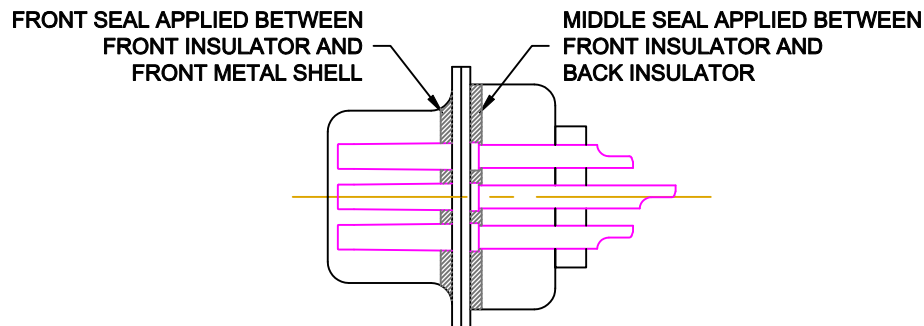
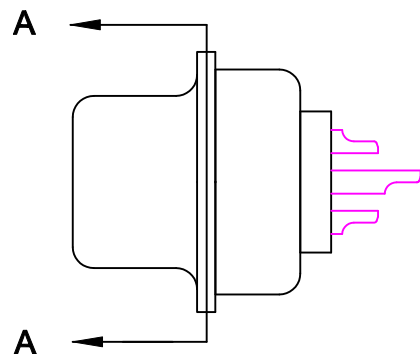

DETAIL A-A

01X ..... 0.065" (BOARD SIDE) - CN1

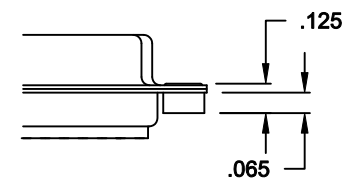

DO NOT SCALE FROM DRAWING



THESE DRAWINGS AND SPECIFICATIONS ARE THE PROPERTY OF NorComp AND SHALL NOT BE REPRODUCED, COPIED OR USED AS THE BASIS FOR THE MANUFACTURE OR SALE OF APPARATUS WITHOUT WRITTEN PERMISSION.

DRAWN:  
**C. SMITH**

DATE:  
**03-26-09**

CHECKED:

DATE:

**NorComp**

SCALE: <b>2.5 : 1</b>	SHEET <b>2</b>	OF <b>2</b>	REV <b>2</b>
--------------------------	-------------------	----------------	-----------------

DWG NO. **780-MYY-203LYY1**