

# 40x40x6 mm

5.5~5.9 CFM



■ Specifications

	Bearing	Rating Voltage	Power Current	Power Consumption	Speed	Air Flow	Static Pressure	Noise	Weight	Curve
	● VAPO	(VDC)	(mA)	(WATTS)	(RPM)	(CFM)	(Inch-H <sub>2</sub> O)	(dB(A))	(g)	
MF40060V1-000U-A99	●	5	87	0.44	7000	5.9	0.10	29.9	6.8	1
MF40060V2-000U-A99	●	5	65	0.33	6000	5.5	0.08	25.7	6.8	2

■ Air Flow-Static Pressure Characteristics

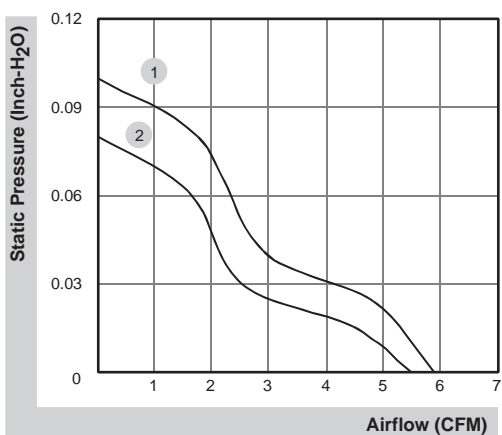

■ External dimensions(mm)

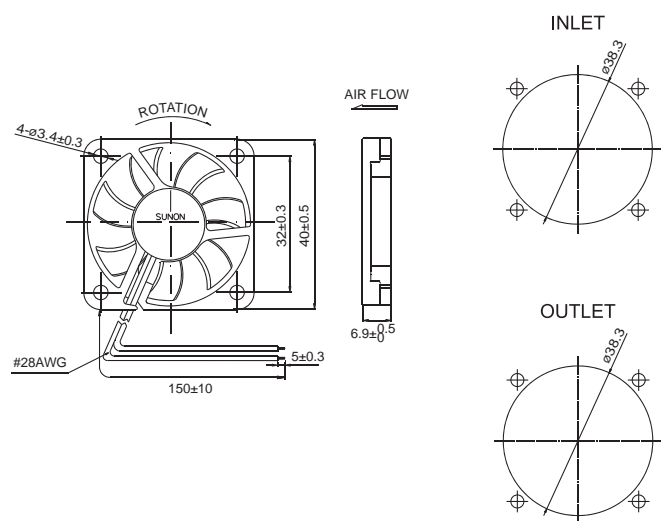

\*All model could be customized. Please contact with Sunon Sales.

\*Specifications are subject to change without notice. Please Visit SUNON website at [www.sunon.com](http://www.sunon.com) for update information.