

**AQ1026 Series 15pF 30kV Bidirectional Discrete TVS**

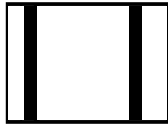

**Pinout**



**Functional Block Diagram**



**Description**

Avalanche breakdown diodes fabricated in a proprietary silicon avalanche technology protect each I/O pin to provide a high level of protection for electronic equipment that may experience destructive electrostatic discharges (ESD). These robust diodes can safely absorb repetitive ESD strikes at  $\pm 30\text{kV}$  (contact discharge, IEC 61000-4-2) without performance degradation. Additionally, each diode can safely dissipate 5A of 8/20 $\mu\text{s}$  surge current (IEC 61000-4-5 2<sup>nd</sup> edition) with very low clamping voltages.

**Features**

- ESD, IEC 61000-4-2,  $\pm 30\text{kV}$  contact,  $\pm 30\text{kV}$  air
- EFT, IEC 61000-4-4, 40A (5/50ns)
- Lightning, IEC 61000-4-5 2<sup>nd</sup> edition, 5A (8/20 $\mu\text{s}$ )
- Low leakage current of 0.5 $\mu\text{A}$  (MAX) at 5V
- Space efficient 0201 footprint
- AEC-Q101 qualified
- Halogen free, lead free and RoHS compliant
- Moisture Sensitivity Level (MSL -1)

**Applications**

- Mobile phones
- Smart phones
- Smart watches
- Tablets
- Portable navigation components
- Portable medical components
- Automotive Applications

**Application Example**

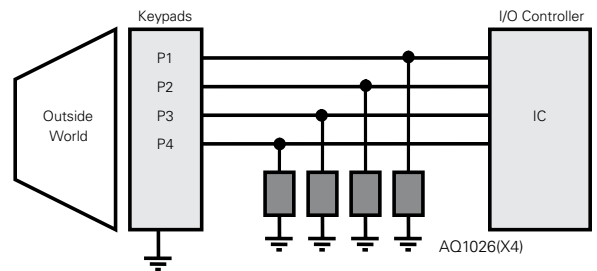

Life Support Note:

**Not Intended for Use in Life Support or Life Saving Applications**

The products shown herein are not designed for use in life sustaining or life saving applications unless otherwise expressly indicated.

### Absolute Maximum Ratings

Symbol	Parameter	Value	Units
$I_{PP}$	Peak Pulse Current ( $t_p=8/20\mu s$ )	5	A
$T_{OP}$	Operating Temperature	-40 to 150	°C
$T_{STOR}$	Storage Temperature	-55 to 150	°C

CAUTION: Stresses above those listed in "Absolute Maximum Ratings" may cause permanent damage to the component. This is a stress only rating and operation of the component at these or any other conditions above those indicated in the operational sections of this specification is not implied.

### Thermal Information

Parameter	Rating	Units
Maximum Junction Temperature	150	°C
Maximum Lead Temperature (Soldering 30s)	260	°C

### Electrical Characteristics ( $T_{OP}=25^\circ C$ )

Parameter	Symbol	Test Conditions	Min	Typ	Max	Units
Reverse Standoff Voltage	$V_{RWM}$				6.0	V
Breakdown Voltage	$V_{BR}$	$I_R=1mA$ (Pin 1 to 2)		7.8		V
Leakage Current	$I_{LEAK}$	$V_R=5V$		0.1	0.5	$\mu A$
Clamp Voltage <sup>1</sup>	$V_C$	$I_{PP}=1A, t_p=8/20\mu s$ (Pin 1 to 2)		12.0		V
		$I_{PP}=2A, t_p=8/20\mu s$ (Pin 1 to 2)		13.4		V
Dynamic Resistance	$R_{DYN}$	$(V_{C2} - V_{C1}) / (I_{PP2} - I_{PP1})$		1.4		$\Omega$
ESD Withstand Voltage <sup>1</sup>	$V_{ESD}$	IEC 61000-4-2 (Contact Discharge)	$\pm 30$			kV
		IEC 61000-4-2 (Air Discharge)	$\pm 30$			kV
Diode Capacitance <sup>1</sup>	$C_D$	Reverse Bias=0V		15		pF
		Reverse Bias=2.5V		12		pF

Note: <sup>1</sup> Parameter is guaranteed by design and/or component characterization.

### Capacitance vs. Reverse Bias

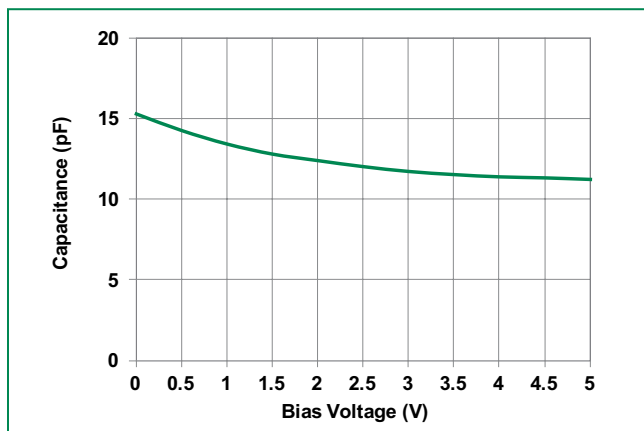

### Insertion Loss (S21) I/O to GND

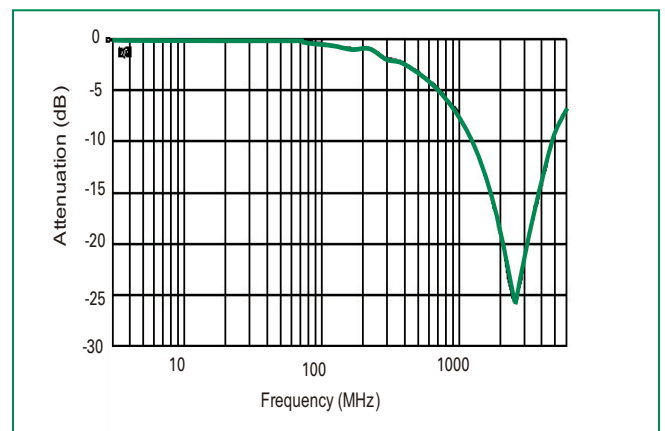

**Clamping Voltage vs.  $I_{PP}$**

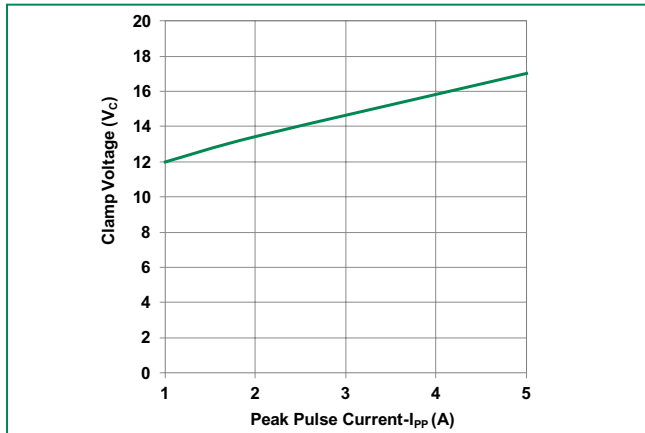

**Transmission Line Pulsing(TLP) Plot**

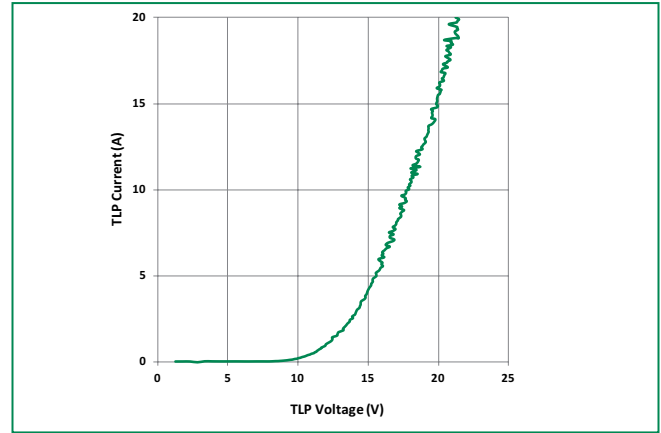

**Soldering Parameters**

Reflow Condition	Pb – Free assembly	
Pre Heat	- Temperature Min ( $T_{s(min)}$ )	150°C
	- Temperature Max ( $T_{s(max)}$ )	200°C
	- Time (min to max) ( $t_s$ )	60 – 180 secs
Average ramp up rate (Liquidus) Temp ( $T_L$ ) to peak		3°C/second max
$T_{s(max)}$ to $T_L$ - Ramp-up Rate		3°C/second max
Reflow	- Temperature ( $T_L$ ) (Liquidus)	217°C
	- Temperature ( $t_L$ )	60 – 150 seconds
Peak Temperature ( $T_p$ )		260 <sup>+0/-5</sup> °C
Time within 5°C of actual peak Temperature ( $t_p$ )		20 – 40 seconds
Ramp-down Rate		6°C/second max
Time 25°C to peak Temperature ( $T_p$ )		8 minutes Max.

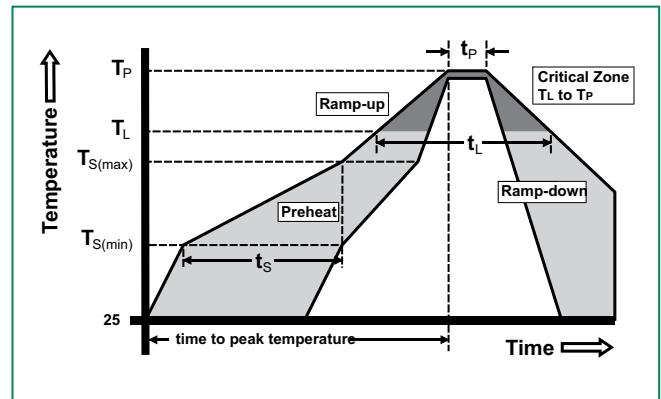

**Product Characteristics**

<b>Lead Plating</b>	Pre-Plated Frame
<b>Lead Material</b>	Copper Alloy
<b>Substrate material</b>	Silicon
<b>Body Material</b>	Molded Epoxy
<b>Flammability</b>	UL Recognized epoxy meeting flammability rating V-0.

- Notes :
1. All dimensions are in millimeters
  2. Dimensions include solder plating.
  3. Dimensions are exclusive of mold flash & metal burr.
  4. Blo is facing up for mold and facing down for trim/form, i.e. reverse trim/form.
  5. Package surface matte finish VDI 11-13.

**Package Dimensions —  $\mu$ DFN-2 (0201)**

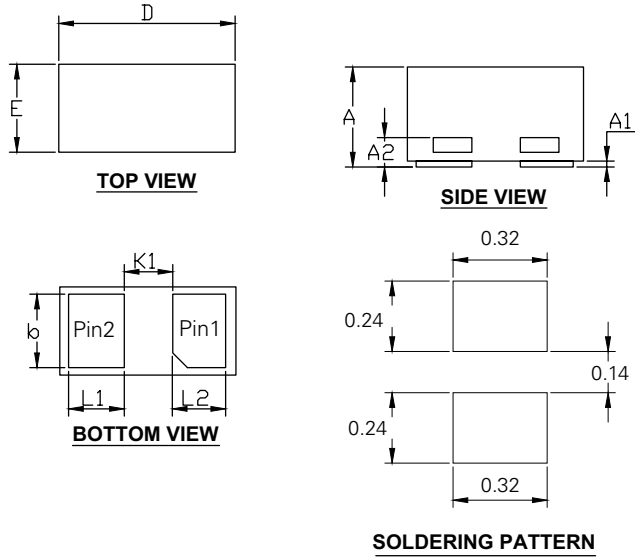

Package	$\mu$ DFN-2 (0201)			
JEDEC	MO-236			
Symbol	Millimeters		Inches	
	Min	Max	Min	Max
<b>A</b>	0.23	0.33	0.009	0.013
<b>A1</b>	0.00	0.05	0.000	0.002
<b>A2</b>	0.10 REF		0.004 REF	
<b>b</b>	0.18	0.30	0.007	0.012
<b>D</b>	0.55	0.65	0.022	0.026
<b>E</b>	0.25	0.35	0.010	0.014
<b>L1</b>	0.12	0.24	0.005	0.009
<b>L2</b>	0.12	0.23	0.005	0.009
<b>K1</b>	0.165 REF		0.006 REF	

**Part Numbering System**

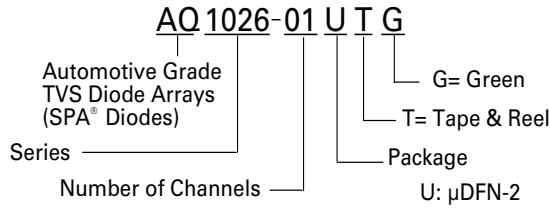

**Ordering Information**

Part Number	Package	Marking	Min. Order Qty.
AQ1026-01UTG	$\mu$ DFN-2		15000

**Part Marking System**



**Embossed Carrier Tape & Reel Specification –  $\mu$ DFN-2**

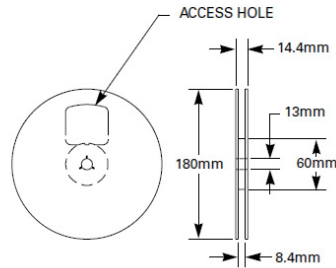
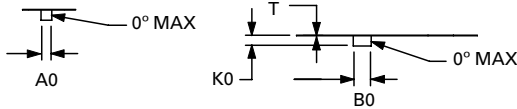
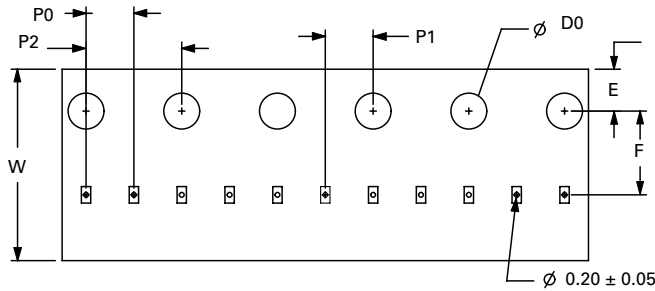

8mm TAPE AND REEL

Symbol	Millimetres		Inches	
	Min	Max	Min	Max
<b>A0</b>	0.33	0.40	0.013	0.016
<b>B0</b>	0.63	0.70	0.025	0.028
<b>D0</b>	1.40	1.60	0.055	0.063
<b>E</b>	1.65	1.85	0.065	0.073
<b>F</b>	3.45	3.55	0.136	0.140
<b>K0</b>	0.30	0.39	0.012	0.015
<b>P0</b>	1.90	2.10	0.075	0.083
<b>P1</b>	1.95	2.05	0.077	0.081
<b>P2</b>	3.90	4.10	0.154	0.161
<b>T</b>	0.13	0.25	0.005	0.010
<b>W</b>	7.90	8.30	0.311	0.327

**Disclaimer Notice - Information furnished is believed to be accurate and reliable. However, users should independently evaluate the suitability of and test each product selected for their own applications. Littelfuse products are not designed for, and may not be used in, all applications. Read complete Disclaimer Notice at <http://www.littelfuse.com/disclaimer-electronics>.**