

10 9 8 7 6 5 4 3 2 1

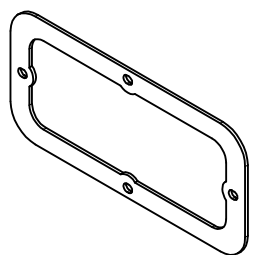

850710016

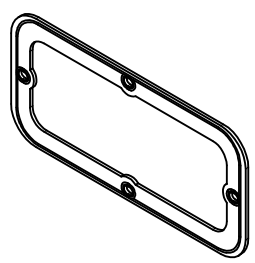
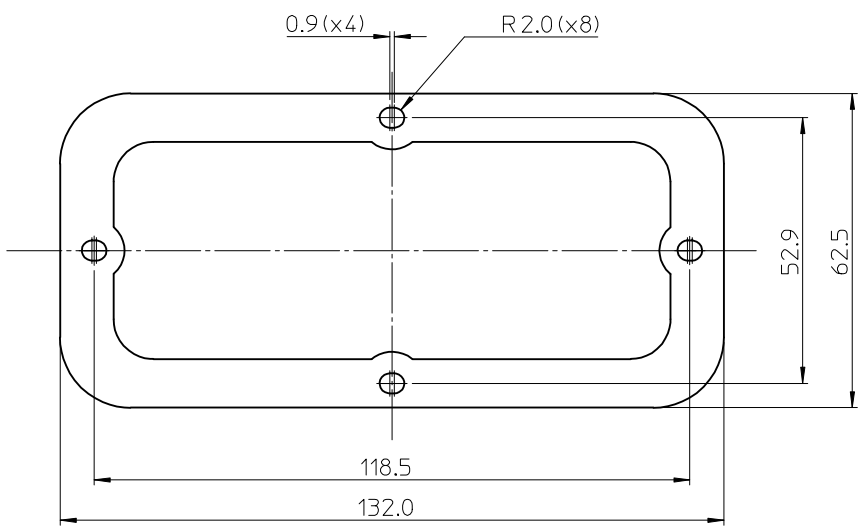
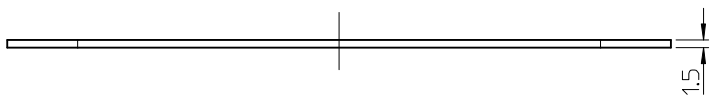

850710017

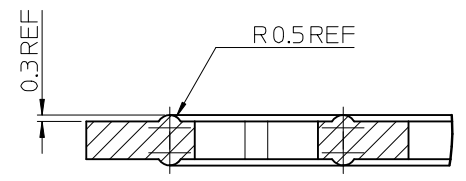

DETAIL 1

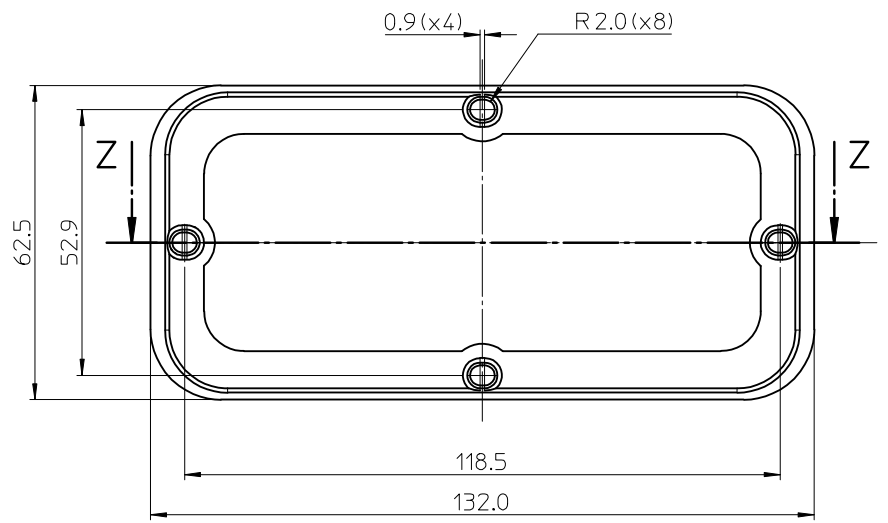
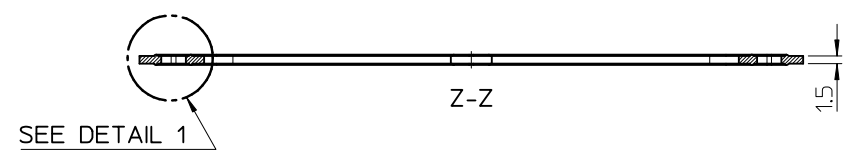

PART NUMBER	MATERIAL	COLOUR
850710016	FLUOROELASTOMER	BLACK
850710017	SILICONE RUBBER	RED

NOTES:
 1. MATERIAL: SEE TABLE
 2. PACKAGING SPECIFICATION: PK-85071-002

ORIGINAL RELEASE
 EC NO: IPG2012-0350
 DRW: DSHEA 2012/02/03
 CHKD:
 APPR: EFOLAN 2012/05/22

QUALITY SYMBOLS
 = 0
 = 0

GENERAL TOLERANCES (UNLESS SPECIFIED)

	mm	INCH
4 PLACES	± ---	± ---
3 PLACES	± ---	± ---
2 PLACES	± 0.20	± ---
1 PLACE	± 0.5	± ---
ANGULAR ± .5 °		

DRAFT WHERE APPLICABLE MUST REMAIN WITHIN DIMENSIONS

DIMENSION STYLE
MM ONLY

DRAWN BY: DSHEA
 DATE: 2012/02/03

CHECKED BY:

APPROVED BY: EFOLAN
 DATE: 2012/05/22

MATERIAL NO.
SEE TABLE

SCALE: 1:1
 DESIGN UNITS: METRIC
 THIRD ANGLE PROJECTION

TITLE: SRC FLANGE GASKET

MOLEX INCORPORATED
 DOCUMENT NO. SD-85071-016
 SHEET NO. 1 OF 1

THIS DRAWING CONTAINS INFORMATION THAT IS PROPRIETARY TO MOLEX INCORPORATED AND SHOULD NOT BE USED WITHOUT WRITTEN PERMISSION

9 8 7 6 5 4 3 2 1