

### Introduction

The VersaClock 3S - 5P3502x USB programmer board is designed to ease the way of configuring and programming the blank parts of 5P3502x family of devices. With the on-board USB interface, IDT Timing Commander™ GUI can communicate with the VersaClock 3S devices for configuration and measurement on the board. With additional socket board, configuration can be programmed to blank parts of 5P3502x. The family of VersaClock 3S devices is available on the following part numbers: 5P35023 and 5P35021.

### Board Overview

The USB programmer board (Figure 1) is ready with all necessary components and connections. It is available to test the functionality of the configuration and device can be programmed with the additional socket board as shown in Figure 2.

**Figure 1. Programmer Board Overview**

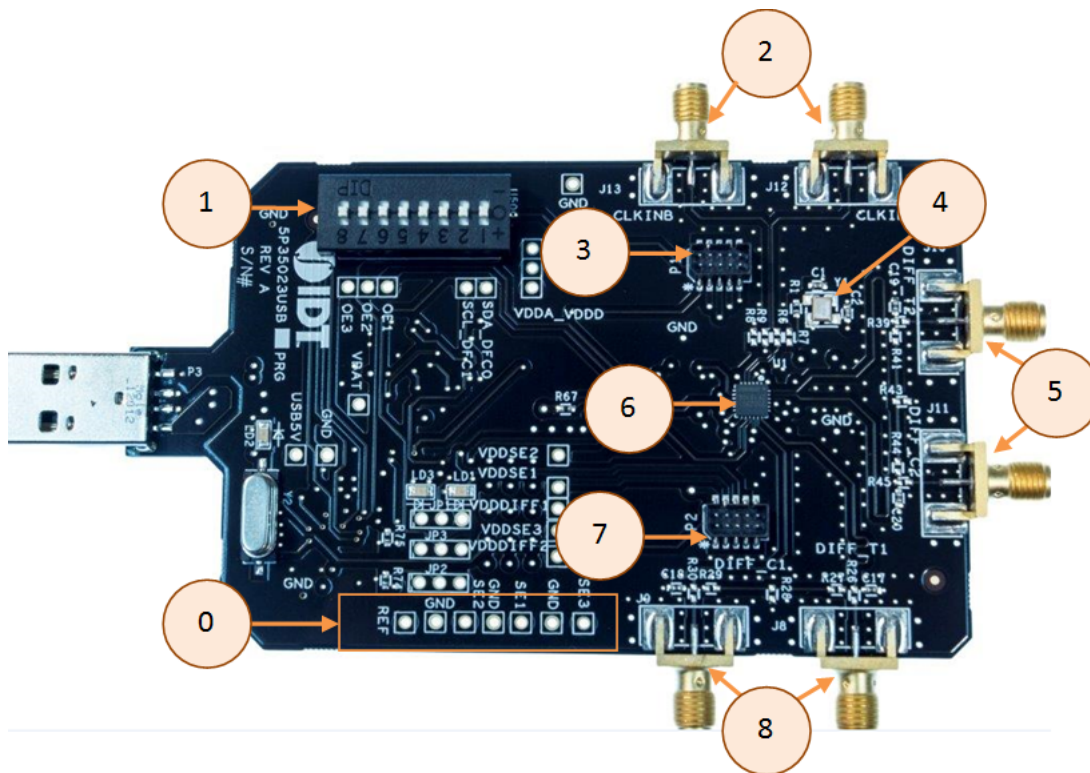



**Table 1: Programmer Board Labels and Functions**

Serial	Label	Description
0	Single-ended Outputs	These are test points for Single-ended Outputs; SE1, SE2, SE3 and Reference with GND points in between.
1	DIP Switch	This is used to configure the IC in different modes.
2	Clock Inputs	A differential clock can be connected as the source for the device or a single-ended input connected on CLKINB pin.

Serial	Label	Description
3	Socket connector	This is used to mount a 24 or 20 PIN socket board on the top of USB board for programming.
4	25MHz Crystal	Crystal with 8pF load (part number: 603-25-150) is populated.
5	Differential Outputs	This is the differential pair (Out of phase): DIFF-T2 and DIFF-C2.
6	Chip	This device (5P35023) is populated.
7	Socket	This is used to mount a 24 or 20 PIN socket board on the top of USB board for programming.
8	Differential Output	This is another set of differential pair (Out of phase): DIFF-T1 and DIFF-C1.

**Table 2: Programming Steps**

Step No.	Steps	Comments
1	Plug the board into the USB port	USB provides power to the board and establishes a communication channel between GUI and the device
2	Start Timing Commander Software	Launch the Timing Commander GUI software. Load the personality file. <a href="#">Timing Commander Software</a> <a href="#">Timing Commander Software for VersaClock 3S - 5P35023 User Guide</a>
3	New settings file	Using the Timing Commander GUI, start a new settings file, or open a pre-optimized file.
4	Connect to the board	Upon finalizing the configuration, click on the chip symbol on the top right corner of the GUI window. 
5	–	Once connected new options will be available on a green background indicating that the USB board has successfully connected with the board. 
6	All intended outputs should be available for measurement	Once the outputs have been validated and finalized, disconnect the USB board and install the socket board. Establish GUI connection to the DUT, write all, then proceed to the OTP burn. See <a href="#">“OTP Programming”</a> section.

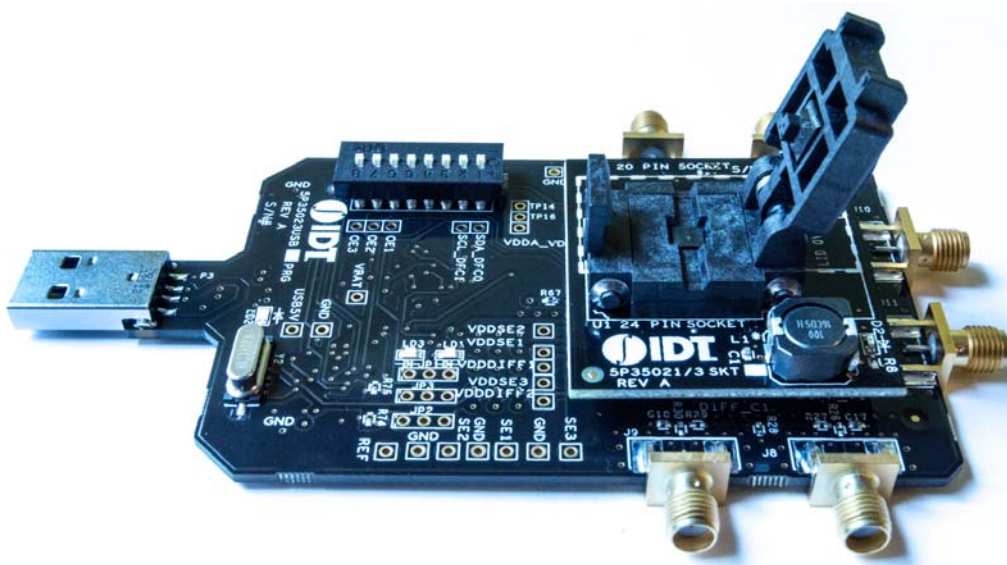
**Figure 2. USB Board (along with the Socket Board)**

Connect the USB board along with the socket board as shown above. Please, note that the blank part can only be burnt using the socket board. The part on the programming board is used for the purpose of validation. Once, the validation is complete, the user needs to connect the socket board to burn the part. The socket board supports two types of packages: 20 and 24 pins. The following description and images are restricted to 24 PIN socket board.

Upon completing the steps as described previously, proceed to install the socket board on the USB board.

When socket is open, identify the position of Pin 1 as shown in [Figure 3](#). Align the dot of the blank device with the round dent engraved on the corner of the socket as pointed. After placing the blank device, secure the socket cover.

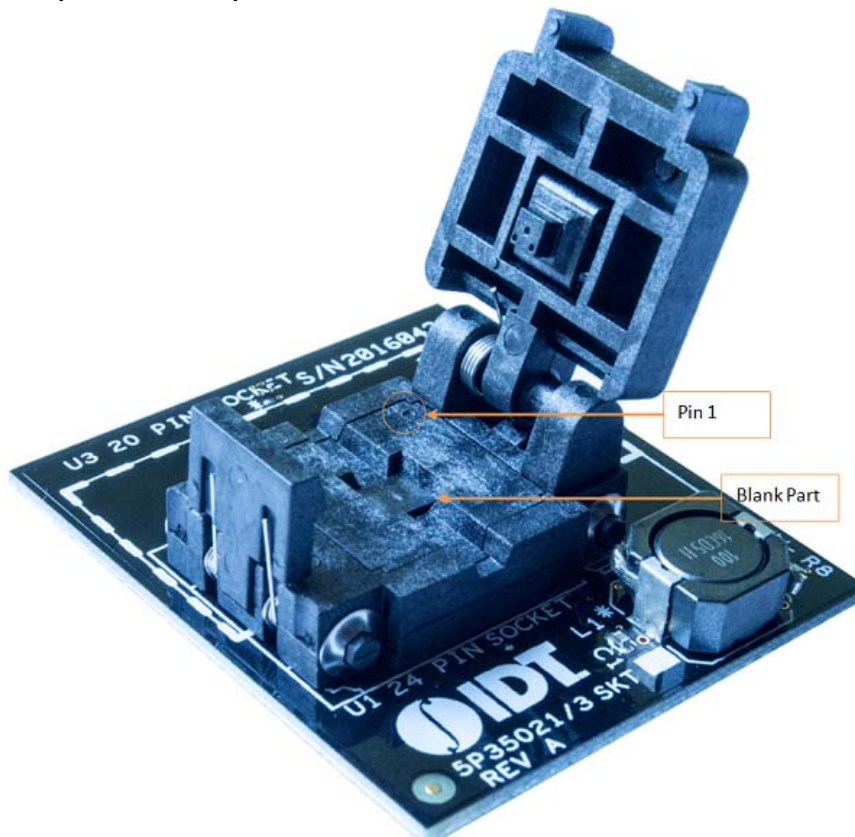
**Figure 3. Socket Board (Pin Position)**

## OTP Programming

Using the following steps the user can proceed with the OTP burn.

**Figure 4. OTP Dialogue Window**



Step 1. Upon clicking on the OTP as shown a new pop-up window will open up as shown in [Figure 5](#). Click on the “Click for OTP - Programming board” to burn the part.

**Figure 5. OTP – Programming Board**

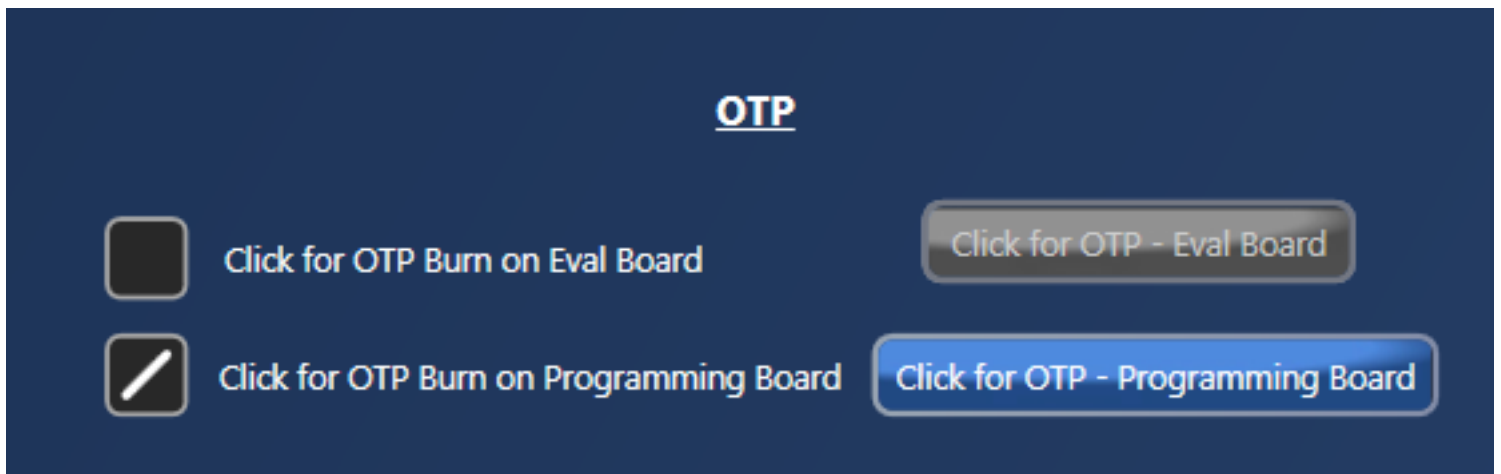

Step 2. Upon completing step 1, a dialogue box will appear as shown in [Figure 6](#). Click “Yes” to proceed.

Figure 6. OTP – 6.5V Switch

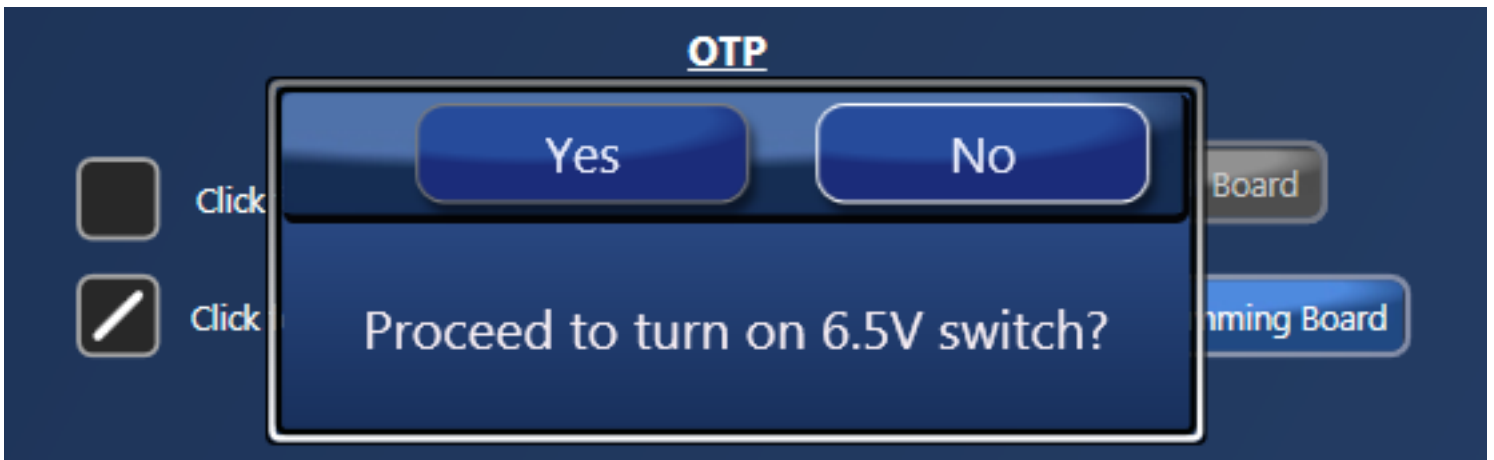
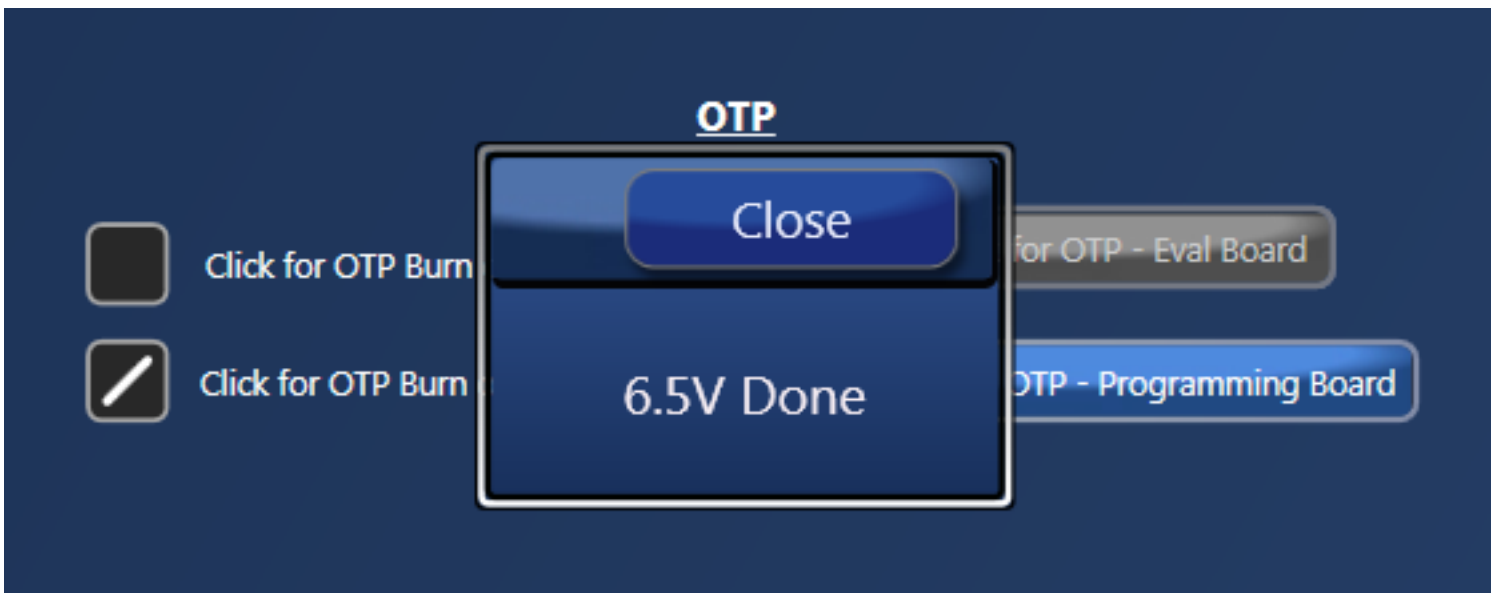
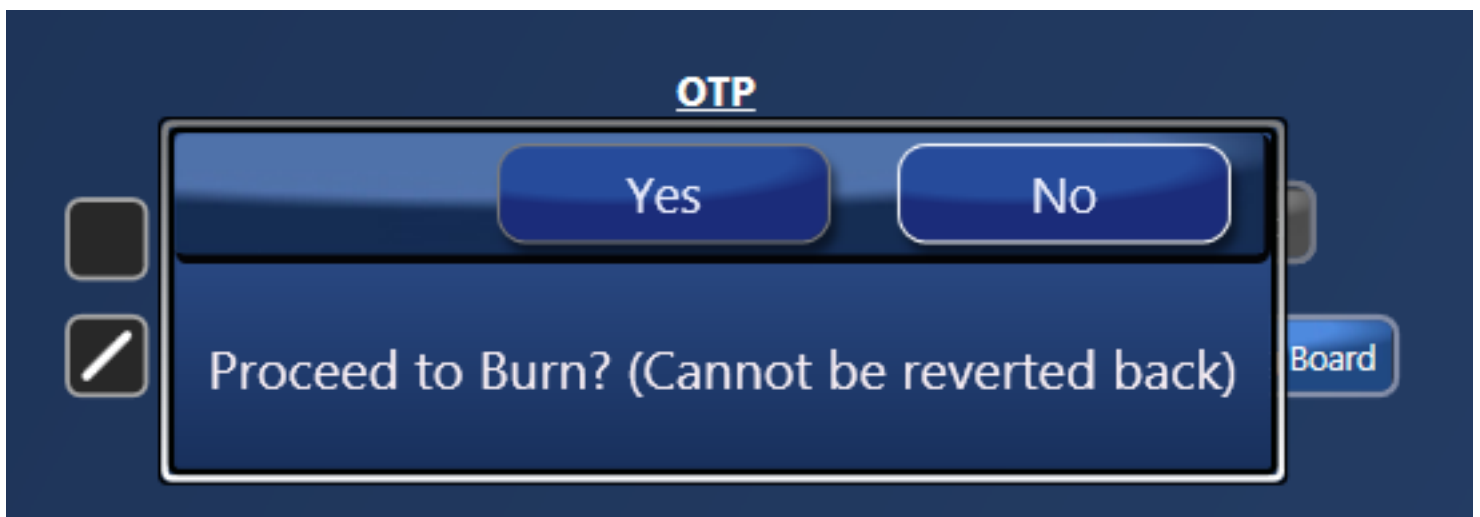

Figure 7. OTP – 6.5V Done



Step 3. Once the previous step is completed, a new window will pop-up confirming to proceed with the OTP burn. Please note that this process cannot be reverted back.

Figure 8. OTP – Proceed to Burn



Step 4. If the OTP burn process is completed, a message “OTP Programmed Successfully” will appear indicating that the process is completed, and the part has been burnt.

**Figure 9. OTP Programmed Successfully**

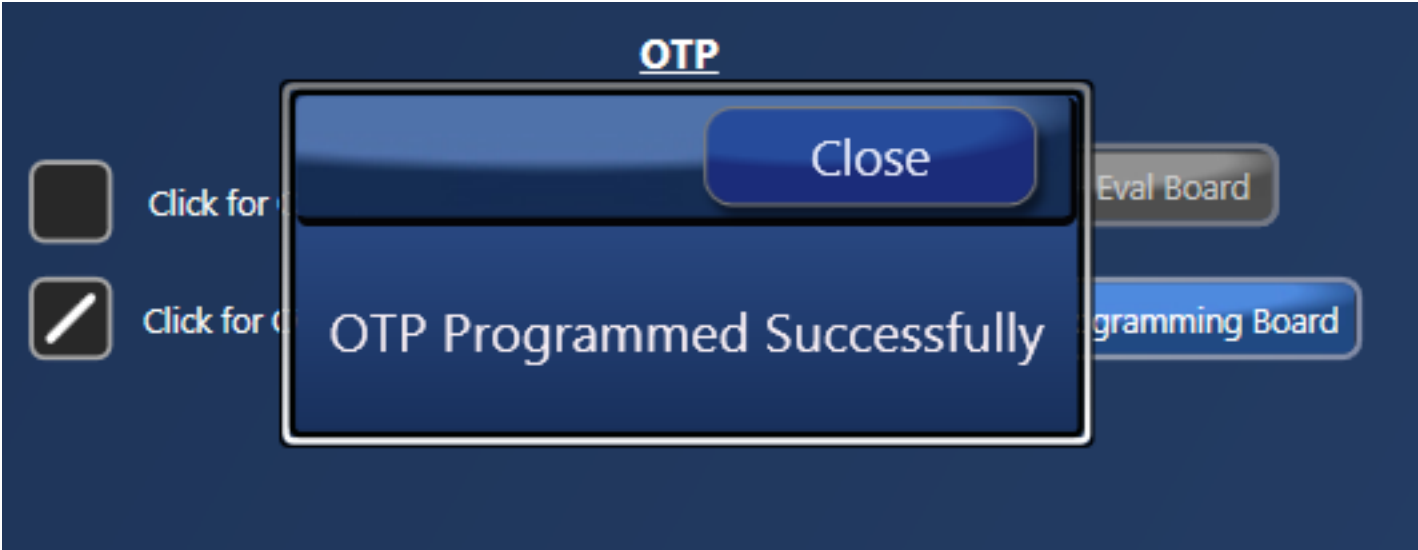
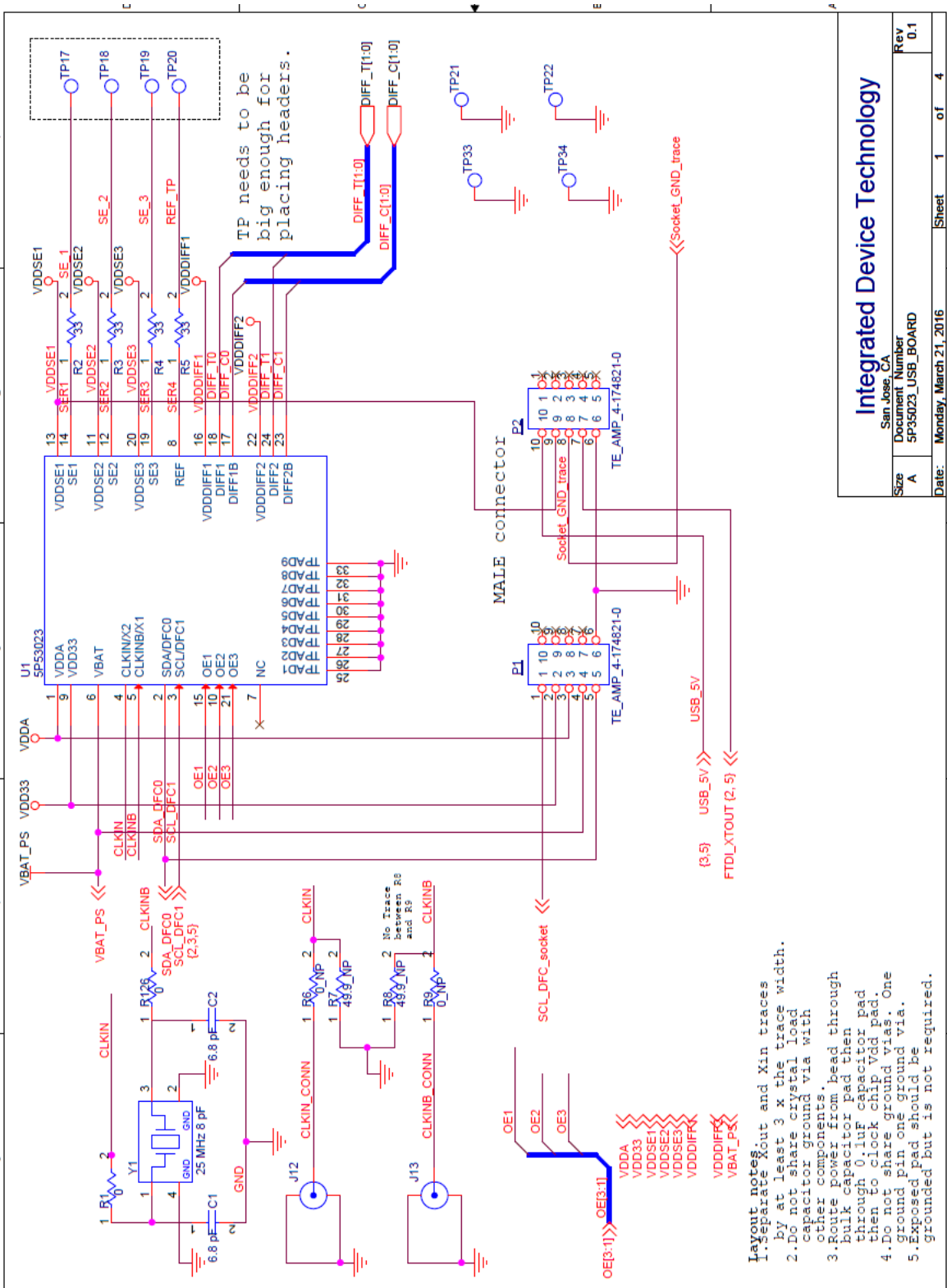
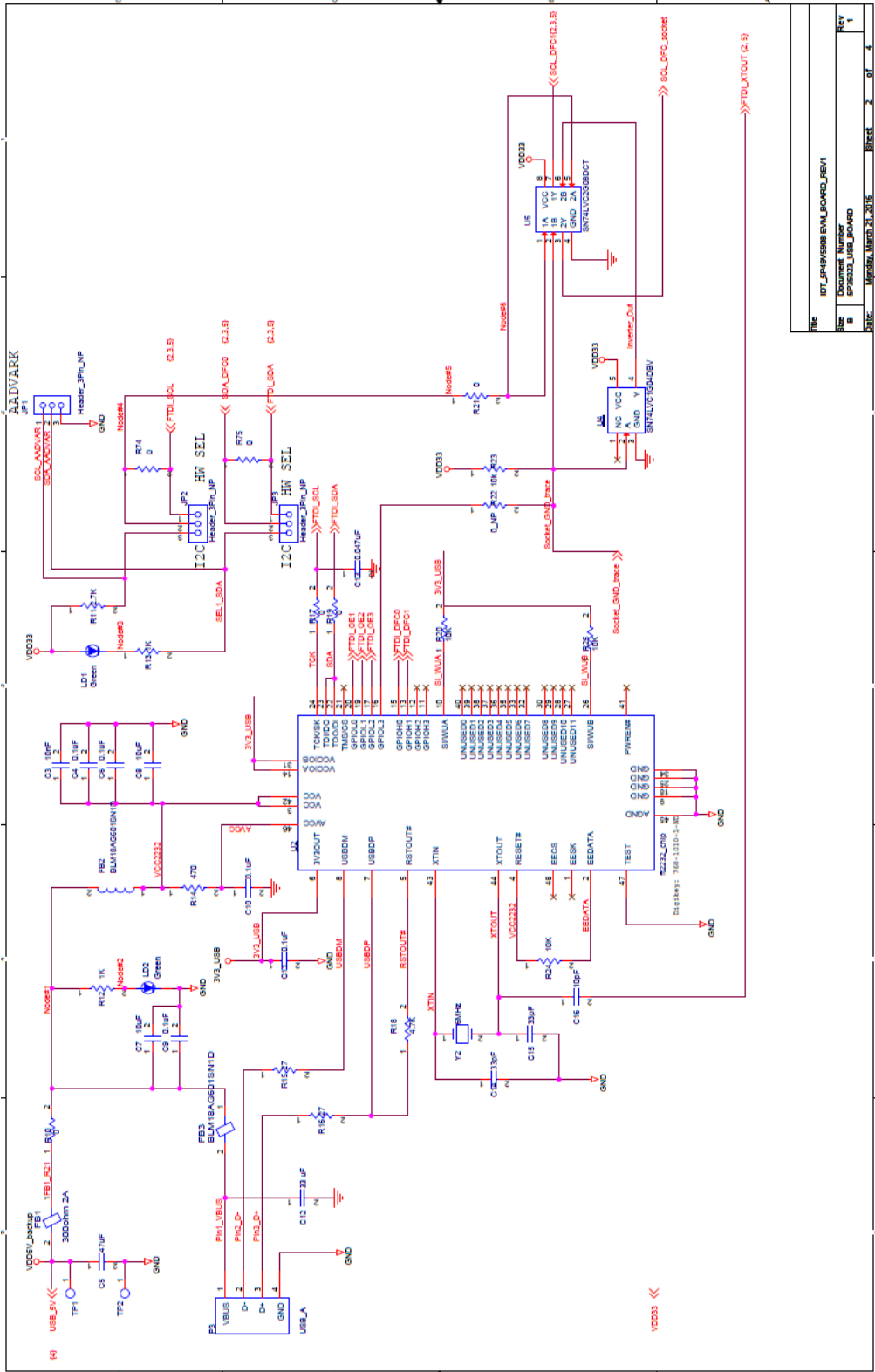

Figure 10. Schematic 1



<b>Integrated Device Technology</b>	
San Jose, CA	
Size	Document Number
A	5P35023_USB_BOARD
Date:	Monday, March 21, 2016
Sheet	1 of 4
Rev	0.1

Figure 11. Schematic 2



Doc	IDT_5P4550B ENLBOARD_REV1
Doc Number	5P3502X_USB_BOARD
Size	B
Rev	1
DATE	Monday, March 27, 2016
Sheet	2 of 4



Figure 12. Schematic 3

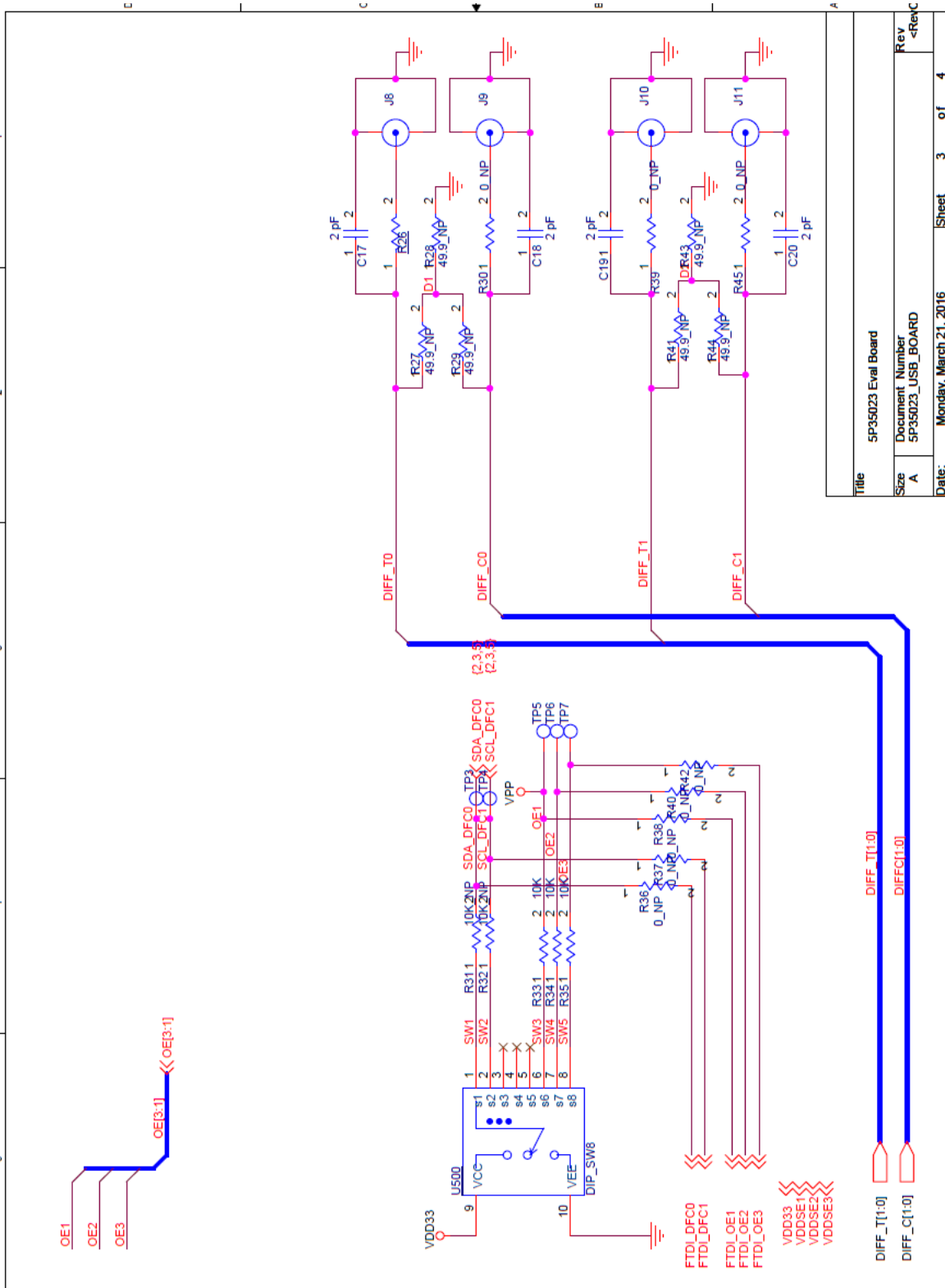
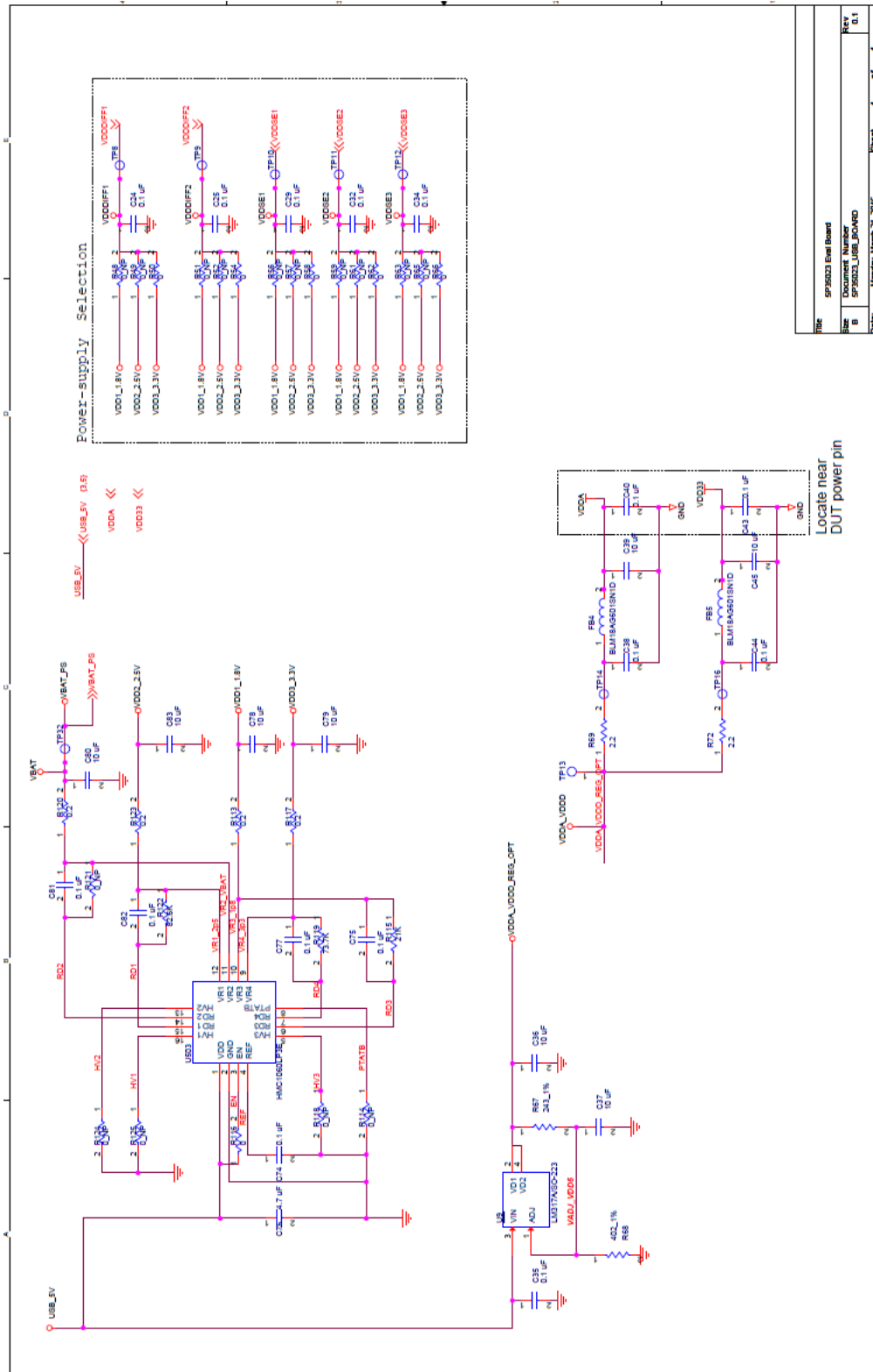

Figure 13. Schematic 4



Rev	SPR023 Eval Board
Size	Document Number
B	SPR023_USB_POWER
Date	Monday, March 21, 2018
Sheet	4 of 4
Rev	0.1

**Table 3: Termination Options for Differential Output (DIFF\_T0/C0)**

Signal Type	Series Capacitors: C17, C18	Resistor Network: R27, R28, R29	Resistor Network: R26, R30
**LPHCSL	2pF	Not installed	0 ohm

**Table 4: Termination Options for Differential Output (DIFF\_T1/C1)**

Signal Type	Series Capacitors: C19, C20	Resistor Network: R41, R43, R44	Resistor Network: R39, R45
**LPHCSL	2pF	Not installed	0 ohm

**Table 5: Termination Options for Single-ended 1**

Signal Type	Series Resistors: R2
*LVCMOS	33Ω

**Table 6: Termination Options for Single-ended 2**

Signal Type	Series Resistors: R3
*LVCMOS	33Ω

**Table 7: Termination Options for Single-ended 3**

Signal Type	Series Resistors: R4
*LVCMOS	33Ω

As noted, 4-resistor network is not installed in [Table 3](#) and [Table 4](#) because oscilloscope with internal 50Ω termination is utilized for signal termination and measurement. If an AC-coupled, stand-alone LVPECL output is needed (without oscilloscope connections), the 4-resistor network needs to be installed accordingly.

\* The Signal Type for Single-ended outputs by default is LVCMOS, and cannot be changed.

\*\* The Signal Type for Differential outputs by default is LPHCSL. Contact IDT, if the user needs to change the Signal type.

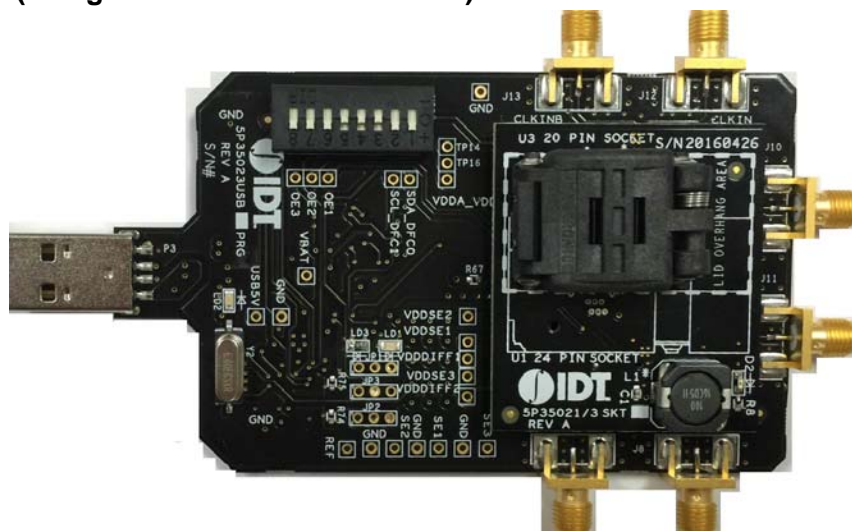
**Figure 14. USB Board (along with 20 PIN Socket Board)**



**Corporate Headquarters**  
6024 Silver Creek Valley Road  
San Jose, CA 95138 USA  
[www.IDT.com](http://www.IDT.com)

**Sales**  
1-800-345-7015 or 408-284-8200  
Fax: 408-284-2775  
[www.IDT.com/go/sales](http://www.IDT.com/go/sales)

**Tech Support**  
[www.idt.com/go/support](http://www.idt.com/go/support)

DISCLAIMER Integrated Device Technology, Inc. (IDT) and its subsidiaries reserve the right to modify the products and/or specifications described herein at any time and at IDT's sole discretion. All information in this document, including descriptions of product features and performance, is subject to change without notice. Performance specifications and the operating parameters of the described products are determined in the independent state and are not guaranteed to perform the same way when installed in customer products. The information contained herein is provided without representation or warranty of any kind, whether express or implied, including, but not limited to, the suitability of IDT's products for any particular purpose, an implied warranty of merchantability, or non-infringement of the intellectual property rights of others. This document is presented only as a guide and does not convey any license under intellectual property rights of IDT or any third parties.

IDT's products are not intended for use in applications involving extreme environmental conditions or in life support systems or similar devices where the failure or malfunction of an IDT product can be reasonably expected to significantly affect the health or safety of users. Anyone using an IDT product in such a manner does so at their own risk, absent an express, written agreement by IDT.

Integrated Device Technology, IDT and the IDT logo are registered trademarks of IDT. Product specification subject to change without notice. Other trademarks and service marks used herein, including protected names, logos and designs, are the property of IDT or their respective third party owners.

Copyright 2016. All rights reserved.