

SURFACE MOUNT 1A SCHOTTKY RECTIFIER

UPS5817
UPS5819

POWERMITE™ Package

FEATURES

- High Power Surface Mount Package
- Guard Ring Protection
- Low Forward Voltage
- Integral Heat Sink/Locking Tabs
- Compatible with Automatic Insertion Equipment
- Full Metallic Bottom Eliminates Flux Entrapment

DESCRIPTION

In Microsemi's new Powermite SMT Package, these high efficiency Schottky rectifiers offer the power handling capabilities previously found only in much larger packages. They are ideal for SMD applications that operate at high frequencies.

In addition to its size advantages, Powermite package features include a full metallic bottom that eliminates the possibility of solder flux entrapment during assembly, and a unique locking tab acts as an integral heat sink. Its innovative design makes this device ideal for use with automatic insertion equipment.

ABSOLUTE MAXIMUM RATINGS

Maximum Reverse Voltage UPS5817	20V
Maximum Reverse Voltage UPS5819	40V
Maximum Average Output Current $T_{TAB1} = 100^{\circ}\text{C}$	1.0A
Thermal Resistance, Junction to TAB_1	30°C/W
Thermal Resistance, Junction to Bottom	10°C/W
Non-Repetitive Sinusoidal Surge Current (8.3ms)	50A
Operating and Storage Temperature	-55°C to +150°C

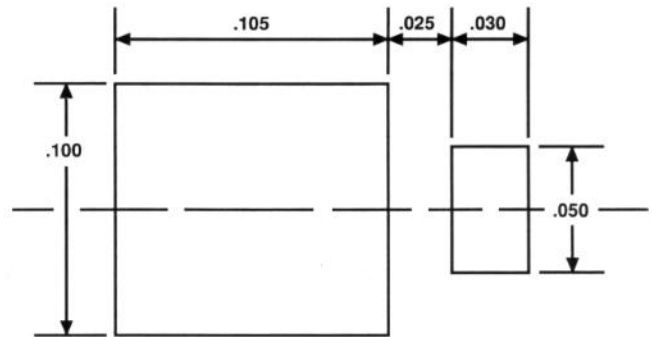
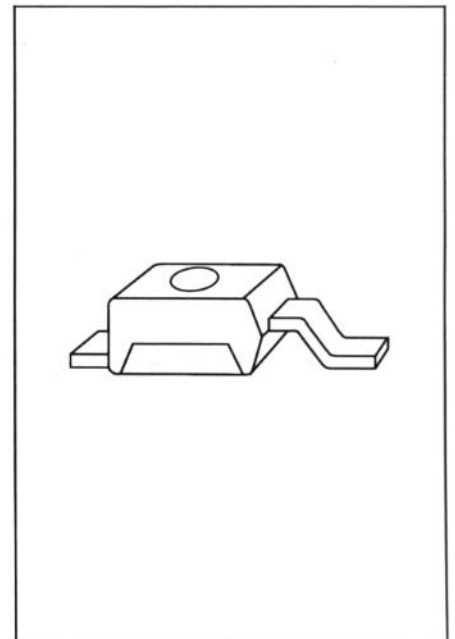
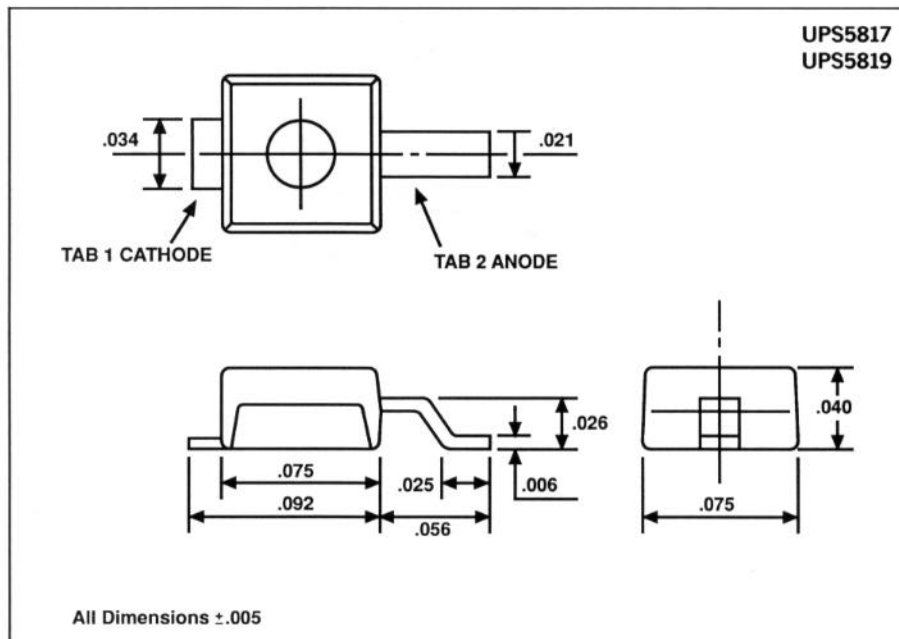

Figure 1. Suggested Mounting Pad Dimensions

MECHANICAL SPECIFICATIONS



Microsemi Corp.
Watertown

ELECTRICAL CHARACTERISTICS (T_A = 25°C unless noted)

UPS5817
UPS5819

TEST	CONDITIONS	UPS5817	UPS5819
Maximum Forward Voltage (V _{FM})	IFM = 0.1A	.36V	.39V
Maximum Forward Voltage (V _{FM})	IFM = 1.0A	.45V	.55V
Maximum Forward Voltage (V _{FM})	IFM = 3.0A	.65V	.85V
Maximum Reverse Current (I _{RM})	V _R = Max Rating	1mA	1mA
Typical Junction Capacitance	V _R = 5.0V	105pF	60pF

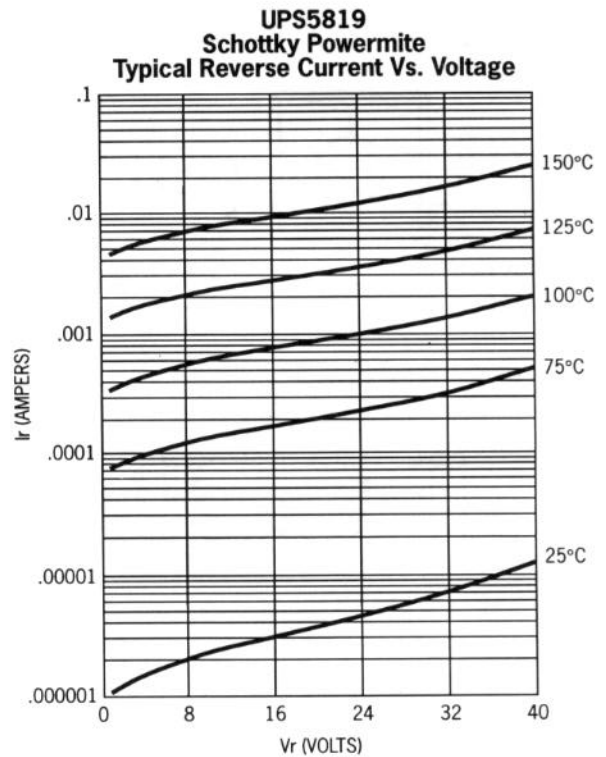
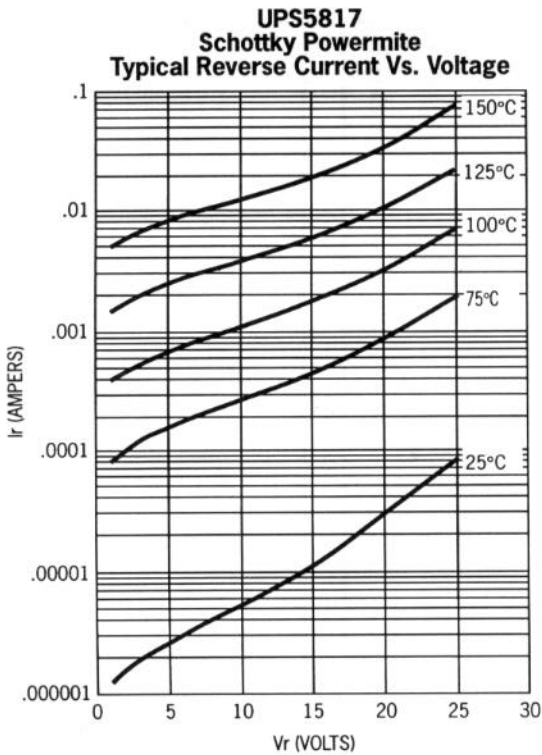
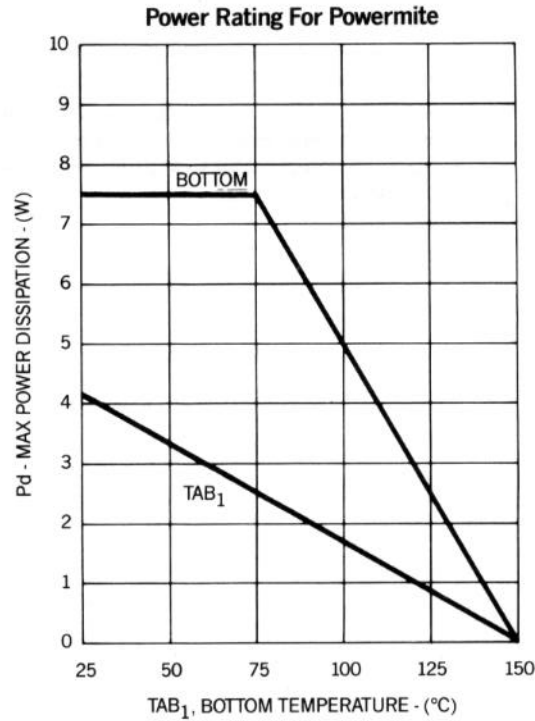

**UPS5817
Schottky Powermite
Typical Junction Capacitance**

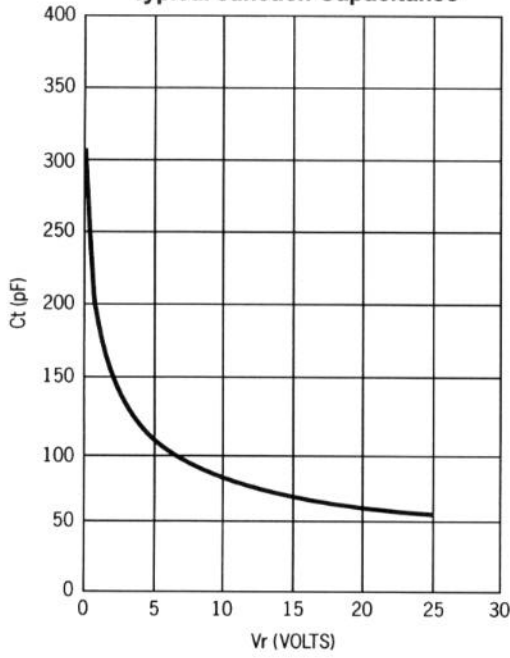

**UPS5819
Schottky Powermite
Typical Junction Capacitance**

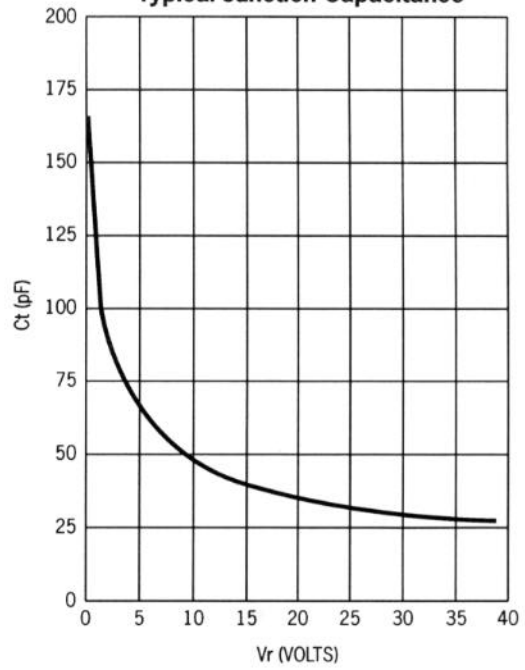

**UPS5817
Schottky Powermite
Typical Forward Voltage Vs. Forward Current**

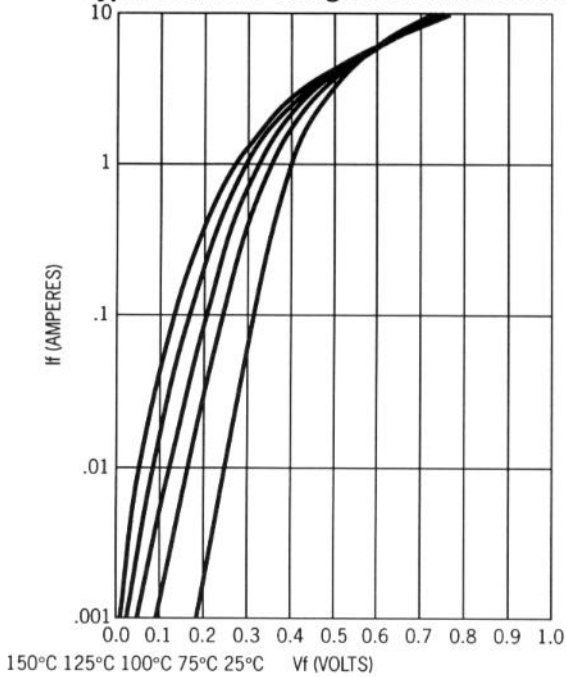

**UPS5819
Schottky Powermite
Typical Forward Voltage Vs. Forward Current**

