

# ISL9444EVAL1Z: Triple PWM Step-Down Synchronous Buck Controller

## ISL9444EVAL1Z Evaluation Board

The ISL9444EVAL1Z evaluation board (shown in Figure 1) features the ISL9444. The ISL9444 is a triple-output synchronous buck controller that integrates three PWM controllers. The ISL9444 offers external soft-start, independent enable functions and integrates UV/OV/OC/OT protection. Its current mode control architecture and internal compensation network keep peripheral component count minimal. Programmable switching frequency ranging from 200kHz to 1200kHz helps to optimize inductor size while the strong gate drivers deliver up to 25A for each PWM channel.

## Electrical Rating

The ISL9444EVAL1Z evaluation board is designed for low current application. The current rating of the ISL9444EVAL1Z is limited by the FETs and inductors selected. The ISL9444 gate drivers are capable of delivering up to 25A for each PWM channel as long as the proper FETs and inductors are provided. The electrical ratings of ISL9444EVAL1Z are shown in Table 1.

**TABLE 1. ELECTRICAL RATING**

PARAMETER	RATING
Input Voltage	6V-20V
Switching Frequency	600kHz
PWM1 Output	1.05V @ max 6A
PWM2 Output	3.3V @ max 6A
PWM3 Output	1.8V @ max 6A

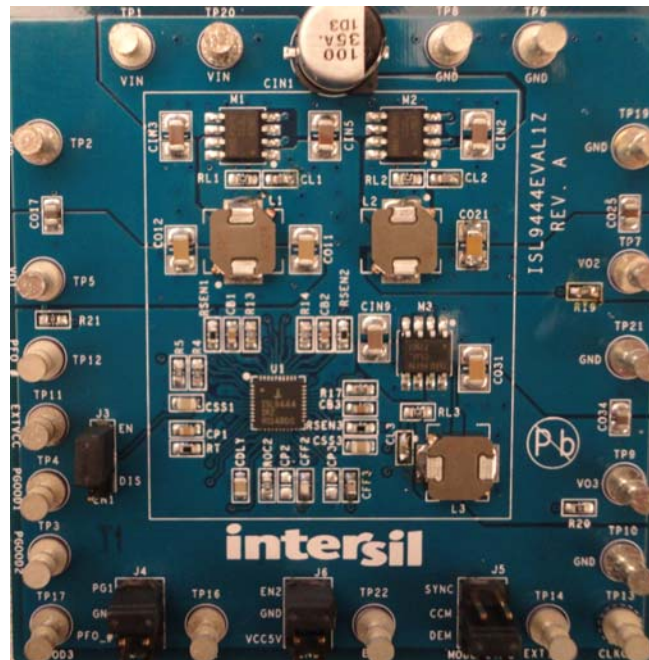

**FIGURE 1. ISL9444EVAL1Z EVALUATION BOARD**

# Application Note 1712

## What's Inside

The Evaluation Board Kit contains the following materials:

- The ISL9444EVAL1Z
- The ISL9444 datasheet
- This EVAL KIT document

## Recommended Testing Equipment

The following materials are recommended to perform testing:

- 0V to 20V Power Supply with at least 10A Source Current Capability
- Three Electronic Loads Capable of Sinking Current up to 7A
- Digital Multimeters (DMMs)
- 100MHz Quad-Trace Oscilloscope

## Quick Test Guide

1. ISL9444 has a total of three PWM outputs. Jumpers J3, J4 and J6 provide rich options to control these three PWM outputs. Please refer to Table 2 for the desired operating option. The default option is to enable PWM1 when VCC5V is ready and then enable PWM2 and PWM3 simultaneously after PWM1 finishes start-up (i.e., PGOOD1 is high).
2. Ensure that the circuit is correctly connected to the supply and electronic loads prior to applying any power. Please refer to Figure 2 for proper set-up.
3. Turn on the power supply.
4. Adjust input voltage VIN within the specified range and observe output voltage. The output voltage variation should be within 3%.
5. Adjust load current within the specified range and observe output voltage. The output voltage variation should be within 3%.
6. Use an oscilloscope to observe output voltage ripple and Phase node ringing. For accurate measurement, please refer to Figure 3 for proper test set-up.

TABLE 2.

JUMPER #	POSITION	FUNCTION
J3	EN (Pin 1-2)	Enable PWM1 when VCC5V is ready.
	DIS (Pin 2-3)	Disable PWM1
J4	PG1 (Pin 1-2)	Enable PWM2 when PGOOD1 is high. If this option is chosen, PWM2 will be enabled after PWM1 finishes start-up.
	GND (Pin 3-4)	Disable PWM2
	PFO_# (Pin 5-6)	Enable PWM2 when PFI is high. In the ISL9444EVAL1Z, PFI is connected to the input voltage through a resistor divider. If this option is chosen, PWM2 will be enabled when the input voltage is around 6.4V
J6	EN2 (Pin 1-2)	Enable PWM3 when EN2 is high. In this option, PWM3 is tracking with PWM2.
	GND (Pin 3-4)	Disable PWM3
	VCC5V (Pin 5-6)	Enable PWM3 when VCC5V is ready.

# Application Note 1712

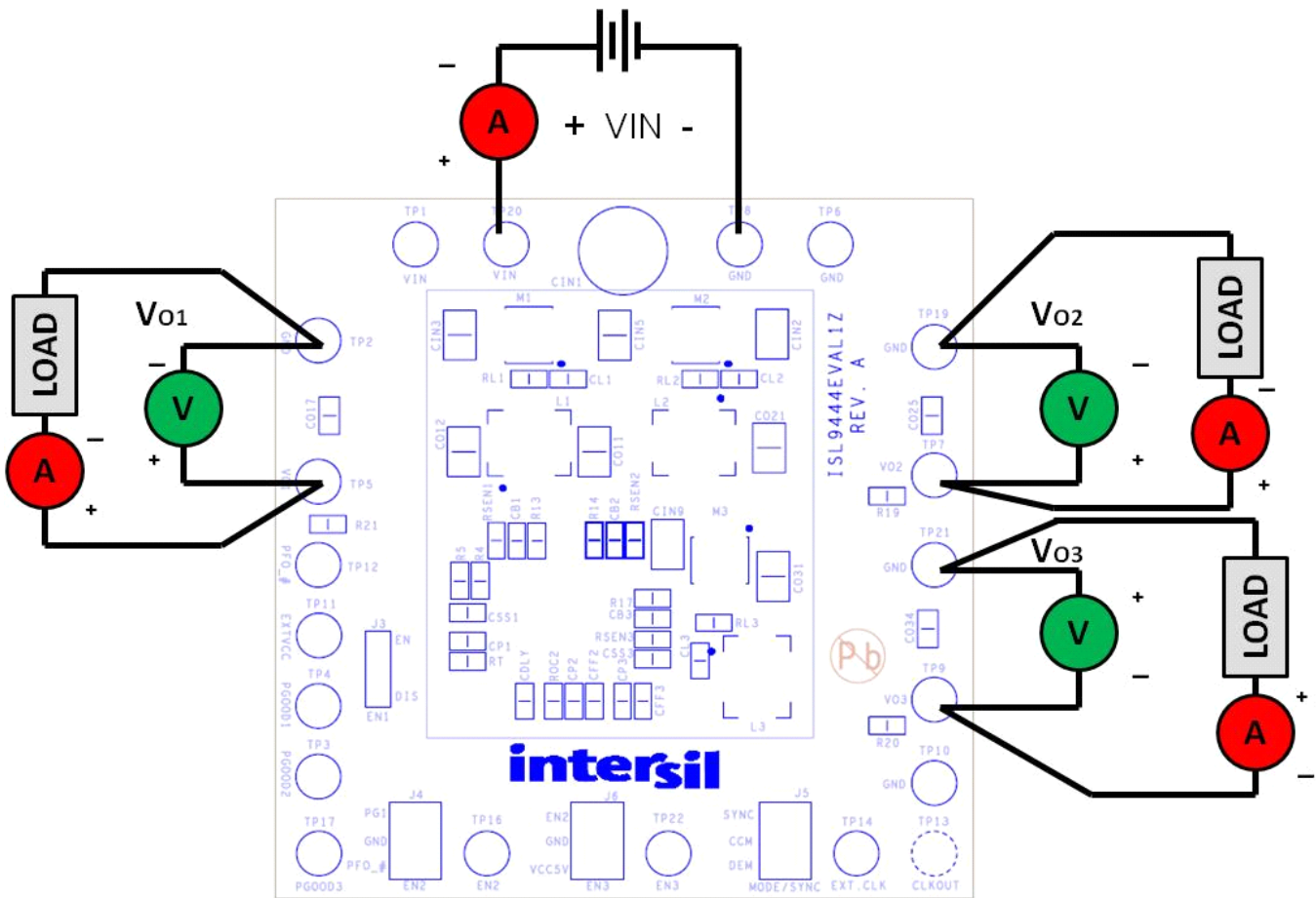

FIGURE 2. PROPER TEST SET-UP

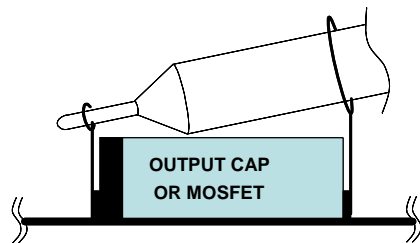

FIGURE 3. PROPER PROBE SET-UP TO MEASURE OUTPUT RIPPLE AND PHASE NODE RINGING

## Typical Evaluation Board Performance Curves $V_{IN} = 12V$ , unless otherwise noted.

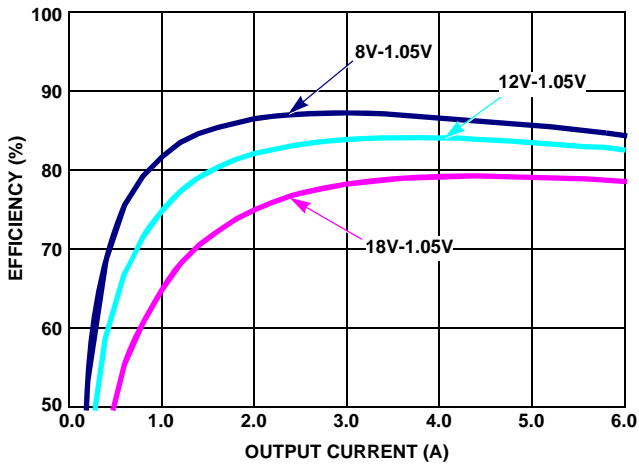

FIGURE 4. PWM1 EFFICIENCY vs LOAD ( $V_0 = 1.05V$ )

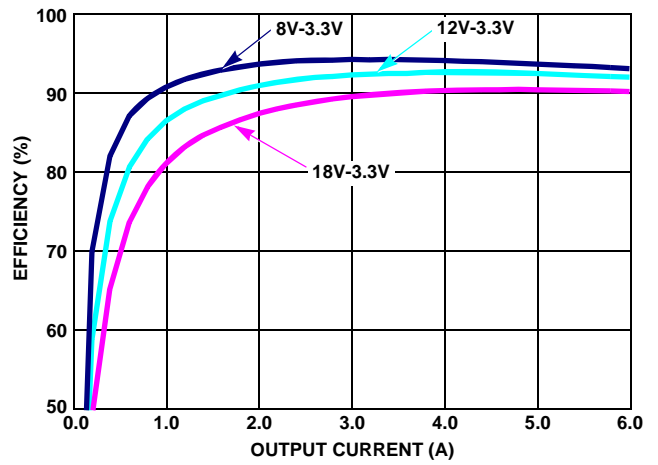

FIGURE 5. PWM2 EFFICIENCY vs LOAD ( $V_0 = 3.3V$ )

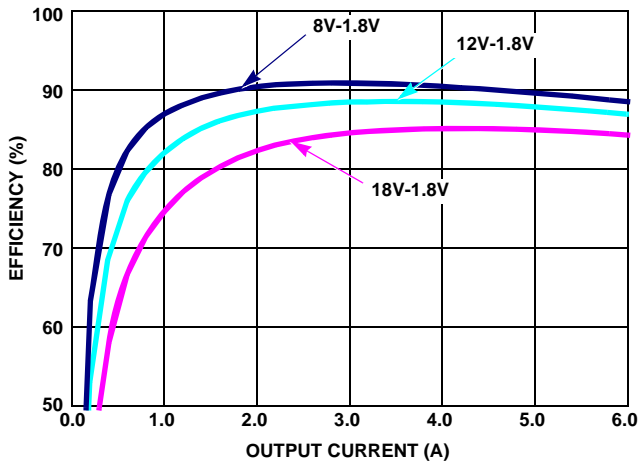

FIGURE 6. PWM3 EFFICIENCY vs LOAD ( $V_0 = 1.8V$ )

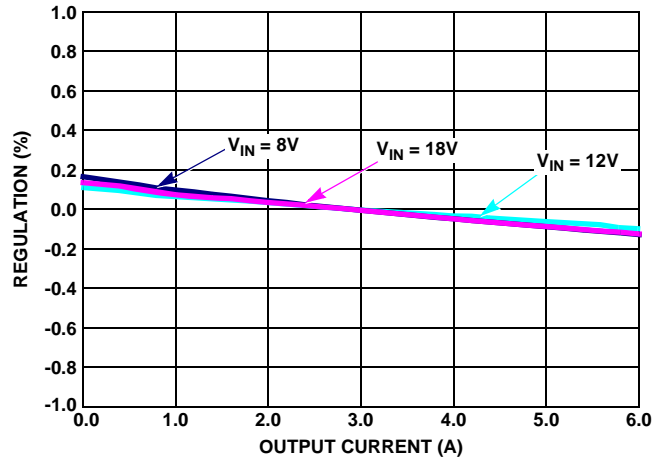

FIGURE 7. PWM1 LOAD REGULATION CURVES

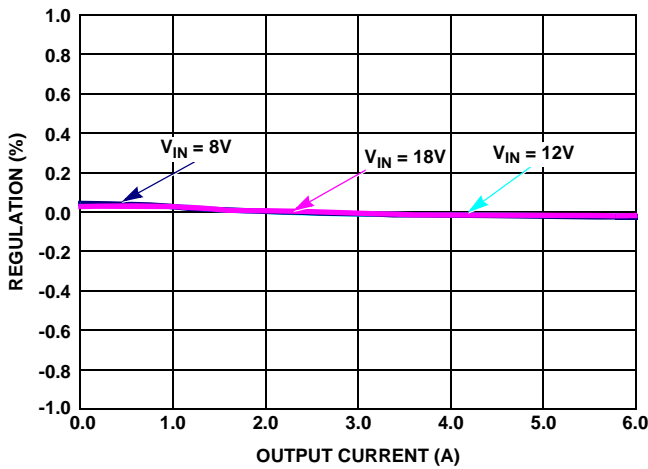

FIGURE 8. PWM2 LOAD REGULATION CURVES

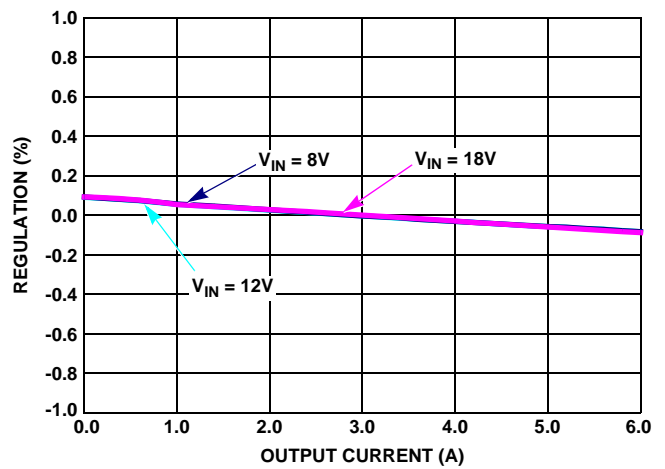

FIGURE 9. PWM3 LOAD REGULATION CURVES

## Typical Evaluation Board Performance Curves $V_{IN} = 12V$ , unless otherwise noted. (Continued)

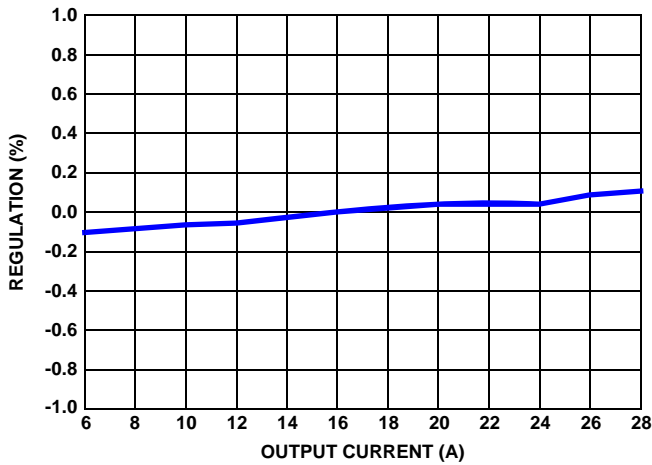

FIGURE 10. PWM1 LINE REGULATION CURVE  
( $V_{IN} = 12V$ ,  $I_{O1} = I_{O2} = I_{O3} = 6A$ )

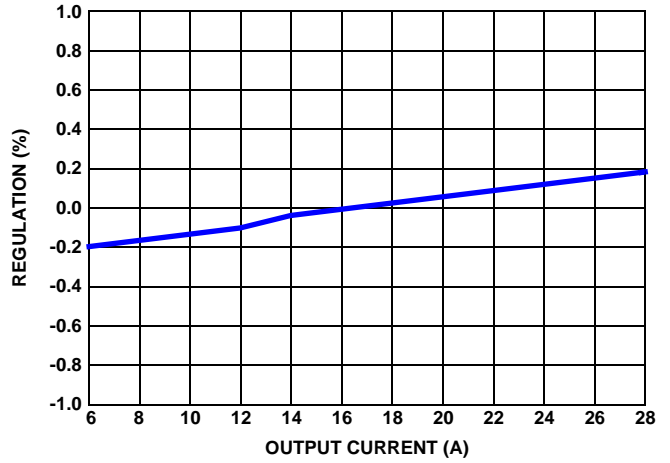

FIGURE 11. PWM2 LINE REGULATION CURVE  
( $V_{IN} = 12V$ ,  $I_{O1} = I_{O2} = I_{O3} = 6A$ )

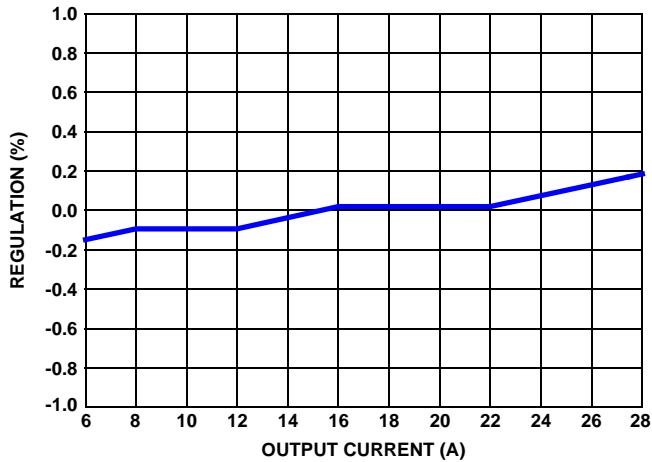

FIGURE 12. PWM3 LINE REGULATION CURVE  
( $V_{IN} = 12V$ ,  $I_{O1} = I_{O2} = I_{O3} = 6A$ )

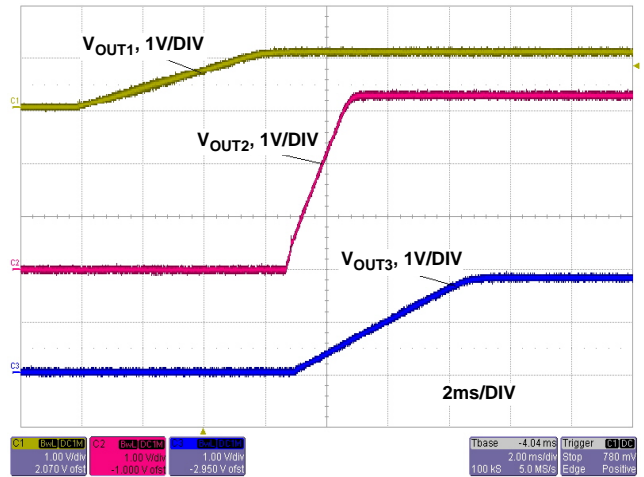

FIGURE 13. SOFT-START CURVES

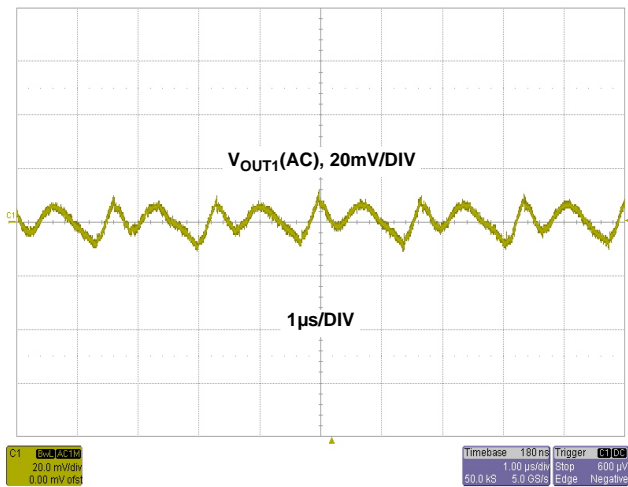

FIGURE 14. PWM1 OUTPUT RIPPLE UNDER MAX LOAD  
( $V_{IN} = 12V$ ,  $I_{O1} = I_{O2} = I_{O3} = 6A$ )

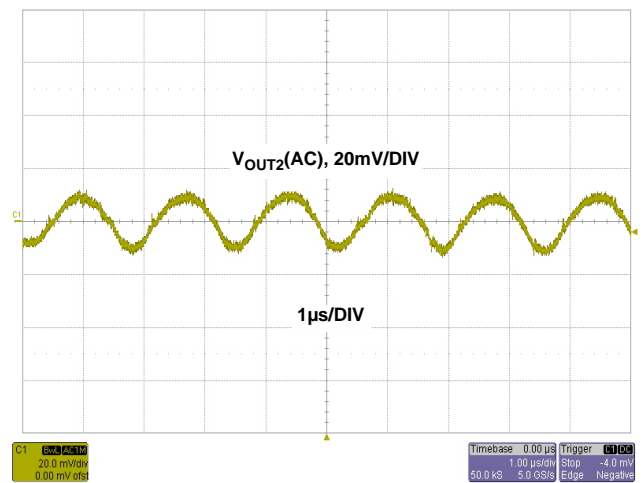

FIGURE 15. PWM2 OUTPUT RIPPLE UNDER MAX LOAD  
( $V_{IN} = 12V$ ,  $I_{O1} = I_{O2} = I_{O3} = 6A$ )

## Typical Evaluation Board Performance Curves $V_{IN} = 12V$ , unless otherwise noted. (Continued)

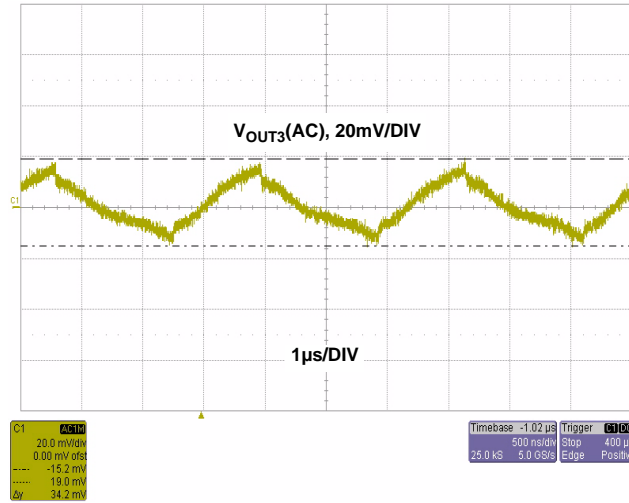

FIGURE 16. PWM3 OUTPUT RIPPLE UNDER MAX LOAD ( $V_{IN} = 12V, I_{O1} = I_{O2} = I_{O3} = 6A$ )



## Application Note 1712

### ISL9444EVAL1Z BOM

PART NUMBER	QTY	UNITS	REFERENCE DESIGNATOR	DESCRIPTION	MANUFACTURER	MANUFACTURER PART
ISL9444EVAL1ZREVAPCB	1	ea		PWB-PCB, ISL9444EVAL1Z, REVA, ROHS	IMAGINEERING INC	ISL9444EVAL1ZREVAPCB
H1045-00101-50V5-T	1	ea	CFF3	CAP, SMD, 0603, 100pF, 50V, 5%, COG, ROHS	PANASONIC	ECJ-1VC1H101J
H1045-00104-50V10-T	3	ea	CB1, CB2, CB3	CAP, SMD, 0603, 0.1µF, 50V, 10%, X7R, ROHS	TDK	C1608X7R1H104K
H1045-00105-50V10-T	1	ea	CBIAS	CAP, SMD, 0603, 1µF, 50V, 10%, X5R, ROHS	TDK	C1608X5R1H105K
H1045-00470-50V5-T	1	ea	CFF2	CAP, SMD, 0603, 47pF, 50V, 5%, COG, NPO, ROHS	AVX	06035A470JAT2A
H1045-00471-50V10-T	1	ea	CFF1	CAP, SMD, 0603, 470pF, 50V, 10%, X7R, ROHS	VENKEL	C0603X7R500-471KNE
H1045-00474-50V10-T	1	ea	CFIN	CAP, SMD, 0603, 0.47µF, 50V, 10%, X7R, ROHS	TDK	C1608X7R1H474K
H1045-00821-50V10-T	1	ea	CP1	CAP, SMD, 0603, 820pF, 50V, 10%, X7R, ROHS	KEMET	C0603C821K5RACTU
H1045-00821-50V5-T	3	ea	CL1, CL2, CL3	CAP, SMD, 0603, 820pF, 50V, 5%, COG, ROHS	KEMET	C0603C821J5GACTU
H1046-00103-16V10-T	3	ea	CSS1, CSS3, CDLY	CAP, SMD, 0805, 0.01µF, 16V, 10%, X7R, ROHS	KEMET	C0805C103K4RACTU
H1046-00106-6R3V10-T	1	ea	C017, C025, C034	CAP, SMD, 0805, 10µF, 6.3V, 10%, X5R, ROHS	VENKEL	C0805X5R6R3-106KNE
H1046-00475-16V10-T	1	ea	CVCC1	CAP, SMD, 0805, 4.7µF, 16V, 10%, X5R, ROHS	PANASONIC	ECJ-2FB1C475K
H1065-00106-35V10-T	4	ea	CIN2, CIN3, CIN5, CIN9	CAP, SMD, 1206, 10µF, 35V, 10%, X5R, ROHS	VENKEL	C1206X5R350-106KNE
H1065-00476-6R3V20-T	4	ea	C011, C012, C021, C031	CAP, SMD, 1206, 47µF, 6.3V, 20%, X5R, ROHS	MURATA	GRM31CR60J476ME19L
EEE-1VA101UAP-T	1	ea	CIN1	CAP, SMD, 8x10.2, 100µF, 35V, 20%, ALUM.ELEC., ROHS	PANASONIC	EEE-1VA101UAP
SPM6530T-1R0M120-T	1	ea	L1	COIL-PWR INDUCTOR, SMD, 7.1x6.5, 1.0µH, 20%, 12A, ROHS	TDK	SPM6530T-1R0M120
SPM6530T-1R5M100-T	2	ea	L2, L3	COIL-PWR INDUCTOR, SMD, 7.1x6.5, 1.5µH, 20%, 11A, ROHS	TDK	SPM6530T-1R5M100
1514-2	20	ea	TP1-TP14, TP17, TP16, TP19, TP20, TP21, TP22	CONN-TURRET, TERMINAL POST, TH, ROHS	KEYSTONE	1514-2
67996-272HLF-2X3	3	ea	J4, J5, J6	CONN-HEADER, 2x3, BREAKAWY 2x36, 2.54mm, VERTICAL, ROHS	BERG/FCI	67996-272HLF
68000-236HLF-1X3	1	ea	J3	CONN-HEADER, 1x3, BREAKAWY 1x36, 2.54mm, ROHS	BERG/FCI	68000-236HLF
SPC02SYAN	4	ea	J3, J4, J5, J6	CONN-JUMPER, SHORTING, 2PIN, BLACK, GOLD, ROHS	SULLINS	SPC02SYAN
ISL9444IRZ	1	ea	U1	IC-STEP-DOWN CONTROLLER, 40P, QFN, 5x5, ROHS	INTERSIL	ISL9444IRZ
IRF7907PBF	3	ea	M1, M2, M3	TRANSIST-DUALMOS, N-CHANNEL, 8P, SOIC, 30V, 9.1A, ROHS	INTERNATIONAL RECTIFIER	IRF7907PBF
H2511-001R2-1/10W1-T	3	ea	RL1, RL2, RL3	RES, SMD, 0603, 1.2Ω, 1/10W, 1%, TF, ROHS	PANASONIC	ERJ-3RQF1R2V



## Application Note 1712

### ISL9444EVAL1Z BOM (Continued)

PART NUMBER	QTY	UNITS	REFERENCE DESIGNATOR	DESCRIPTION	MANUFACTURER	MANUFACTURER PART
H2511-002R2-1/10W1-T	3	ea	R13, R14, R17	RES, SMD, 0603, 2.2Ω, 1/10W, 1%, TF, ROHS	PANASONIC	ERJ-3RQF2R2V
H2511-00R00-1/10W-T	5	ea	RFIN, R21, R23, R19, R20	RES, SMD, 0603, 0Ω, 1/10W, TF, ROHS	VENKEL	CR0603-10W-000T
H2511-01001-1/10W1-T	1	ea	RSEN3	RES, SMD, 0603, 1k, 1/10W, 1%, TF, ROHS	PANASONIC	ERJ-3EKF1001V
H2511-01003-1/10W1-T	3	ea	RPG1, RPG2, RPG3	RES, SMD, 0603, 100k, 1/10W, 1%, TF, ROHS	VENKEL	CR0603-10W-1003FT
H2511-01052-1/10W1-T	1	ea	R6	RES, SMD, 0603, 10.5k, 1/10W, 1%, TF, ROHS	YAGEO	RC0603FR-0710K5L
H2511-01153-1/10W1-T	1	ea	R8	RES, SMD, 0603, 115k, 1/10W, 1%, TF, ROHS	PANASONIC	ERJ-3EKF1153V
H2511-01212-1/10W1-T	1	ea	R5	RES, SMD, 0603, 12.1k, 1/10W, 1%, TF, ROHS	VENKEL	CR0603-10W-1212FT
H2511-01301-1/10W1-T	2	ea	RSEN1, RSEN2	RES, SMD, 0603, 1.3k, 1/10W, 1%, TF, ROHS	VISHAY/DALE	CRCW06031K30FKTA
H2511-01582-1/10W1-T	1	ea	R1	RES, SMD, 0603, 15.8 k, 1/10W, 1%, TF, ROHS	VENKEL	CR0603-10W-1582FT
H2511-01652-1/10W1-T	1	ea	R3	RES, SMD, 0603, 16.5k, 1/10W, 1%, TF, ROHS	PANASONIC	ERJ-3EKF1652V
H2511-03092-1/10W1-T	1	ea	R11	RES, SMD, 0603, 30.9k, 1/10W, 1%, TF, ROHS	YAGEO	RC0603FR-0730K9L
H2511-03162-1/10W1-T	1	ea	R2	RES, SMD, 0603, 31.6k, 1/10W, 1%, TF, ROHS	VISHAY	CRCW06033162F
H2511-04992-1/10W1-T	1	ea	RT	RES, SMD, 0603, 49.9k, 1/10W, 1%, TF, ROHS	VENKEL	CR0603-10W-4992FT
H2511-05112-1/10W1-T	1	ea	R4	RES, SMD, 0603, 51.1k, 1/10W, 1%, TF, ROHS	VENKEL	CR0603-10W-5112FT
H2511-08062-1/10W1-T	3	ea	ROC1, ROC2, ROC3	RES, SMD, 0603, 80.6k, 1/10W, 1%, TF, ROHS	PANASONIC	ERJ-3EKF8062V
5X8-STATIC-BAG	1	ea	Place assy in bag	BAG, STATIC, 5x8, ZIPLOC, ROHS	INTERSIL	212403-013
DNP	0	ea	R7, R9, R22	DO NOT POPULATE OR PURCHASE		
DNP	0	ea	a) CFF4, CIN4, CIN6, CIN7, CIN8, CIN10	DO NOT POPULATE OR PURCHASE		
DNP	0	ea	b) CP2, CP3, CSS2, C013, - C016, C018	DO NOT POPULATE OR PURCHASE		
DNP	0	ea	c) C019, C022, C023, C024, C032, C033	DO NOT POPULATE OR PURCHASE		
LABEL-DATE CODE	1	ea		LABEL-FOR DATE CODE AND BOM REV #	INTERSIL	LABEL-DATE CODE

Intersil Corporation reserves the right to make changes in circuit design, software and/or specifications at any time without notice. Accordingly, the reader is cautioned to verify that the Application Note or Technical Brief is current before proceeding.

For information regarding Intersil Corporation and its products, see [www.intersil.com](http://www.intersil.com)

# ISL9444EVAL1Z PCB Layout

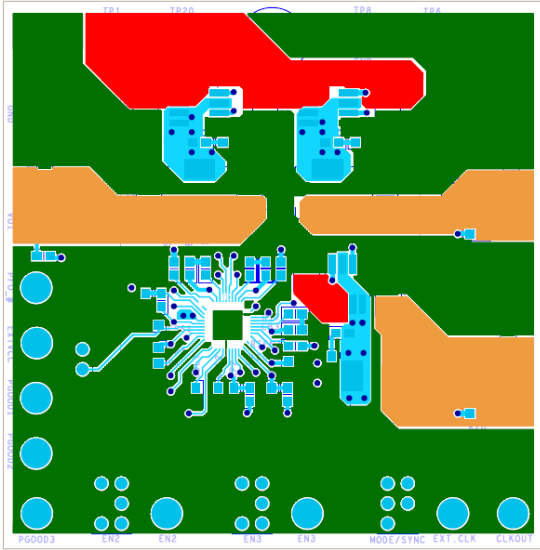

FIGURE 17. TOP LAYER

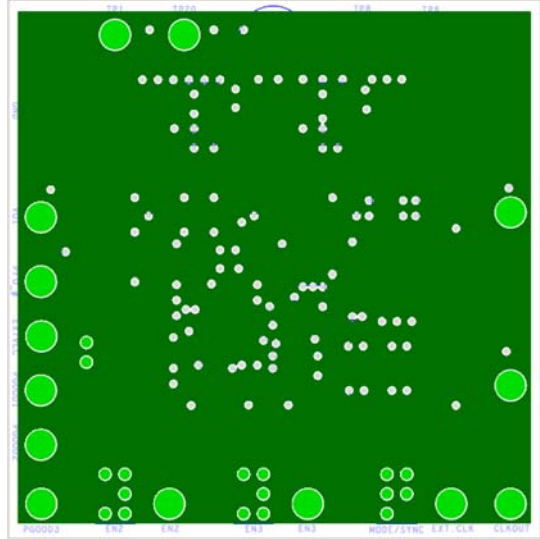

FIGURE 18. SECOND LAYER (SOLID GROUND)

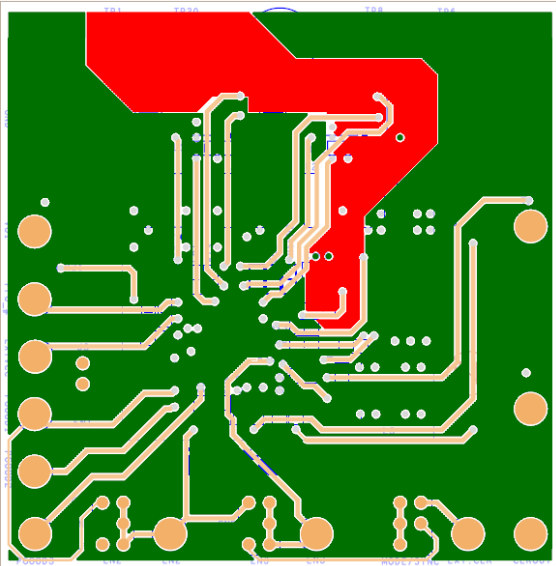

FIGURE 19. THIRD LAYER

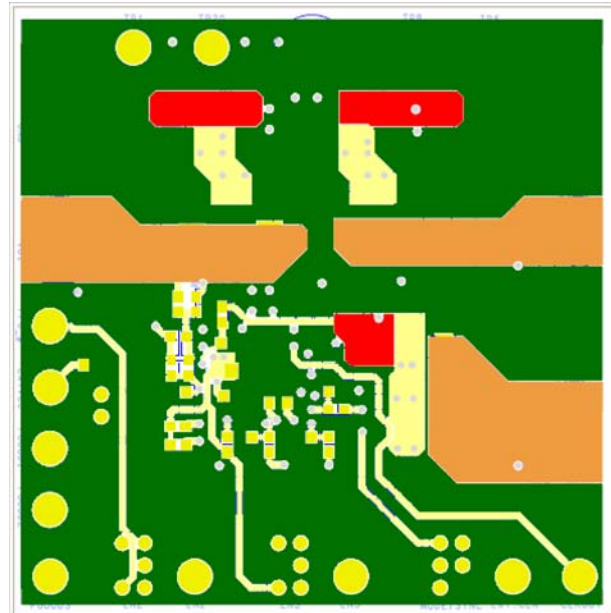

FIGURE 20. BOTTOM LAYER