



# XBee<sup>®</sup> 868LP

Radio Frequency (RF) Modules

---

User Guide

## Revision history—90002126

---

Revision	Date	Description
N	February 2016	Added the I/O Data Sample RX Indicator (0x92) frame to the API section. Corrected references to REC 70-03. Removed “865” from the guide.
P	July 2016	Updated pushbutton drawing and ISO spec number.
R	October 2016	Converted to the new MadCap Flare format with minor updates and added the information from the XBee 868LP Getting Started Guide (90002127).
S	June 2017	Modified regulatory and certification information as required by RED (Radio Equipment Directive).
T	May 2018	Added note on range estimation.

### Trademarks and copyright

Digi, Digi International, and the Digi logo are trademarks or registered trademarks in the United States and other countries worldwide. All other trademarks mentioned in this document are the property of their respective owners.

© 2018 Digi International Inc. All rights reserved.

### Disclaimers

Information in this document is subject to change without notice and does not represent a commitment on the part of Digi International. Digi provides this document “as is,” without warranty of any kind, expressed or implied, including, but not limited to, the implied warranties of fitness or merchantability for a particular purpose. Digi may make improvements and/or changes in this manual or in the product(s) and/or the program(s) described in this manual at any time.

### Warranty

To view product warranty information, go to the following website:

[www.digi.com/howtobuy/terms](http://www.digi.com/howtobuy/terms)

### Send comments

**Documentation feedback:** To provide feedback on this document, send your comments to [techcomm@digi.com](mailto:techcomm@digi.com).

### Customer support

**Digi Technical Support:** Digi offers multiple technical support plans and service packages to help our customers get the most out of their Digi product. For information on Technical Support plans and

pricing, contact us at +1 952.912.3444 or visit us at [www.digi.com/support](http://www.digi.com/support).

# Contents

---

## XBee 868LP RF Modules User Guide

XBee S8 hardware description .....	12
European acceptance .....	12

## Technical specifications

Performance specifications .....	14
LBT and AFA specifications .....	14
Power requirements .....	15
General specifications .....	15
Networking and security .....	16
Regulatory conformity summary .....	16
Serial communication specifications .....	16
UART pin assignments .....	16
SPI pin assignments .....	17
GPIO specifications .....	17
Hardware specifications for the programmable variant .....	17

## Hardware

Mechanical drawings .....	20
Pin signals .....	20
Design notes .....	22
Power supply design .....	22
Board layout .....	23
Antenna performance .....	23
Recommended pin connections .....	24
Design notes for PCB antenna devices .....	24
Design notes for RF pad devices .....	25
Module operation for the programmable variant .....	28
Programmable XBee SDK .....	29

## Get started

Set up the devices .....	31
Before you begin .....	31
Connect the hardware .....	32
Step 1: Download and install XCTU .....	33
Step 2: Set up your first wireless connection .....	35

Step 3: Create a mesh network .....	40
Step 4: Use API mode to talk to XBee modules .....	44
Do more with your XBee modules .....	48
Update the firmware .....	48
Configure remote devices .....	49
Set up and perform a range test .....	50
Configure basic synchronous sleep support .....	54
Set up basic encryption for an XBee network .....	59
Learn more about XBee module features .....	60
Unicast versus broadcast transmissions .....	60
Analog inputs and digital inputs and outputs .....	61
Sleep modes .....	61
Transparent and API operating modes .....	61
Troubleshooting .....	62
Cannot install device driver .....	62
Use LEDs to identify XBee modules .....	62
No remote devices to select for a range test .....	63
Port in use .....	63
XCTU cannot discover devices .....	64
XCTU cannot discover remote devices .....	65
XCTU cannot discover remote devices for a range test .....	65
XCTU installation error .....	65

## Configure the XBee 868LP RF Module

Software libraries .....	68
XBee Network Assistant .....	68

## Operation

Operation .....	70
Listen Before Talk and Automatic Frequency Agility .....	70
Single frequency mode band mode .....	71
Serial communications .....	71
UART data flow .....	71
SPI communications .....	72
SPI operation .....	73
Configuration considerations .....	75
Serial port selection .....	75
Data format .....	75
SPI parameters .....	76
Serial buffers .....	76
Serial receive buffer .....	76
Serial transmit buffer .....	76
UART flow control .....	76
CTS flow control .....	77
RTS flow control .....	77
Force UART operation .....	77
Condition .....	77
Solution .....	77
Serial interface protocols .....	77
Transparent operating mode .....	77
API operating mode .....	78
Comparing Transparent and API modes .....	78

## Modes

Transmit mode .....	81
Receive mode .....	81
Command mode .....	81
Enter Command mode .....	82
Troubleshooting .....	82
Send AT commands .....	82
Response to AT commands .....	83
Apply command changes .....	83
Make command changes permanent .....	83
Exit Command mode .....	83
Sleep mode .....	84

## Sleep modes

About sleep modes .....	86
Asynchronous modes .....	86
Synchronous modes .....	86
Normal mode .....	86
Asynchronous pin sleep mode .....	87
Asynchronous cyclic sleep mode .....	87
Asynchronous cyclic sleep with pin wake up mode .....	87
Synchronous sleep support mode .....	87
Synchronous cyclic sleep mode .....	87
Wake timer .....	88
Indirect messaging and polling .....	88
Indirect messaging .....	88
Polling .....	88
Sleeping routers .....	89
Sleep coordinator sleep modes in the DigiMesh network .....	89
Synchronization messages .....	89
Become a sleep coordinator .....	92
Select sleep parameters .....	94
Start a sleeping synchronous network .....	94
Add a new node to an existing network .....	95
Change sleep parameters .....	96
Rejoin nodes that lose sync .....	96
Diagnostics .....	97

## Advanced application features

Remote configuration commands .....	100
Send a remote command .....	100
Apply changes on remote devices .....	100
Remote command responses .....	100
Network commissioning and diagnostics .....	100
Configure devices .....	100
Network link establishment and maintenance .....	101
Place devices .....	102
Device discovery .....	103
Link reliability .....	103
Commissioning pushbutton and associate LED .....	106
I/O line monitoring .....	109

I/O samples .....	109
Queried sampling .....	109
Periodic I/O sampling .....	111
Detect digital I/O changes .....	112
General Purpose Flash Memory .....	112
Access General Purpose Flash Memory .....	112
Work with flash memory .....	113
General Purpose Flash Memory commands .....	114
PLATFORM_INFO_REQUEST (0x00) .....	114
PLATFORM_INFO (0x80) .....	114
ERASE (0x01) .....	115
ERASE_RESPONSE (0x81) .....	115
WRITE (0x02) and ERASE_THEN_WRITE (0x03) .....	116
WRITE_RESPONSE (0x82) and ERASE_THEN_WRITE_RESPONSE (0x83) .....	116
READ (0x04) .....	117
READ_RESPONSE (0x84) .....	118
FIRMWARE_VERIFY (0x05) and FIRMWARE_VERIFY_AND_INSTALL(0x06) .....	118
FIRMWARE_VERIFY_RESPONSE (0x85) .....	119
FIRMWARE_VERIFY_AND_INSTALL_RESPONSE (0x86) .....	119
Over-the-air firmware updates .....	120
Distribute the new application .....	120
Verify the new application .....	121
Install the application .....	121

## Networking methods

Directed Broadcast/Repeater mode .....	123
Point to Point/Multipoint mode .....	123
Permanent (dedicated) .....	123
Switched .....	123
DigiMesh networking .....	123
DigiMesh feature set .....	124
Networking concepts .....	125
Device Configuration .....	125
Network ID .....	125
Data transmission and routing .....	125
Unicast addressing .....	125
Broadcast addressing .....	125
Routing .....	126
Route discovery .....	126
DigiMesh throughput .....	126
Transmission timeouts .....	127

## AT commands

Special commands .....	130
AC (Apply Changes) .....	130
FR (Software Reset) .....	130
RE command .....	130
WR command .....	130
MAC/PHY commands .....	131
CM (Channel Mask) .....	131
HP (Preamble ID) .....	131
ID (Network ID) .....	131

MT (Broadcast Multi-Transmits) .....	132
PL (TX Power Level) .....	132
RR (Unicast Mac Retries) .....	132
ED (Energy Detect) .....	133
Diagnostic commands .....	133
BC (Bytes Transmitted) .....	133
DB (Last Packet RSSI) .....	133
ER (Received Error Count) .....	134
GD (Good Packets Received) .....	134
EA (MAC ACK Timeouts) .....	134
TR (Transmission Errors) .....	134
UA (MAC Unicast Transmission Count) .....	135
%H (MAC Unicast One Hop Time) .....	135
%8 (MAC Broadcast One Hop Time) .....	135
Network commands .....	135
CE (Node Messaging Options) .....	135
BH command .....	136
NH (Network Hops) .....	136
NN (Network Delay Slots) .....	136
MR (Mesh Unicast Retries) .....	137
Addressing commands .....	137
SH command .....	137
SL command .....	137
DH command .....	138
DL command .....	138
TO command .....	138
NI command .....	139
NT (Node Discover Timeout) .....	139
NO (Node Discovery Options) .....	139
CI (Cluster ID) .....	140
DE command .....	140
SE command .....	140
Addressing discovery/configuration commands .....	141
AG (Aggregator Support) .....	141
DN (Discover Node) .....	141
ND (Network Discover) .....	141
FN (Find Neighbors) .....	142
Diagnostic - addressing commands .....	142
N? (Network Discovery Timeout) .....	143
Security commands .....	143
EE (Security Enable) .....	143
KY (AES Encryption Key) .....	143
Serial interfacing commands .....	144
BD (Baud Rate) .....	144
NB (Parity) .....	144
SB command .....	145
RO command .....	145
FT (Flow Control Threshold) .....	145
API Mode .....	146
AO command .....	146
I/O settings commands .....	146
CB command .....	146
D0 (AD0/DIO0 Configuration) .....	147
D1 (DIO1/AD1) .....	147
D2 (DIO2/AD2) .....	148



D3 (DIO3/AD3)	148
D4 (DIO4/AD4)	148
D5 (DIO5/ASSOCIATED_INDICATOR)	149
D6 (DIO6/RTS)	149
D7 (DIO7/CTS)	150
D8 (DIO8/SLEEP_REQUEST)	150
D9 (DIO9/ON_SLEEP)	151
P0 (DIO10/RSSI/PWM0 Configuration)	151
P1 (DIO11/PWM1 Configuration)	151
P2 (DIO12 Configuration)	152
P3 (DIO13/DOUT)	152
P4 (DIO14/DIN)	153
P5 (SPI_MISO)	153
P6 (SPI_MOSI Configuration)	153
P7 (DIO17/SPI_SSEL)	154
P8 (DIO18/SPI_SCLK)	154
P9 (SPI_ATTN)	154
PD (Pull Up/Down Direction)	155
PR (Pull-up/Down Resistor Enable)	155
M0 (PWM0 Duty Cycle)	156
M1 (PWM1 Duty Cycle)	156
LT command	157
RP command	157
I/O sampling commands	157
AV (Analog Voltage Reference)	157
IC (DIO Change Detection)	157
IF (Sleep Sample Rate)	158
IR (I/O Sample Rate)	159
TP (Temperature)	159
IS command	159
%V (Voltage Supply Monitoring)	159
Sleep commands	160
SM command	160
SO command	160
SN command	161
SP (Sleep Period)	161
ST (Wake Time)	161
WH (Wake Host)	162
Diagnostic - sleep status/timing commands	162
SS (Sleep Status)	162
OS (Operating Sleep Time)	163
OW (Operating Wake Time)	163
MS (Missed Sync Messages)	163
SQ (Missed Sleep Sync Count)	163
Command mode options	164
CC (Command Sequence Character)	164
CT command	164
CN command	164
GT command	164
Firmware commands	165
VL command	165
VR command	165
HV command	165
HS (Hardware Series)	165
DD command	165

NP (Maximum Packet Payload Bytes) .....	166
CK (Configuration CRC) .....	166

## Operate in API mode

API mode overview .....	168
API frame format .....	168
Data bytes that need to be escaped: .....	169
Calculate and verify checksums .....	170
API frame exchanges .....	171
Code to support future API frames .....	172
Frame data .....	173
AT Command frame - 0x08 .....	174
AT Command - Queue Parameter Value frame - 0x09 .....	175
Transmit Request frame - 0x10 .....	177
Explicit Addressing Command frame - 0x11 .....	180
Remote AT Command Request frame - 0x17 .....	183
AT Command Response frame - 0x88 .....	185
Modem Status frame - 0x8A .....	187
Transmit Status frame - 0x8B .....	188
Route Information Packet frame - 0x8D .....	190
Aggregate Addressing Update frame - 0x8E .....	193
Receive Packet frame - 0x90 .....	195
Explicit Rx Indicator frame - 0x91 .....	197
Data Sample Rx Indicator frame - 0x92 .....	199
Node Identification Indicator frame - 0x95 .....	202
Remote Command Response frame - 0x97 .....	205

## Migrate from XBee through-hole to surface-mount devices

Pin mapping .....	208
Mounting .....	209

## Manufacturing information

Recommended solder reflow cycle .....	212
Recommended footprint .....	212
Flux and cleaning .....	214
Reworking .....	215

## Regulatory information

Europe .....	217
Maximum power and frequency specifications .....	217
OEM labeling requirements .....	218
Declarations of conformity .....	219
Antennas .....	219

## **XBee 868LP RF Modules User Guide**

---

The Digi XBee 868LP RF Modules provide wireless connectivity to end-point devices in mesh networks. With the XBee, users can have their network up-and-running in a matter of minutes without configuration or additional development. The Digi XBee 868LP RF Module consists of firmware loaded onto Digi XBee S8 hardware.

You can build networks up to 128 nodes using the XBee modules. For larger networks up to 1000+ nodes, Digi offers RF Optimization Services to assist with proper network configuration. Contact Digi Technical Support for more details.

---

**Note** The Digi XBee 868LP RF Modules are not compatible with other XBee products.

---

XBee S8 hardware description .....	12
European acceptance .....	12

## **XBee S8 hardware description**

The XBee S8 radio module hardware consists of an Energy Micro EFM<sup>®</sup>32G230F128 microcontroller, an Analog Devices ADF7023 radio transceiver, and in the Programmable version, a NXP MC9S08QE32 microcontroller.

## **European acceptance**

The Digi XBee 868LP is manufactured under ISO 900:2015 registered standards.

The Digi XBee 868LP RF Modules are optimized for use in Europe and other regions. For more information, see [Regulatory information](#).

## Technical specifications

---

Performance specifications .....	14
LBT and AFA specifications .....	14
Power requirements .....	15
General specifications .....	15
Networking and security .....	16
Regulatory conformity summary .....	16
Serial communication specifications .....	16
GPIO specifications .....	17
Hardware specifications for the programmable variant .....	17

## Performance specifications

The following table describes the performance specifications for the devices.

**Note** Range figure estimates are based on free-air terrain with limited sources of interference. Actual range will vary based on transmitting power, orientation of transmitter and receiver, height of transmitting antenna, height of receiving antenna, weather conditions, interference sources in the area, and terrain between receiver and transmitter, including indoor and outdoor structures such as walls, trees, buildings, hills, and mountains.

Specification	XBee		
Indoor/urban range	Up to 370 ft (112 m) with a 2.1 dBi antenna, up to 46 ft (14 m) with a PCB embedded antenna.		
Outdoor RF line-of-sight range	Up to 5.2 miles (8.4 km) with a 2.1 dBi antenna, up to 0.4 miles (.64 km) with a PCB embedded antenna.		
Transmit power output	Up to 14 dBm (25 mW) EIRP with 2.1 dBi antenna		
RF data rate (high)	80 kb/s		
RF data rate (low)	10 kb/s		
UART interface	Complementary metal-oxide-semiconductor (CMOS) serial universal asynchronous receiver/transmitter (UART), baud rate stability of <1%.		
UART data rate (software selectable)	9600-230400 baud		
SPI clock rate	Up to 3.5 MHz		
Receiver sensitivity (typical)	-101 dBm @ 80 kb/s, -106 dBm @ 10 kb/s.		
Receiver blocking (typical)			
		10 kb/s	80 kb/s
	+/- 400 kHz	40 dB	35 dB
	+/- 200 kHz	35 dB	29 dB

**Note** To determine your indoor/urban range or outdoor RF line-of-sight range, perform a range test under your operating conditions.

## LBT and AFA specifications

The following table provides the Listen Before Talk (LBT) and Adaptive Frequency Agility (AFA) specifications.

Specification	XBee 868LP
Channel spacing	100 kHz
Receiver bandwidth	150 kHz
Modulation bandwidth	< 300 kHz
LBT threshold	< -88 dBm
TX on time	< 1 second

## Power requirements

The following table describes the power requirements for the XBee 868LP RF Module.

Specification	XBee
Supply voltage ( $V_{DD}$ )	2.7 to 3.6 VDC
Transmit current, high data rate	48 mA, (45 mA typical)
Transmit current, low data rate	47 mA (41 mA typical)
Idle / receive current (high data rate)	27 mA (22 mA typical)
Idle / receive current (low data rate)	26 mA (24 mA typical)
Sleep current	1.7 $\mu$ A

## General specifications

The following table describes the general specifications for the devices.

Specification	XBee
Operating frequency band	863 to 870 MHz for Europe
Dimensions	2.119 x 3.4 x 0.305 cm (0.866 x 1.333 x 1.2 in)
Weight	40 g (1.4 oz)
Operating temperature	-40 °C to 85 °C (industrial)
Antenna options	U.FL RF connector, RF pad, embedded PCB antenna.  <b>Note</b> The embedded PCB antenna is only approved with 10 kb/s data rate, not 80 kb/s data rate.
Digital I/O	13 I/O lines, five dedicated to Serial Peripheral Interface (SPI) that can be used as digital outputs.
ADC	4 10-bit analog inputs

## Networking and security

The following table describes the networking and security specifications for the devices.

Specification	XBee
Supported network topologies	Mesh, repeater, point-to-point, point-to-multipoint, peer-to-peer.
Number of channels, user selectable channels	30 channels, LBT + AFA
Addressing options	Personal Area Network identifier (PAN ID) and 64-bit addresses.
Encryption	128 bit Advanced Encryption Standard (AES)

**Note** For more information about the number of user selectable channels, see [OEM labeling requirements](#) for countries in the European Community.

## Regulatory conformity summary

This table describes the agency approvals for the devices.

Specification	XBee
Europe (CE)	Yes

## Serial communication specifications

The XBee 868LP RF Module supports both Universal Asynchronous Receiver / Transmitter (UART) and Serial Peripheral Interface (SPI) serial connections.

### UART pin assignments

UART Pins	Device Pin Number
DOUT	3
DIN / $\overline{\text{CONFIG}}$	4
$\overline{\text{CTS}}$ / DIO7	25
$\overline{\text{RTS}}$ / DIO6	29

For more information on UART operation, see [UART data flow](#).



## SPI pin assignments

SPI Pins	Module Pin Number
SPI_SCLK / DIO18 (input)	14
SPI_SSEL / DIO17 (input)	15
SPI_MOSI / DIO16 (input)	16
SPI_MISO / DIO15 (output/tri-stated)	17
SPI_ATTN (output)	12

For more information on SPI operation, see [SPI communications](#).

## GPIO specifications

The XBee 868LP RF Modules have General Purpose Input / Output (GPIO) ports available. The exact list depends on the module configuration, as some GPIO pads are used for purposes such as serial communication.

You can set the pin configuration by using D0-D9, P0-P9, and I/O line monitoring. You cannot sample pins P5-P9, but you may use them as outputs. For more information on these commands, see [AT commands](#). For more information on configuring and using GPIO ports, see [Pin signals](#).

The following table provides the electrical specifications for the GPIO pads.

GPIO electrical specification	Value
Low Schmitt switching threshold	$0.3 \times V_{DD}$
High Schmitt switching threshold	$0.7 \times V_{DD}$
Input pull-up resistor value	40 k $\Omega$
Input pull-down resistor value	40 k $\Omega$
Output voltage for logic 0	$0.05 \times V_{DD}$
Output voltage for logic 1	$0.95 \times V_{DD}$
Output source current	6 mA
Output sink current	6 mA
Total output current (for GPIO pads)	48 mA

## Hardware specifications for the programmable variant

If the module includes the programmable secondary processor, add the following table values to the specifications listed in [Pin signals](#), [Serial communication specifications](#), and [GPIO specifications](#). For example, if the secondary processor is running at 20 MHz and the primary processor is in receive mode, then the new current value will be  $I_{total} = I_{r2} + I_{rx} = 14 \text{ mA} + 9 \text{ mA} = 23 \text{ mA}$ , where  $I_{r2}$  is the runtime current of the secondary processor and  $I_{rx}$  is the receive current of the primary.

The following table provides the specifications of the programmable secondary processor.

Optional secondary processor specification	Add to RX, TX, and sleep currents specifications depending on mode of operation
Runtime current for 32 k running at 20 MHz	+14 mA
Runtime current for 32 k running at 1 MHz	+1 mA
Sleep current	+0.5 $\mu$ A typical
$V_{REF}$ Range	1.8 VDC to $V_{DD}$
Microcontroller	NXP Flexis 8-bit S08 microcontroller <a href="#">NXP S08QE Family</a> Part number: <a href="#">MC9S08QE32</a>

## Hardware

---

Mechanical drawings .....	20
Pin signals .....	20
Design notes .....	22
Module operation for the programmable variant .....	28
Programmable XBee SDK .....	29

## Mechanical drawings

The following mechanical drawings of the XBee 868LP RF Modules show all dimensions in inches. Antenna options are not shown.

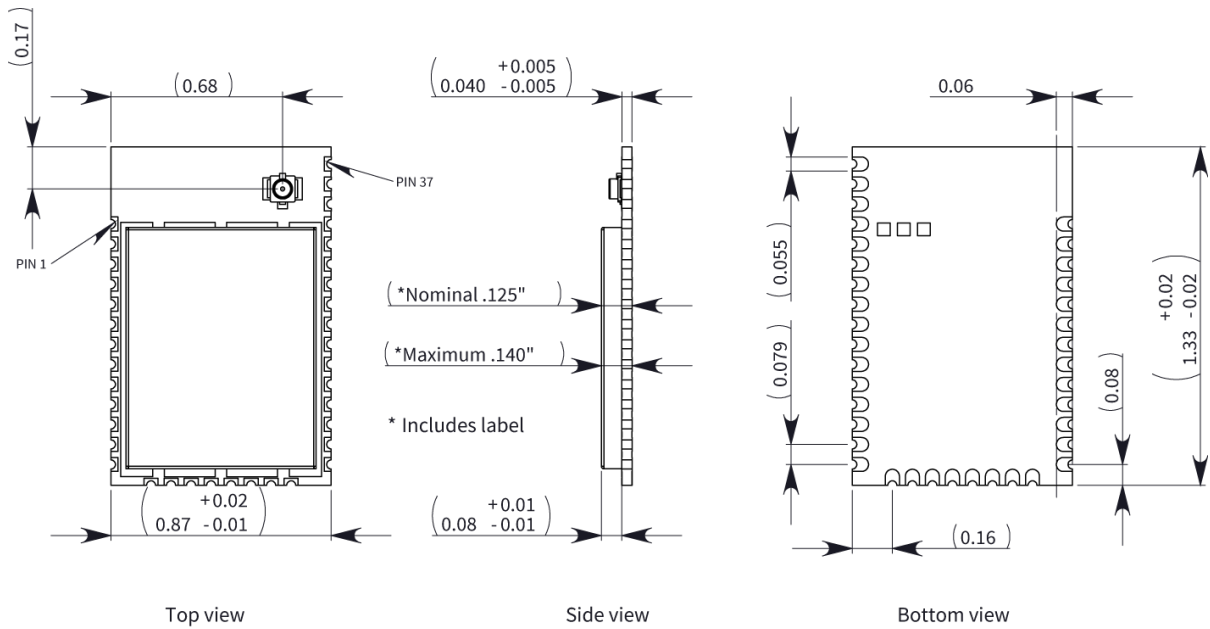

## Pin signals

The following table describes the pin assignments for the devices. A horizontal line above the signal name indicates low-asserted signals.

Pin#	Name	Direction	Default state	Description
1	GND	-	-	Ground
2	V <sub>DD</sub>	-	-	Power supply
3	DIO13 / DOUT	Both	Output	GPIO/UART Data Out
4	DIO14 / DIN / $\overline{\text{CONFIG}}$	Both	Input	GPIO/UART Data In
5	DIO12	Both		GPIO
6	$\overline{\text{RESET}}$	Input		Module reset. Drive low to reset the module. This is also an output with an open drain configuration with an internal 20 kW pull-up (never drive to logic high, as the module may be driving it low). The minimum pulse width is 1 mS.

Pin#	Name	Direction	Default state	Description
7	DIO10 / RSSI PWM0	Both	Output	GPIO/RX Signal Strength Indicator
8	DIO11 / PWM1	Both	Disabled	GPIO/Pulse Width Modulator
9	[reserved]	-	Disabled	Do not connect
10	DIO8 / SLEEP_REQUEST	Both	Input	GPIO/Pin Sleep Control Line (DTR on the dev board)
11	GND	-	-	Ground
12	DIO19 / SPI_ATT $\overline{\text{N}}$	Output	Output	Serial Peripheral Interface Attention or UART Data Present indicator
13	GND	-	-	Ground
14	DIO18 / SPI_CLK	Input	Input	GPIO/Serial Peripheral Interface Clock/
15	DIO17 / SPI_SSEL/	Input	Input	GPIO/Serial Peripheral Interface not Select
16	DIO16 / SPI_MOSI	Input	Input	GPIO/Serial Peripheral Interface Data In
17	DIO15 / SPI_MISO/	Output	Output	GPIO/Serial Peripheral Interface Data Out Tri-stated when SPI_SSEL is high
18	[reserved]*	-	Disabled	Do not connect
19	[reserved]*	-	Disabled	Do not connect
20	[reserved]*	-	Disabled	Do not connect
21	[reserved]*	-	Disabled	Do not connect
22	GND	-	-	Ground
23	[reserved]	-	Disabled	Do not connect
24	DIO4	Both	Disabled	GPIO
25	DIO7 / CTS/	Both	Output	GPIO/Clear to Send Flow Control
26	ON/SLEEP/DIO9	Both	Output	GPIO/Module Status Indicator

Pin#	Name	Direction	Default state	Description
27	VREF	Input	-	Not used internally. Used for programmable secondary processor. For compatibility with other XBee modules, we recommend connecting this pin to the voltage reference if Analog Sampling is desired. Otherwise, connect to GND.
28	DIO5 / ASSOCIATE/	Both	Output	GPIO/Associate Indicator
29	DIO6 / $\overline{\text{RTS}}$	Both	Input	GPIO/Request to Send Flow Control
30	DIO3 / AD3	Both	Disabled	GPIO/Analog Input
31	DIO2 / AD2	Both	Disabled	GPIO/Analog Input
32	DIO1 / AD1	Both	Disabled	GPIO/Analog Input
33	DIO0 / AD0	Both	Input	GPIO/Analog Input
34	[reserved]	-	Disabled	Do not connect
35	GND	-	-	Ground
36	RF	Both	-	RF I/O for RF Pad Variant
37	[reserved]	-	Disabled	Do not connect
Signal Direction is specified with respect to the device. See <a href="#">Design notes</a> for details on pin connections. * These pins are not available for customer use.				

## Design notes

The XBee modules do not require any external circuitry or specific connections for proper operation. However, there are some general design guidelines that we recommend to build and troubleshoot a robust design.

### Power supply design

A poor power supply can lead to poor radio performance, especially if you do not keep the supply voltage within tolerance or if the noise is excessive. To help reduce noise, place a 1.0  $\mu\text{F}$  and 47 pF capacitor as near as possible to pin 2 on the PCB. If you are using a switching regulator for the power supply, switch the frequencies above 500 kHz. Limit the power supply ripple to a maximum 250 mV peak to peak.

For designs using the programmable modules, we recommend an additional 10  $\mu\text{F}$  decoupling cap near pin 2 of the device. The nearest proximity to pin 2 of the three caps should be in the following order:

1. 47 pF
2. 1  $\mu$ F
3. 10  $\mu$ F

## Board layout

We design XBee modules to be self-sufficient and have minimal sensitivity to nearby processors, crystals or other printed circuit board (PCB) components. Keep power and ground traces thicker than signal traces and make sure that they are able to comfortably support the maximum current specifications. There are no other special PCB design considerations to integrate XBee modules, with the exception of antennas.

To view a recommended PCB footprint for the module, see [Manufacturing information](#).

## Antenna performance

Antenna location is important for optimal performance. The following suggestions help you achieve optimal antenna performance. Point the antenna up vertically (upright). Antennas radiate and receive the best signal perpendicular to the direction they point, so a vertical antenna's omnidirectional radiation pattern is strongest across the horizon.

Position the antennas away from metal objects whenever possible. Metal objects between the transmitter and receiver can block the radiation path or reduce the transmission distance. Objects that are often overlooked include:

- Metal poles
- Metal studs
- Structure beams
- Concrete, which is usually reinforced with metal rods

If you place the device inside a metal enclosure, use an external antenna. Common objects that have metal enclosures include:

- Vehicles
- Elevators
- Ventilation ducts
- Refrigerators
- Microwave ovens
- Batteries
- Tall electrolytic capacitors

Use the following additional guidelines for optimal antenna performance:

- Do not place XBee modules with the chip antenna inside a metal enclosure.
- Do not place any ground planes or metal objects above or below the antenna.
- For the best results, mount the device at the edge of the host PCB. Ensure that the ground, power, and signal planes are vacant immediately below the antenna section.

## Recommended pin connections

The only required pin connections for two-way communication are VDD, GND, DOUT and DIN. To support serial firmware updates, you must connect VDD, GND, DOUT, DIN, RTS, and DTR.

Do not connect any pins that are not in use. Use the **PR** and **PD** commands to pull all inputs on the radio high or low with 40k internal pull-up or pull-down resistors. Unused outputs do not require any specific treatment.

For applications that need to ensure the lowest sleep current, never leave unconnected inputs floating. Use internal or external pull-up or pull-down resistors, or set the unused I/O lines to outputs.

You can connect other pins to external circuitry for convenience of operation including the Associate LED pad (pad 28) and the Commissioning pad (pad 33). The Associate LED pad flashes differently depending on the state of the module to the network, and a pushbutton attached to pad 33 can enable various join functions without having to send serial port commands. For more information see [Commissioning pushbutton and associate LED](#). The source and sink capabilities are limited to 6 mA on all I/O pads.

Only the programmable versions of these devices use the VREF pad (pad 27). For compatibility with other XBee modules, we recommend connecting this pin to a voltage reference if you want to enable analog sampling. Otherwise, connect to GND.

## Design notes for PCB antenna devices

Position PCB antenna devices so there are no ground planes or metal objects above or below the antenna. For best results, do not place the device in a metal enclosure, as this may greatly reduce the range. Place the device at the edge of the PCB on which it is mounted. Make sure the ground, power and signal planes are vacant immediately below the antenna section.

The following drawings illustrate important recommendations when you are designing with PCB antenna devices. For optimal performance, do not mount the device on the RF pad footprint described in the next section, because the footprint requires a ground plane within the PCB antenna keep out area.





Following good design practices is essential when implementing the RF trace on a PCB. Consider the following points:

- Minimize the length of the trace by placing the RPSMA jack close to the device.
- Connect all of the grounds on the jack and the device to the ground planes directly or through closely placed vias.
- Space any ground fill on the top layer at least twice the distance  $d$  (in this case, at least 0.028") from the microstrip to minimize their interaction.

Additional considerations:

- The top two layers of the PCB have a controlled thickness dielectric material in between.
- The second layer has a ground plane which runs underneath the entire RF pad area. This ground plane is a distance  $d$ , the thickness of the dielectric, below the top layer.
- The top layer has an RF trace running from pin 33 of the device to the RF pin of the RPSMA connector.
- The RF trace width determines the impedance of the transmission line with relation to the ground plane. Many online tools can estimate this value, although you should consult the PCB manufacturer for the exact width.

Implementing these design suggestions helps ensure that the RF pad device performs to its specifications.

The following figures show a layout example of a host PCB that connects an RF pad device to a right angle, through-hole RPSMA jack.

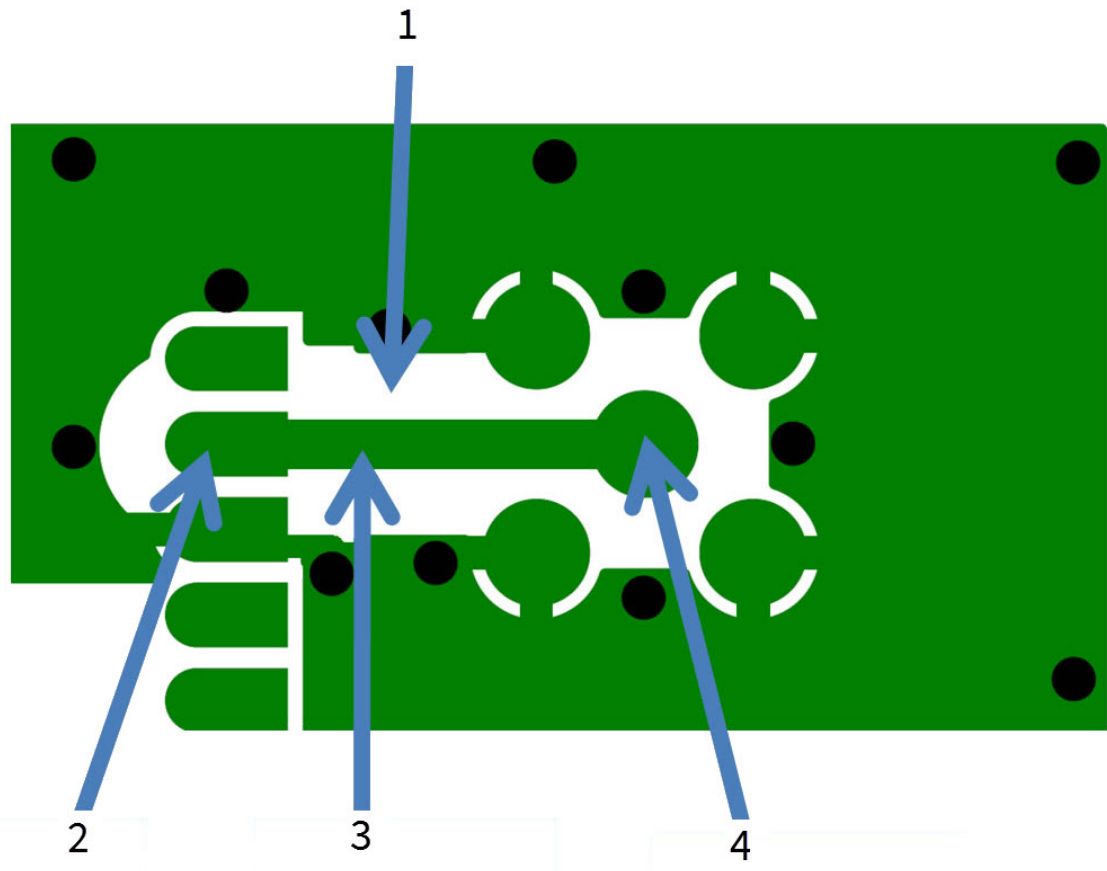

Number	Description
1	Maintain a distance of at least 2 d between microstrip and ground fill.
2	Device pin 33.
2	RF pad pin.
3	50 Ω microstrip trace.
4	RF connection of RPSMA jack.

The width in this example is approximately 0.025 in for a 50 Ω trace, assuming d = 0.014 in, and that the dielectric has a relative permittivity of 4.4. This trace width is a good fit with the device footprint's 0.335" pad width.

**Note** We do not recommend using a trace wider than the pad width, and using a very narrow trace (under 0.010") can cause unwanted RF loss.

The following illustration shows PCB layer 2 of an example RF layout.

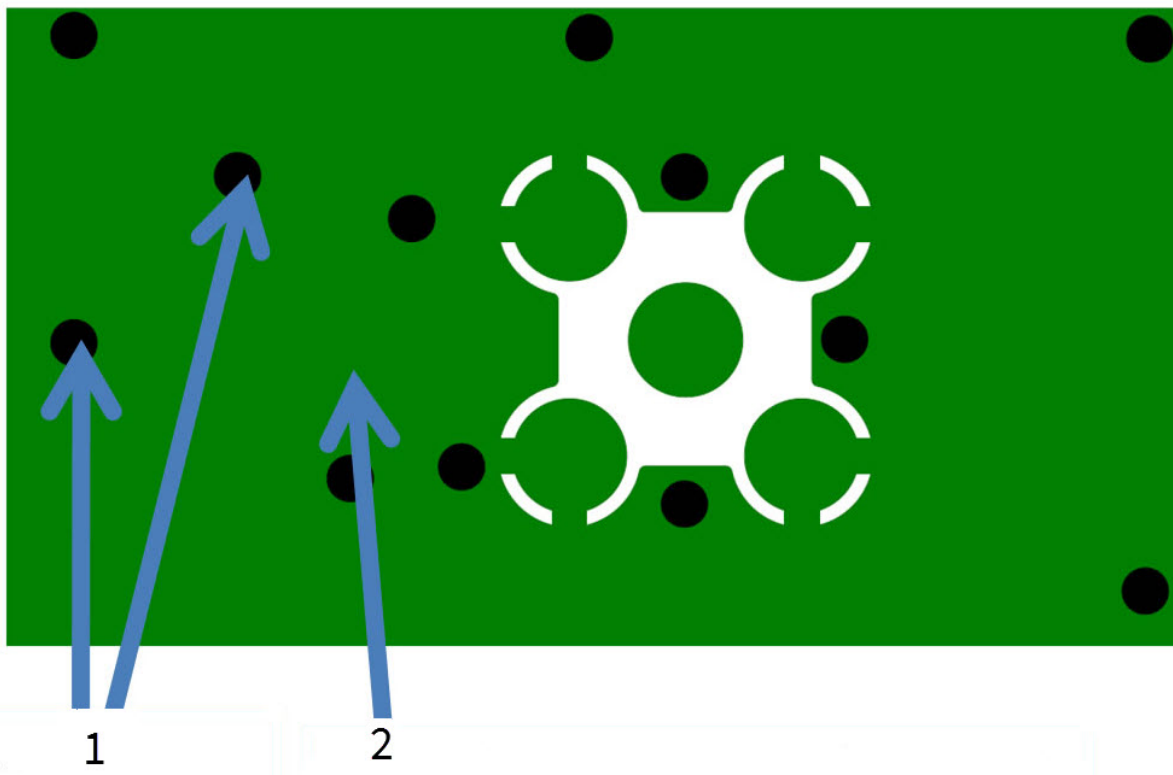

Number	Description
1	Use multiple vias to help eliminate ground variations.
2	Put a solid ground plane under RF trace to achieve the desired impedance.

## Module operation for the programmable variant

The modules with the programmable option have a secondary processor with 32k of flash and 2k of RAM. This allows module integrators to put custom code on the XBee module to fit their own unique needs. The DIN, DOUT, RTS, CTS, and RESET lines are intercepted by the secondary processor to allow it to be in control of the data transmitted and received. All other lines are in parallel and can be controlled by either the internal microcontroller or the MC9S08QE micro; see the block diagram in [Operation](#) for details. The internal microcontroller by default has control of certain lines. The internal microcontroller can release these lines by sending the proper command(s) to disable the desired DIO line(s). For more information about commands, see [AT commands](#).

For the secondary processor to sample with ADCs, the XBee must be connected to a reference voltage.

Digi provides a bootloader that can take care of programming the processor over-the-air or through the serial interface. This means that over-the-air updates can be supported through an XMODEM protocol. The processor can also be programmed and debugged through a one wire interface BKGD.

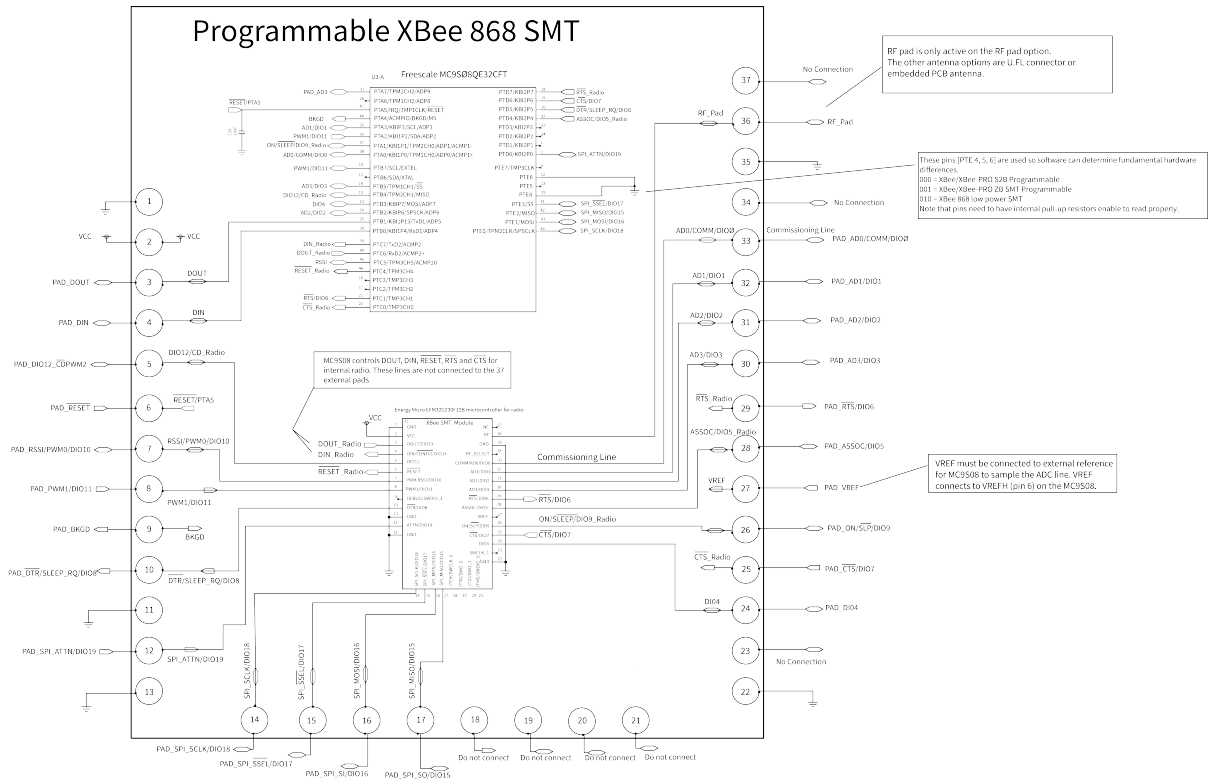

## Programmable XBee SDK

The XBee Programmable module is equipped with a NXP MC9S08QE32 application processor. This application processor comes with a supplied bootloader. To interface your application code running on this processor to the XBee Programmable module's supplied bootloader, use the Programmable XBee SDK.

To use the SDK, you must also download CodeWarrior. The download links are:

- CodeWarrior IDE: [http://ftp1.digi.com/support/sampleapplications/40003004\\_B.exe](http://ftp1.digi.com/support/sampleapplications/40003004_B.exe)
- Programmable XBee SDK: [http://ftp1.digi.com/support/sampleapplications/40003003\\_D.exe](http://ftp1.digi.com/support/sampleapplications/40003003_D.exe)

If these revisions change, search for the part number on Digi's website. For example, search for **40003003**.

Install the IDE first, and then install the SDK.

The documentation for the Programmable XBee SDK is built into the SDK, so the Getting Started guide appears when you open CodeWarrior.

## Get started

---

The XBee 868LP RF Modules support low-power, peer-to-peer or wireless mesh networks for Europe (868 MHz). The XBee 868LP RF Modules provide reliable delivery of data between remote devices.

This guide shows you how to set up a mesh network using the DigiMesh protocol, send data between devices, and adjust XBee 868LP RF Module settings.

---

**Note** For more information about DigiMesh protocol and features, see [DigiMesh networking](#).

---

This guide covers the following tasks and features:

Set up the devices .....	31
Do more with your XBee modules .....	48
Learn more about XBee module features .....	60
Troubleshooting .....	62

## Set up the devices

### Before you begin

To get started with your XBee RF module development kit, verify that your kit has all of the components and that you meet the system requirements.

### Verify kit contents

The XBee 868LP RF Module development kit contains the following components:

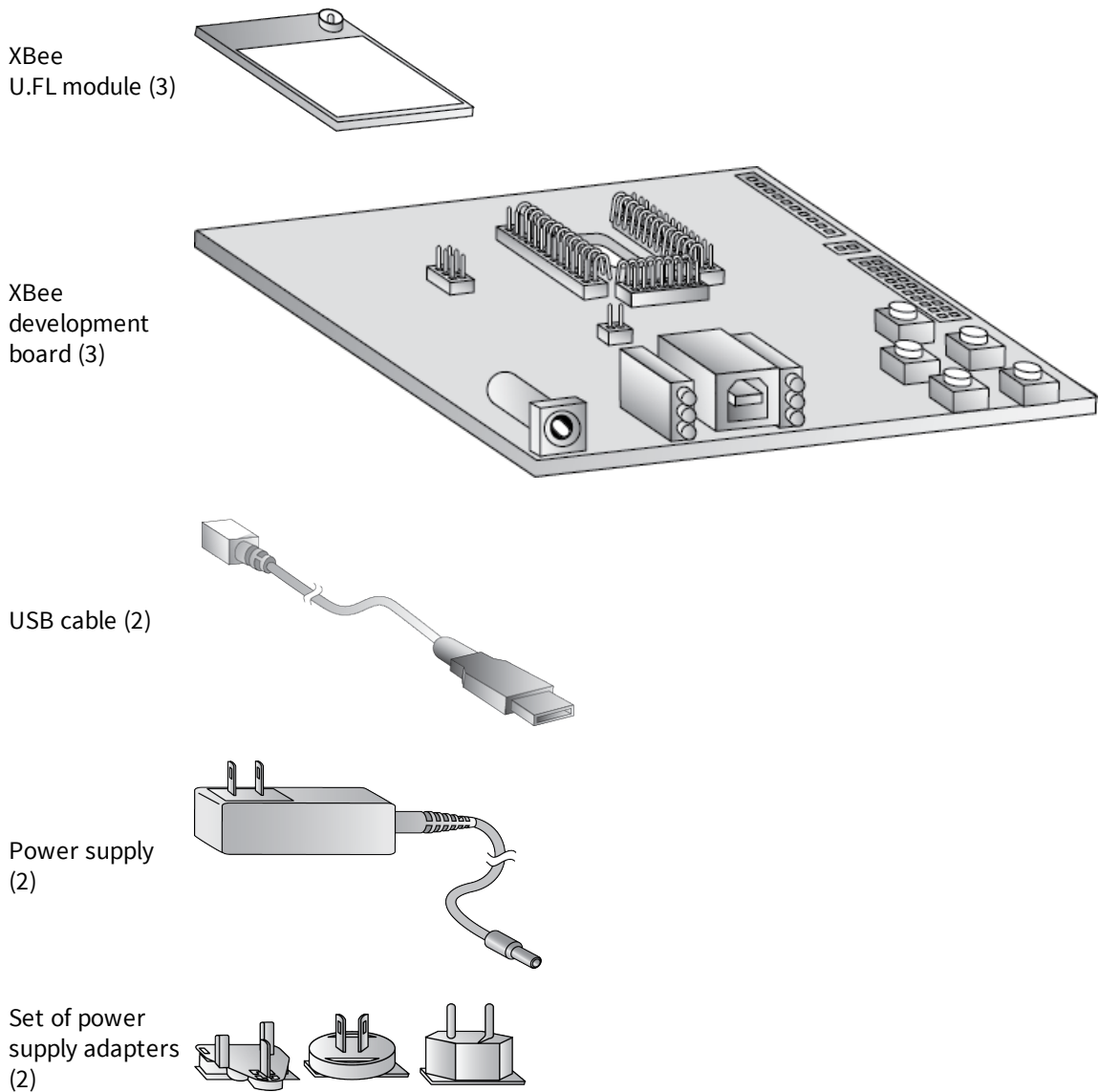

Antenna U.FL (3)



### Gather required materials

To complete the steps in this guide, you need the following items:

Item	Description
Computer	<p>Operating systems:</p> <ul style="list-style-type: none"> <li>■ Windows Vista/7/8 (32-bit or 64-bit versions)</li> <li>■ Mac OS X v10.6 and higher versions (64-bit only)</li> <li>■ Linux with KDE or GNOME window managers (32-bit or 64-bit versions)</li> </ul> <p>System requirements:</p> <ul style="list-style-type: none"> <li>■ HDD space: 500 MB minimum, 1GB recommended</li> <li>■ RAM memory: 2 GB minimum, 4 GB recommended</li> <li>■ CPU: Dual-core processor minimum, Quad-core processor recommended</li> </ul> <p>USB ports:</p> <ul style="list-style-type: none"> <li>■ Three available USB ports for the XBee/XBee-PRO DigiMesh 2.4 development kit</li> <li>■ Two available USB ports for the XBee 868LP development kit</li> </ul> <p><b>Note</b> Only one computer is required to follow along with the steps in this guide. However, you can use two or more computers—one for each XBee module. For range testing, we recommend a laptop.</p>
XCTU software	Version 6.1.3 or later. See <a href="#">Download and install XCTU</a> .
USB drivers	Windows Vista and later: USB drivers automatically install through plug-and-play. Windows XP and earlier: You need to download the driver software. See <a href="#">Optional: Manually install USB drivers</a> .

### Connect the hardware

The following illustration shows you how to assemble the hardware components of the development kit.



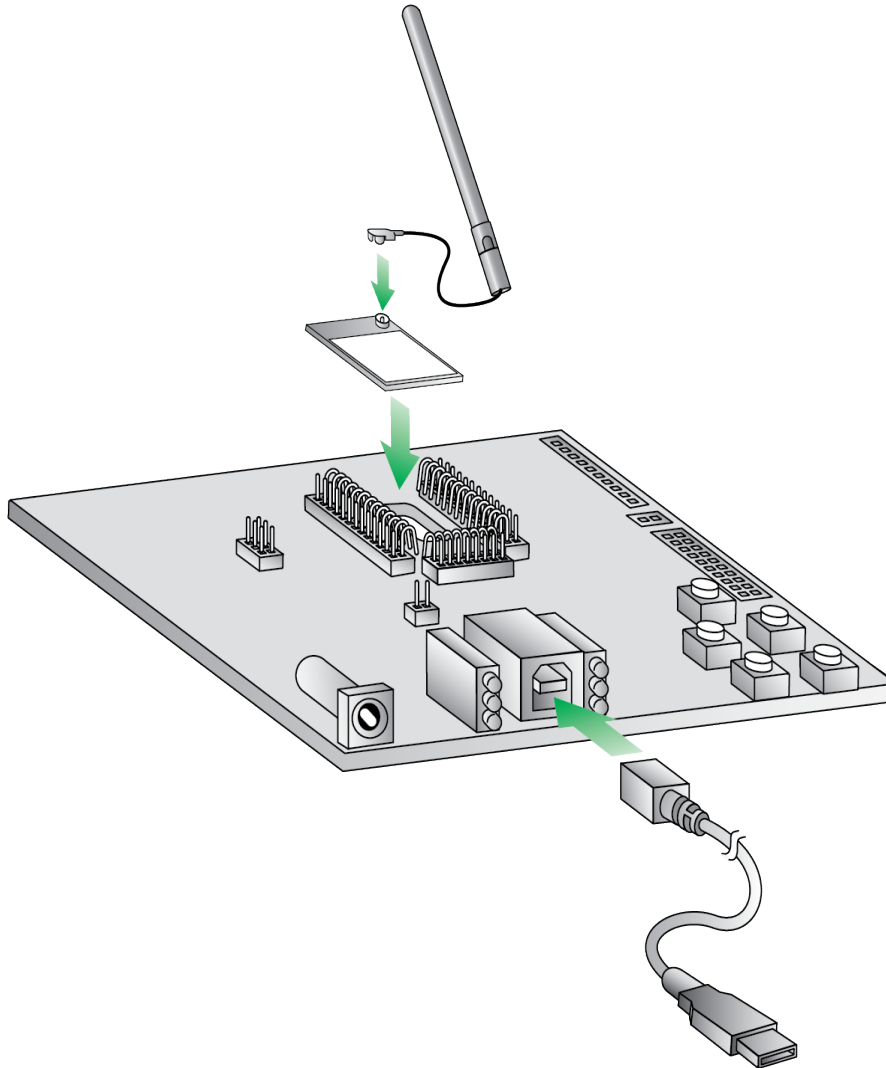

1. Attach the XBee 868LP RF Modules to the development boards.
2. Attach the antennas to the devices.
3. Connect the USB cables to the development boards.



**CAUTION!** Before you remove a device from a development board, make sure the board is not powered by a USB cable or a battery.

## Step 1: Download and install XCTU

This section contains download and install instructions based on operating system. XCTU is compatible with Linux, OSX, and Windows. It may be necessary to configure your system prior to installing XCTU for the first time.

If you get stuck, see [XCTU installation error](#).

### **Download and install XCTU - Windows**

Follow the steps below to download and install XCTU on your computer.

1. Go to [www.digi.com/xctu](http://www.digi.com/xctu).
2. Click **Download**.
3. Under **Download XCTU**, click the Windows installer link.
4. Once the download is complete, run the executable file and follow the steps in the XCTU Setup Wizard.

Once installation is complete, a “What’s new” dialog appears where you can review the new XCTU features.

### **Download and install XCTU - Linux**

By default, access to the serial and USB ports in Linux is restricted to root and dialout group users. To access your XBee devices and use XCTU to communicate with them, it is mandatory that your Linux user belongs to this group. To add your Linux user to the dialout group:

1. Open a terminal console.
2. Execute the following command where <user> is the user you want to add to the dialout group:

---

```
sudo usermod -a -G dialout <user>
```

---

3. Log out and log in again with your user in the system.
4. Go to [www.digi.com/xctu](http://www.digi.com/xctu).
5. Click **Download**.
6. Under **Download XCTU**, click the Linux installer link.
7. Once the download is complete, run the executable file and follow the steps in the XCTU Setup Wizard.

Once installation is complete, a “What’s new” dialog appears where you can review the new XCTU features.

### **Download and install XCTU - OSX**

OSX version 10.8 (Mountain Lion) and greater only allows you to install applications downloaded from the Apple Store. To install XCTU, you must temporarily disable this setting. Follow these steps to enable installation of "unsigned" software:

1. Click the Apple icon in the top-left corner of your screen and choose **System Preferences**.
2. Click the **Security & Privacy** icon.
3. To edit security settings, click the padlock icon in the bottom left of the window.
4. Enter your Mac credentials and click **Unlock**. The **Allow applications downloaded from** dialog appears.
5. Click the **Anywhere** radio button and, in the confirmation window, click **Allow From Anywhere**.

---

**Note** We recommend you set this option back to **Mac App Store** or **Mac App Store and identified developers** once you have finished installing XCTU.

---

6. Go to [www.digi.com/xctu](http://www.digi.com/xctu).
7. Click **Download**.
8. Under **Download XCTU**, click the OSX installer link.
9. Once the download is complete, unzip and run the executable file and follow the steps in the XCTU Setup Wizard.

Once installation is complete, a “What’s new” dialog appears where you can review the new XCTU features.

### ***Optional: Install XCTU updates***

When you start XCTU, you may be notified about software updates. You should always run the latest version of XCTU.

1. When a new version is available, a popup window appears in the bottom-right corner of XCTU.
2. Click on that window and follow the prompts to proceed with the update.

You can also check for updates and manually update the tool by clicking **Help > Check for XCTU Updates**.

### ***Optional: Manually install USB drivers***

When you connect the XBee board to your computer for the first time, drivers are automatically installed. You can also install device drivers manually:

1. Download and install the appropriate USB drivers from the [Digi Support Site](#).
2. Choose your operating system.
3. Download and run the file.
4. Follow the steps in the installation wizard.

## **Step 2: Set up your first wireless connection**

This section shows you how to configure two XBee modules in AT (transparent) mode. The XBee module passes information along exactly as it receives it. All serial data received by the XBee module is sent wirelessly to a remote destination XBee module.

If you get stuck, see [Troubleshooting](#).

### ***Add devices to XCTU***

These instructions show you how to add two devices to XCTU. However, you can use these instructions to add any number of devices.



1. Connect two XBee 868LP RF Modules to your computer using the USB cables.

---

**Tip** Connect the two shorter range XBee modules instead of the longer range XBee-PRO modules. This will make it easier to set up a mesh network. See [Connect the hardware](#).

---

2. Launch XCTU .

3. Click the **Configuration working modes** button .
  4. Click the **Discover radio modules** button .
  5. In the **Discover radio devices** dialog, select the serial ports where you want to look for devices and click **Next**.
  6. In the Set port parameters window, maintain the default values and click **Finish**.
- As XCTU locates devices, they appear in the **Discovering radio modules** dialog box.
7. Click **Add selected devices** once the discovery process has finished.

You should see something like this in the **Radio Modules** section:

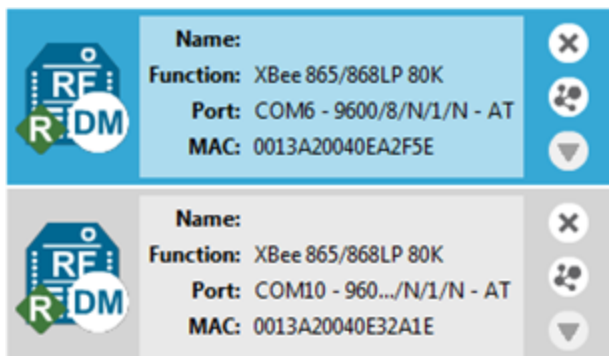

### Configure the first two devices in Transparent mode

To transmit data wirelessly between your XBee devices, configure them to be in the same network.

---

**Tip** To locate a device, select it in XCTU and click the **Read radio settings** button . The Rx and Tx LED lights on its development board blink green and yellow.

---

### Set up the first XBee device (XBEE\_A)

1. Select the first XBee device.

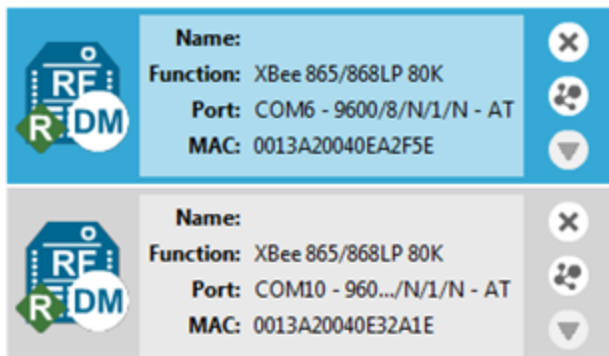

2. Click the **Load default firmware settings** button .

---

**Tip** In the following steps, type parameter letters in the Search box   to quickly find a parameter.

---

3. Configure the following parameters:

**ID:** 2015

**DH:** 0013A200

**DL:** **SL** of XBEE\_B (Enter the last eight characters of the MAC address for XBEE\_B. Or select XBEE\_B and find its **SL** value.)

**NI:** XBEE\_A

4. Click the **Write radio settings** button .

### Set up the second XBee device (XBEE\_B)

1. Configure the following parameters:

**ID:** 2015

**DH:** 0013A200

**DL:** **SL** of XBEE\_A (Enter the last eight characters of the MAC address for XBEE\_A. Or select XBEE\_A and find its **SL** value.)

**NI:** XBEE\_B

2. Click the **Write radio settings** button .

After you write the radio settings for the XBee devices, their names appear in the **Radio Modules** area.

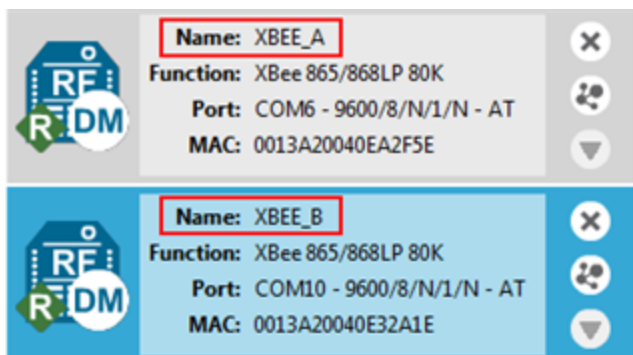

For more information about the parameters, see the following table:

Parameter	XBEE_A	XBEE_B	Effect
<b>ID</b>	2015	2015	Defines the network that a device will attach to. This must be the same for all devices in your network.

Parameter	XBEE_A	XBEE_B	Effect
<b>DH</b>	0013A200	0013A200	Defines the destination address (high part) for the message.
<b>DL</b>	<b>SL</b> of XBEE_B	<b>SL</b> of XBEE_A	Defines the destination address (low part) for the message. The value of this setting is the Serial Number Low ( <b>SL</b> ) of the other XBee device.
<b>NI</b>	XBEE_A	XBEE_B	Defines the node identifier.  <b>Note</b> The default <b>NI</b> value is a blank space. Delete the space when you change the value.

### Check the network

Once both XBee 868LP RF Modules are configured, use XCTU to check that they are in the same network and can see each other.

1. Click the **Discover radio nodes in the same network** button  of XBEE\_A.

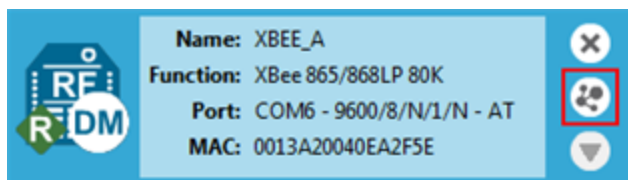

The XBee 868LP RF Module searches for radio modules in the same network.

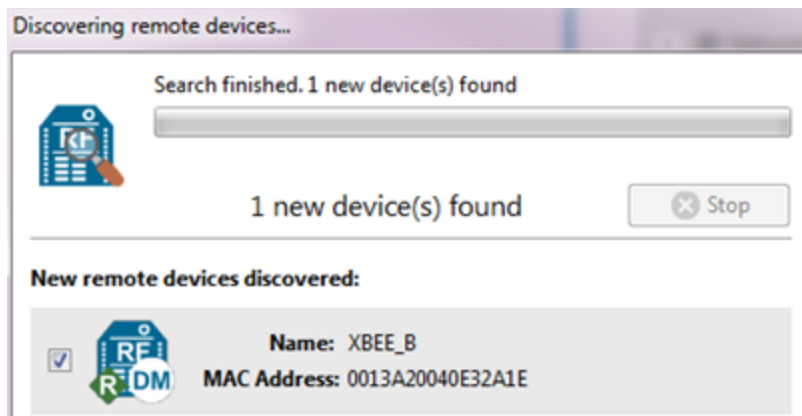





When the discovery process is finished, XCTU lists discovered devices found within the network in the **Discovering remote devices** dialog.

2. Click **Cancel**. There is no need to add the remote device that has been discovered.

### Send messages through XCTU

Use the XCTU console to have the two devices send messages to each other.

1. Switch both XBee 868LP RF Modules to the consoles working mode .
2. Open a serial connection for each XBee.
  - a. Select **XBEE\_A** and click .
  - b. Select **XBEE\_B** and click .
3. Click the **Detach view** button  to see both consoles at the same time.
  - a. In the **Console log** area for XBEE\_A, type "Hello XBEE\_B!"
  - b. In the **Console log** area for XBEE\_B, type "Hello XBEE\_A!"

The message of the sender is in blue font, and the message of the receiver is in red font.

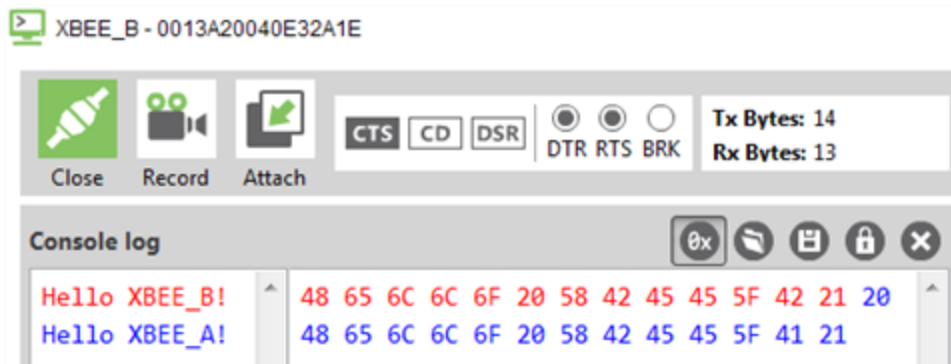
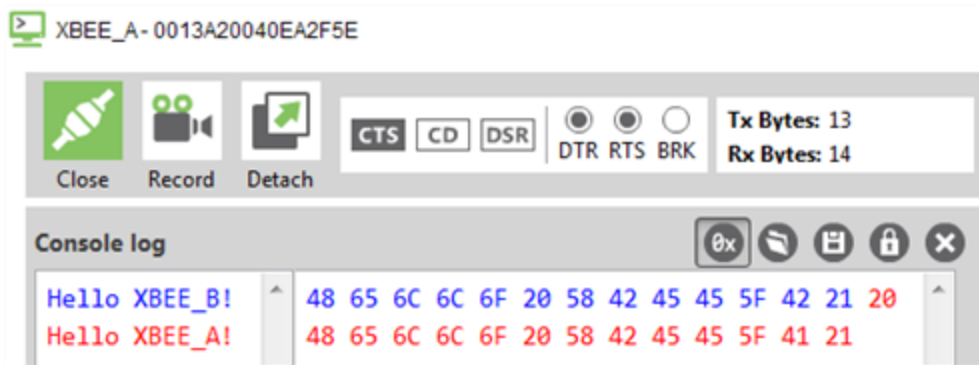

4. Close the window for XBEE\_B.
  5. Keep the serial connections open  for both XBee modules.
- If the two XBee 868LP RF Modules are unable to talk to each other:
- Verify that you accurately configured the parameters. See [Configure the first two devices in Transparent mode](#).
  - Verify that the following parameters are configured appropriately:
    - XBee/XBee-PRO DigiMesh 2.4: The CH (Operating Channel) is the same for both XBee modules.
    - XBee 868LP: The CM (Channel Mask) and HP (Preamble ID) are the same for both XBee modules.

### Step 3: Create a mesh network

This section describes how to add a third XBee module to create a mesh network. Establish a mesh network any time you want to create a network that is larger than the range of each individual radio. In these instructions, you first connect a loopback jumper to an XBee module in preparation for testing your network.

If you get stuck, see [Troubleshooting](#).

#### Connect a loopback jumper to an XBee device

Connecting a loopback jumper to an XBee device lets you send a message to another XBee device and have the message loop back to the sender.

1. Connect the loopback jumper on XBEE\_B so it bridges the two pins on its development board.

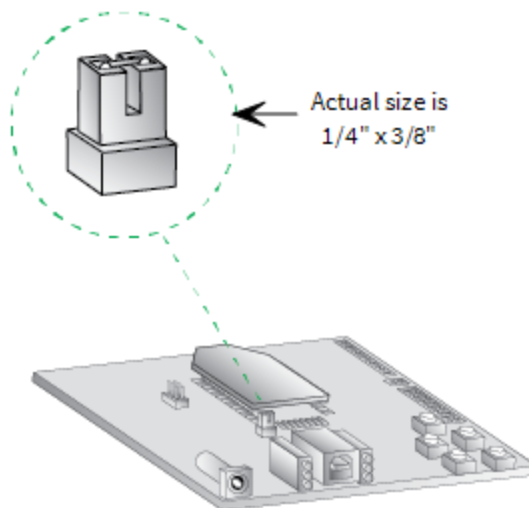

2. In the XBEE\_A console, click the **Clear session** button  to clear your previous conversation.
3. Type **Hello!**

Each character loops back in the XBEE\_A console log, which indicates that XBEE\_A successfully sent the message to XBEE\_B.

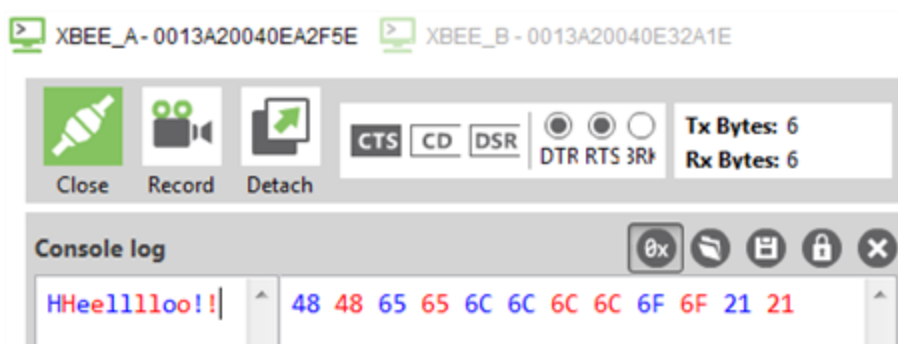

You are now ready to use the loopback jumper to help you test a mesh network consisting of three XBee devices.







### Set up a third XBee module to create a mesh network

To create a mesh network, move XBEE\_B away from XBEE\_A until communication is lost; then add XBEE\_C to relay messages between XBEE\_A and XBEE\_B. The network automatically adjusts and redirects communications as soon as a pathway becomes available.

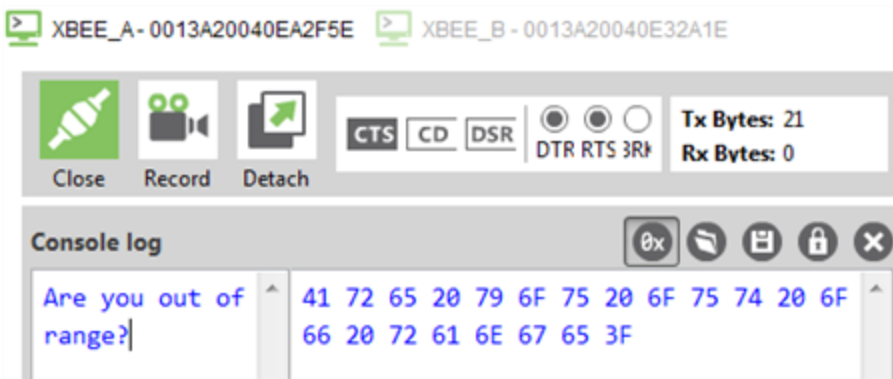
1. Move XBEE\_B out of range of XBEE\_A:
  - a. Disconnect XBEE\_B from your computer and remove it from XCTU.
  - b. Connect XBEE\_B to a power supply (or laptop or portable battery) and move it away from XBEE\_A until it is out of range.

The approximate indoor range is 500 ft (150 m), and the approximate outdoor range is 2.5 miles (4 km).
  - c. Make sure the loopback jumper is connected to XBEE\_B. See [Connect a loopback jumper to an XBee device](#).
  - d. In the XBEE\_A console, click  to clear your previous conversation with XBEE\_B.
  - e. Type "Are you out of range?" In the illustration below, the message does not loop back, which means XBEE\_B did not receive it and it is out of range of XBEE\_A.
  - f. If the message loops back, move XBEE\_B farther away until it no longer loops back.



2. Add and configure another XBee module:
  - a. Connect another XBee module to your computer.
  - b. Click the **Configuration working modes** button .
  - c. Click the **Add a radio module** button .
  - d. In the **Add a radio module** dialog, select the USB Serial Port for this XBee module and click **Finish**.
  - e. Configure this XBee module as follows:  
**ID:** 2015  
**NI:** XBEE\_C
  - f. Click the **Write radio settings** button .

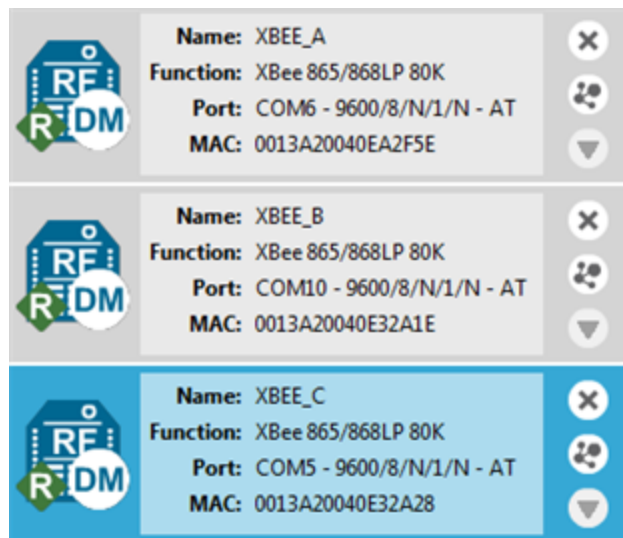

3. Have XBEE\_C relay messages between XBEE\_A and XBEE\_B:
  - a. Switch back to the **Consoles working mode** .
  - b. Disconnect XBEE\_C from your computer and remove it from XCTU.
  - c. Connect XBEE\_C to a power supply (or laptop or portable battery) and place it between XBEE\_A and XBEE\_B.
  - d. Make sure the loopback jumper is still connected to XBEE\_B.
  - e. Have XBEE\_A send a message to XBEE\_B. In the XBEE\_A console, type "Hello!"

In the following illustration, the message loops back. XBEE\_C relayed your message to XBEE\_B, and you successfully established a mesh network.

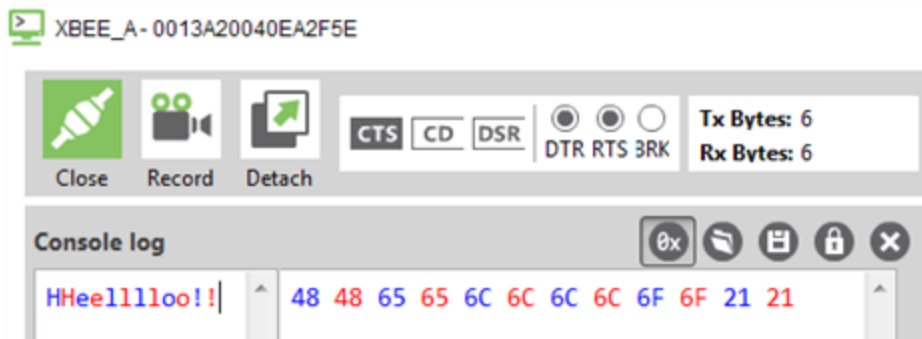

---

**Tip** Use the **Send a single packet** command to send and have an entire message loop back, instead of having individual characters loop back. To do this, click the **Add new packet** button  to compose your message, and then click **Send selected packet** to send your message.

---



Before you perform other tasks, change the loopback jumper on XBEE\_B so it no longer bridges the two pins on its development board. It should look like this:

---

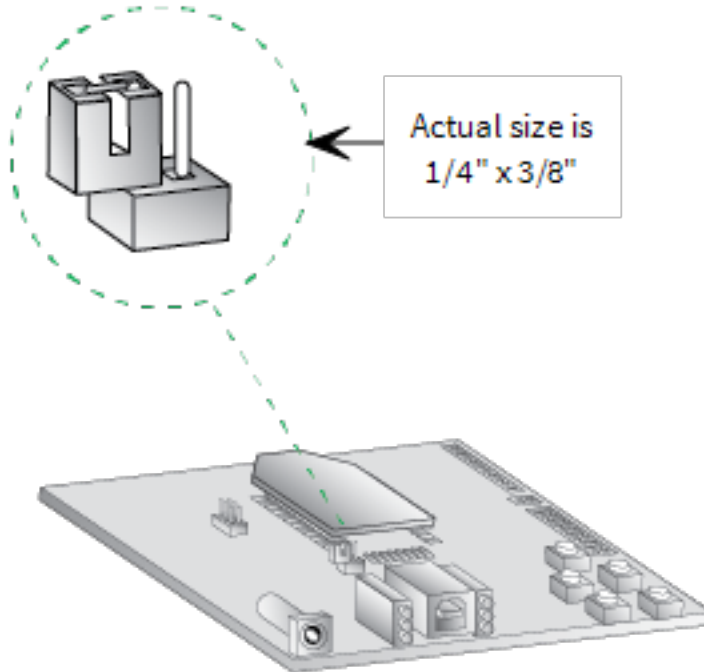

### Step 4: Use API mode to talk to XBee modules

This section shows you how to configure an XBee module in API mode, which gives you flexibility, speed, and reliability in your data transmissions.

If you get stuck, see [Troubleshooting](#).

For more information on API mode, see [Operate in API mode](#).

#### Configure a device in API mode

1. Select XBEE\_A and click the **Configuration working modes** button .
2. Add this configuration:

**AP:** API Mode 1

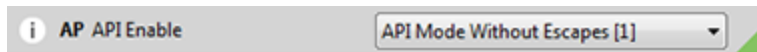

3. Click the **Write radio settings** button .

The Port indicates XBEE\_A is in API mode.

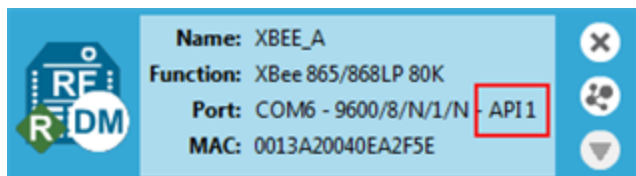

### Send an API Tx frame from an XBee module to another module

API Tx frames are the instructions that allow one XBee module to send data to another XBee module. In these instructions, XBEE\_A uses the API frame type "Transmit Request" to send some text data to XBEE\_B.

1. Reconnect XBEE\_B to your computer.
2. Make sure the loopback jumper on XBEE\_B no longer bridges the two pins on its development board.

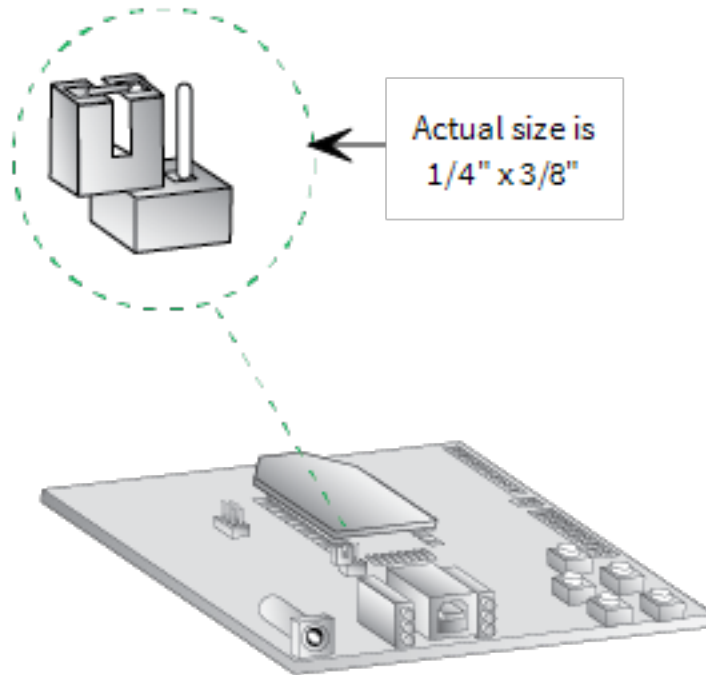

3. In XCTU, rediscover XBEE\_B.
4. Switch XBEE\_A and XBEE\_B to console mode:
  - a. Select **XBEE\_A** and click . Then click to open a serial connection.
  - b. Select **XBEE\_B** and click . Then click to open a serial connection.
5. Select **XBEE\_A**.
6. In the **Send a single frame** area, click the **Add new frame to the list** button .

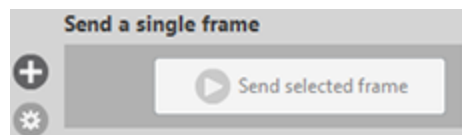

7. In the **Add API frame to the list** dialog, click the **Create frame using 'Frames Generator' tool** button.

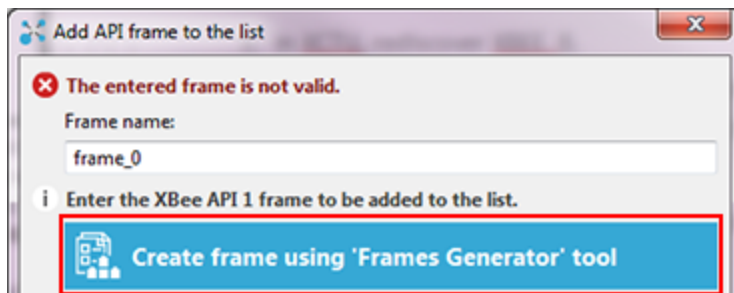

8. In the **XBee API Frame generator** dialog, configure the following parameters:

**Protocol:** DigiMesh

**Mode:** API 1

**Frame type:** 0x10 - Transmit Request

**64-bit dest. address:** MAC address of XBEE\_B

**RF data:** Type "Hello XBee\_B!" in the ASCII tab

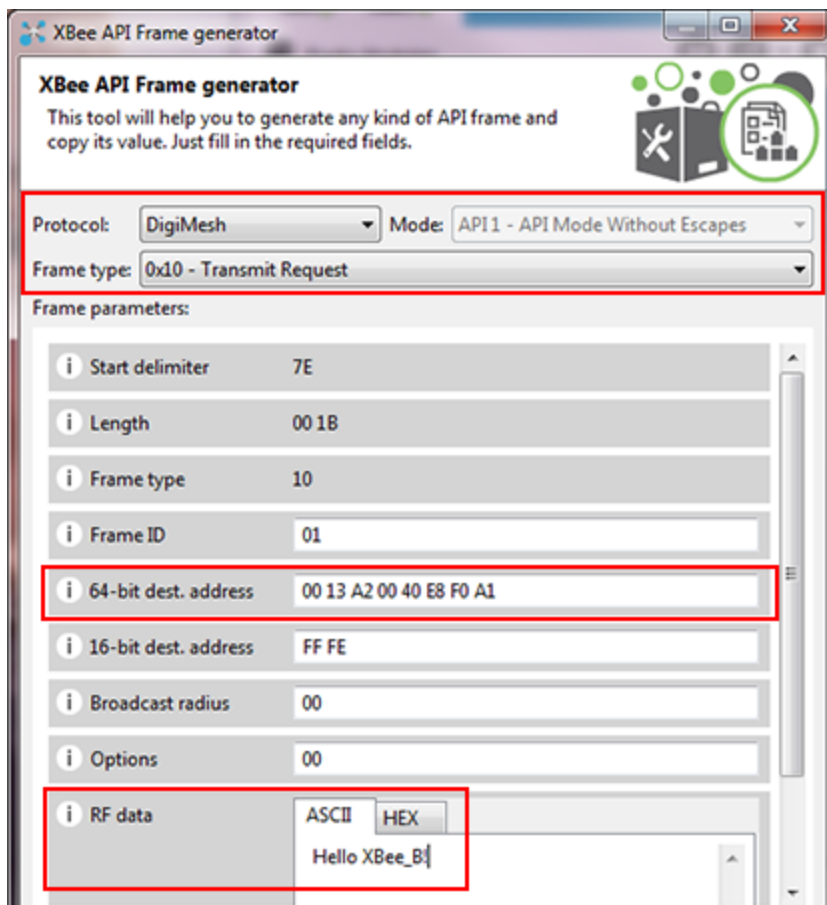

9. Click **OK**.

- 10. In the **Add API frame to the list** dialog, type a name for your frame.
- 11. Click **Add frame**.

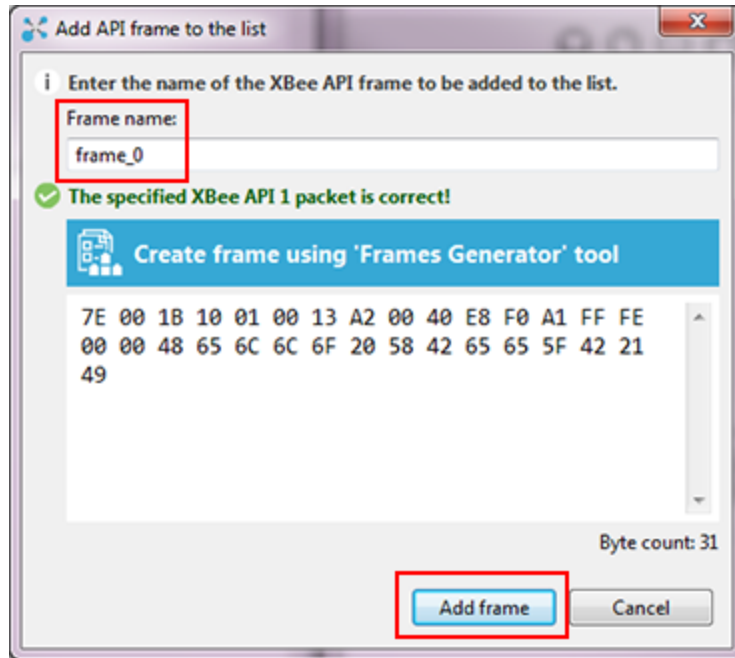

- 12. In the **Send frames** area, make sure your frame is selected.
- 13. In the **Send a single frame** area, click **Send selected frame**.

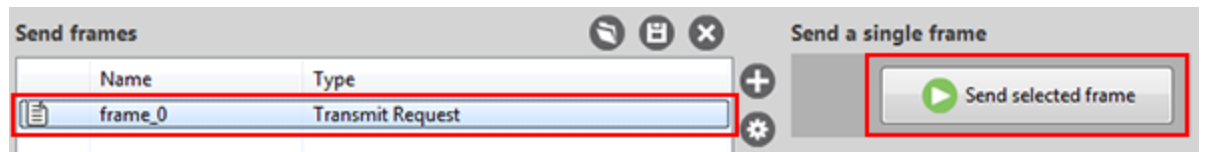

- 14. In the **Frames log** area, select **Transmit Request** and then **Transmit Status** to look at the Frame details for each.

For example, select **Transmit Status** and scroll down in the **Frame details** area to see that your Delivery status is a success.

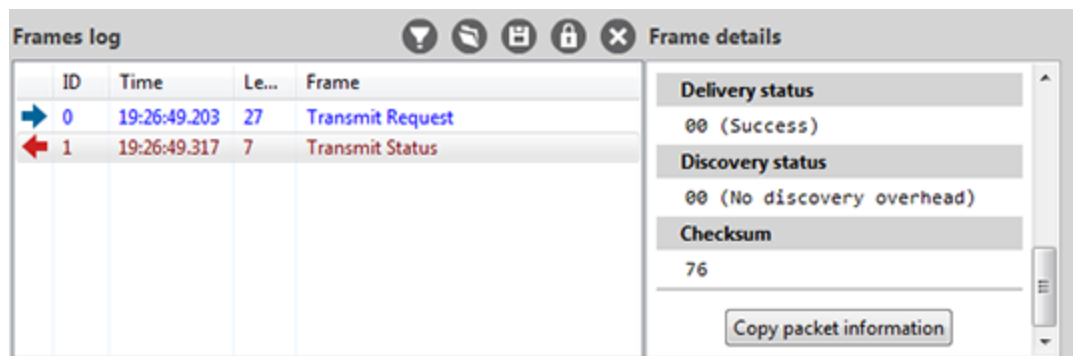

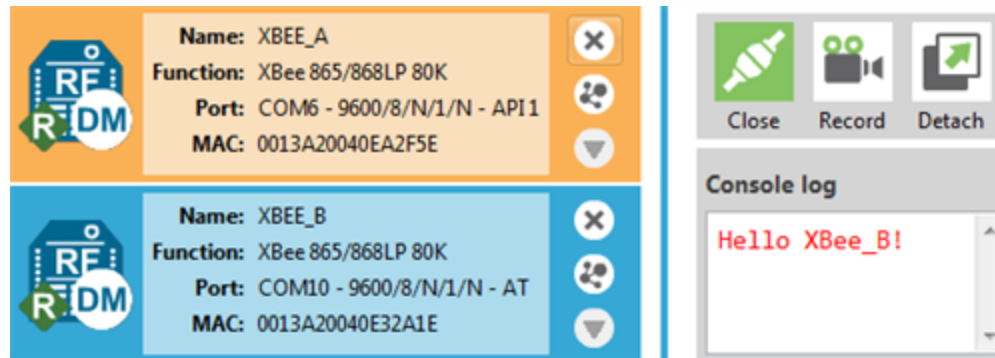

- In the **Radio Modules** area, select **XBEE\_B**. "Hello XBee\_B!" should appear in the Console log.



## Do more with your XBee modules

### Update the firmware

Radio firmware is the program code stored in the radio module's persistent memory that provides the control program for the device. Use XCTU to update the firmware.

- Click the **Configuration working modes** button .
- Add local and remote XBee modules to your computer. See [Add devices to XCTU](#) and [Configure remote devices](#).
- Select a local or remote XBee module from the Radio Modules list.
- Click the **Update firmware** button .

The **Update firmware** dialog displays the available and compatible firmware for the selected XBee module.



5. Select the product family of the XBee module, the function set, and the latest firmware version.

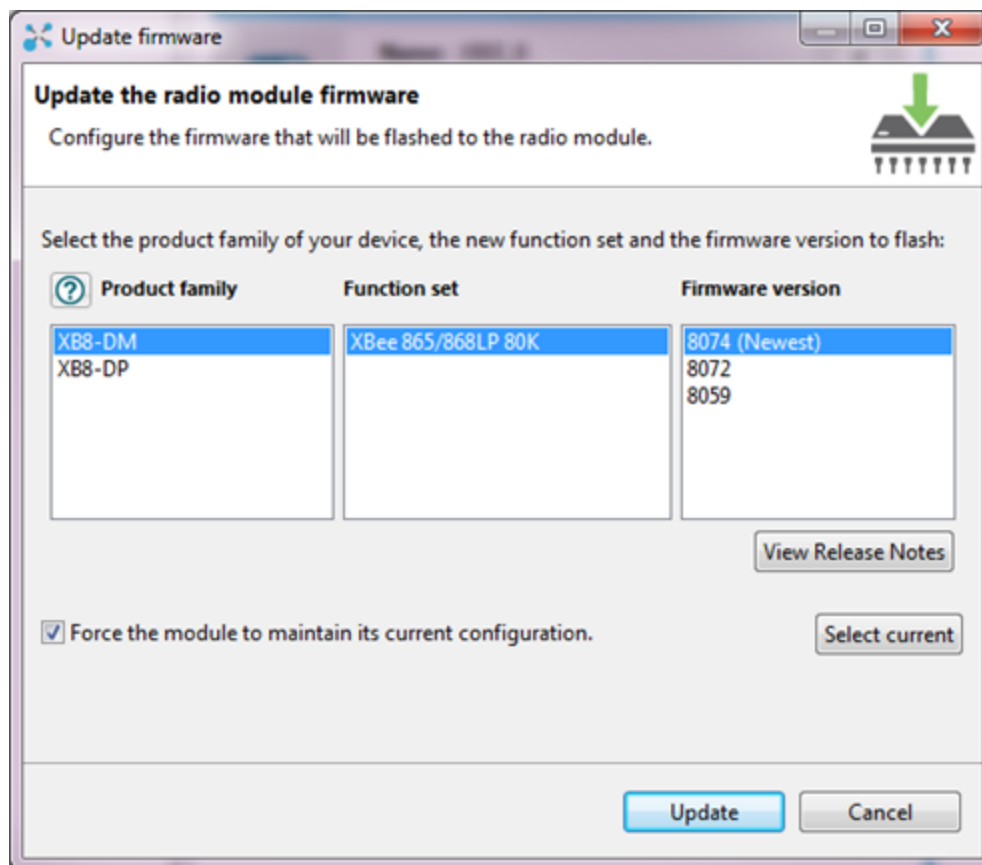

6. Click **Update**. A dialog displays update progress.

## Configure remote devices

You can communicate with remote devices over the air through a corresponding local device. Configure the local device in API mode because remote commands only work in API mode. Configure remote devices in either API or Transparent mode.

These instructions show you how to configure the [LT command](#) parameter on a remote device.

1. Add two XBee devices to XCTU. See [Add devices to XCTU](#).
2. Configure the first device in API mode and name it **XBEE\_A**. See [Configure a device in API mode](#).
3. Configure the second device in either API or Transparent mode, and name it **XBEE\_B**. See [Configure the first two devices in Transparent mode](#).
4. Disconnect XBEE\_B from your computer and remove it from XCTU.

- Connect XBEE\_B to a power supply (or laptop or portable battery).  
The **Radio Modules** area should look something like this.

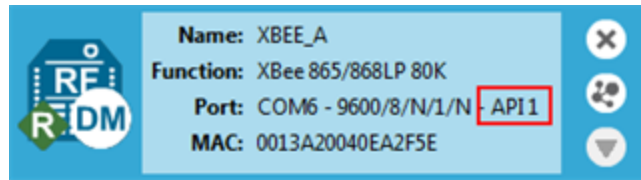

- Select **XBEE\_A** and click the **Discover radio nodes in the same network** button.
- Click **Add selected devices** in the **Discovering remote devices** dialog. The discovered remote device appears below XBEE\_A.

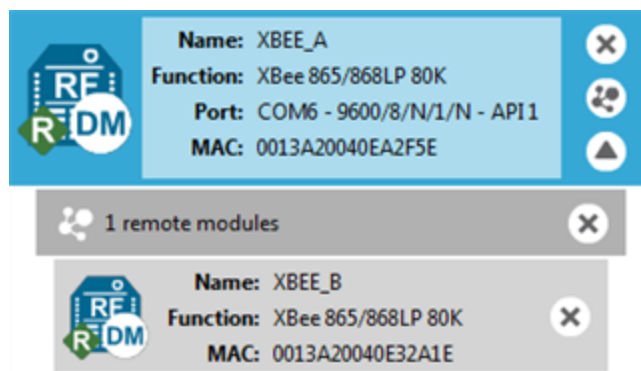

- Select the remote device **XBEE\_B**, and configure the following parameter:  
**LT:** FF (hexidecimal representation for 2550 ms)



- Click the **Write radio settings** button.  
The remote XBee device now has a different LED blink time.
- To return to the default LED blink times, change the **LT** parameter back to 0 for XBEE\_B.

## Set up and perform a range test

This section shows you how to set up two XBee modules to perform a range test, which demonstrates the real-world RF range and link quality between two XBee modules in the same network. Performing a range test gives an initial indication of the expected communication performance of the kit components. When deploying an actual network, perform multiple range tests to analyze varying conditions in your application.

### Configure the devices for a range test

For devices to communicate with each other, you configure them so they are in the same network. You also set the local device to API mode to obtain all possible data of the remote device.

1. Add two devices to XCTU. See [Add devices to XCTU](#).

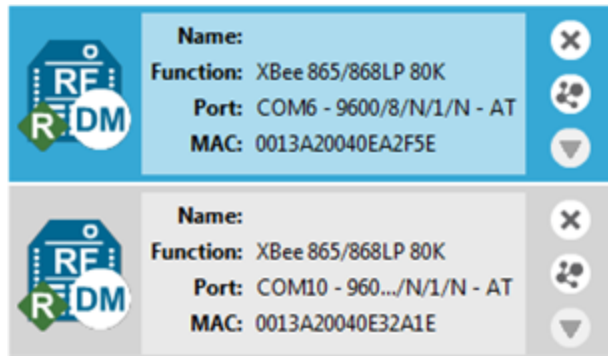

2. Select the first device and click the **Load default firmware settings** button .
3. Configure the following parameters:  
**ID:** 2015  
**NI:** XBEE\_A  
**AP:** API enabled [1]

4. Click the **Write radio settings** button .

5. Select the other device and click .

6. Configure the following parameters:  
**ID:** 2015  
**NI:** XBEE\_B  
**AP:** API disabled [0]

7. Click the **Write radio settings** button .

After you write the radio settings for each device, their names appear in the **Radio Modules** area. The Port indicates XBEE\_A is in API mode.

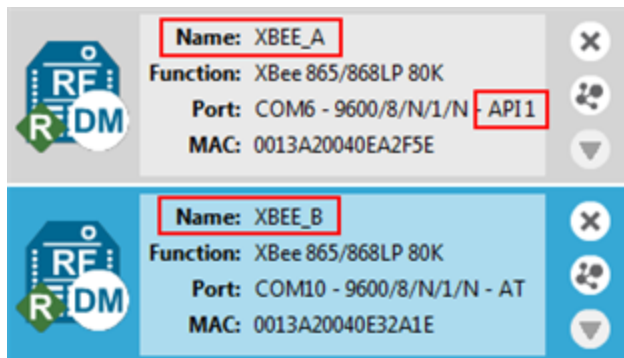

8. Disconnect XBEE\_B from the computer and remove it from XCTU.

9. Connect XBEE\_B to a power supply (or laptop or portable battery) and move it away from XBEE\_A to the desired location for the range test.

The approximate indoor range is 500 ft (150 m), and the approximate outdoor range is 2.5 miles (4 km).

### Perform a range test

These instructions show you how to use the loopback cluster (0x12) when performing a range test. The benefit of using this type of range test is you don't have to close the loopback jumper of the remote module and the module can work in any operating mode.

1. In XCTU, open the **Tools** menu  and select the **Range Test** option.

The **Radio Range Test** window opens. Your local device appears on the left side of the **Device Selection** area.

2. Select **XBEE\_A** and click the **Discover remote devices** button .

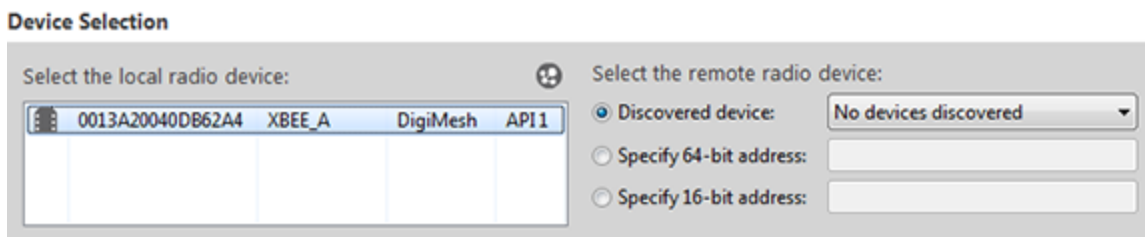

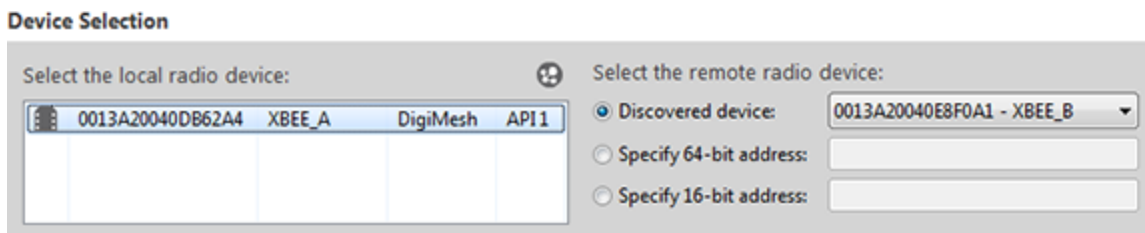

The discovery of remote devices starts. When the discovery process finishes, the other device (XBEE\_B) appears in the Discovering remote devices dialog.

3. Click **Add selected devices**.
4. Select **XBEE\_B** from the **Discovered device** drop-down menu in the **Device Selection** area.

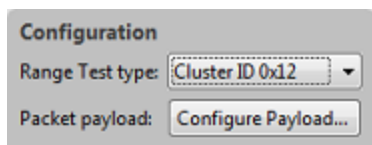

5. For Range Test type, select **Cluster ID 0x12**.



6. Click the **Start Range Test** button .
7. If a notification dialog asks you to close the loopback jumper in the remote device, click **OK**.

- 8. Test the signal interference by doing one of the following:
  - Place your hands over one of the XBee modules.
  - Block line-of-sight with your body.
  - Place a metal box over an XBee module.
  - Move the remote XBee module to a different room or floor of the building.

The Received Signal Strength Indicator (RSSI) value will decrease and some packets may even be lost.

- 9. XCTU represents the retrieved data as follows:
  - **Range Test** charts represent the RSSI values of the local and remote devices during the range test session. The chart also shows the percentage of total packets successfully sent.
  - **Local** and **Remote** bar graphs represent the signal strengths of the local and remote XBee modules. These values are retrieved for the last packet sent/received. RSSI is measured in dBm. A greater negative value in dBm indicates a weaker signal. Therefore, -50 dBm is better than -60 dBm.
  - **Packets sent** and **Packets received** areas show the total number of packets sent, packets received, transmission errors, and packets lost. The percentage bar graph indicates the percentage of packets that are successfully sent and received during a range test session.

In the following illustration, the percentage of packets successfully sent is 69% and received is 64%. The actual percentage of packets successfully sent or received may be higher.

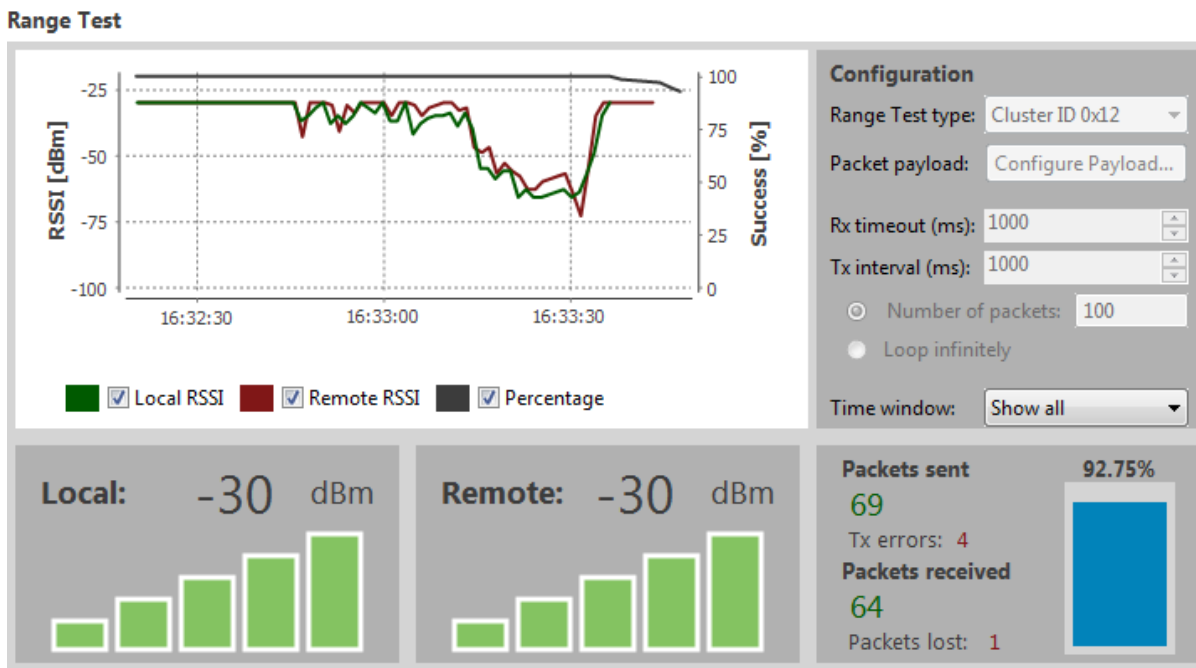

10. Click the **Stop Range Test** button  to stop the process at any time.
11. When you have completed the range test, remove the remote XBee modules from XCTU by clicking the **Remove the list of remote modules** button .

## Configure basic synchronous sleep support

This section shows you how to extend the battery life of an XBee device and demonstrates how a DigiMesh network handles messages when nodes are synchronously sleeping. You will configure one of the devices as a sleep support node and the other two as synchronous cyclic sleep nodes.

The sleep support XBee device is always awake and can receive serial or over-the-air data at any time, whereas the synchronized sleeping devices cannot send or receive data during their sleep periods. When receivers are asleep, the messages are buffered and forwarded to their destination once they have woken up. In either case, XBee devices can only receive data up to the capacity of the input buffer.

### *Configure the sleep coordinator for synchronous sleep support*

These instructions show you how to configure XBEE\_A as the preferred sleep coordinator so it stays awake while the other XBee devices sleep. You then configure XBEE\_B and XBEE\_C so one of them assumes the role of sleep coordinator when you disconnect XBEE\_A. This allows the network to remain in sync with minimal impact on battery life.

---

**Note** If you have only two USB cables: After you configure XBEE\_B, disconnect it from your computer and remove it from XCTU. Then connect it to a power supply (or laptop or portable battery). Next, use the available USB cable to connect and configure XBEE\_C.

---

1. Add three devices to XCTU. See [Add devices to XCTU](#).
2. For each device, click the **Load default firmware settings** button  and then the **Write radio settings** button .

- Configure the three XBee devices in either Transparent or API mode. This example configures the XBee devices in Transparent mode.

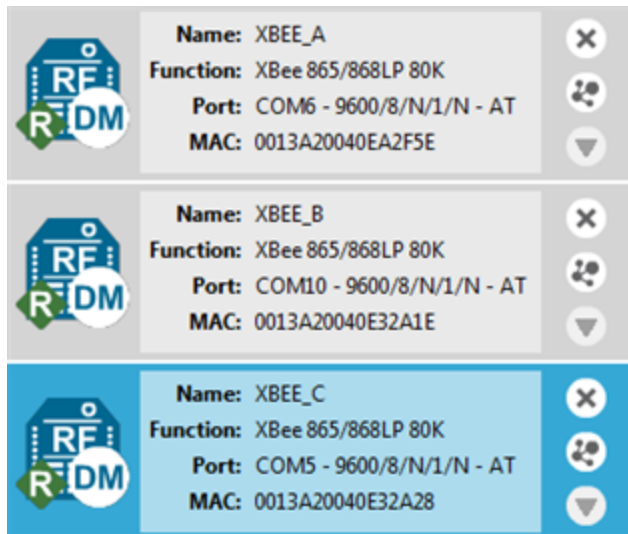

- Select **XBEE\_A** and configure the following parameters:

**SM:** 7  
**SO:** 1 (preferred sleep coordinator)  
**SP:** 1F4 (hexidecimal) = 500 (decimal) x 10 ms = 5 seconds  
**ST:** 1388 (hexidecimal) = 5000 (decimal) x 1ms = 5 seconds

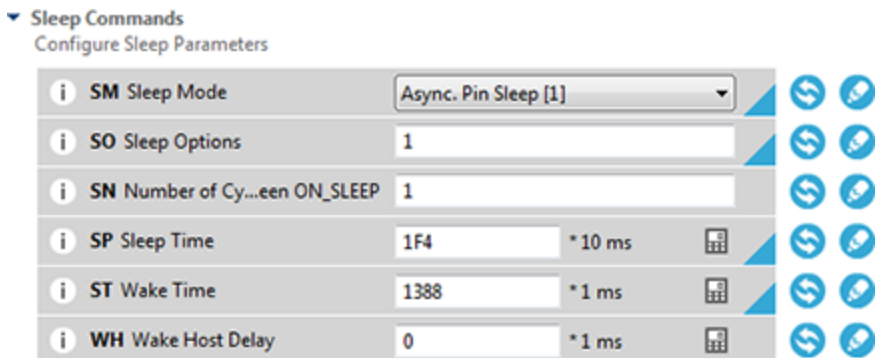

- Click the **Write radio settings** button

---

**Note** The **SP** (sleep time) and **ST** (wake time) are set to five seconds to make it easy to observe synchronous sleep support. To simulate a sensor system such as water monitoring, you might set **SP** to 30 minutes and **ST** to 10 seconds, depending on the number of devices and amount of data that is transferred.

---

6. Select **XBEE\_B** and configure the following sleep parameters:



**SM:** 8

**SO:** 0 (allows the XBee module to take over the role of sleep coordinator if the preferred sleep coordinator fails)

**SP:** 1E (hexidecimal) = 30 (decimal) x 10 ms = 300 ms

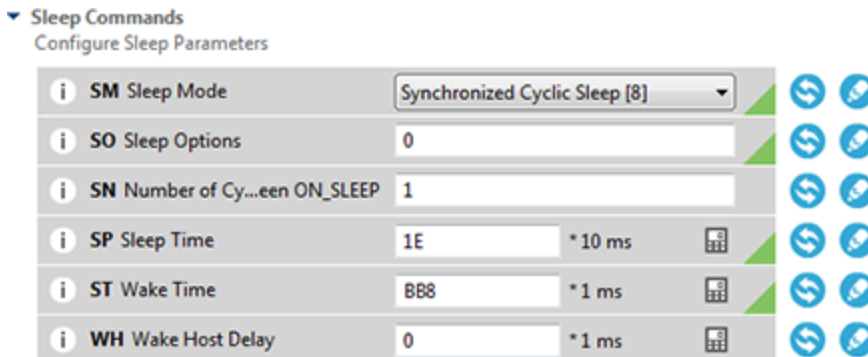
**ST:** BB8 (hexidecimal) = 3000 (decimal) x 1 ms = 3 seconds



7. Click the **Write radio settings** button .
8. Configure the sleep parameters for XBEE\_C as you did for XBEE\_B. Click  when you are done.

---

**Note** Once XBEE\_B and XBEE\_C sync up to the network, their wake and sleep times are controlled by the **OS** and **OW** settings on the sleep support node (XBEE\_A). If you want to change the wake and sleep times, change the **SP** and **ST** values for XBEE\_A.

---

9. The LED lights on the three devices appear as follows:

XBee module	Wake period	Sleep period
XBEE_A (sleep coordinator)	Flashing red light	Solid red light
XBEE_B and XBEE_C	Flashing red light	No light

10. Change the role of sleep coordinator:
  - a. Disconnect XBEE\_A from your computer.
  - b. Observe XBEE\_B or XBEE\_C taking over the role of sleep coordinator by looking at the behavior of the LED lights. It could take three cycles for the new sleep coordinator to take effect.
  - c. Re-connect XBEE\_A to your computer.
  - d. Observe XBEE\_A re-assuming the role of sleep coordinator.







---

**Note** If a device gets out of sync, it goes through a re-synchronization process.

---

### ***Observe flow control during synchronous sleep support***

These instructions demonstrate the importance of observing flow control while XBees are sending and receiving data during synchronous sleep support. Flow control is the process used by a device to inform another device to stop sending data in order to prevent data loss.

1. Click the **Consoles working mode** button .
2. Select **XBEE\_A** (the preferred sleep coordinator), and click  to open a serial connection.
3. Select **XBEE\_B** and click .
4. Click the **Detach view** button  to see both consoles at the same time.

- 5. In the **Console log** area for XBEE\_A, type "Hello XBee\_B! It is Friday! How are you?"

**Note** All XBee DigiMesh modules have a CTS pin (pin 12) that can inform a connected processor when it is permissible to send data to the XBee module. In XCTU, the CTS icon  indicates whether an XBee module is awake (the icon is highlighted) or asleep (the icon is not highlighted).

Since XBEE\_A is the sleep coordinator, it transmits its entire message to XBEE\_B. The CTS icon for XBEE\_A stays on the entire time.

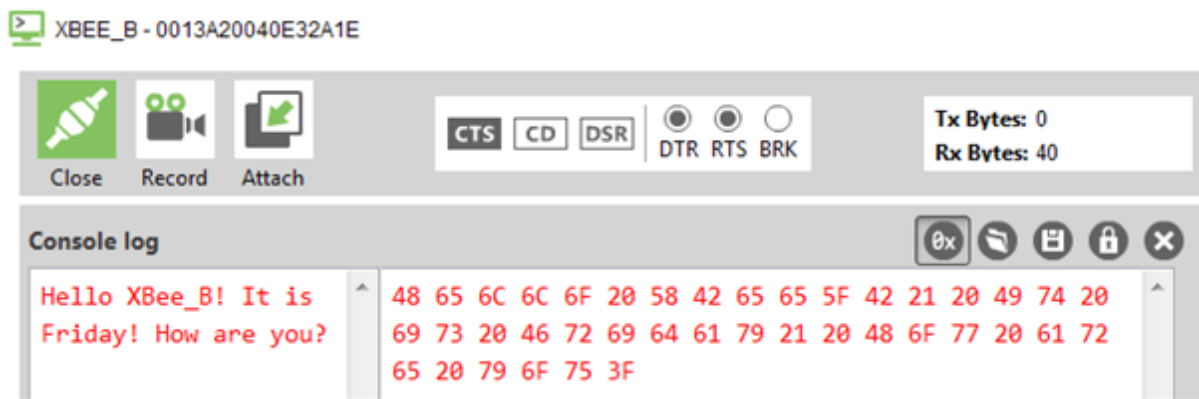
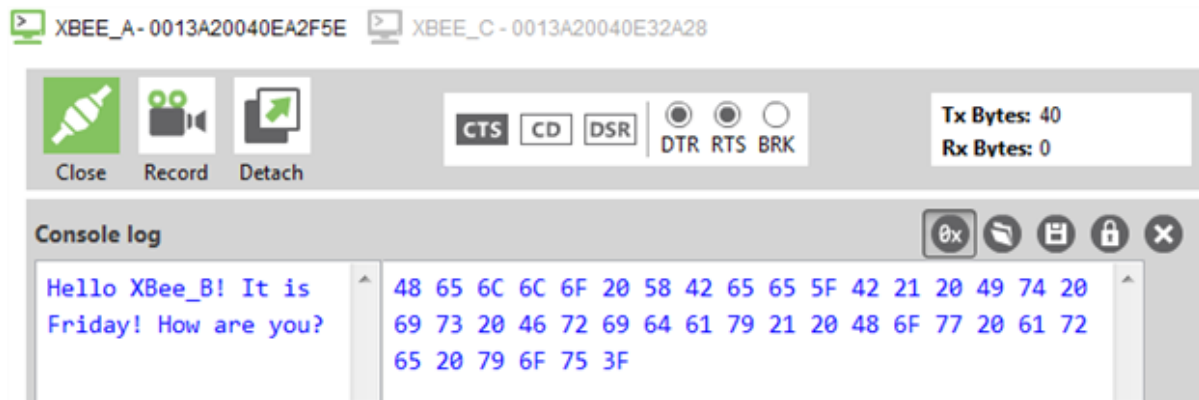

- 6. In the **Console log** area for XBEE\_B, type "Hello XBee\_A! It is Friday! How are you?"  
 Since XBEE\_B is a synchronized sleeping module, it only transmits the part of the message that is typed while it is awake. In the illustration below, it was only able to transmit "Hello XBee\_A!" The CTS icon for XBEE\_B turned off after this part of the message was typed.

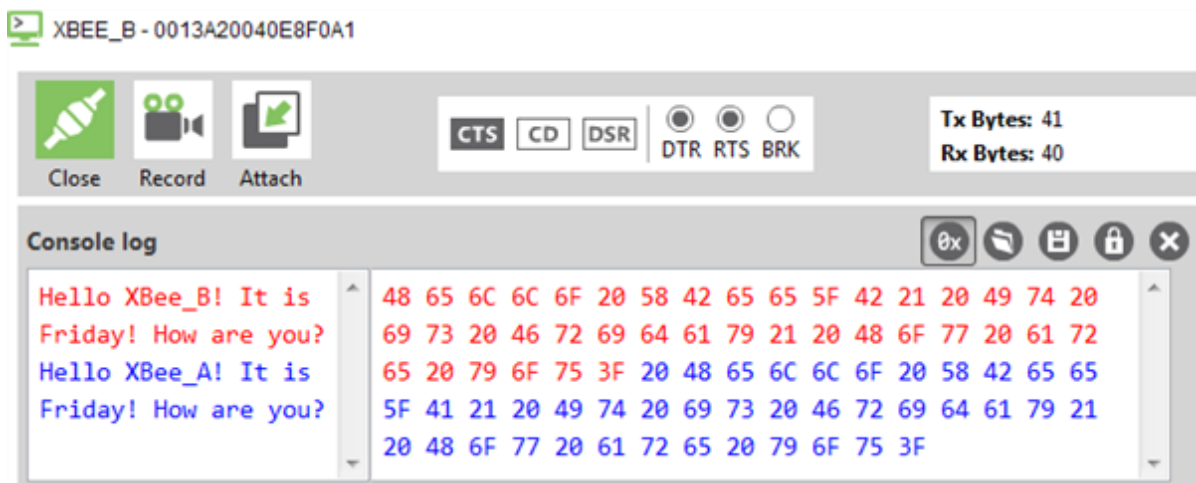
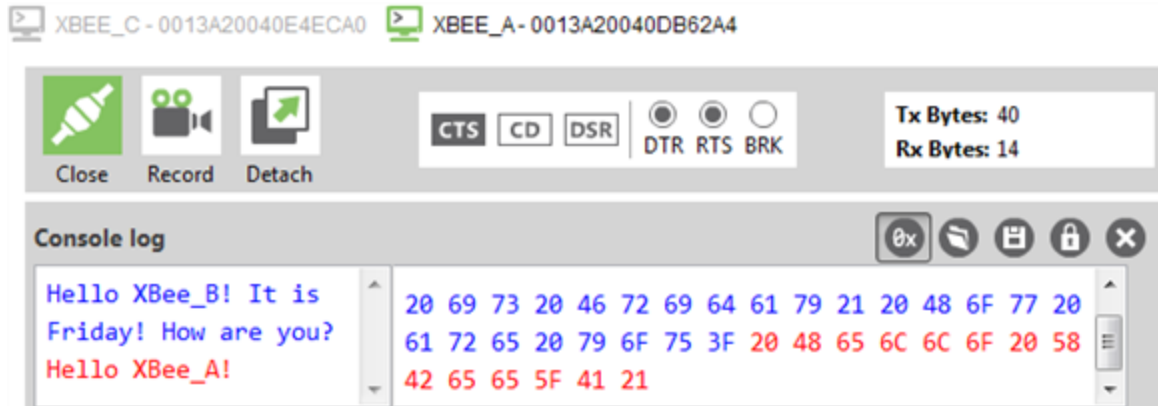

- 7. To disconnect, click the **Close serial connection** button  for each console.

### Set up basic encryption for an XBee network

The information transmitted in an XBee network sometimes needs to be protected. For example, an XBee network transferring financial information must be carefully protected against external agents. These instructions show you how to configure XBee 868LP RF Modules for secure communication via encryption keys.

---

**Note** You can use encryption for devices that have been configured for either Transparent or API mode.

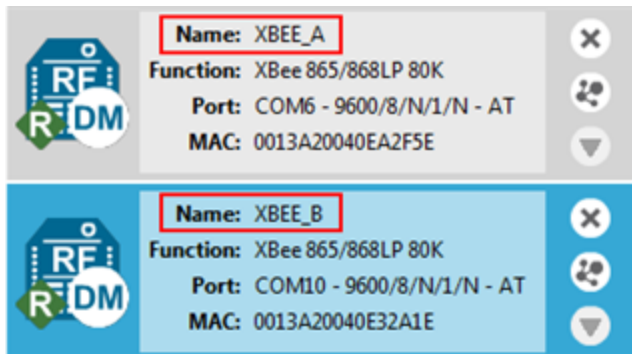

---

1. Add two XBee modules to XCTU. See [Add devices to XCTU](#).
2. Configure the XBee modules so they can talk to each other. See [Configure the first two devices in Transparent mode](#).
3. Name your two XBee modules **XBee\_A** and **XBee\_B**.



4. Select **XBee\_A** and configure the following parameters:  
**EE:** Set the **AES Encryption Enable** parameter to 1.  
**KY:** Set the **AES Encryption Key** parameter to a 32 hexadecimal character string. Example: 1111122222333334444455555666677



5. Click the **Write radio settings** button .
6. Configure the parameters for XBEE\_B as you did for XBEE\_A, and then click .
7. Send a secure message between XBee\_A and XBee\_B. See [Send messages through XCTU](#).

---

**Note** If you add more devices, give them the same encryption key so they can communicate with the other XBee devices.

---

8. To return to the encryption disabled setting, change the **EE** parameter back to **0** for XBEE\_A and XBEE\_B.

## Learn more about XBee module features

For more information about XBee 868LP RF modules, see the *XBee 868LP RF Modules User Guide*. You can find this guide on the [Digi Support site](#).

### Unicast versus broadcast transmissions

An XBee module can communicate with multiple devices or with just one device:

- Broadcast transmissions are sent to many or all XBee modules in the network.
- Unicast transmissions route wireless data from one XBee module to another specific XBee module.

### ***Broadcast transmission***

A broadcast transmission transmits the same data to all nodes on the network. These transmissions are propagated throughout the entire network so that all possible nodes receive the transmission.

An example of broadcast communication is a television station.

### ***Unicast transmission***

A unicast transmission sends messages to a single node on the network that is identified by a unique 64-bit address. The destination XBee module could be an immediate neighbor of the sender, or be several hops away.

An example of a unicast communication is a telephone call between two people.

For more information, see [Data transmission and routing](#).

## **Analog inputs and digital inputs and outputs**

All XBee modules have a set of pins that can be used to connect sensors or actuators and configure them for specific behavior. Each XBee module has the capability to directly gather sensor data and transmit it without the use of an external microcontroller.

With these pins you can, for example, turn on a light by sending information to an XBee module connected to an actuator, or measure the outside temperature by obtaining data from a temperature sensor attached to your XBee module.

## **Sleep modes**

Putting XBee devices into a temporary sleep state preserves battery life when using wireless networks. DigiMesh devices support five sleep modes that are classified as synchronous or asynchronous. For more information about using sleep modes, see [Sleep modes](#).

---

**Note** Asynchronous sleep modes should not be used in a synchronous sleeping network, and vice versa.

---

## **Transparent and API operating modes**

The firmware operates in several different modes. Two top-level modes establish how the device communicates with other devices through its serial interface: Transparent operating mode and API operating mode.

### ***Transparent operating mode***

Devices operate in this mode by default. We also call this mode “AT operating mode.” The device acts as a serial line replacement when it is in Transparent operating mode. The device queues all of UART data it receives through the DIN pin for RF transmission. When a device receives RF data, it sends the data out through the DOUT pin. You can set the configuration parameters using the AT Command interface.

### **API operating mode**

API operating mode is an alternative to Transparent mode. API mode is a frame-based protocol that allows you to direct data on a packet basis. It can be particularly useful in large networks where you need to control the route a data packet takes or when you need to know which node a data packet is from. The device communicates UART data in packets, also known as API frames. This mode allows for structured communications with serial devices. It is helpful in managing larger networks and is more appropriate for performing tasks such as collecting data from multiple locations or controlling multiple devices remotely.

There are two types of API operating modes: one with escaped characters and another without escaped characters.

- Without escaped characters. This mode eliminates escaping character sequences. This makes it simpler to create code and libraries, but runs a minor risk of lost frames or errors due to the possibility that payload data can be confused with frame structure. We do not recommend this mode for noisy radio environments and where payload data may include special characters (specifically 0x7E, 0x7D, 0x11, and 0x13).
- With escaped characters. This mode escapes characters in an API frame in order to improve the reliability of the RF transmission, especially in noisy environments. API escaped operating mode (AP = 2) works similarly to API mode. The only difference is that when working in API escaped mode, the software must escape any payload bytes that match API frame specific data, such as the start-of-frame byte (0x7E).

## **Troubleshooting**

If you get stuck while performing any of the tasks in this guide, try one of these troubleshooting tips.

### **Cannot install device driver**

Device driver software was not successfully installed.

#### **Condition**

Sometimes when you connect an XBee module to your computer, the operating system does not install the driver.

#### **Solution**

Try the following, in order. If one of the steps resolves the issue, you're done.

1. Remove and re-insert the XBee module into your computer.
2. If the OS is still unable to install the driver, remove and re-insert the XBee module into another USB port.
3. Manually install the USB drivers. See [Optional: Manually install USB drivers](#).

### **Use LEDs to identify XBee modules**

You want to force LEDs to blink so you can easily locate an XBee 868LP RF Module.

### Resolution

To locate an XBee 868LP RF Module using LEDs:

1. In XCTU, select one of the devices and click the **Read radio settings** button .
2. Observe which device has the Rx and Tx LED lights blinking green and yellow on its development board.

### No remote devices to select for a range test

If there are no remote devices to select in the Radio Range Test dialog, try one of the following resolutions.

#### Check cables

The USB cables should be firmly and fully attached to both the computer and the development board. When attached correctly, the association LED on the adapter is illuminated.

#### Check that the device is fully seated in the development board

When the device is correctly installed, it is pushed fully into the board and no air or metal is visible between the plastic of the adapter socket and the XBee 868LP RF Module headers. Also, check that all ten pins on each side of the device are in a matching hole in the socket.

#### Check the XBee device orientation

The angled "nose" of the XBee 868LP RF Module should match the lines on the silk screening of the board and point away from the USB socket on the development board.

#### Check that the devices are in the same network

Check that the following parameters have the same value for all devices on the network:

XBee module development kit	Parameters
XBee/XBee-PRO DigiMesh 2.4	<b>ID</b> (Network ID) and <b>CH</b> (Operating Channel)
XBee S2C DigiMesh 2.4	<b>ID</b> (Network ID) and <b>CH</b> (Operating Channel)
XBee 868LP	<b>ID</b> (Network ID), <b>HP</b> (Preamble ID), and <b>CM</b> (Channel Mask)

#### Restore default settings

If the devices are properly connected and in the same network, restore default settings and configure them again.



#### Port in use

Message: "The port is already in use by other applications."

**Condition**

The serial port where the local XBee 868LP RF Module is connected can only be in use by one application.

**Solution**

Make sure the connection with the XBee 868LP RF Module in the XCTU console is closed and there are no other applications using the port.

**XCTU cannot discover devices**

If XCTU does not discover an XBee device or does not display any serial ports, try the following resolutions.

**Check the configuration of your USB serial converter**

1. On the **Start** menu, click **Computer > System Properties > Device Manager**.
2. Under Serial Bus controllers, double-click the first USB Serial Converter to open the USB Serial Converter dialog.
3. Click the **Advanced** tab, make sure **Load VCP** is selected, and click **OK**.
4. Repeat steps 2 and 3 for each USB Serial Converter listed in the Device Manager.

**Check cables**

Double-check all cables. The USB cable should be firmly and fully attached to both the computer and the XBee development board. When attached correctly, the association LED on the adapter will be lit.

**Check that the XBee module is fully seated in the XBee development board**

When the XBee module is correctly installed, it should be pushed fully into the board and no air or metal should be visible between the plastic of the adapter socket and the XBee module headers. Also, double-check that all ten pins on each side of the XBee module made it into a matching hole in the socket.

**Check the XBee module orientation**

The angled "nose" of the XBee module should match the lines on the silk screening of the board and point away from the USB socket on the XBee development board.

**Check driver installation**

Drivers are installed the first time the XBee development board is plugged in. If this process is not complete or has failed, try the following steps:

1. Remove and re-insert the board into your computer. This may cause driver installation to re-occur.
2. Remove and re-insert the board into another USB port.
3. (Windows) Open Computer management, find the failing device in the Device Manager section and remove it.
4. Download the appropriate driver. You can download drivers for all major operating systems from FTDI for manual installation.



### Check if the modules are sleeping

The On/Sleep LED of the XBee development board indicates if the XBee module is awake (LED on) or asleep (LED off). When an XBee module is sleeping, XCTU cannot discover it, so press the Commissioning button to wake it up for 30 seconds.

### XCTU cannot discover remote devices

XCTU does not discover remote XBee 868LP RF Module.

#### Potential cause

The devices do not have the appropriate values for the following parameters:

XBee module development kit	Parameters
XBee 868LP	<b>ID</b> (Network ID), <b>HP</b> (Preamble ID), and <b>CM</b> (Channel Mask)

#### Resolution

1. Ensure that all devices on your network have the same value for each of the parameters listed in the table.
2. If this does not resolve the issue, try setting your devices back to their default settings. Select each XBee device and click the **Load default firmware settings** button .

### XCTU cannot discover remote devices for a range test

When setting up a range test in the Radio Range Test dialog, you receive the message "There are not remote devices discovered for the selected local device."

#### Condition

In the Radio Range Test dialog, the local radio device you selected has not yet discovered any remote devices.

#### Solution

In the Device Selection area in the Radio Range Test dialog, click the **Discover remote devices** button  and XCTU will discover devices on the local device's network.

### XCTU installation error

An error is reported when installing XCTU.

#### Condition

XCTU requires Administrator permissions.

**Solution**

Check that you have Administrator access on the computer where you are installing XCTU. On Windows systems, a User Account Control dialog may appear when you install XCTU or try to run the XCTU program. You must answer yes when prompted to allow the program to make changes to your computer, or XCTU will not work correctly. Note that you may also need to talk to your network manager to gain permission to install or run applications as administrator.

## Configure the XBee 868LP RF Module

---

Software libraries .....	68
XBee Network Assistant .....	68

## Software libraries

One way to communicate with the XBee 868LP RF Module is by using a software library. The libraries available for use with the XBee 868LP RF Module include:

- [XBee Java library](#)
- [XBee Python library](#)

The XBee Java Library is a Java API. The package includes the XBee library, its source code and a collection of samples that help you develop Java applications to communicate with your XBee devices.

The XBee Python Library is a Python API that dramatically reduces the time to market of XBee projects developed in Python and facilitates the development of these types of applications, making it an easy process.

## XBee Network Assistant

The XBee Network Assistant is an application designed to inspect and manage RF networks created by Digi XBee devices. Features include:

- Join and inspect any nearby XBee network to get detailed information about all the nodes it contains.
- Update the configuration of all the nodes of the network, specific groups, or single devices based on configuration profiles.
- Geo-locate your network devices or place them in custom maps and get information about the connections between them.
- Export the network you are inspecting and import it later to continue working or work offline.
- Use automatic application updates to keep you up to date with the latest version of the tool.

See the [XBee Network Assistant User Guide](#) for more information.

To install the XBee Network Assistant:

1. Navigate to [digi.com/xbeenetworkassistant](http://digi.com/xbeenetworkassistant).
2. Click **General Diagnostics, Utilities and MIBs**.
3. Click the **XBee Network Assistant - Windows x86** link.
4. When the file finishes downloading, run the executable file and follow the steps in the XBee Network Assistant Setup Wizard.

## Operation

---

Operation .....	70
Listen Before Talk and Automatic Frequency Agility .....	70
Single frequency mode band mode .....	71
Serial communications .....	71
Configuration considerations .....	75
Serial buffers .....	76
UART flow control .....	76
Force UART operation .....	77
Serial interface protocols .....	77

## Operation

The XBee 868LP RF Module uses a multi-layered firmware base to order the flow of data, dependent on the hardware and software configuration you choose. The following configuration block diagram shows the host serial interface as the physical starting point and the antenna as the physical endpoint for the transferred data. A block must be able to touch another block above or below it for the two interfaces to interact. For example, if the device uses SPI mode, Transparent mode is not available as shown in the following image:

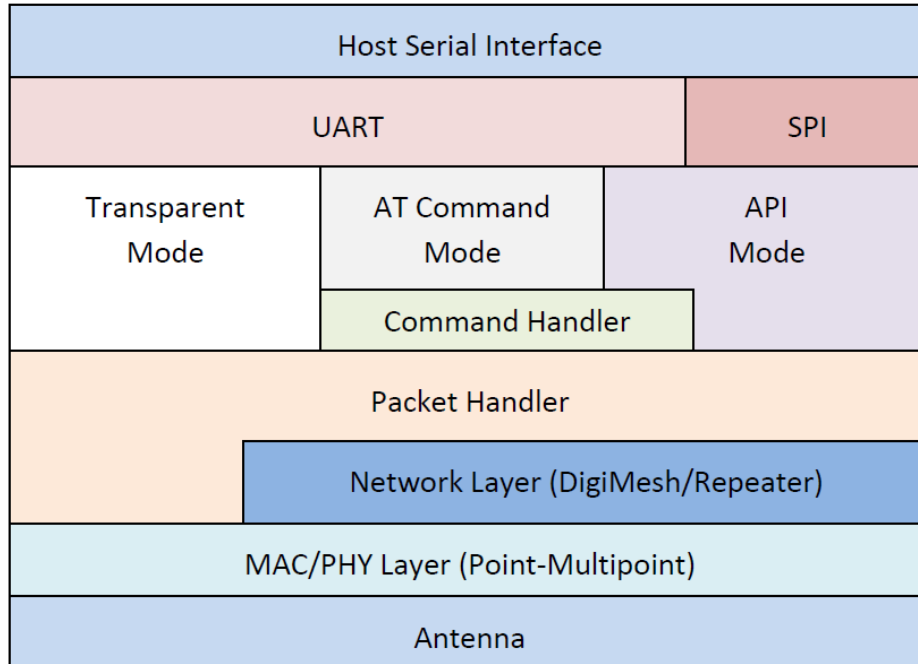

The command handler code processes commands from AT Command Mode or API Mode; see [AT commands](#). The command handler also processes commands from remote devices; see [API frame exchanges](#).

## Listen Before Talk and Automatic Frequency Agility

This device implements Listen Before Talk (LBT) and Automatic Frequency Agility (AFA). The advantage of LBT with AFA is that the device bypasses the Duty Cycle requirement imposed by European standards. LBT+AFA requires that you use at least two frequencies for transmission.

This feature provides a level of fairness to the devices in a given area. Before this device transmits, it senses a channel to determine if there is activity by taking an RSSI measurement for 5 ms. If the measurement is below the threshold, the device transmits on that channel. If there is activity, that channel is not used, and the device listens for at least 5 ms to allow transmissions to be received.

After the device transmits on a channel, it will not transmit on that channel again until the minimum TX off time has been met, which is greater than 100 ms. It is useful to have many channels in your channel mask, so transmissions are less likely to be delayed.

European requirements also state that only 100 seconds of transmission may occur over the period of an hour on 200 kHz of spectrum. This method simplifies and optimizes the calculations of spectrum use over the period of one hour. The standard states that the more channels you have, the more transmission time you have in a one hour period. Calculate the effective duty cycle based on the number of available channels enabled as follows:

Effective Duty Cycle = (number of channels \* 100)/3600.

For example, if you enabled two channels you would have an effective duty cycle of 5.6%.

The XBee 868LP RF Module uses a sliding bucket algorithm to calculate usage over the period of 1 hour for each channel. Each bucket accumulates for 6 minutes.

This device has a maximum of 30 AFA channels to choose from, and channels can be excluded by setting the channel mask (**CM**) to reduce them. Since not all countries allow for all of these channels, the set may be dramatically smaller for some countries. For a complete list, refer to [www.digi.com](http://www.digi.com).

## Single frequency mode band mode

When you set the channel mask to 0x20000000, the device is in a single frequency mode, and the frequency is 869.85 MHz. In this mode:

- LBT+AFA mode is disabled.
- The device assumes no duty cycle requirement (or 100% duty cycle).
- The **PL** setting must be set to 5 mW to comply with the single frequency mode requirements.

## Serial communications

RF Modules interface to a host device through a serial port. Using its serial port, the device communicates with any of the following:

- Logic and voltage compatible UART
- Level translator to any serial device (for example, through an RS-232 or USB interface board)

### UART data flow

Devices that have a UART interface connect directly to the pins of the XBee 868LP RF Module as shown in the following figure. The figure shows system data flow in a UART-interfaced environment. Low-asserted signals have a horizontal line over the signal name.



### Serial data

A device sends data to the XBee 868LP RF Module's UART through pin 4 DIN as an asynchronous serial signal. When the device is not transmitting data, the signals should idle high.

For serial communication to occur, you must configure the UART of both devices (the microcontroller and the XBee 868LP RF Module) with compatible settings for the baud rate, parity, start bits, stop bits, and data bits.

Each data byte consists of a start bit (low), 8 data bits (least significant bit first) and a stop bit (high). The following diagram illustrates the serial bit pattern of data passing through the device. The diagram shows UART data packet 0x1F (decimal number 31) as transmitted through the device.

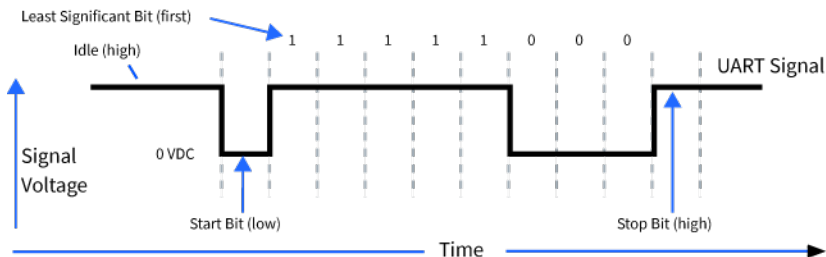

You can configure the UART baud rate, parity, and stop bits settings on the device with the **BD**, **NB**, and **SB** commands respectively. For more information, see [Serial interfacing commands](#).

### SPI communications

The XBee 868LP RF Module supports SPI communications in slave mode. Slave mode receives the clock signal and data from the master and returns data to the master. The following table shows the signals that the SPI port uses on the device.

Signal	Function
SPI_MOSI (Master Out, Slave In)	Inputs serial data from the master
SPI_MISO (Master In, Slave Out)	Outputs serial data to the master
SPI_SCLK (Serial Clock)	Clocks data transfers on MOSI and MISO
SPI_SSEL (Slave Select)	Enables serial communication with the slave
SPI_ATTN (Attention)	Alerts the master that slave has data queued to send. The XBee 868LP RF Module asserts this pin as soon as data is available to send to the SPI master and it remains asserted until the SPI master has clocked out all available data.

In this mode:

- SPI clock rates up to 3.5 MHz are possible.
- Data is most significant bit (MSB) first.
- Frame Format mode 0 is used. This means CPOL= 0 (idle clock is low) and CPHA = 0 (data is sampled on the clock's leading edge).
- The SPI port only supports API Mode (**AP = 1**).

The following diagram shows the frame format mode 0 for SPI communications.



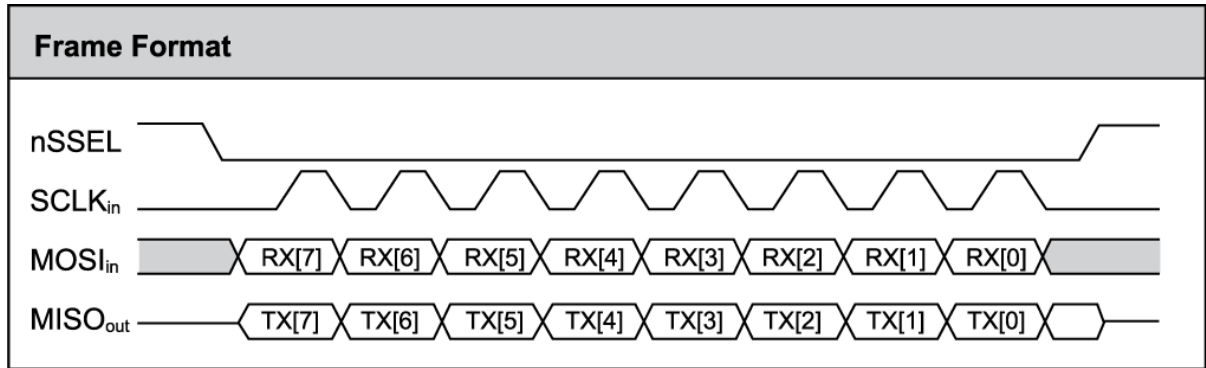

### SPI operation

This section specifies how SPI is implemented on the device, what the SPI signals are, and how full duplex operations work.

#### SPI implementation

The XBee 868LP RF Module operates as a SPI slave only. This means an external master provides the clock and decides when to send data. The XBee 868LP RF Module supports an external clock rate of up to 3.5 Mb/s.

The device transmits and receives data with the most significant bit first using SPI mode 0. This means the CPOL and CPHA are both 0. We chose Mode 0 because it is the typical default for most microcontrollers and simplifies configuring the master.

#### SPI signals

The specification for SPI includes the four signals: SPI\_MISO, SPI\_MOSI, SPI\_CLK, and SPI\_SSEL. Using only these four signals, the master cannot know when the slave needs to send and the SPI slave cannot transmit unless enabled by the master. For this reason, the SPI\_ATTN signal is available. This allows the device to alert the SPI master that it has data to send. In turn, the SPI master asserts SPI\_SSEL and starts SPI\_CLK unless these signals are already asserted and active respectively. This allows the XBee 868LP RF Module to send data to the master.

The following table names the SPI signals and specifies their pinouts. It also describes the operation of each pin.

Signal name	Pin number	Applicable AT command	Description
SPI_MISO (Master In, Slave out)	17	<b>P5</b>	When SPI_SSEL is asserted (low) and SPI_CLK is active, the device outputs the data on this line at the SPI_CLK rate. When SPI_SSEL is de-asserted (high), this output should be tri-stated such that another slave device can drive the line.

Signal name	Pin number	Applicable AT command	Description
SPI_MOSI (Master out, Slave in)	16	<b>P6</b>	The SPI master outputs data on this line at the SPI_CLK rate after it selects the desired slave. When you configure the device for SPI operations, this pin is an input.
SPI_SSEL (Slave Select) (Master out, Slave in)	15	<b>P7</b>	The SPI master outputs a low signal on this line to select the desired slave. When you configure for SPI operations, this pin is an input.
SPI_CLK (Clock) (Master out, Slave in)	14	<b>P8</b>	The SPI master outputs a clock on this pin, and the rate must not exceed the maximum allowed, 3.5 Mb/s. When you configure the device for SPI operations, this pin is an input.
SPI_ATT $\bar{N}$ (Attention) (Master in, Slave out)	12	<b>P9</b>	The device asserts this pin low when it has data to send to the SPI master. When you configure for SPI operations, it is an output (not tri-stated).

**Note** By default, the inputs have pull-up resistors enabled. See [PR \(Pull-up/Down Resistor Enable\)](#) to disable the pull-up resistors. When the SPI pins are not connected but the pins are configured for SPI operation, the pull-ups are required for proper UART operation.

### Full duplex operation

SPI on the XBee 868LP RF Module requires that you use API mode (without escaping) to packetize data. By design, SPI is a full duplex protocol even when data is only available in one direction. This means that when a device receives data, it also transmits and that data is normally invalid. Likewise, when the device transmits data, invalid data is probably received. To determine whether or not received data is invalid, we packetize the data with API packets.

SPI allows for valid data from the slave to begin before, at the same time, or after valid data begins from the master. When the master is sending data to the slave and the slave has valid data to send in the middle of receiving data from the master, this allows a true full duplex operation where data is valid in both directions for a period of time. Not only must the master and the slave both be able to keep up with the full duplex operation, but both sides must honor the protocol as specified.

The following diagram illustrates the SPI interface while valid data is being sent in both directions.

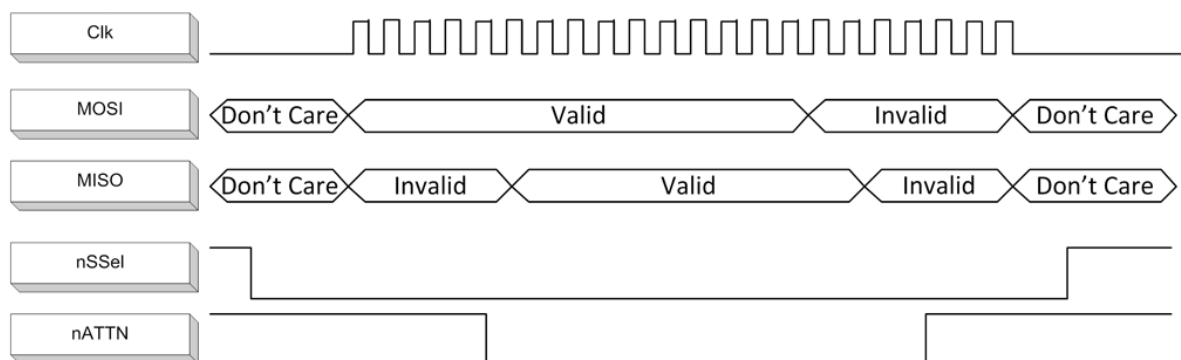

### Low power operation

Sleep modes generally work the same on SPI as they do on UART. However, due to the addition of SPI mode, there is an option of another sleep pin, as described below.

By default, Digi configures DIO8 (SLEEP\_REQUEST) as a peripheral and during pin sleep it wakes the device and puts it to sleep. This applies to both the UART and SPI serial interfaces.

If SLEEP\_REQUEST is not configured as a peripheral and SPI\_SSEL is configured as a peripheral, then pin sleep is controlled by SPI\_SSEL rather than by SLEEP\_REQUEST. Asserting SPI\_SSEL (pin 15) by driving it low either wakes the device or keeps it awake. Negating SPI\_SSEL by driving it high puts the device to sleep.

Using SPI\_SSEL to control sleep and to indicate that the SPI master has selected a particular slave device has the advantage of requiring one less physical pin connection to implement pin sleep on SPI. It has the disadvantage of putting the device to sleep whenever the SPI master negates SPI\_SSEL (meaning time is lost waiting for the device to wake), even if that was not the intent.

If the user has full control of SPI\_SSEL so that it can control pin sleep, whether or not data needs to be transmitted, then sharing the pin may be a good option in order to make the SLEEP\_REQUEST pin available for another purpose.

If the device is one of multiple slaves on the SPI, then the device sleeps while the SPI master talks to the other slave, but this is acceptable in most cases.

If you do not configure either pin as a peripheral, then the device stays awake, being unable to sleep in SM1 mode.

## Configuration considerations

The configuration considerations are:

- How do you select the serial port? For example, should you use the UART or the SPI port?
- If you use the SPI port, what data format should you use in order to avoid processing invalid characters while transmitting?
- What SPI options do you need to configure?

### Serial port selection

In the default configuration both the UART and SPI ports are configured for serial port operation. In this case, serial data goes out the UART until the host device asserts the SPI\_SSEL signal. Thereafter all serial communications operate only on the SPI interface until a reset occurs.

If you enable only the UART, the XBee 868LP RF Module uses only the UART, and ignores the SPI\_SSEL.

If you enable only the SPI, the XBee 868LP RF Module uses only the SPI, and ignores UART communications.

If neither serial port is enabled, the device will not support serial operations and all communications must occur over the air. The device discards all data that would normally go to the serial port.

### Data format

SPI only operates in API mode 1. The XBee 868LP RF Module does not support Transparent mode or API mode 2 (which escapes control characters). This means that the AP configuration only applies to the UART, and the device ignores it while using SPI.

## SPI parameters

Most host processors with SPI hardware allow you to set the bit order, clock phase and polarity. For communication with all XBee 868LP RF Modules, the host processor must set these options as follows:

- Bit order: send MSB first
- Clock phase (CPHA): sample data on first (leading) edge
- Clock polarity (CPOL): first (leading) edge rises

All XBee 868LP RF Modules use SPI mode 0 and MSB first. Mode 0 means that data is sampled on the leading edge and that the leading edge rises. MSB first means that bit 7 is the first bit of a byte sent over the interface.

## Serial buffers

To enable the UART port, `DIN` and `DOUT` must be configured as peripherals. To enable the SPI port, `SPI_MISO`, `SPI_MOSI`, `SPI_SSEL`, and `SPI_CLK` must be enabled as peripherals. If both ports are enabled, output goes to the UART until the first input on SPI. This is the default configuration.

When input occurs on either port, that port is selected as the active port and no input or output is allowed on the other port until the next reset of the module.

If you change the configuration to configure only one port, that port is the only one enabled or used. If the parameters are written with only one port enabled, the port that is not enabled is not used even temporarily after the next reset.

If both ports are disabled on reset, the device uses the UART regardless of the incorrect configuration to ensure that at least one serial port is operational.

### Serial receive buffer

When serial data enters the device through the `DIN` pin (or the `MOSI` pin), it stores the data in the serial receive buffer until the device can process it. Under certain conditions, the device may not be able to process data in the serial receive buffer immediately. If large amounts of serial data are sent to the device such that the serial receive buffer would overflow, then it discards new data. If the UART is in use, you can avoid this by the host side honoring CTS flow control.

If the SPI is the serial port, no hardware flow control is available. It is your responsibility to ensure that the receive buffer does not overflow. One reliable strategy is to wait for a `TX_STATUS` response after each frame sent to ensure that the device has had time to process it.

### Serial transmit buffer

When the device receives RF data, it moves the data into the serial transmit buffer and sends it out the UART or SPI port. If the serial transmit buffer becomes full and the system buffers are also full, then it drops the entire RF data packet. Whenever the device receives data faster than it can process and transmit the data out the serial port, there is a potential of dropping data.

## UART flow control

You can use the `RTS` and `CTS` pins to provide `RTS` and/or `CTS` flow control. `CTS` flow control provides an indication to the host to stop sending serial data to the device. `RTS` flow control allows the host to signal the device to not send data in the serial transmit buffer out the UART. To enable `RTS/CTS` flow control, use the **D6** and **D7** commands.

---

**Note** Serial port flow control is not possible when using the SPI port.

---

## CTS flow control

If you enable CTS flow control (**D7** command), when the serial receive buffer is 17 bytes away from being full, the device de-asserts  $\overline{\text{CTS}}$  (sets it high) to signal to the host device to stop sending serial data. The device reasserts  $\overline{\text{CTS}}$  after the serial receive buffer has 34 bytes of space. See [FT \(Flow Control Threshold\)](#) for the buffer size.

In either case,  $\overline{\text{CTS}}$  is not re-asserted until the serial receive buffer has **FT-17** or less bytes in use.

## RTS flow control

If you send the **D6** command to enable  $\overline{\text{RTS}}$  flow control, the device does not send data in the serial transmit buffer out the DOUT pin as long as  $\overline{\text{RTS}}$  is de-asserted (set high). Do not de-assert  $\overline{\text{RTS}}$  for long periods of time or the serial transmit buffer will fill. If the device receives an RF data packet and the serial transmit buffer does not have enough space for all of the data bytes, it discards the entire RF data packet.

The UART Data Present Indicator is a useful feature when using  $\overline{\text{RTS}}$  flow control. When enabled, the DIO19 line asserts (low asserted) when UART data is queued to be transmitted from the device. For more information, see [P9 \(SPI\\_ATTEN\)](#).

If the device sends data out the UART when  $\overline{\text{RTS}}$  is de-asserted (set high) the device could send up to five characters out the UART port after  $\overline{\text{RTS}}$  is de-asserted.

## Force UART operation

### Condition

You configure a device with only the SPI enabled and no SPI master is available to access the SPI slave port

### Solution

Use the following steps to recover the device to UART operation:

1. Hold the DIN/CONFIG low at reset time.
2. DIN/CONFIG forces a default configuration on the UART at 9600 baud and brings up the device in Command Mode on the UART port.  
You can send the appropriate commands to the device to configure it for UART operation.
3. If you write these parameters to the device, the module comes up with the UART enabled on the next reset.

## Serial interface protocols

The XBee 868LP RF Module supports both Transparent and Application Programming Interface (API) serial interfaces.

### Transparent operating mode

When operating in Transparent mode, the devices act as a serial line replacement. The device queues up all UART data received through the DIN pin for RF transmission. When RF data is received, the device sends the data out through the serial port. Use the Command mode interface to configure the device configuration parameters.

**Note** Transparent operation is not available when using SPI.

The device buffers data in the serial receive buffer and packetizes and transmits the data when it receives the following:

- No serial characters for the amount of time determined by the **RO** (Packetization Timeout) parameter. If **RO** = 0, packetization begins when the device received a character.
- Command Mode Sequence (**GT** + **CC** + **GT**). Any character buffered in the serial receive buffer before the device transmits the sequence.
- Maximum number of characters that fit in an RF packet.

### API operating mode

API operating mode is an alternative to Transparent operating mode. The frame-based API extends the level to which a host application can interact with the networking capabilities of the device. When in API mode, the device contains all data entering and leaving in frames that define operations or events within the device.

The API provides alternative means of configuring devices and routing data at the host application layer. A host application can send data frames to the device that contain address and payload information instead of using Command mode to modify addresses. The device sends data frames to the application containing status packets, as well as source and payload information from received data packets.

The API operation option facilitates many operations such as:

- Transmitting data to multiple destinations without entering Command Mode
- Receive success/failure status of each transmitted RF packet
- Identify the source address of each received packet

### Comparing Transparent and API modes

The following table compares the advantages of transparent and API modes of operation:

Feature	Description
<b>Transparent mode features</b>	
Simple interface	All received serial data is transmitted unless the device is in Command mode
Easy to support	It is easier for an application to support Transparent operation and Command mode
<b>API mode features</b>	
Easy to manage data transmissions to multiple destinations	Transmitting RF data to multiple remote devices only requires the application to change the address in the API frame. This process is much faster than in Transparent mode where the application must enter Command mode, change the address, exit Command mode, and then transmit data.

Feature	Description
Each API transmission can return a transmit status frame indicating the success or reason for failure	Because acknowledgments are sent out of the serial interface, this provides more information about the health of the RF network and can be used to debug issues after the network has been deployed.
Received data frames indicate the sender's address	All received RF data API frames indicate the source address
Advanced addressing support	API transmit and receive frames can expose addressing fields including source and destination endpoints, cluster ID, and profile ID
Advanced networking diagnostics	API frames can provide indication of I/O samples from remote devices, and node identification messages.
Remote Configuration	Set/read configuration commands can be sent to remote devices to configure them as needed using the API

We recommend API mode when a device:

- Sends RF data to multiple destinations
- Sends remote configuration commands to manage devices in the network
- Receives RF data packets from multiple devices, and the application needs to know which device sent which packet
- Must support multiple endpoints, cluster IDs, and/or profile IDs
- Uses the Device Profile services

API mode is required when:

- Receiving I/O samples from remote devices
- Using SPI for the serial port

If the conditions listed above do not apply (for example, a sensor node, router, or a simple application), then Transparent operation might be suitable. It is acceptable to use a mixture of devices running API mode and Transparent mode in a network.

## Modes

---

The XBee 868LP RF Module is in Receive Mode when it is not transmitting data. The device shifts into the other modes of operation under the following conditions:

- Transmit mode (Serial data in the serial receive buffer is ready to be packetized)
- Sleep mode
- Command Mode (Command mode sequence is issued (not available when using the SPI port))

Transmit mode .....	81
Receive mode .....	81
Command mode .....	81
Sleep mode .....	84



## Transmit mode

When the device receives serial data and is ready to packetize it, the device attempts to transmit the serial data. The destination address determines which node(s) will receive and send the data.

In the following diagram, route discovery applies only to DigiMesh transmissions. Once route discovery establishes a route, the device transmits the data. If route discovery fails to establish a route, the device discards the packet.

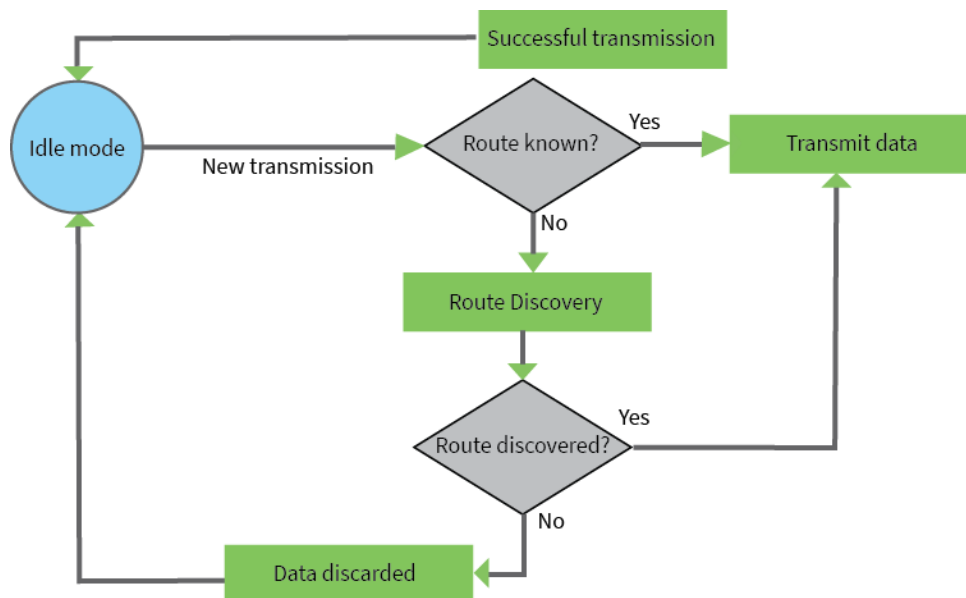

When DigiMesh data is transmitted from one node to another, the destination node transmits a network-level acknowledgment back across the established route to the source node. This acknowledgment packet indicates to the source node that the destination node received the data packet. If the source node does not receive a network acknowledgment, it retransmits the data.

For more information, see [Data transmission and routing](#).

## Receive mode

This is the default mode for the XBee 868LP RF Module. The device is in Receive mode when it is not transmitting data. If a destination node receives a valid RF packet, the destination node transfers the data to its serial transmit buffer.

## Command mode

Command mode is a state in which the firmware interprets incoming characters as commands. It allows you to modify the device's configuration using parameters you can set using AT commands. When you want to read or set any parameter of the XBee 868LP RF Module using this mode, you have to send an AT command. Every AT command starts with the letters **AT** followed by the two characters that identify the command and then by some optional configuration values.

The operating modes of the XBee 868LP RF Module are controlled by the [API Mode](#) setting, but Command mode is always available as a mode the device can enter while configured for any of the operating modes.

Command mode is available on the UART interface for all operating modes. You cannot use the SPI interface to enter Command mode.

## Enter Command mode

To get a device to switch into Command mode, you must issue the following sequence: **+++** within one second. There must be at least one second preceding and following the **+++** sequence. Both the command character (**CC**) and the silence before and after the sequence (**GT**) are configurable. When the entrance criteria are met the device responds with **OK\r** on UART signifying that it has entered Command mode successfully and is ready to start processing AT commands.

If configured to operate in [Transparent operating mode](#), when entering Command mode the XBee 868LP RF Module knows to stop sending data and start accepting commands locally.

---

**Note** Do not press **Return** or **Enter** after typing **+++** because it interrupts the guard time silence and prevents you from entering Command mode.

---

When the device is in Command mode, it listens for user input and is able to receive AT commands on the UART. If **CT** time (default is 10 seconds) passes without any user input, the device drops out of Command mode and returns to the previous operating mode. You can force the device to leave Command mode by sending [CN command](#).

You can customize the command character, the guard times and the timeout in the device's configuration settings. For more information, see [CC \(Command Sequence Character\)](#), [CT command](#) and [GT command](#).

## Troubleshooting

Failure to enter Command mode is often due to baud rate mismatch. Ensure that the baud rate of the connection matches the baud rate of the device. By default, [BD \(Baud Rate\)](#) = **3** (9600 b/s).

There are two alternative ways to enter Command mode:

- A serial break for six seconds enters Command mode. You can issue the "break" command from a serial console, it is often a button or menu item.
- Asserting DIN (serial break) upon power up or reset enters Command mode. XCTU guides you through a reset and automatically issues the break when needed.

Both of these methods temporarily set the device's baud rate to 9600 and return an **OK** on the UART to indicate that Command mode is active. When Command mode exits, the device returns to normal operation at the baud rate that **BD** is set to.

## Send AT commands

Once the device enters Command mode, use the syntax in the following figure to send AT commands. Every AT command starts with the letters **AT**, which stands for "attention." The AT is followed by two characters that indicate which command is being issued, then by some optional configuration values.

To read a parameter value stored in the device's register, omit the parameter field.

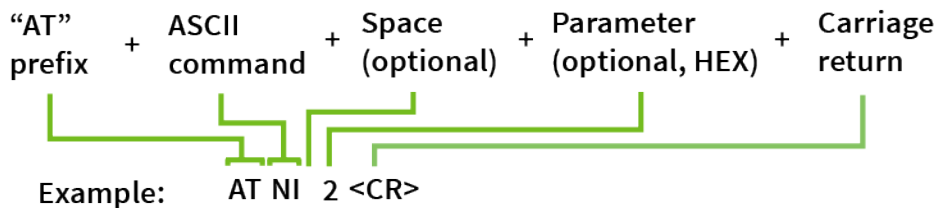

The preceding example changes [NI command](#) to **My XBee**.

### Multiple AT commands

You can send multiple AT commands at a time when they are separated by a comma in Command mode; for example, **ATNIMy XBee,AC<cr>**.

The preceding example changes the **NI (Node Identifier)** to **My XBee** and makes the setting active through **AC (Apply Changes)**.

### Parameter format

Refer to the list of **AT commands** for the format of individual AT command parameters. Valid formats for hexadecimal values include with or without a leading **0x** for example **FFFF** or **0xFFFF**.

### Response to AT commands

When using AT commands to set parameters the XBee 868LP RF Module responds with **OK<cr>** if successful and **ERROR<cr>** if not.

For devices with a file system:

**ATAP1<cr>**

**OK<cr>**

When reading parameters, the device returns the current parameter value instead of an **OK** message.

**ATAP<cr>**

**1<cr>**

### Apply command changes

Any changes you make to the configuration command registers using AT commands do not take effect until you apply the changes. For example, if you send the **BD** command to change the baud rate, the actual baud rate does not change until you apply the changes. To apply changes:

1. Send **AC (Apply Changes)**.
  2. Send **WR command**.
- or:
3. **Exit Command mode**.

### Make command changes permanent

Send a **WR command** command to save the changes. **WR** writes parameter values to non-volatile memory so that parameter modifications persist through subsequent resets.

Send as **RE command** to wipe settings saved using **WR** back to their factory defaults.

---

**Note** You still have to use **WR** to save the changes enacted with **RE**.

---

### Exit Command mode

1. Send **CN command** followed by a carriage return.
- or:
2. If the device does not receive any valid AT commands within the time specified by **CT command**, it returns to Transparent or API mode. The default Command mode timeout is 10 seconds.

For an example of programming the device using AT Commands and descriptions of each configurable parameter, see [AT commands](#).

## Sleep mode

Sleep modes allow the device to enter states of low power consumption when not in use. The XBee 868LP RF Module supports both pin sleep (Sleep mode entered on pin transition) and cyclic sleep (device sleeps for a fixed time).

Sleep modes allow the device to enter states of low power consumption when not in use. XBee devices support both pin sleep, where the device enters sleep mode upon pin transition, and cyclic sleep, where the device sleeps for a fixed time. For more information, see [Sleep modes](#).

## Sleep modes

---

About sleep modes .....	86
Normal mode .....	86
Asynchronous pin sleep mode .....	87
Asynchronous cyclic sleep mode .....	87
Asynchronous cyclic sleep with pin wake up mode .....	87
Synchronous sleep support mode .....	87
Synchronous cyclic sleep mode .....	87
Wake timer .....	88
Indirect messaging and polling .....	88
Sleeping routers .....	89
Sleep coordinator sleep modes in the DigiMesh network .....	89

## About sleep modes

A number of low-power modes exist to enable devices to operate for extended periods of time on battery power. Use the **SM** command to enable these sleep modes. The sleep modes are characterized as either:

- Asynchronous (**SM** = 1, 4, 5).
- Synchronous (**SM** = 7, 8).

### Asynchronous modes

- Do not use asynchronous sleep modes in a synchronous sleeping network, and vice versa.
- Use the asynchronous sleep modes to control the sleep state on a device by device basis.
- Do not use devices operating in asynchronous sleep mode to route data.
- We strongly encourage you to set asynchronous sleeping devices as end-devices using the **CE** command. This prevents the node from attempting to route data.

### Synchronous modes

Synchronous sleep makes it possible for all nodes in the network to synchronize their sleep and wake times. All synchronized cyclic sleep nodes enter and exit a low power state at the same time.

This forms a cyclic sleeping network.

- A device acting as a sleep coordinator sends a special RF packet called a sync message to synchronize nodes.
- To make a device in the network a coordinator, a node uses several resolution criteria through a process called nomination.
- The sleep coordinator sends one sync message at the beginning of each wake period. The coordinator sends the sync message as a broadcast and every node in the network repeats it.
- You can change the sleep and wake times for the entire network by locally changing the settings on an individual device. The network uses the most recently set sleep settings.

## Normal mode

Set **SM** to 0 to enter Normal mode.

Normal mode is the default sleep mode. If a device is in this mode, it does not sleep and is always awake.

Use mains-power for devices in Normal mode.

A device in Normal mode synchronizes to a sleeping network, but does not observe synchronization data routing rules; it routes data at any time, regardless of the network's wake state.

When synchronized, a device in Normal mode relays sync messages that sleep-compatible nodes generate, but does not generate sync messages itself.

Once a device in Normal mode synchronizes with a sleeping network, you can put it into a sleep-compatible sleep mode at any time.

## Asynchronous pin sleep mode

Set **SM** to 1 to enter asynchronous pin sleep mode.

Pin sleep allows the device to sleep and wake according to the state of the  $\overline{\text{SLEEP\_RQ}}$  pin (pin 9).

When you assert SLEEP\_RQ (high), the device finishes any transmit or receive operations and enters a low-power state.

When you de-assert SLEEP\_RQ (low), the device wakes from pin sleep.

## Asynchronous cyclic sleep mode

Set **SM** to 4 to enter asynchronous cyclic sleep mode.

Cyclic sleep allows the device to sleep for a specific time and wake for a short time to poll.

If the device receives serial or RF data while awake, it extends the time before it returns to sleep by the specific amount the **ST** command provides. Otherwise, it enters sleep mode immediately.

The  $\overline{\text{ON\_SLEEP}}$  line asserts (high) when the device wakes, and is de-asserted (low) when the device sleeps.

If you use the **D7** command to enable hardware flow control, the  $\overline{\text{CTS}}$  pin asserts (low) when the device wakes and can receive serial data, and de-asserts (high) when the device sleeps.

## Asynchronous cyclic sleep with pin wake up mode

Set **SM** to 5 to enter Asynchronous cyclic sleep with pin wake up mode.

This mode is a slight variation on (**SM** = 4) that allows the device to wake prematurely by asserting the SLEEP\_RQ pin (pin 9). In (**SM** = 5), the device wakes after the sleep period expires, or if a high-to-low transition occurs on the SLEEP\_RQ pin.

## Synchronous sleep support mode

Set **SM** to 7 to enter synchronous sleep support mode.

A device in synchronous sleep support mode synchronizes itself with a sleeping network but will not itself sleep. At any time, the device responds to new devices that are attempting to join the sleeping network with a sync message. A sleep support device only transmits normal data when the other devices in the sleeping network are awake. You can use sleep support devices as preferred sleep coordinator devices and as aids in adding new devices to a sleeping network.

## Synchronous cyclic sleep mode

Set **SM** to 8 to enter synchronous cyclic sleep mode.

A device in synchronous cyclic sleep mode sleeps for a programmed time, wakes in unison with other nodes, exchanges data and sync messages, and then returns to sleep. While asleep, it cannot receive RF messages or receive data (including commands) from the UART port.

Generally, the network's sleep coordinator specifies the sleep and wake times based on its **SP** and **ST** settings. The device only uses these parameters at startup until the device synchronizes with the network.

When a device has synchronized with the network, you can query its sleep and wake times with the **OS** and **OW** commands respectively.

If **D9** = 1 ( $\overline{\text{ON\_SLEEP}}$  enabled) on a cyclic sleep node, the  $\overline{\text{ON\_SLEEP}}$  line asserts when the device is awake and de-asserts when the device is asleep.

If **D7** = 1, the device de-asserts  $\overline{\text{CTS}}$  while asleep.

A newly-powered, unsynchronized, sleeping device polls for a synchronized message and then sleeps for the period that the **SP** command specifies, repeating this cycle until it synchronizes by receiving a sync message. Once it receives a sync message, the device synchronizes itself with the network.

---

**Note** Configure all nodes in a synchronous sleep network to operate in either synchronous sleep support mode or synchronous cyclic sleep mode. asynchronous sleeping nodes are not compatible with synchronous sleeping nodes.

---

## Wake timer

In asynchronous cyclic sleep mode (**SM** = 4 or **SM** = 5), if a device receives serial or RF data, it starts a sleep timer (time until sleep). Any data received serially or by RF link resets the timer. Use **ST** ([Wake Time](#)) to set the timer duration. While the device is awake, it sends regular poll requests to its parent to check for buffered data. If the RF data rate is 80 kb/s (**BR** = 1), the poll occurs every 100 ms. Otherwise, (**BR** = 0), the poll occurs every 300 ms. The device returns to sleep when the sleep timer expires.

## Indirect messaging and polling

To enable reliable communication with sleeping devices, you can use the **CE** (Routing/Messaging Mode) command to enable indirect messaging and polling.

### Indirect messaging

Indirect messaging is a communication mode designed for communicating with asynchronous sleeping devices. A device can enable indirect messaging by making itself an indirect messaging coordinator with the **CE** command. An indirect messaging coordinator does not immediately transmit a P2MP unicast when it is received over the serial port. Instead the device holds onto the data until it is requested via a poll. On receiving a poll, the indirect messaging coordinator sends a queued data packet (if available) to the requestor.

Because it is possible for a polling device to be eliminated, a mechanism is in place to purge unrequested data packets. If the coordinator holds an indirect data packet for an indirect messaging poller for more than 2.5 times its **SP** value, then the packet is purged. We suggest setting the **SP** of the coordinator to the same value as the highest **SP** time that exists among the pollers in the network. If the coordinator is in API mode, a TxStatus message is generated for a purged data packet with a status of 0x75 (**INDIRECT\_MESSAGE\_UNREQUESTED**).

An indirect messaging coordinator queues up as many data packets as it has buffers available. After the coordinator uses all of its available buffers, it holds transmission requests unprocessed on the serial input queue. After the serial input queue is full, the device de-asserts  $\overline{\text{CTS}}$  (if hardware flow control is enabled). After receiving a poll or purging data from the indirect messaging queue the buffers become available again.

Indirect messaging only functions with P2MP unicast messages. Indirect messaging has no effect on P2MP broadcasts, directed broadcasts, repeater packets, or DigiMesh packets. These messages are sent immediately when received over the serial port and are not put on the indirect messaging queue.

### Polling

Polling is the automatic process by which a node can request data from an indirect messaging coordinator. To enable polling on a device, configure it as an end device with the **CE** command. When you enable polling, the device sends a poll request a minimum of once every 100 ms. When the device



sends normal data to the destination specified by the **DH/DL** of end device module, the data also functions as a poll.

When a polling device is also an asynchronous sleeping device, that device sends a poll shortly after waking from sleep. After that first poll is sent, the device sends polls in the normal manner described previously until it returns to sleep.

## Sleeping routers

The Sleeping Router feature of DigiMesh makes it possible for all nodes in the network to synchronize their sleep and wake times. All synchronized cyclic sleep nodes enter and exit a low power state at the same time. This forms a cyclic sleeping network.

Devices synchronize by receiving a special RF packet called a sync message sent by a device acting as a sleep coordinator. A device in the network becomes a sleep coordinator through a process called nomination. The sleep coordinator sends one sync message at the beginning of each wake period. The device sends a sync message as a broadcast that is repeated by every device in the network. To change the sleep and wake times for the entire network, change the settings on an individual node locally. The network uses the most recently set sleep settings.

For more information, see [Become a sleep coordinator](#).

## Sleep coordinator sleep modes in the DigiMesh network

In a synchronized sleeping network, one node acts as the sleep coordinator. During normal operations, at the beginning of a wake cycle the sleep coordinator sends a sync message as a broadcast to all nodes in the network. This message contains synchronization information and the wake and sleep times for the current cycle. All cyclic sleep nodes that receive a sync message remain awake for the wake time and then sleep for the specified sleep period.

The sleep coordinator sends one sync message at the beginning of each cycle with the current wake and sleep times. All router nodes that receive this sync message relay the message to the rest of the network. If the sleep coordinator does not hear a rebroadcast of the sync message by one of its immediate neighbors, then it re-sends the message one additional time.

If you change the **SP** or **ST** parameters, the network does not apply the new settings until the beginning of the next wake time. For more information, see [Change sleep parameters](#).

A sleeping router network is robust enough that an individual node can go several cycles without receiving a sync message, due to RF interference, for example. As a node misses sync messages, the time available for transmitting messages during the wake time reduces to maintain synchronization accuracy. By default, a device reduces its active sleep time progressively as it misses sync messages.

## Synchronization messages

A sleep coordinator regularly sends sync messages to keep the network in sync. Unsynchronized nodes also send messages requesting sync information.

Sleep compatible nodes use Deployment mode when they first power up and the sync message has not been relayed. A sleep coordinator in Deployment mode rapidly sends sync messages until it receives a relay of one of those messages. Deployment mode:

- Allows you to effectively deploy a network.
- Allows a sleep coordinator that resets to rapidly re-synchronize with the rest of the network.

If a node exits deployment mode and then receives a sync message from a sleep coordinator that is in Deployment mode, it rejects the sync message and sends a corrective sync to the sleep coordinator.

Use the **SO** (sleep options) command to disable deployment mode. This option is enabled by default.

A sleep coordinator that is not in deployment mode sends a sync message at the beginning of the wake cycle. The sleep coordinator listens for a neighboring node to relay the sync. If it does not hear the relay, the sleep coordinator sends the sync one additional time.

A node that is not a sleep coordinator and has never been synchronized sends a message requesting sync information at the beginning of its wake cycle. Synchronized nodes which receive one of these messages respond with a synchronization packet.

If you use the **SO** command to configure nodes as non-coordinators, and if the non-coordinators go six or more sleep cycles without hearing a sync, they send a message requesting sync at the beginning of their wake period.

The following diagram illustrates the synchronization behavior of sleep compatible devices.

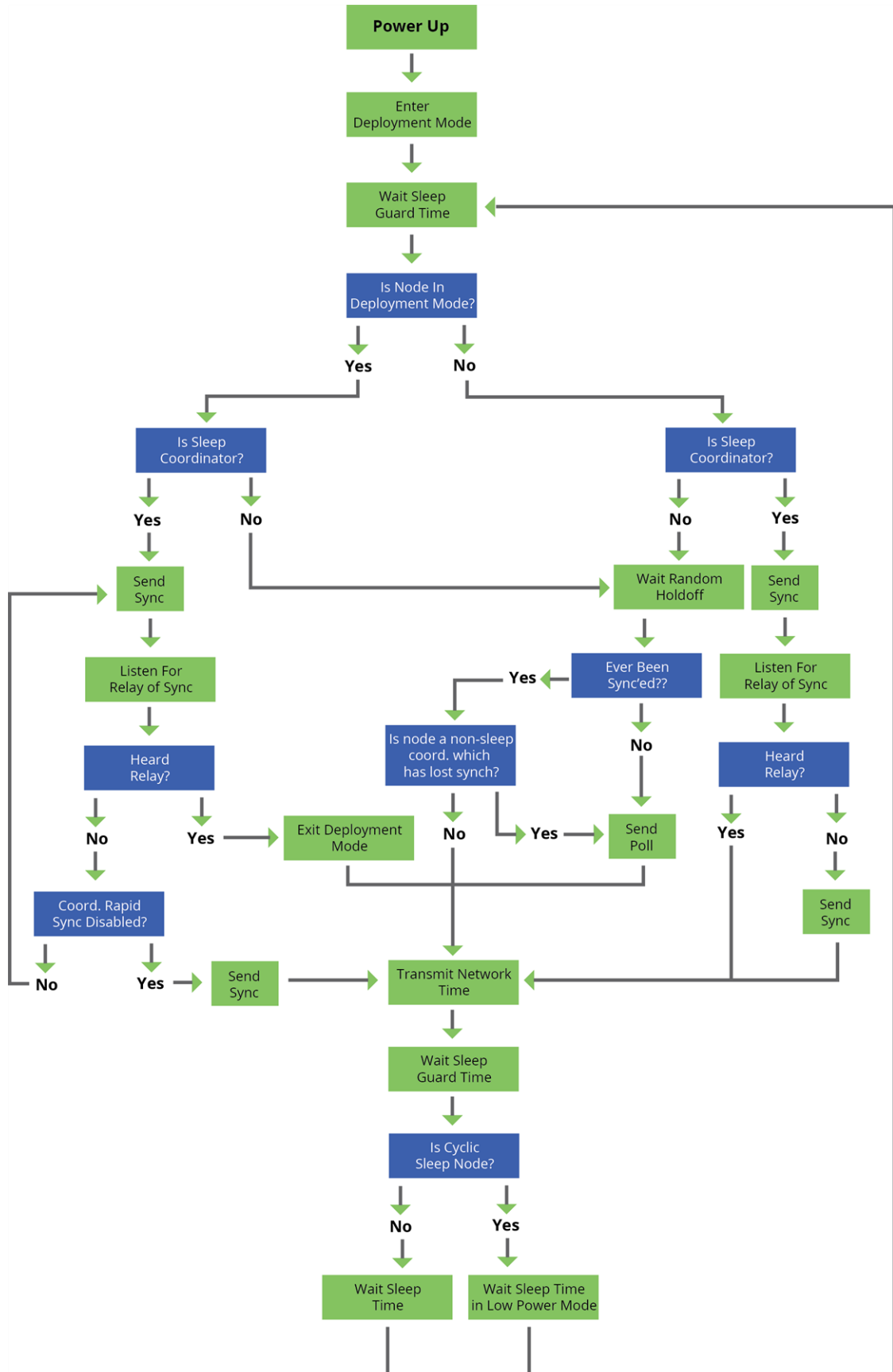

## Become a sleep coordinator

In DigiMesh networks, a device can become a sleep coordinator in one of four ways:

- Define a preferred sleep coordinator
- A potential sleep coordinator misses three or more sync messages
- Press the Commissioning Pushbutton twice on a potential sleep coordinator
- Change the sleep timing values on a potential sleep coordinator

### *Preferred sleep coordinator option*

You can specify that a node always act as a sleep coordinator. To do this, set the preferred sleep coordinator bit (bit 0) in the **SO** command to 1.

A node with the sleep coordinator bit set always sends a sync message at the beginning of a wake cycle. To avoid network congestion and synchronization conflicts, do not set this bit on more than one node in the network.

Although it is not necessary to specify a preferred sleep coordinator, doing so improves network performance.

A node that is centrally located in the network can serve as a good sleep coordinator, because it minimizes the number of hops a sync message takes to get across the network.

A sleep support node and/or a node that is mains powered is a good candidate to be a sleep coordinator.



**CAUTION!** Use the preferred sleep coordinator bit with caution. The advantages of using the option become weaknesses if you use it on a node that is not in the proper position or configuration.

---

You can also use the preferred sleep coordinator option when you set up a network for the first time. When you start a network, you can configure a node as a sleep coordinator so it will begin sending sleep messages. After you set up the network, disable the preferred sleep coordinator bit.

### *Resolution criteria and selection option*

There is an optional selection process with resolution criteria that occurs on a node if it loses contact with the network sleep coordinator. By default, this process is disabled. Use the **SO** command to enable this process. This process occurs automatically if a node loses contact with the previous sleep coordinator.

If you enable the process on any sleep compatible node, it is eligible to become the sleep coordinator for the network.

A sleep compatible node may become a sleep coordinator if it:

- Misses three or more sync messages.
- Is not configured as a non-coordinator (presumably because the sleep coordinator has been disabled).

Depending on the platform and other configurable options, such a node eventually uses the selection process after a number of sleep cycles without a sync.

A node that uses the selection process begins acting as the new network sleep coordinator.

It is possible for multiple nodes to declare themselves as the sleep coordinator. If this occurs, the firmware uses the following resolution criteria to identify the sleep coordinator from among the nodes using the selection process:

1. Newer sleep parameters: the network considers a node using newer sleep parameters (**SP** and **ST**) as higher priority to a node using older sleep parameters. See [Change sleep parameters](#).
2. Preferred sleep coordinator: a node acting as a preferred sleep coordinator is higher priority to other nodes.
3. Sleep support node: sleep support nodes are higher priority to cyclic sleep nodes. You can modify this behavior using the **SO** parameter.
4. Serial number: If the previous factors do not resolve the priority, the network considers the node with the higher serial number to be higher priority.

### **Commissioning Pushbutton option**

Use the Commissioning Pushbutton to select a device to act as the sleep coordinator.

If you enable the Commissioning Pushbutton functionality, you can immediately select a device as a sleep coordinator by pressing the Commissioning Pushbutton twice or by issuing the **CB2** command. The device you select in this manner is still subject to the resolution criteria process.

Only sleep coordinator nodes honor Commissioning Pushbutton nomination requests. A node configured as a non-sleep coordinator ignores commissioning button nomination requests.

### **Change sleep parameters**

Any sleep compatible node in the network that does not have the non-coordinator sleep option set can make changes to the network's sleep and wake times. If you change a node's **SP** or **ST** to values different from those that the network is using, the node becomes the sleep coordinator. The node begins sending sync messages with the new sleep parameters at the beginning of the next wake cycle.

- For normal operations, a device uses the sleep and wake parameters it gets from the sleep sync message, not the ones specified in its **SP** and **ST** parameters. It does not update the **SP** and **ST** parameters with the values of the sync message. Use the **OS** and **OW** commands to query the operating network sleep and wake times currently being used by the node.
- Changing network parameters can cause a node to become a sleep coordinator and change the sleep settings of the network. The following commands can cause this to occur: **NH**, **NN**, **NQ**, and **MR**.

For most applications, we recommend configuring the **NH**, **NN**, **NQ**, and **MR** network parameters during initial deployment only.

### **Sleep guard times**

To compensate for variations in the timekeeping hardware of the various devices in a sleeping router network, the network allocates sleep guard times at the beginning and end of the wake period. The size of the sleep guard time varies based on the sleep and wake times you select and the number of sleep cycles that elapse since receiving the last sync message. The sleep guard time guarantees that a destination module will be awake when the source device sends a transmission. As a node misses more and more consecutive sync messages, the sleep guard time increases in duration and decreases the available transmission time.

### **Auto-early wake-up sleep option**

Similar to the sleep guard time, the auto early wake-up option decreases the sleep period based on the number of sync messages a node misses. This option comes at the expense of battery life.

Use the **SO** command to disable auto-early wake-up sleep. This option is enabled by default.

### **Select sleep parameters**

Choosing proper sleep parameters is vital to creating a robust sleep-enabled network with a desirable battery life. To select sleep parameters that will be good for most applications, follow these steps:

1. Choose **NH**.

Based on the placement of the nodes in your network, select the appropriate values for the **NH** (Network Hops) parameter .

We optimize the default values of **NH** to work for the majority of deployments. In most cases, we suggest that you do not modify these parameters from their default values.

Decreasing these parameters for small networks can improve battery life, but take care to not make the values too small.

2. Calculate the Sync Message Propagation Time (SMPT).

This is the maximum amount of time it takes for a sleep synchronization message to propagate to every node in the network. You can estimate this number with the following formula:

$$\text{SMPT} = \text{NH} * (\text{MT} + 1) * 18 \text{ ms.}$$

3. Select the duty cycle you want.

The ratio of sleep time to wake time is the factor that has the greatest effect on the device's power consumption. Battery life can be estimated based on the following factors:

- sleep period
- wake time
- sleep current
- RX current
- TX current
- battery capacity

4. Choose the sleep period and wake time.

The wake time must be long enough to transmit the desired data as well as the sync message. The **ST** parameter automatically adjusts upwards to its minimum value when you change other AT commands that affect it (**SP**, and **NH**).

Use a value larger than this minimum. If a device misses successive sync messages, it reduces its available transmit time to compensate for possible clock drift. Budget a large enough **ST** time to allow for the device to miss a few sync messages and still have time for normal data transmissions.

### **Start a sleeping synchronous network**

By default, all new nodes operate in normal (non-sleep) mode. To start a synchronous sleeping network, follow these steps:

1. Set **SO** to 1 to enable the preferred sleep coordinator option on one of the nodes.
2. Set its **SM** to a synchronous sleep compatible mode (7 or 8) with its **SP** and **ST** set to a quick cycle time. The purpose of a quick cycle time is to allow the network to send commands quickly through the network during commissioning.
3. Power on the new nodes within range of the sleep coordinator. The nodes quickly receive a sync message and synchronize themselves to the short cycle **SP** and **ST** set on the sleep coordinator.
4. Configure the new nodes to the sleep mode you want, either cyclic sleeping modes or sleep support modes.
5. Set the **SP** and **ST** values on the sleep coordinator to the values you want for the network.
6. Wait a sleep cycle for the sleeping nodes to sync themselves to the new **SP** and **ST** values.
7. Disable the preferred sleep coordinator option bit on the sleep coordinator unless you want a preferred sleep coordinator.
8. Deploy the nodes to their positions.

Alternatively, prior to deploying the network you can use the **WR** command to set up nodes with their sleep settings pre-configured and written to flash. If this is the case, you can use the Commissioning Pushbutton and associate LED to aid in deployment:

1. If you are going to use a preferred sleep coordinator in the network, deploy it first.
2. If there will not be a preferred sleep coordinator, select a node for deployment, power it on and press the Commissioning Pushbutton twice. This causes the node to begin emitting sync messages.
3. Verify that the first node is emitting sync messages by watching its associate LED. A slow blink indicates that the node is acting as a sleep coordinator.
4. Power on nodes in range of the sleep coordinator or other nodes that have synchronized with the network. If the synchronized node is asleep, you can wake it by pressing the Commissioning Pushbutton once.
5. Wait a sleep cycle for the new node to sync itself.
6. Verify that the node syncs with the network. The associate LED blinks when the device is awake and synchronized.
7. Continue this process until you deploy all of the nodes.

## Add a new node to an existing network

To add a new node to the network, the node must receive a sync message from a node already in the network. On power-up, an unsynchronized, sleep compatible node periodically sends a broadcast requesting a sync message and then sleeps for its **SP** period. Any node in the network that receives this message responds with a sync. Because the network can be asleep for extended periods of time, and cannot respond to requests for sync messages, there are methods you can use to sync a new node while the network is asleep.

1. Power the new node on within range of a sleep support node. Sleep support nodes are always awake and able to respond to sync requests promptly.

2. You can wake a sleeping cyclic sleep node in the network using the Commissioning Pushbutton. Place the new node in range of the existing cyclic sleep node. Wake the existing node by holding down the Commissioning Pushbutton for two seconds, or until the node wakes. The existing node stays awake for 30 seconds and responds to sync requests while it is awake.

If you do not use one of these two methods, you must wait for the network to wake up before adding the new node.

Place the new node in range of the network with a sleep/wake cycle that is shorter than the wake period of the network.

The new node periodically sends sync requests until the network wakes up and it receives a sync message.

## Change sleep parameters

To change the sleep and wake cycle of the network, select any sleep coordinator capable node in the network and change the **SP** and/or **ST** of the node to values different than those the network currently uses.

- If you use a preferred sleep coordinator or if you know which node acts as the sleep coordinator, we suggest that you use this node to make changes to network settings.
- If you do not know the network sleep coordinator, you can use any node that does not have the non-sleep coordinator sleep option bit set. For details on the bit, see [SO command](#).

When you make changes to a node's sleep parameters, that node becomes the network's sleep coordinator unless it has the non-sleep coordinator option selected. It sends a sync message with the new sleep settings to the entire network at the beginning of the next wake cycle. The network immediately begins using the new sleep parameters after it sends this sync.

Changing sleep parameters increases the chances that nodes will lose sync. If a node does not receive the sync message with the new sleep settings, it continues to operate on its old settings. To minimize the risk of a node losing sync and to facilitate the re-syncing of a node that does lose sync, take the following precautions:

1. Whenever possible, avoid changing sleep parameters.
2. Enable the missed sync early wake up sleep option in the **SO** command. This option is enabled by default. This command tells a node to wake up progressively earlier based on the number of cycles it goes without receiving a sync. This increases the probability that the un-synced node will be awake when the network wakes up and sends the sync message.

---

**Note** Using this sleep option increases reliability but may decrease battery life. Nodes using this sleep option that miss sync messages increase their wake time and decrease their sleep time during cycles where they miss the sync message. This increases power consumption.

---

When you are changing between two sets of sleep settings, choose settings so that the wake periods of the two sleep settings occur at the same time. In other words, try to satisfy the following equation:

$$(SP_1 + ST_1) = N * (SP_2 + ST_2)$$

where  $SP_1/ST_1$  and  $SP_2/ST_2$  are the desired sleep settings and N is an integer.

## Rejoin nodes that lose sync

DigiMesh networks get their robustness from routing redundancies which may be available. We recommend architecting the network with redundant mesh nodes to increase robustness.



If a scenario exists where the only route connecting a subnet to the rest of the network depends on a single node, and that node fails or the wireless link fails due to changing environmental conditions (a catastrophic failure condition), then multiple subnets may arise using the same wake and sleep intervals. When this occurs the first task is to repair, replace, and strengthen the weak link with new and/or redundant devices to fix the problem and prevent it from occurring in the future.

When you use the default DigiMesh sleep parameters, separated subnets do not drift out of phase with each other. Subnets can drift out of phase with each other if you configure the network in one of the following ways:

- If you disable the non-sleep coordinator bit in the **SO** command on multiple devices in the network, they are eligible for the network to nominate them as a sleep coordinator. For more details, see [SO command](#).
- If the devices in the network do not use the auto early wake-up sleep option.

If a network has multiple subnets that drift out of phase with each other, get the subnets back in phase with the following steps:

1. Place a sleep support node in range of both subnets.
2. Select a node in the subnet that you want the other subnet to sync with.
3. Use this node to slightly change the sleep cycle settings of the network, for example, increment **ST**.
4. Wait for the subnet's next wake cycle. During this cycle, the node you select to change the sleep cycle parameters sends the new settings to the entire subnet it is in range of, including the sleep support node that is in range of the other subnet.
5. Wait for the out of sync subnet to wake up and send a sync. When the sleep support node receives this sync, it rejects it and sends a sync to the subnet with the new sleep settings.
6. The subnets will now be in sync. You can remove the sleep support node.
7. You can also change the sleep cycle settings back to the previous settings.

If you only need to replace a few nodes, you can use this method:

1. Reset the out of sync node and set its sleep mode to Synchronous Cyclic Sleep mode (**SM** = 8).
2. Set up a short sleep cycle.
3. Place the node in range of a sleep support node or wake a sleeping node with the Commissioning Pushbutton.
4. The out of sync node receives a sync from the node that is synchronized to the network. It then syncs to the network sleep settings.

## Diagnostics

The following diagnostics are useful in applications that manage a sleeping router network:

### Query sleep cycle

Use the **OS** and **OW** commands to query the current operational sleep and wake times that a device uses.

**Sleep status**

Use the **SS** command to query useful information regarding the sleep status of the device. Use this command to query if the node is currently acting as a network sleep coordinator.

**Missed sync messages command**

Use the **MS** command to query the number of cycles that elapsed since the device received a sync message.

**Sleep status API messages**

When you use the **SO** command to enable this option, a device that is in API operating mode outputs modem status frames immediately after it wakes up and prior to going to sleep.

## Advanced application features

---

Remote configuration commands .....	100
Network commissioning and diagnostics .....	100
I/O line monitoring .....	109
General Purpose Flash Memory .....	112
General Purpose Flash Memory commands .....	114
Over-the-air firmware updates .....	120

## Remote configuration commands

The API firmware has provisions to send configuration commands to remote devices using the Remote Command Request API frame (see [API operation](#)). Use the API frame to send commands to a remote device to read or set command parameters.

### Send a remote command

To send a remote command, populate the Remote Command Request frame with:

- 64-bit address of the remote device
- Correct command options value
- Command and parameter data (optional)

If you want a command response, set the Frame ID set to a non-zero value. Only unicasts of remote commands are supported, and remote commands cannot be broadcast.

### Apply changes on remote devices

When you use remote commands to change command parameter settings on a remote device, parameter changes do not take effect until you apply the changes. For example, changing the **BD** parameter does not change the serial interface on the remote until the changes are applied. To apply changes, do one of the following:

### Remote command responses

If the remote device receives a remote command request transmission, and the API frame ID is non-zero, the remote sends a remote command response transmission back to the device that sent the remote command. When a remote command response transmission is received, a device sends a remote command response API frame out its serial port. The remote command response indicates the status of the command (success, or reason for failure), and in the case of a command query, it includes the register value. The device that sends a remote command will not receive a remote command response frame if either of the following conditions exist:

- The destination device could not be reached.
- The frame ID in the remote command request is set to 0.

## Network commissioning and diagnostics

We call the process of discovering and configuring devices in a network for operation, "network commissioning." Devices include several device discovery and configuration features. In addition to configuring devices, you must develop a strategy to place devices to ensure reliable routes. To accommodate these requirements, modules include features to aid in placing devices, configuring devices, and network diagnostics.

### Configure devices

You can configure XBee devices locally through serial commands (AT or API) or remotely through remote API commands. API devices can send configuration commands to set or read the configuration settings of any device in the network.

## Network link establishment and maintenance

### Build aggregate routes

In many applications it is necessary for many or all of the nodes in the network to transmit data to a central aggregator node. In a new DigiMesh network the overhead of these nodes discovering routes to the aggregator node can be extensive and taxing on the network. To eliminate this overhead, use the **AG** command to automatically build routes to an aggregate node in a DigiMesh network.

### Send a unicast

To send a unicast, devices configured for Transparent mode (**AP = 0**) must set their **DH/DL** registers to the MAC address of the node which they need to transmit to. In networks of Transparent mode devices which transmit to an aggregator node, it is necessary to set every device's **DH/DL** registers to the MAC address of the aggregator node. Use the **AG** command to set the **DH/DL** registers of all the nodes in a DigiMesh network to that of the aggregator node.

### Use the AG command

Upon deploying a DigiMesh network, send the **AG** command on the desired aggregator node to cause all nodes in the network to build routes to the aggregator node. You can use the command to automatically update the **DH/DL** registers to match the MAC address of the aggregator node.

The **AG** command requires a 64-bit parameter. The parameter indicates the current value of the **DH/DL** registers on a device which should be replaced by the 64-bit address of the node sending the **AG** broadcast. If it is not desirable to update the **DH/DL** of the device receiving the **AG** broadcast, you can use the invalid address of 0xFFFE. API enabled devices output an [Aggregate Addressing Update frame - 0x8E](#) if they update their **DH/DL** address.

All devices that receive an **AG** broadcast update their routing table information to build a route to the sending device, regardless of whether or not their **DH/DL** address is updated. This routing information will be used for future transmissions of DigiMesh unicasts.

**Example 1:** To update the **DH/DL** registers of all modules in the network to be equal to the MAC address of an aggregator node with a MAC address of **0x0013a2004052c507** after network deployment the following technique could be employed:

1. Deploy all devices in the network with the default **DH/DL** of 0xFFFF.
2. Send an **ATAGFFFF** command on the aggregator node.

Following the preceding sequence would result in all of the nodes in the network which received the **AG** broadcast to have a **DH** of **0x0013a200** and a **DL** of **0x4052c507**. These nodes would have automatically built a route to the aggregator.

**Example 2:** To cause all nodes in the network to build routes to an aggregator node with a MAC address of **0x0013a2004052c507** without affecting the **DH/DL** of any nodes in the network, send the **AGFFFE** command on the aggregator node. This sends an **AG** broadcast to all nodes in the network.

All of the nodes will update their internal routing table information to contain a route to the aggregator node. None of the nodes update their **DH/DL** registers, because none of the registers are set to an address of **0xFFFE**.

### Node replacement

You can also use the **AG** command to update the routing table and **DH/DL** registers in the network after a device is replaced, and you can update the **DH/DL** registers of nodes in the network.

- To update only the routing table information without affecting the **DH/DL** registers, use Example 2.
- To update the **DH/DL** registers of the network, use the method in the following example.

**Example:** Use the device with serial number 0x0013a2004052c507 as a network aggregator and replace it with a device with serial number 0x0013a200f5e4d3b2. Issue the AG0013a2004052c507 command on the new module. This causes all devices with a **DH/DL** register setting of 0x0013a2004052c507 to update their **DH/DL** register setting to the MAC address of the sending device (0x0013a200f5e4d3b2).

## Place devices

For a network installation to be successful, installers must be able to determine where to place individual XBee devices to establish reliable links throughout the network.

### RSSI indicators

It is possible to measure the received signal strength on a device using the **DB** command. **DB** returns the RSSI value (measured in -dBm) of the last received packet. However, this number can be misleading in DigiMesh networks. The **DB** value only indicates the received signal strength of the last hop. If a transmission spans multiple hops, the **DB** value provides no indication of the overall transmission path, or the quality of the worst link; it only indicates the quality of the last link.

Determine the **DB** value in hardware using the RSSI/PWM device pin (pin 7). If you enable the RSSI PWM functionality (**PO** command), when the device receives data, it sets the RSSI PWM to a value based on the RSSI of the received packet (this value only indicates the quality of the last hop). You could connect this pin to an LED to indicate if the link is stable or not.

### Test links in a network - loopback cluster

To measure the performance of a network, you can send unicast data through the network from one device to another to determine the success rate of several transmissions. To simplify link testing, the devices support a Loopback cluster ID (0x12) on the data endpoint (0xE8). The cluster ID on the data endpoint sends any data transmitted to it back to the sender.

The following figure demonstrates how you can use the Loopback cluster ID and data endpoint to measure the link quality in a mesh network.

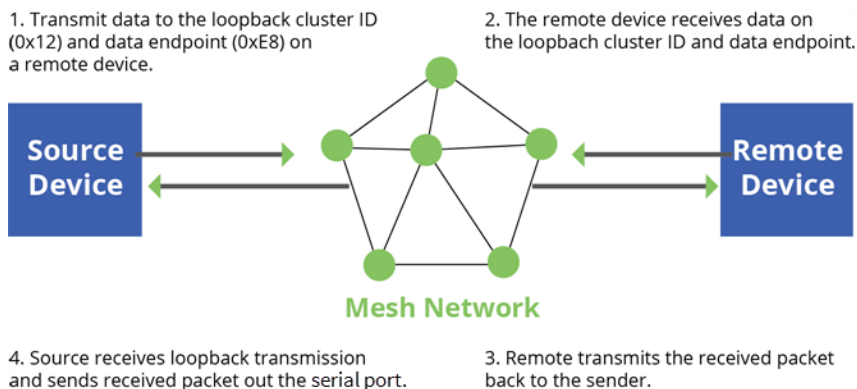

The configuration steps for sending data to the loopback cluster ID depend on what mode the device is in. For details on setting the mode, see [API Mode](#). The following sections list the steps based on the device's mode.

#### Transparent operating mode configuration (AP = 0)

To send data to the loopback cluster ID on the data endpoint of a remote device:

1. Set the **CI** command to **0x12**.
2. Set the **SE** and **DE** commands to **0xE8** (default value).

3. Set the **DH** and **DL** commands to the address of the remote (**0** for the coordinator, or the 64-bit address of the remote).

After exiting Command mode, the device transmits any serial characters it received to the remote device, which returns those characters to the sending device.

#### **API operating mode configuration (AP = 1 or AP = 2)**

Send an [Explicit Addressing Command frame - 0x11](#) using **0x12** as the cluster ID and **0xE8** as both the source and destination endpoint.

The remote device echoes back the data packets it receives to the sending device.

## Device discovery

### **Network discovery**

Use the network discovery command to discover all devices that have joined a network. Issuing the **ND** command sends a broadcast network discovery command throughout the network. All devices that receive the command send a response that includes:

- Device addressing information
- Node identifier string (see [NI command](#))
- Other relevant information

You can use this command for generating a list of all module addresses in a network.

### **Neighbor polling**

Use the neighbor poll command to discover the modules which are immediate neighbors (within RF range) of a particular node. You can use this command to determine network topology and determine possible routes.

The device sends the command using the **FN** command. You can initiate the **FN** command locally on a node using AT command mode or by using a local AT command request frame. You can also initiate the command remotely by sending the target node an **FN** command using a remote AT command request API frame.

A node that executes an **FN** command sends a broadcast to all of its immediate neighbors. All devices that receive this broadcast send an RF packet to the node that initiated the **FN** command. In an instance where the device initiates the command remotely, it sends the responses directly to the node which sent the **FN** command to the target node. The device outputs the response packet on the initiating radio in the same format as a network discovery frame.

## Link reliability

To install a successful mesh network, you must be able to determine where to place individual XBee devices to establish reliable links throughout the mesh network.

### **Network link testing**

To determine the success rate of many transmissions, send unicast data through the network from one device to another to measure the performance of the mesh network.

To simplify link testing, the modules support a loopback cluster ID (0x12) on the data endpoint (0xE8). The device transmits any data sent to this cluster ID on the data endpoint back to the sender as illustrated in the following figure:

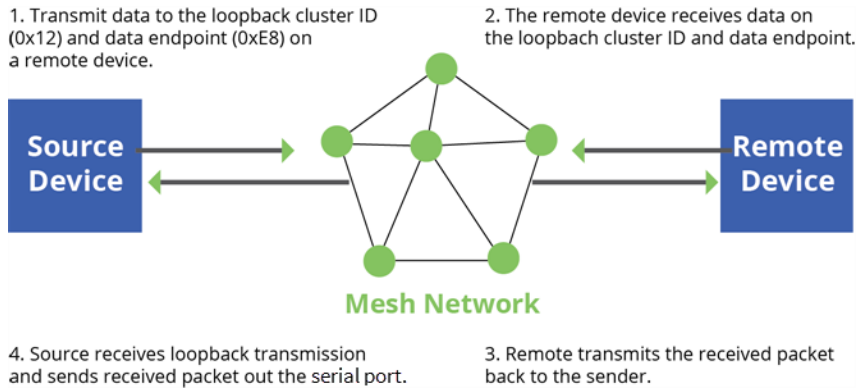

The configuration steps to send data to the loopback cluster ID depend on the AP setting.

**AT configuration (AP=0)**

To send data to the loopback cluster ID on the data endpoint of a remote device, set the **CI** command value to 0x12. Set the **SE** and **DE** commands set to 0xE8 (default value). Set the **DH** and **DL** commands to the address of the remote. After exiting command mode, the source device transmits any received serial characters to the remote device, and returned to the sender.

**API configuration (AP=1 or AP=2)**

Send an Explicit Addressing Command API frame (0x11) using 0x12 as the cluster ID and 0xE8 as the source and destination endpoint. The remote device echoes any data packets it receives to the sender.

**Link testing between adjacent devices**

To test the quality of a link between two adjacent nodes in a network, use the Test Link Request Cluster ID send a number of test packets between any two nodes in a network.

Initiate a link test using an Explicit TX Request frame. Address the command frame to the Test Link Request Cluster ID (0x0014) on destination endpoint 0xE6 on the device to execute the test link. The Explicit TX Request frame contains a 12 byte payload with the following format:

Number of bytes	Field name	Description
8	Destination address	The address the device tests its link with.
2	Payload size	The size of the test packet. Use the MP command to query the maximum payload size for this device.
2	Iterations	The number of packets to send. Use a number between 1 and 4000.

After completing the transmissions of the test link packets, the executing device sends the following data packet to the requesting device's Test Link Result Cluster (0x0094) on endpoint (0xE6). If the requesting device is operating in API mode, the device outputs the following information as an API Explicit RX Indicator Frame:



Number of bytes	Field name	Description
8	Destination address	The address where the device tested its link.
2	Payload size	The size of the test packet sent to test the link.
2	Iterations	The number of packets sent.
2	Success	The number of packets successfully acknowledged.
2	Retries	The total number of MAC retries to transfer all the packets.
1	Result	0x00 - command was successful. 0x03 - invalid parameter used.
1	RR	The maximum number of MAC retries allowed.
1	maxRSSI	The strongest RSSI reading observed during the test.
1	minRSSI	The weakest RSSI reading observed during the test.
1	avgRSSI	The average RSSI reading observed during the test.

**Example**

Suppose that the link between device A (**SH/SL** = 0x0013a20040521234) and device B (**SH/SL**=0x0013a2004052abcd) is being tested by transmitting 1,000 40 byte packets. Send the following API packet to the serial interface of the device outputting the results, device C. Note that device C can be the same device as device A or B (Whitespace delineates fields and bold text is the payload portion of the packet):

```
7E 0020 11 01 0013A20040521234 FFFE E6 E6 0014 C105 00 00 0013A2004052ABCD 0028 03E8 EB
```

And the following is a possible packet returned:

```
7E 0027 91 0013A20040521234 FFFE E6 E6 0094 C105 00 0013A2004052ABCD 0028 03E8 03E7 0064 00 0A 50 53 52 9F
```

(999 out of 1000 packets successful, 100 retries used, RR=10, maxRSSI= - 80 dBm, minRSSI= - 83 dBm, avgRSSI= - 82 dBm)

If the result field is not equal to zero then an error occurred. Ignore the other fields in the packet. If the Success field is equal to zero then ignore the RSSI fields.

**Trace routing**

Determining the route a DigiMesh unicast takes to its destination is useful when setting up a network or diagnosing problems within a network. Use the Trace Route API option of Tx Request Packets to transmit routing information packets to the originator of a DigiMesh unicast by the intermediate nodes. For a description of the API frames, see [API operating mode](#).

When a unicast is sent with the Trace Route API option enabled, the unicast is sent to its destination radios which forward the unicast to its eventual destination and transmit a Route Information (RI) packet back along the route to the unicast originator. For more information, see [API operating mode](#).

**Example:**

Suppose you unicast a data packet with the trace route enabled from radio A to radio E, through radios B, C, and D. The following sequence occurs:

- After the successful MAC transmission of the data packet from A to B, A outputs an RI Packet indicating that the transmission of the data packet from A to E was successfully forwarded one hop from A to B.
- After the successful MAC transmission of the data packet from B to C, B transmits a RI Packet to A. Then, A outputs this RI packet out its serial interface.
- After the successful MAC transmission of the data packet from C to D, C transmits a RI Packet to A (through B). Then, A outputs this RI packet out its serial interface.
- After the successful MAC transmission of the data packet from D to E, D transmits an RI Packet to A (through C and B). Then, A outputs this RI packet out its serial interface.

Route Information packets are not guaranteed to arrive in the same order as the unicast packet took. It is also possible Route Information packets that are transferred on a weak route to fail before arriving at the unicast originator.

Because of the large number of Route Information packets that can be generated by a unicast with Trace Route enabled, we suggest that the Trace Route option only be used for occasional diagnostic purposes and not for normal operations.

### **NACK messages**

Transmit Request (0x10 and 0x11) frames contain a negative-acknowledge character (NACK) API option (Bit 2 of the Transmit Options field).

If you use this option when transmitting data, when a MAC acknowledgment failure occurs on one of the hops to the destination device, the device generates a Route Information Packet (0x8D) frame and sends it to the originator of the unicast.

This information is useful because it allows you to identify and repair marginal links.

### **Commissioning pushbutton and associate LED**

XBee devices support a set of commissioning pushbutton and LED behaviors to aid in device deployment and commissioning. These include the commissioning push button definitions and associate LED behaviors. The following features can be supported in hardware:

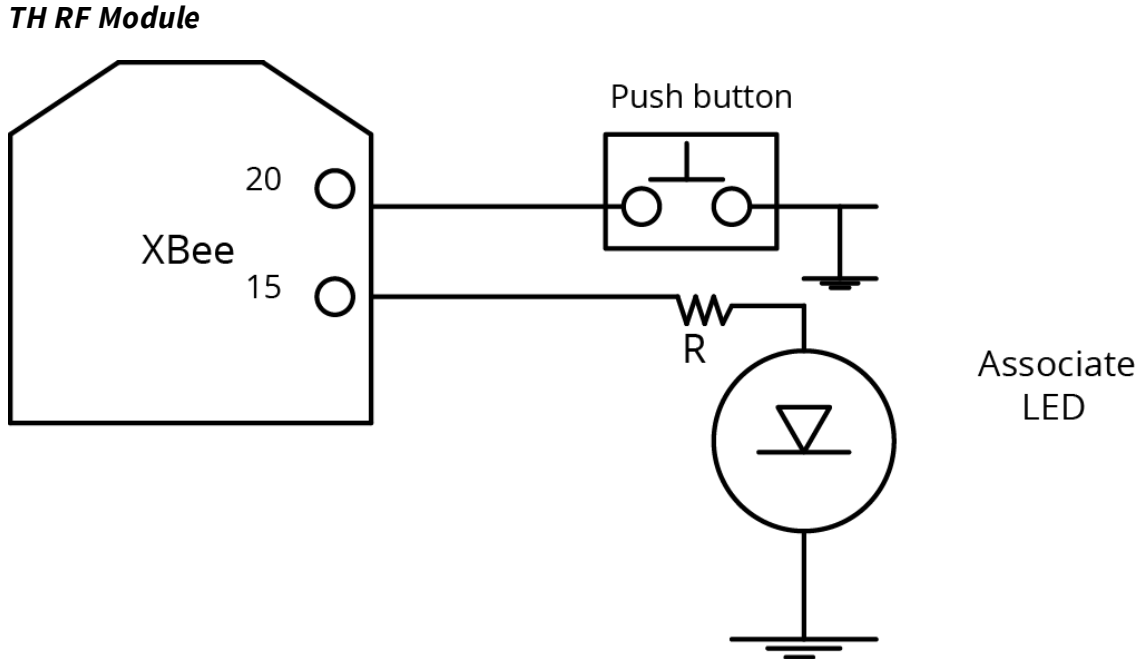

A pushbutton and an LED can be connected to the XBee 868LP RF Module pins 33 and 28 (SMT), or pins 20 and 15 (TH) respectively to support the commissioning pushbutton and associate LED functionalities.

### Commissioning pushbutton

The commissioning pushbutton definitions provide a variety of simple functions to help with deploying devices in a network. Enable the commissioning button functionality on pin 20 by setting the **DO** command to 1 (enabled by default).

Button Presses	Sleep configuration and sync status	Action
1	Not configured for sleep	Immediately sends a Node Identification broadcast transmission. All devices that receive this transmission blink their Associate LED rapidly for 1 second. All API devices that receive this transmission send a Node Identification frame out their serial interface (API ID 0x95).
1	Configured for synchronous sleep	Wakes the module for 30 seconds. Immediately sends a Node Identification broadcast transmission. All devices that receive this transmission blink their Associate LED rapidly for 1 second. All API devices that receive this transmission send a Node Identification frame out their serial interface (API ID 0x95).

Button Presses	Sleep configuration and sync status	Action
1	Configured for synchronous sleep	Wakes the module for 30 seconds (or until the synchronized network goes to sleep). Queues a Node Identification broadcast transmission sent at the beginning of the next network wake cycle. All devices receiving this transmission blink their Associate LEDs rapidly for 1 second. All API devices that receive this transmission will send a Node Identification frame out their serial interface (API ID 0x95).
2	Not configured for synchronous sleep	No effect.
2	Configured for synchronous sleep	Causes a node configured with sleeping router nomination enabled (see the <b>SO</b> command in <a href="#">Sleep modes</a> to immediately nominate itself as the network sleep coordinator.
4	Any	Issues an ATRE to restore module parameters to default values.

Use the **CB** command to simulate button presses in the software. Issue a **CB** command with a parameter set to the number of button presses you want execute. For example, sending **CB1** executes the actions associated with a single button press.

The node identification frame is similar to the node discovery response frame; it contains the device’s address, node identifier string (**NI** command), and other relevant data. All API devices that receive the node identification frame send it out their serial interface as an API Node Identification Indicator frame (0x95).

### Associate LED

The Associate pin (pin 15) provides an indication of the device's sleep status and diagnostic information. To take advantage of these indications, connect an LED to the Associate pin.

To enable the Associate LED functionality, set the **D5** command to 1; it is enabled by default. If enabled, the Associate pin is configured as an output. This section describes the behavior of the pin.

Use the **LT** command to override the blink rate of the Associate pin. If you set **LT** to 0, the device uses the default blink time: 500 ms for a sleep coordinator, 250 ms otherwise.

The following table describes the Associate LED functionality.

Sleep mode	LED status	Meaning
0	On, blinking	The device has power and is operating properly
1, 4, 5	Off	The device is in a low power mode
1, 4, 5	On, blinking	The device has power, is awake and is operating properly

Sleep mode	LED status	Meaning
7	On, solid	The network is asleep, or the device has not synchronized with the network, or has lost synchronization with the network
7, 8	On, slow blinking (500 ms blink time)	The device is acting as the network sleep coordinator and is operating properly
7, 8	On, fast blinking (250 ms blink time)	The device is properly synchronized with the network
8	Off	The device is in a low power mode
8	On, solid	The device has not synchronized or has lost synchronization with the network

### Diagnostics support

The Associate pin works with the Commissioning Pushbutton to provide additional diagnostic behaviors to aid in deploying and testing a network. If you press the Commissioning Pushbutton once, the device transmits a broadcast Node Identification Indicator (0x95) frame at the beginning of the next wake cycle if the device is sleep compatible, or immediately if the device is not sleep compatible. If you enable the Associate LED functionality using the **D5** command, a device that receives this transmission blinks its Associate pin rapidly for one second.

## I/O line monitoring

### I/O samples

The XBee 868LP RF Module supports both analog input and digital I/O line modes on several configurable pins.

### Queried sampling

Pin configuration commands include the following parameters:

Pin command parameter	Description
0	Unmonitored digital input
1	Reserved for pin-specific alternate functionality
2	Analog input (A/D pins) or PWM output (PWM pins)
3	Digital input, monitored
4	Digital output, low
5	Digital output, high
7	Alternate functionality, where applicable

The following table provides the pin configurations when you set the configuration command for a particular pin.

Device pin name	Device pin number	Configuration command
CD / DIO12	4	<b>P2</b>
PWM0 / RSSI / DIO10	6	<b>P0</b>
PWM1 / DIO11	7	<b>P1</b>
$\overline{\text{DTR}}$ / SLEEP_RQ / DIO8	9	<b>D8</b>
AD4 / DIO4	11	<b>D4</b>
$\overline{\text{CTS}}$ / DIO7	12	<b>D7</b>
ON/ $\overline{\text{SLEEP}}$ / DIO9	13	<b>D9</b>
ASSOC / AD5 / DIO5	15	<b>D5</b>
$\overline{\text{RTS}}$ / DIO6	16	<b>D6</b>
AD3 / DIO3	17	<b>D3</b>
AD2 / DIO2	18	<b>D2</b>
AD1 / DIO1	19	<b>D1</b>
AD0 / DIO0 / Commissioning Pushbutton	20	<b>D0</b>

Use the **PR** command to enable internal pull up/down resistors for each digital input. Use the **PD** command to determine the direction of the internal pull up/down resistor.

Field	Name	Description
1	Sample sets	Number of sample sets in the packet. Always set to 1.
2	Digital channel mask	<p>Indicates which digital I/O lines have sampling enabled. Each bit corresponds to one digital I/O line on the device.</p> <ul style="list-style-type: none"> <li>bit 0 = AD0/DIO0</li> <li>bit 1 = AD1/DIO1</li> <li>bit 2 = AD2/DIO2</li> <li>bit 3 = AD3/DIO3</li> <li>bit 4 = DIO4</li> <li>bit 5 = ASSOC/DIO5</li> <li>bit 6 = RTS/DIO6</li> <li>bit 7 = CTS/GPIO7</li> <li>bit 8 = DTR / SLEEP_RQ / DIO8</li> <li>bit 9 = ON_SLEEP / DIO9</li> <li>bit 10 = RSSI/DIO10</li> <li>bit 11 = PWM/DIO11</li> <li>bit 12 = CD/DIO12</li> </ul> <p>For example, a digital channel mask of 0x002F means DIO0,1,2,3, and 5 are enabled as digital I/O.</p>

Field	Name	Description
1	Analog channel mask	Indicates which lines have analog inputs enabled for sampling. Each bit in the analog channel mask corresponds to one analog input channel.  bit 0 = AD0/DIO0 bit 1 = AD1/DIO1 bit 2 = AD2/DIO2 bit 3 = AD3/DIO3 bit 4 = AD4/DIO4 bit 5 = ASSOC/AD5/DIO5
Variable	Sampled data set	If you enable any digital I/O lines, the first two bytes of the data set indicate the state of all enabled digital I/O. Only digital channels that you enable in the Digital channel mask bytes have any meaning in the sample set. If do not enable any digital I/O on the device, it omits these two bytes. Following the digital I/O data (if there is any), each enabled analog channel returns two bytes. The data starts with AIN0 and continues sequentially for each enabled analog input channel up to AIN5.

If you issue the **IS** command using an Command mode, the device returns a carriage return delimited list containing the fields in the previous list. If you issue a command via an API frame, the device returns an AT command response API frame with the I/O data included in the command data portion of the packet.

Example	Sample AT response
0x01	[1 sample set]
0x0C0C	[Digital Inputs: DIO 2, 3, 10, 11 enabled]
0x03	[Analog Inputs: A/D 0, 1 enabled]
0x0408	[Digital input states: DIO 3, 10 high, DIO 2, 11 low]
0x03D0	[Analog input: ADIO 0 = 0x3D0]
0x0124	[Analog input: ADIO 1 =0x120]

### Periodic I/O sampling

Periodic sampling allows a device to take an I/O sample and transmit it to a remote device at a periodic rate. Use the **IR** command to set the periodic sample rate.

- To disable periodic sampling, set **IR** to **0**.
- For all other **IR** values, the firmware samples data when **IR** milliseconds elapse and the sample data transmits to a remote device.

The **DH** and **DL** commands determine the destination address of the I/O samples.

Only devices with API operating mode enabled send I/O data samples out their serial interface. Devices that are in Transparent mode (**AP** = **0**) discard the I/O data samples they receive.

A device with sleep enabled transmits periodic I/O samples at the **IR** rate until the **ST** time expires and the device can resume sleeping. For more information about setting sleep modes, see [Sleep modes](#).

### Detect digital I/O changes

You can configure devices to transmit a data sample immediately whenever a monitored digital I/O pin changes state. The **IC** command is a bitmask that you use to set which digital I/O lines to monitor for a state change. If you set one or more bits in **IC**, the device transmits an I/O sample as soon it observes a state change in one of the monitored digital I/O lines using edge detection.

The figure below shows how I/O change detection can work with periodic sampling.

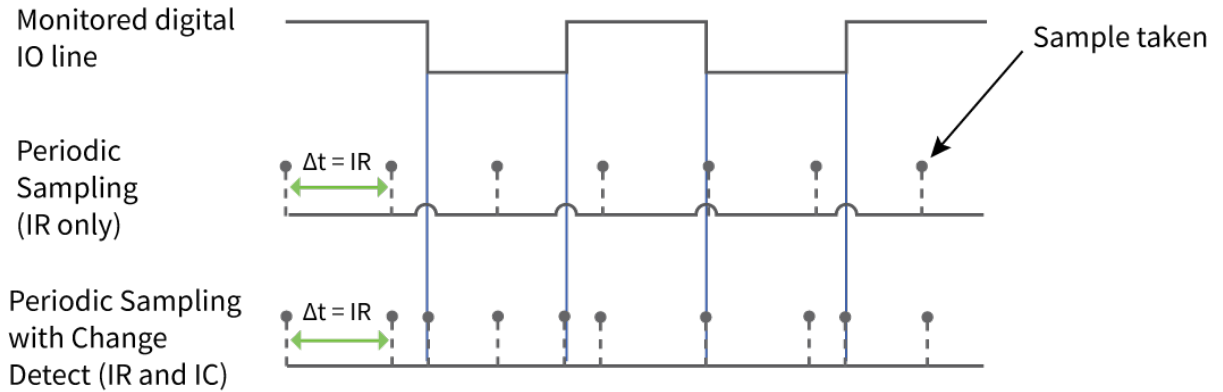

Enabling edge detection forces an immediate sample of all monitored digital I/O lines if any digital I/O lines change state.

## General Purpose Flash Memory

XBee 868LP RF Modules provide 119 512-byte blocks of flash memory that an application can read and write to. This memory provides a non-volatile data storage area that an application uses for many purposes. Some common uses of this data storage include:

- Storing logged sensor data
- Buffering firmware update data for a host microcontroller
- Storing and retrieving data tables needed for calculations performed by a host microcontroller

The General Purpose Memory (GPM) is also used to store a firmware update file for over-the-air firmware updates of the device itself.

### Access General Purpose Flash Memory

To access the GPM of a target node locally or over-the-air, send commands to the MEMORY\_ACCESS cluster ID (0x23) on the DIGI\_DEVICE endpoint (0xE6) of the target node using explicit API frames. For a description of Explicit API frames, see [Operate in API mode](#).

To issue a GPM command, format the payload of an explicit API frame as follows:

Byte offset in payload	Number of bytes	Field name	General field description
0	1	GPM_CMD_ID	Specific GPM commands are described in detail in the topics that follow.
1	1	GPM_OPTIONS	Command-specific options.



Byte offset in payload	Number of bytes	Field name	General field description
2	2*	GPM_BLOCK_NUM	The block number addressed in the GPM.
4	2*	GPM_START_INDEX	The byte index within the addressed GPM block.
6	2*	GPM_NUM_BYTES	The number of bytes in the GPM_DATA field, or in the case of a READ, the number of bytes requested.
8	varies	GPM_DATA	
* Specify multi-byte parameters with big-endian byte ordering.			

When a device sends a GPM command to another device via a unicast, the receiving device sends a unicast response back to the requesting device's source endpoint specified in the request packet. It does not send a response for broadcast requests. If the source endpoint is set to the DIGI\_DEVICE endpoint (0xE6) or Explicit API mode is enabled on the requesting device, then the requesting node outputs a GPM response as an explicit API RX indicator frame (assuming it has API mode enabled). The format of the response is similar to the request packet:

Byte offset in payload	Number of bytes	Field name	General field description
0	1	GPM_CMD_ID	This field is the same as the request field.
1	1	GPM_STATUS	Status indicating whether the command was successful.
2	2*	GPM_BLOCK_NUM	The block number addressed in the GPM.
4	2*	GPM_START_INDEX	The byte index within the addressed GPM block.
6	2*	GPM_NUM_BYTES	The number of bytes in the GPM_DATA field.
8	varies	GPM_DATA	
* Specify multi-byte parameters with big-endian byte ordering.			

### Work with flash memory

When working with the General Purpose Memory, observe the following limitations:

- Flash memory write operations are only capable of changing binary 1s to binary 0s. Only the erase operation can change binary 0s to binary 1s. For this reason, you should erase a flash block before performing a write operation.
- When performing an erase operation, you must erase the entire flash memory block—you cannot erase parts of a flash memory block.

- Flash memory has a limited lifetime. The flash memory on which the GPM is based is rated at 20,000 erase cycles before failure. Take care to ensure that the frequency of erase/write operations allows for the desired product lifetime. Digi's warranty does not cover products that have exceeded the allowed number of erase cycles.
- Over-the-air firmware upgrades erase the entire GPM. Any user data stored in the GPM will be lost during an over-the-air upgrade.

## General Purpose Flash Memory commands

This section provides information about commands that interact with GPM:

### PLATFORM\_INFO\_REQUEST (0x00)

A PLATFORM\_INFO\_REQUEST frame can be sent to query details of the GPM structure.

Field name	Command-specific description
GPM_CMD_ID	Should be set to PLATFORM_INFO_REQUEST (0x00).
GPM_OPTIONS	This field is unused for this command. Set to 0.
GPM_BLOCK_NUM	This field is unused for this command. Set to 0.
GPM_START_INDEX	This field is unused for this command. Set to 0.
GPM_NUM_BYTES	This field is unused for this command. Set to 0.
GPM_DATA	No data bytes should be specified for this command.

### PLATFORM\_INFO (0x80)

When a PLATFORM\_INFO\_REQUEST command request has been unicast to a node, that node sends a response in the following format to the source endpoint specified in the requesting frame.

Field name	Command-specific description
GPM_CMD_ID	Should be set to PLATFORM_INFO (0x80).
GPM_STATUS	A 1 in the least significant bit indicates an error occurred. All other bits are reserved at this time.
GPM_BLOCK_NUM	Indicates the number of GPM blocks available.
GPM_START_INDEX	Indicates the size, in bytes, of a GPM block.
GPM_NUM_BYTES	The number of bytes in the GPM_DATA field. For this command, this field will be set to 0.
GPM_DATA	No data bytes are specified for this command.

#### Example

A PLATFORM\_INFO\_REQUEST sent to a device with a serial number of 0x0013a200407402AC should be formatted as follows (spaces added to delineate fields):

```
7E 001C 11 01 0013A200407402AC FFFE E6 E6 0023 C105 00 00 00 00 0000 0000 0000 24
```

Assuming all transmissions were successful, the following API packets would be output the source node's serial interface:

```
7E 0007 8B 01 FFFE 00 00 00 76
```

```
7E 001A 91 0013A200407402AC FFFE E6 E6 0023 C105 C1 80 00 0077 0200 0000 EB
```

## ERASE (0x01)

The ERASE command erases (writes all bits to binary 1) one or all of the GPM flash blocks. You can also use the ERASE command to erase all blocks of the GPM by setting the GPM\_NUM\_BYTES field to 0.

Field name	Command-specific description
GPM_CMD_ID	Should be set to ERASE (0x01).
GPM_OPTIONS	There are currently no options defined for the ERASE command. Set this field to 0.
GPM_BLOCK_NUM	Set to the index of the GPM block that should be erased. When erasing all GPM blocks, this field is ignored (set to 0).
GPM_START_INDEX	The ERASE command only works on complete GPM blocks. The command cannot be used to erase part of a GPM block. For this reason GPM_START_INDEX is unused (set to 0).
GPM_NUM_BYTES	Setting GPM_NUM_BYTES to 0 has a special meaning. It indicates that every flash block in the GPM should be erased (not just the one specified with GPM_BLOCK_NUM). In all other cases, the GPM_NUM_BYTES field should be set to the GPM flash block size.
GPM_DATA	No data bytes are specified for this command.

## ERASE\_RESPONSE (0x81)

When an ERASE command request has been unicast to a node, that node sends a response in the following format to the source endpoint specified in the requesting frame.

Field name	Command-specific description
GPM_CMD_ID	Should be set to ERASE_RESPONSE (0x81).
GPM_STATUS	A 1 in the least significant bit indicates an error occurred. All other bits are reserved at this time.
GPM_BLOCK_NUM	Matches the parameter passed in the request frame.
GPM_START_INDEX	Matches the parameter passed in the request frame.
GPM_NUM_BYTES	The number of bytes in the GPM_DATA field. For this command, this field will be set to 0.
GPM_DATA	No data bytes are specified for this command.

**Example**

To erase flash block 42 of a target radio with serial number of 0x0013a200407402ac format an ERASE packet as follows (spaces added to delineate fields):

```
7E 001C 11 01 0013A200407402AC FFFE E6 E6 0023 C105 00 C0 01 00 002A 0000 0200 37
```

Assuming all transmissions were successful, the following API packets would be output the source node's serial interface:

```
7E 0007 8B 01 FFFE 00 00 00 76
```

```
7E 001A 91 0013A200407402AC FFFE E6 E6 0023 C105 C1 81 00 002A 0000 0000 39
```

**WRITE (0x02) and ERASE\_THEN\_WRITE (0x03)**

The WRITE command writes the specified bytes to the GPM location specified. Before writing bytes to a GPM block it is important that the bytes have been erased previously. The ERASE\_THEN\_WRITE command performs an ERASE of the entire GPM block specified with the GPM\_BLOCK\_NUM field prior to doing a WRITE.

Field name	Command-specific description
GPM_CMD_ID	Should be set to WRITE (0x02) or ERASE_THEN_WRITE (0x03).
GPM_OPTIONS	There are currently no options defined for this command. Set this field to 0.
GPM_BLOCK_NUM	Set to the index of the GPM block that should be written.
GPM_START_INDEX	Set to the byte index within the GPM block where the given data should be written.
GPM_NUM_BYTES	Set to the number of bytes specified in the GPM_DATA field. Only one GPM block can be operated on per command. For this reason, GPM_START_INDEX + GPM_NUM_BYTES cannot be greater than the GPM block size. The number of bytes sent in an explicit API frame (including the GPM command fields) cannot exceed the maximum payload size of the device. The maximum payload size can be queried with the <b>NP</b> command.
GPM_DATA	The data to be written.

**WRITE\_RESPONSE (0x82) and ERASE\_THEN\_WRITE\_RESPONSE (0x83)**

When a WRITE or ERASE\_THEN\_WRITE command request has been unicast to a node, that node sends a response in the following format to the source endpoint specified in the requesting frame.

Field name	Command-specific description
GPM_CMD_ID	Should be set to WRITE_RESPONSE (0x82) or ERASE_THEN_WRITE_RESPONSE (0x83)

Field name	Command-specific description
GPM_STATUS	A 1 in the least significant bit indicates an error occurred. All other bits are reserved at this time
GPM_BLOCK_NUM	Matches the parameter passed in the request frame
GPM_START_INDEX	Matches the parameter passed in the request frame
GPM_NUM_BYTES	The number of bytes in the GPM_DATA field. For this command, this field will be set to 0
GPM_DATA	No data bytes are specified for these commands

**Example**

To write 15 bytes of incrementing data to flash block 22 of a target radio with serial number of 0x0013a200407402ac a WRITE packet should be formatted as follows (spaces added to delineate fields):

```
7E 002B 11 01 0013A200407402AC FFFE E6 E6 0023 C105 00 C0 02 00 0016 0000 000F
0102030405060708090A0B0C0D0E0F C5
```

Assuming all transmissions were successful and that flash block 22 was previously erased, the following API packets would be output the source node's serial interface:

```
7E 0007 8B 01 FFFE 00 00 00 76
7E 001A 91 0013A200407402AC FFFE E6 E6 0023 C105 C1 82 00 0016 0000 0000 4C
```

**READ (0x04)**

You can use the READ command to read the specified number of bytes from the GPM location specified. Data can be queried from only one GPM block per command.

Field name	Command-specific description
GPM_CMD_ID	Should be set to READ (0x04).
GPM_OPTIONS	There are currently no options defined for this command. Set this field to 0.
GPM_BLOCK_NUM	Set to the index of the GPM block that should be read.
GPM_START_INDEX	Set to the byte index within the GPM block where the given data should be read.
GPM_NUM_BYTES	Set to the number of data bytes to be read. Only one GPM block can be operated on per command. For this reason, GPM_START_INDEX + GPM_NUM_BYTES cannot be greater than the GPM block size. The number of bytes sent in an explicit API frame (including the GPM command fields) cannot exceed the maximum payload size of the device. You can query the maximum payload size with the <b>NP AT</b> command.
GPM_DATA	No data bytes should be specified for this command.

## READ\_RESPONSE (0x84)

When a READ command request has been unicast to a node, that node sends a response in the following format to the source endpoint specified in the requesting frame.

Field name	Command-specific description
GPM_CMD_ID	Should be set to READ_RESPONSE (0x84).
GPM_STATUS	A 1 in the least significant bit indicates an error occurred. All other bits are reserved at this time.
GPM_BLOCK_NUM	Matches the parameter passed in the request frame.
GPM_START_INDEX	Matches the parameter passed in the request frame.
GPM_NUM_BYTES	The number of bytes in the GPM_DATA field.
GPM_DATA	The bytes read from the GPM block specified.

### Example

To read 15 bytes of previously written data from flash block 22 of a target radio with serial number of 0x0013a200407402ac a READ packet should be formatted as follows (spaces added to delineate fields):

```
7E 001C 11 01 0013A200407402AC FFFE E6 E6 0023 C105 00 C0 04 00 0016 0000 000F 3B
```

Assuming all transmissions were successful and that flash block 22 was previously written with incrementing data, the following API packets would be output the source node's serial interface:

```
7E 0007 8B 01 FFFE 00 00 00 76
```

```
7E 0029 91 0013A200407402AC FFFE E6 E6 0023 C105 C1 84 00 0016 0000 000F
0102030405060708090A0B0C0D0E0F C3
```

## FIRMWARE\_VERIFY (0x05) and FIRMWARE\_VERIFY\_AND\_INSTALL (0x06)

Use the FIRMWARE\_VERIFY and FIRMWARE\_VERIFY\_AND\_INSTALL commands when remotely updating firmware on a device. For more information about firmware updates. These commands check if the GPM contains a valid over-the-air update file. For the FIRMWARE\_VERIFY\_AND\_INSTALL command, if the GPM contains a valid firmware image then the device resets and begins using the new firmware.

Field name	Command-specific description
GPM_CMD_ID	Should be set to FIRMWARE_VERIFY (0x05) or FIRMWARE_VERIFY_AND_INSTALL (0x06)
GPM_OPTIONS	There are currently no options defined for this command. Set this field to 0.
GPM_BLOCK_NUM	This field is unused for this command. Set to 0.
GPM_START_INDEX	This field is unused for this command. Set to 0.

Field name	Command-specific description
GPM_NUM_BYTES	This field is unused for this command. Set to 0.
GPM_DATA	This field is unused for this command

### **FIRMWARE\_VERIFY\_RESPONSE (0x85)**

When a FIRMWARE\_VERIFY command request has been unicast to a node, that node sends a response in the following format to the source endpoint specified in the requesting frame.

Field name	Command-specific description
GPM_CMD_ID	Should be set to FIRMWARE_VERIFY_RESPONSE (0x85)
GPM_STATUS	A 1 in the least significant bit indicates the GPM does not contain a valid firmware image. A 0 in the least significant bit indicates the GPM does contain a valid firmware image. All other bits are reserved at this time.
GPM_BLOCK_NUM	This field is unused for this command. Set to 0.
GPM_START_INDEX	This field is unused for this command. Set to 0.
GPM_NUM_BYTES	This field is unused for this command. Set to 0.
GPM_DATA	This field is unused for this command

### **FIRMWARE\_VERIFY\_AND\_INSTALL\_RESPONSE (0x86)**

When a FIRMWARE\_VERIFY\_AND\_INSTALL command request has been unicast to a node, that node sends a response in the following format to the source endpoint specified in the requesting frame only if the GPM memory does not contain a valid image. If the image is valid, the device resets and begins using the new firmware.

Field name	Command-specific description
GPM_CMD_ID	Should be set to FIRMWARE_VERIFY_AND_INSTALL_RESPONSE (0x86).
GPM_STATUS	A 1 in the least significant bit indicates the GPM does not contain a valid firmware image. All other bits are reserved at this time.
GPM_BLOCK_NUM	This field is unused for this command. Set to 0.
GPM_START_INDEX	This field is unused for this command. Set to 0.
GPM_NUM_BYTES	This field is unused for this command. Set to 0.
GPM_DATA	This field is unused for this command.

#### **Example**

To verify a firmware image previously loaded into the GPM on a target device with serial number 0x0013a200407402ac, format a FIRMWARE\_VERIFY packet as follows (spaces added to delineate fields):

```
7E 001C 11 01 0013A200407402AC FFFE E6 E6 0023 C105 00 00 05 00 0000 0000 0000 1F
```

Assuming all transmissions were successful and that the firmware image previously loaded into the GPM is valid, the following API packets would be output the source node's serial interface:

```
7E 0007 8B 01 FFFE 00 00 00 76
```

```
7E 001A 91 0013A200407402AC FFFE E6 E6 0023 C105 C1 85 00 0000 0000 0000 5F
```

## Over-the-air firmware updates

There are two methods of updating the firmware on the device. You can update the firmware locally with XCTU using the device's serial port interface. You can also update firmware using the device's RF interface (over-the-air updating.)

The over-the-air firmware update method provided is a robust and versatile technique that you can tailor to many different networks and applications. OTA updates are reliable and minimize disruption of normal network operations.

In the following sections, we refer to the node that will be updated as the target node. We refer to the node providing the update information as the source node. In most applications the source node is locally attached to a computer running update software.

There are three phases of the over-the-air update process:

1. [Distribute the new application](#)
2. [Verify the new application](#)
3. [Install the application](#)

### Distribute the new application

The first phase of performing an over-the-air update on a device is transferring the new firmware file to the target node. Load the new firmware image in the target node's GPM prior to installation. XBee 868LP RF Modules use an encrypted binary (.ebin) file for both serial and over-the-air firmware updates. These firmware files are available on the [Digi Support website](#) and via XCTU.

Send the contents of the .ebin file to the target device using general purpose memory WRITE commands. Erase the entire GPM prior to beginning an upload of an .ebin file. The contents of the .ebin file should be stored in order in the appropriate GPM memory blocks. The number of bytes that are sent in an individual GPM WRITE frame is flexible and can be catered to the user application.

#### Example

The example firmware version has an .ebin file of 55,141 bytes in length. Based on network traffic, we determine that sending a 128 byte packet every 30 seconds minimizes network disruption. For this reason, you would divide and address the .ebin as follows:

GPM_BLOCK_NUM	GPM_START_INDEX	GPM_NUM_BYTES	.ebin bytes
0	0	128	0 to 127
0	128	128	128 to 255
0	256	128	256 to 383
0	384	128	384 to 511



GPM_BLOCK_NUM	GPM_START_INDEX	GPM_NUM_BYTES	.ebin bytes
1	0	128	512 to 639
1	128	128	640 to 767
-	-	-	-
-	-	-	-
-	-	-	-
107	0		54784 to 54911
107	128		54912 to 55039
107	256	101	55040 to 55140

## Verify the new application

For an uploaded application to function correctly, every single byte from the .ebin file must be properly transferred to the GPM. To guarantee that this is the case, GPM VERIFY functions exist to ensure that all bytes are properly in place. The FIRMWARE\_VERIFY function reports whether or not the uploaded data is valid. The FIRMWARE\_VERIFY\_AND\_INSTALL command reports if the uploaded data is invalid. If the data is valid, it begins installing the application. No installation takes place on invalid data.

## Install the application

When the entire .ebin file is uploaded to the GPM of the target node, you can issue a FIRMWARE\_VERIFY\_AND\_INSTALL command. Once the target receives the command it verifies the .ebin file loaded in the GPM. If it is valid, then the device installs the new firmware. This installation process can take up to eight seconds. During the installation the device is unresponsive to both serial and RF communication. To complete the installation, the target module resets. AT parameter settings which have not been written to flash using the **WR** command will be lost.

### **Important considerations**

The firmware upgrade process requires that the device resets itself. Write all parameters with the **WR** command before performing a firmware update. Packet routing information is also lost after a reset. Route discoveries are necessary for DigiMesh unicasts involving the updated node as a source, destination, or intermediate node.

Because explicit API Tx frames can be addressed to a local node (accessible via the SPI or UART) or a remote node (accessible over the RF port) the same process can be used to update firmware on a device in either case.

## Networking methods

---

This section explains the basic layers and the three networking methods available on the XBee 868LP RF Modules, building from the simplest to the most complex.

Directed Broadcast/Repeater mode .....	123
Point to Point/Multipoint mode .....	123
DigiMesh networking .....	123
Networking concepts .....	125
Data transmission and routing .....	125

## Directed Broadcast/Repeater mode

In this broadcast mode, the exact transmission method is determined by the data rate of your device.

- In the 10k version, set the network in a repeater mode, where there is no route discovery. The transmission is sent out to the network and each device repeats the message to its neighboring devices. There is no route discovery in this method.
- In the 80k version of the device, the transmission is directed to a specific media access control (MAC) address, using a route discovered by a router device. In both methods, all transmissions are broadcast messages, not unicast messages.

## Point to Point/Multipoint mode

In this mode, there is a permanent link between two endpoints. Switched point-to-point topologies are the basic model of conventional telephony. The value of a permanent point-to-point network is unimpeded communications between the two endpoints. The value of an on-demand point-to-point connection is proportional to the number of potential pairs of subscribers.

### Permanent (dedicated)

One of the variations of point-to-point topology is a point-to-point communications channel that appears, to the user, to be permanently associated with the two endpoints. Within many switched telecommunications systems, it is possible to establish a permanent circuit. One example might be a telephone in the lobby of a public building that is programmed to ring only the number of a telephone dispatcher. “Nailing down” a switched connection saves the cost of running a physical circuit between the two points. The resources in such a connection can be released when it is no longer needed.

### Switched

Using circuit-switching or packet-switching technologies, you can set up a point-to-point circuit dynamically and dropped when no longer needed.

## DigiMesh networking

A mesh network is a topology in which each node in the network is connected to other nodes around it. Each node cooperates in transmitting information. Mesh networking provides these important benefits:

- **Routing.** With this technique, the message is propagated along a path by hopping from node to node until it reaches its final destination.
- **Ad-hoc network creation.** This is an automated process that creates an entire network of nodes on the fly, without any human intervention.
- **Self-healing.** This process automatically figures out if one or more nodes on the network is missing and reconfigures the network to repair any broken routes.
- **Peer-to-peer architecture.** No hierarchy and no parent-child relationships are needed.
- **Quiet protocol.** Routing overhead will be reduced by using a reactive protocol similar to AODV.
- **Route discovery.** Rather than maintaining a network map, routes will be discovered and created only when needed.

- **Selective acknowledgments.** Only the destination node will reply to route requests.
- **Reliable delivery.** Reliable delivery of data is accomplished by means of acknowledgments.
- **Sleep modes.** Low power sleep modes with synchronized wake are supported with variable sleep and wake times.

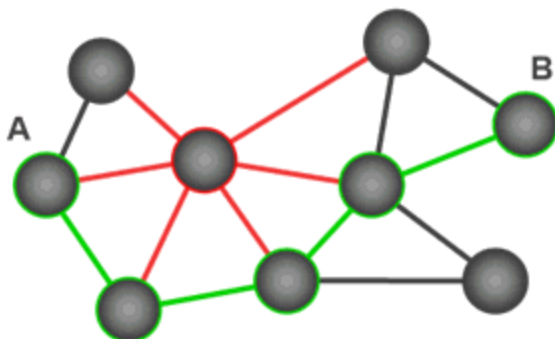

With mesh networking, the distance between two nodes does not matter as long as there are enough nodes in between to pass the message along. When one node wants to communicate with another, the network automatically calculates the best path.

A mesh network is also reliable and offers redundancy. For example, If a node can no longer operate because it has been removed from the network or because a barrier blocks its ability to communicate, the rest of the nodes can still communicate with each other, either directly or through intermediate nodes.

---

**Note** Mesh networks use more bandwidth for administration and therefore have less available for payloads.

---

## DigiMesh feature set

DigiMesh contains the following features:

- **Self-healing**  
Any node may enter or leave the network at any time without causing the network as a whole to fail.
- **Peer-to-peer architecture**  
No hierarchy and no parent-child relationships are needed.
- **Quiet protocol**  
Routing overhead will be reduced by using a reactive protocol similar to AODV.
- **Route discovery**  
Rather than maintaining a network map, routes will be discovered and created only when needed.
- **Selective acknowledgments**  
Only the destination node will reply to route requests.
- **Reliable delivery**  
Reliable delivery of data is accomplished by means of acknowledgments.

- **Sleep modes**

Low power sleep modes with synchronized wake are supported with variable sleep and wake times.

## Networking concepts

This section provides information on configuring DigiMesh devices and network identifiers.

### Device Configuration

You can configure DigiMesh devices to act as routers or end devices with the **CE** command. By default, all devices in a DigiMesh network act as routers. Devices configured as routers actively relay network unicast and broadcast traffic.

### Network ID

DigiMesh networks are defined with a unique network identifier. Set the identifier using the **ID** command. For devices to communicate they must be configured with the same network identifier. The **ID** parameter allows multiple DigiMesh networks to co-exist on the same physical channel.

## Data transmission and routing

This section provides information on data transmission, routing, throughput, and transmission timeouts.

### Unicast addressing

When devices transmit using DigiMesh unicast, the network uses retries and acknowledgments (ACKs) for reliable data delivery. In a retry and acknowledgment scheme, for every data packet that a device sends, the receiving device must send an acknowledgment back to the transmitting device to let the sender know that the data packet arrived at the receiver. If the transmitting device does not receive an acknowledgment then it re-sends the packet. It sends the packet a finite number of times before the system times out.

The **MR** (Mesh Network Retries) parameter determines the number of mesh network retries. The sender device transmits RF data packets up to **MR + 1** times across the network route, and the receiver transmits ACKs when it receives the packet. If the sender does not receive a network ACK within the time it takes for a packet to traverse the network twice, the sender retransmits the packet.

To send unicast messages while in Transparent operating mode, set the **DH** and **DL** on the transmitting device to match the corresponding **SH** and **SL** parameter values on the receiving device.

### Broadcast addressing

All of the routers in a network receive and repeat broadcast transmissions. Broadcast transmissions do not use ACKs, so the sending device sends the broadcast multiple times. By default, the sending device sends a broadcast transmission four times. The transmissions become automatic retries without acknowledgments. This results in all nodes repeating the transmission four times as well.

In order to avoid RF packet collisions, the network inserts a random delay before each router relays the broadcast message. You can change this random delay time with the **NN** parameter.

Sending frequent broadcast transmissions can quickly reduce the available network bandwidth. Use broadcast transmissions sparingly.

The broadcast address is a 64 bit address with the lowest 16 bits set to 1. The upper bits are set to 0. To send a broadcast transmission:

- Set **DH** to 0.
- Set **DL** to 0xFFFF.

In API operating mode, this sets the destination address to 0x000000000000FFFF.

## Routing

Devices within a mesh network determine reliable routes using a routing algorithm and table. The routing algorithm uses a reactive method derived from Ad-hoc On-demand Distance Vector (AODV). The device uses an associative routing table to map a destination node address with its next hop. By sending a message to the next hop address, the message reaches its destination or is forwarded to an intermediate router which routes the message on to its destination.

The device broadcasts a message with a broadcast address to all neighbors. All routers receiving the message rebroadcast the message **MT+1** times and eventually the message reaches all corners of the network. Packet tracking prevents a node from resending a broadcast message more than **MT+1** times.

## Route discovery

Route discovery is a process that occurs when:

1. The source node does not have a route to the requested destination.
2. A route fails. This happens when the source node uses up its network retries without receiving an ACK.

Route discovery begins by the source node broadcasting a route request (RREQ). We call any router that receives the RREQ and is not the ultimate destination, an intermediate node.

Intermediate nodes may either drop or forward a RREQ, depending on whether the new RREQ has a better route back to the source node. If so, the node saves, updates and broadcasts the RREQ.

When the ultimate destination receives the RREQ, it unicasts a route reply (RREP) back to the source node along the path of the RREQ. It does this regardless of route quality and regardless of how many times it has seen an RREQ before.

This allows the source node to receive multiple route replies. The source node selects the route with the best round trip route quality, which it uses for the queued packet and for subsequent packets with the same destination address.

## DigiMesh throughput

Throughput in a DigiMesh network can vary due to a number of variables, including:

- The number of hops.
- If you enable or disable encryption.
- Sleeping end devices.
- Failures and route discoveries.

The results apply to the 80 kb/s version, 115.2 kb/s serial data rate, 100 KB.

Configuration	Data throughput
Mesh unicast, 1 hop, encryption disabled	35.6 kb/s
Mesh unicast, 3 hop, encryption disabled	11.9 kb/s
Mesh unicast, 6 hop, encryption disabled	7.1 kb/s
Mesh unicast, 1 hop, encryption enabled	35.3 kb/s
Mesh unicast, 3 hop, encryption enabled	11.8 kb/s
Mesh unicast, 6 hop, encryption enabled	7.0 kb/s
Point to point unicast, encryption disabled	54.7 kb/s
Point to point unicast, encryption enabled	53.9 kb/s

Configuration	Data throughput
Point to point unicast, encryption disabled	8.4 kb/s
Point to point unicast, encryption enabled	8.3 kb/s

---

**Note** We made the data throughput measurements by setting the serial interface rate to 115200 b/s, and measuring the time to send 100,000 bytes from source to destination. During the test, no route discoveries or failures occurred.

---

## Transmission timeouts

When a device in API operating mode receives a Transmit Request (0x10, 0x11) frame, or a device in Transparent operating mode meets the packetization requirements (**RO**, **RB**), the time required to route the data to its destination depends on:

- A number of configured parameters.
- Whether the transmission is a unicast or a broadcast.
- If the route to the destination address is known.

Timeouts or timing information is provided for the following transmission types:

- Broadcast transmission
- Unicast transmission on a known route
- Unicast transmission on an unknown route
- Unicast transmission on a broken route

---

**Note** The timeouts in this documentation are theoretical timeouts and are not precisely accurate. Your application should pad the calculated maximum timeouts by a few hundred milliseconds. When you use API operating mode, use [Transmit Status frame - 0x8B](#) as the primary method to determine if a transmission is complete.

---

### ***Unicast one hop time***

unicastOneHopTime is a building block of many of the following calculations. It represents the amount of time it takes to send a unicast transmission between two adjacent nodes. The amount of time

depends on the **%H** parameter.

### ***Transmit a broadcast***

All of the routers in a network must relay a broadcast transmission.

The maximum delay occurs when the sender and receiver are on the opposite ends of the network.

The **NH** and **%H** parameters define the maximum broadcast delay as follows:

$$\text{BroadcastTxTime} = \text{NH} * \text{NN} * \%8$$

Unless **BH** < **NH**, in which case the formula is:

$$\text{BroadcastTxTime} = \text{BH} * \text{NN} * \%8$$

### ***Transmit a unicast with a known route***

When a device knows a route to a destination node, the transmission time is largely a function of the number of hops and retries. The timeout associated with a unicast assumes that the maximum number of hops is necessary, as specified by the **NH** command.

You can estimate the timeout in the following manner:

$$\text{knownRouteUnicastTime} = 2 * \text{NH} * \text{MR} * \text{unicastOneHopTime}$$

### ***Transmit a unicast with an unknown route***

If the transmitting device does not know the route to the destination, it begins by sending a route discovery. If the route discovery is successful, then the transmitting device transmits data. You can estimate the timeout associated with the entire operation as follows:

$$\text{unknownRouteUnicastTime} = \text{BroadcastTxTime} + (\text{NH} * \text{unicastOneHopTime}) + \text{knownRouteUnicastTime}$$

### ***Transmit a unicast with a broken route***

If the route to a destination node changes after route discovery completes, a node begins by attempting to send the data along the previous route. After it fails, it initiates route discovery and, when the route discovery finishes, transmits the data along the new route. You can estimate the timeout associated with the entire operation as follows:

$$\text{brokenRouteUnicastTime} = \text{BroadcastTxTime} + (\text{NH} * \text{unicastOneHopTime}) + (2 * \text{knownRouteUnicastTime})$$



## AT commands

---

Special commands .....	130
MAC/PHY commands .....	131
Diagnostic commands .....	133
Network commands .....	135
Addressing commands .....	137
Addressing discovery/configuration commands .....	141
Diagnostic - addressing commands .....	142
Security commands .....	143
Serial interfacing commands .....	144
I/O settings commands .....	146
I/O sampling commands .....	157
Sleep commands .....	160
Diagnostic - sleep status/timing commands .....	162
Command mode options .....	164
Firmware commands .....	165

## Special commands

The following commands are special commands.

### AC (Apply Changes)

Immediately applies new settings without exiting Command mode.

**Parameter range**

N/A

**Default**

N/A

### FR (Software Reset)

Resets the device. The device responds immediately with an **OK** and performs a reset 100 ms later. If you issue **FR** while the device is in Command Mode, the reset effectively exits Command mode.

**Parameter range**

N/A

**Default**

N/A

### RE command

Restore device parameters to factory defaults.

**Parameter range**

N/A

**Default**

N/A

### WR command

Writes parameter values to non-volatile memory so that parameter modifications persist through subsequent resets.

---

**Note** Once you issue a **WR** command, do not send any additional characters to the device until after you receive the **OK** response.

---

**Parameter range**

N/A

**Default**

N/A

## MAC/PHY commands

The following AT commands are MAC/PHY commands.

### CM (Channel Mask)

**CM** allows you to selectively enable or disable channels used for RF communication. This is useful to avoid using frequencies that experience unacceptable levels of RF interference, or to operate two networks of radios on separate frequencies.

This mask limits the channels where the device transmits. See [Technical specifications](#) for the list of frequencies. Channel 0 is bit 0. You must enable at least two channels, except when using only a single frequency of 869.85 MHz. When you use this mode (use 0x20000000), LBT+AFA is disabled and requires the power level to be 5 mW e.r.p. or less.

This command is a bitfield.

The **CM** command does not limit receive channels. If two devices have mutually exclusive values for **CM** (for example 0x0000FF00 and 0x000000FF), then communication is possible because both devices still listen on all possible channels, while limiting the transmission channels to those specified in the **CM** command.

#### Parameter range

0 - 0x3FFFFFFF [bitfield]

#### Default

Europe: 0x3FFFFFFF (channels 0 - 29, 863.15 - 869.85 MHz)

Europe (single frequency mode): 0x20000000 (channel 29, 869.85 MHz)

### HP (Preamble ID)

The preamble ID for which the device communicates. Only devices with matching preamble IDs can communicate with each other. Different preamble IDs minimize interference between multiple sets of devices operating in the same vicinity. When receiving a packet, the device checks this before the network ID, as it is encoded in the preamble, and the network ID is encoded in the MAC header.

#### Parameter range

0 - 9

#### Default

0

### ID (Network ID)

Set or read the user network identifier.

Devices must have the same network identifier to communicate with each other.

When receiving a packet, the device check this after the preamble ID. If you are using Original equipment manufacturer (OEM) network IDs, **0xFFFF** uses the factory value.

#### Parameter range

0 - 0x7FFF

**Default**

0x7FFF

**MT (Broadcast Multi-Transmits)**

Set or read the number of additional MAC-level broadcast transmissions. All broadcast packets are transmitted **MT**+1 times to ensure they are received.

**Parameter range**

0 - 5

**Default**

3

**PL (TX Power Level)**

Sets or displays the power level at which the device transmits conducted power. These values include the gain of a 2 dBi antenna. The conducted power is 2 dBi less.

**Parameter range**

These parameters equate to the following settings for the XBee 868LP RF Module.

Setting	Power level
0	2 mW EIRP
1	5 mW EIRP
2	10 mW EIRP
3	16 mW EIRP
4	25 mW EIRP

**Default**

4

**RR (Unicast Mac Retries)**

Set or read the maximum number of MAC level packet delivery attempts for unicasts. If **RR** is non-zero, the sent unicast packets request an acknowledgment from the recipient. Unicast packets can be retransmitted up to **RR** times if the transmitting device does not receive a successful acknowledgment.

**Parameter range**

0 - 0xF

**Default**

0x10

## ED (Energy Detect)

Starts an energy detect scan. This command accepts an argument to specify the time in milliseconds to scan all channels. The device loops through all the available channels until the time elapses. It returns the maximal energy on each channel, a comma follows each value, and the list ends with a carriage return. The values returned reflect the energy level that **ED** detects in -dBm units.

### Parameter range

0 - 0xFF

### Default

0x10

## Diagnostic commands

The following AT commands are diagnostic commands. Diagnostic commands are typically volatile and will not persist across a power cycle.

## BC (Bytes Transmitted)

The number of RF bytes transmitted. The firmware counts every byte of every packet, including MAC/PHY headers and trailers. The purpose of this count is to estimate battery life by tracking time spent performing transmissions.

This number rolls over to **0** from **0xFFFF**.

You can reset the counter to any unsigned 16-bit value by appending a hexadecimal parameter to the command.

### Parameter range

0 - 0xFFFF

### Default

0

## DB (Last Packet RSSI)

Reports the RSSI in -dBm of the last received RF data packet. **DB** returns a hexadecimal value for the -dBm measurement.

For example, if **DB** returns 0x60, then the RSSI of the last packet received was -96 dBm.

The XBee 868LP RF Module reports RSSI values within approximately 15 dBm of the sensitivity level of the device.

Signals which exceed approximately -85 dBm are reported as approximately -85 dBm.

**DB** only indicates the signal strength of the last hop. It does not provide an accurate quality measurement for a multihop link.

### Parameter range

0 - 0xFF [read-only]

### Default

0

## ER (Received Error Count)

This count increments when a device receives a packet that contains integrity errors of some sort. When the number reaches 0xFFFF, the firmware does not count further events.

To reset the counter to any 16-bit unsigned value, append a hexadecimal parameter to the **ER** command.

### Parameter range

0 - 0xFFFF

### Default

0

## GD (Good Packets Received)

This count increments when a device receives a good frame with a valid MAC header on the RF interface. Once the number reaches 0xFFFF, it does not count further events.

To reset the counter to any 16-bit unsigned value, append a hexadecimal parameter to the command.

### Parameter range

0 - 0xFFFF

### Default

0

## EA (MAC ACK Timeouts)

This count increments whenever a MAC ACK timeout occurs on a MAC-level unicast. When the number reaches **0xFFFF**, the firmware does not count further events.

To reset the counter to any 16-bit value, append a hexadecimal parameter to the command.

### Parameter range

0 - 0xFFFF

### Default

0

## TR (Transmission Errors)

This count increments whenever a MAC transmission attempt exhausts all MAC retries without ever receiving a MAC acknowledgment message from the destination node. Once the number reaches **0xFFFF**, it does not count further events.

To reset the counter to any 16-bit value, append a hexadecimal parameter to the command.

### Parameter range

0 - 0xFFFF

### Default

0

## UA (MAC Unicast Transmission Count)

This count increments whenever a MAC unicast transmission occurs that requests an ACK. Once the number reaches 0xFFFF, it does not count further events.

You can reset the counter to any 16-bit unsigned value by appending a hexadecimal parameter to the command.

### Parameter range

0 - 0xFFFF

### Default

0

## %H (MAC Unicast One Hop Time)

The MAC unicast one hop time timeout in milliseconds. If you change the MAC parameters it can change this value.

### Parameter range

[read-only]

### Default

0xCF

## %8 (MAC Broadcast One Hop Time)

The MAC broadcast one hop time timeout in milliseconds. If you change MAC parameters, it can change this value.

### Parameter range

[read-only]

### Default

0x1BE

## Network commands

The following commands are network commands.

### CE (Node Messaging Options)

The routing and messaging mode bit field of the device.

A routing device repeats broadcasts. Indirect Messaging Coordinators do not transmit point-to-multipoint unicasts until an end device requests them. Setting a device as an end device causes it to regularly send polls to its Indirect Messaging Coordinator. Nodes can also be configured to route, or not route, multi-hop packets.

Bit	Description
Bit 0	Indirect Messaging Coordinator enable. All point-to-multipoint unicasts will be held until requested by a polling end device.
Bit 1	Disable routing on this node. When set, this node will not propagate broadcasts or become an intermediate node in a DigiMesh route. This node will not function as a repeater.
Bit 2	Indirect Messaging Polling enable. Periodically send requests for messages held by the node's coordinator.

---

**Note** Bit 0 and Bit 2 cannot be set at the same time.

---

#### Parameter range

0 - 6

#### Default

0

### BH command

The number of hops for broadcast data transmissions.

Set the value to **0** for the maximum number of hops.

If you set **BH** greater than **NH**, the device uses the value of **NH**.

#### Parameter range

0 - 0x20

#### Default

0

### NH (Network Hops)

The maximum number of hops expected to be seen in a network route. This value does not limit the number of hops allowed, but it is used to calculate timeouts waiting for network acknowledgments.

Both variants are supported.

#### Parameter range

1 - 0x20

#### Default

7

### NN (Network Delay Slots)

Set or read the maximum random number of network delay slots before rebroadcasting a network packet.



**Parameter range**

1 - 5

**Default**

3

**MR (Mesh Unicast Retries)**

Set or read the maximum number of network packet delivery attempts. If **MR** is non-zero, the packets a device sends request a network acknowledgment, and can be resent up to **MR+1** times if the device does not receive an acknowledgment.

We recommend that you set this value to **1**.

If you set this parameter to **0**, it disables network ACKs. Initially, the device can find routes, but a route will never be repaired if it fails.

**Parameter range**

0 - 7

**Default**

1

## Addressing commands

The following AT commands are addressing commands.

**SH command**

Displays the upper 32 bits of the unique IEEE 64-bit extended address assigned to the XBee in the factory.

**Parameter range**

0 - 0xFFFFFFFF [read-only]

**Default**

Set in the factory

**SL command**

Displays the lower 32 bits of the unique IEEE 64-bit RF extended address assigned to the XBee in the factory.

**Parameter range**

0 - 0xFFFFFFFF [read-only]

**Default**

Set in the factory

## DH command

Set or read the upper 32 bits of the 64-bit destination address. When you combine **DH** with **DL**, it defines the destination address that the device uses for transmissions in Transparent mode.

### Parameter range

0 - 0xFFFFFFFF

### Default

0

## DL command

Set or display the lower 32 bits of the 64-bit destination address. When you combine **DH** with **DL**, it defines the destination address that the device uses for transmissions in Transparent mode.

**0x000000000000FFFF** is the broadcast address.

### Parameter range

0 - 0xFFFFFFFF

### Default

0x0000FFFF

## TO command

The bitfield that configures the transmit options for Transparent mode.

The device's transmit options. The device uses these options for all transmissions. You can override these options using the TxOptions field in the API TxRequest frames.

### Parameter range

Bit	Meaning	Description
6,7	Delivery method	b'00 = <invalid option> b'01 = Point-multipoint b'10 = Repeater mode (directed broadcast of packets) b'11 = DigiMesh (not available on 10k product)
5	Reserved	<set this bit to 0>
4	Reserved	<set this bit to 0>
3	Trace Route	Enable a Trace Route on all DigiMesh API packets
2	NACK	Enable a NACK messages on all DigiMesh API packets
1	Disable RD	Disable Route Discovery on all DigiMesh unicasts
0	Disable ACK	Disable acknowledgments on all unicasts

**Example 1:** Set **TO** to **0x80** to send all transmissions using repeater mode.

**Example 2:** Set **TO** to **0xC1** to send transmissions using DigiMesh, with network acknowledgments disabled.

- Bits 6 and 7 cannot be set to DigiMesh on the 10k build.
- Bits 4 and 5 must be set to 0.
- Bits 1, 2, and 3 cannot be set on the 10k build.

When you set **BR** to **0** the **TO** option has the DigiMesh and Repeater mode disabled automatically.

#### Default

0x40 (10k product)

0xC0 (80k product)

## NI command

Stores the node identifier string for a device, which is a user-defined name or description of the device. This can be up to 20 ASCII characters.

- The command automatically ends when the maximum bytes for the string have been entered.

Use the **ND** (Network Discovery) command with this string as an argument to easily identify devices on the network.

The **DN** command also uses this identifier.

#### Parameter range

A string of case-sensitive ASCII printable characters from 0 to 20 bytes in length. A carriage return or a comma automatically ends the command.

#### Default

One ASCII space character (0x20)

## NT (Node Discover Timeout)

Sets the amount of time a base node waits for responses from other nodes when using the **ND** (Node Discover) or **DN** (Discover Node) commands. The value randomizes the responses to alleviate network congestion.

#### Parameter range

0x20 - 0x2EE0 (x 100 ms)

#### Default

0x82 (13 seconds)

## NO (Node Discovery Options)

Set or read the network discovery options value for the **ND** (Network Discovery) command on a particular device. The options bit field value changes the behavior of the **ND** command and what optional values the local device returns when it receives an **ND** command or API Node Identification Indicator (0x95) frame.

#### Parameter range

0x0 - 0x7 (bit field)

Option	Description
0x01	Append the <b>DD</b> (Digi Device Identifier) value to <b>ND</b> responses or API node identification frames.
0x02	Local device sends <b>ND</b> or <b>FN</b> (Find Neighbors) response frame when the <b>ND</b> is issued.
0x04	Append the RSSI of the last hop to <b>ND</b> , <b>FN</b> , and responses or API node identification frames.

**Default**

0x0

**CI (Cluster ID)**

The application layer cluster ID value. The device uses this value as the cluster ID for all data transmissions. The default value 0x11 (Transparent data cluster ID).

**Parameter range**

0 - 0xFFFF

**Default**

0x11

**DE command**

Sets or displays the application layer destination ID value. The value is used as the destination endpoint for all data transmissions. The default value (0xE8) is the Digi data endpoint.

**Parameter range**

0 - 0xFF

**Default**

0xE8

**SE command**

Sets or displays the application layer source endpoint value. The value is used as the source endpoint for all data transmissions. The default value (0xE8) is the Digi data endpoint.

Sets or displays the application layer source endpoint value used for data transmissions.

This command only affects outgoing transmissions in transparent mode (**AP=0**).

0xE8 is the Digi data endpoint used for outgoing data transmissions.

0xE6 is the Digi device object endpoint used for configuration and commands.

**Parameter range**

0 - 0xFF

**Default**

0xE8

## Addressing discovery/configuration commands

### AG (Aggregator Support)

The **AG** command sends a broadcast through the network that has the following effects on nodes that receive the broadcast:

- The receiving node establishes a DigiMesh route back to the originating node, if there is space in the routing table.
- The **DH** and **DL** of the receiving node update to the address of the originating node if the **AG** parameter matches the current **DH/DL** of the receiving node.
- API-enabled devices with updated **DH** and **DL** send an Aggregate Addressing Update frame (0x8E) out the serial port.

#### Parameter range

Any 64-bit address

#### Default

N/A

### DN (Discover Node)

Resolves an **NI** (Node identifier) string to a physical address (case sensitive).

The following events occur after **DN** discovers the destination node:

When **DN** is sent in Command mode:

1. The device sets **DL** and **DH** to the extended (64-bit) address of the device with the matching **NI** string.
2. The receiving device returns **OK** (or **ERROR**).
3. The device exits Command mode to allow for immediate communication. If an **ERROR** is received, the device does not exit Command mode.

When **DN** is sent as an API frame, the receiving device returns 0xFFFE followed by its 64-bit extended addresses in an API Command Response frame.

#### Parameter range

20-byte ASCII string

#### Default

N/A

### ND (Network Discover)

The command reports the following information after a jittered time delay.

**MY**<CR>

**SH**<CR>

**SL**<CR>

**DB**<CR> (Contains the detected signal strength of the response in negative dBm units)

**NI**<CR> (Variable length)

<CR>

After (**NT** \* 100) milliseconds, the command ends by returning a <CR>. **ND** also accepts a **NI** (Node Identifier) as a parameter (optional). In this case, only a device that matches the supplied identifier responds.

If you send ND through a local API frame, the device returns each response as a separate AT\_CMD\_Response packet. The data consists of the above listed bytes without the carriage return delimiters. The **NI** string ends in a "0x00" null character.

#### Parameter range

N/A

#### Default

N/A

## FN (Find Neighbors)

Discovers and reports all devices found within immediate (1 hop) RF range. **FN** reports the following information for each device it discovers:

**MY**<CR> (always 0xFFFE)

**SH**<CR>

**SL**<CR>

**NI**<CR> (Variable length)

PARENT\_NETWORK\_ADDRESS<CR> (2 Bytes) (always 0xFFFE)

DEVICE\_TYPE<CR> (1 Byte: 0 = Coordinator, 1 = Router, 2 = End Device)

STATUS<CR> (1 Byte: Reserved)

PROFILE\_ID<CR> (2 Bytes)

MANUFACTURER\_ID<CR> (2 Bytes)

DIGI\_DEVICE\_TYPE<CR> (4 Bytes. Optionally included based on **NO** settings.)

RSSI OF LAST HOP<CR> (1 Byte. Optionally included based on **NO** settings.)

<CR>

If you send the **FN** command in Command mode, after (**NT**\*100) ms + overhead time, the command ends by returning a carriage return, represented by <CR>.

If you send the **FN** command through a local API frame, each response returns as a separate Local or Remote AT Command Response API packet, respectively. The data consists of the bytes in the previous list without the carriage return delimiters. The **NI** string ends in a 0x00 null character.

#### Parameter range

N/A

#### Default

N/A

## Diagnostic - addressing commands

The following AT command is a Diagnostic - addressing command.

## N? (Network Discovery Timeout)

The maximum response time, in milliseconds, for **ND** (Network Discovery) responses and **DN** (Discover Node) responses. The timeout is based on the **NT** (Network Discovery Back-off Time) and the network propagation time.

### Parameter range

[read-only]

### Default

N/A

## Security commands

The following AT commands are security commands.

### EE (Security Enable)

Enables or disables 128-bit Advanced Encryption Standard (AES) encryption. Set this command parameter the same on all devices in a network.

### Parameter range

0 - 1

Parameter	Description
0	Encryption Disabled
1	Encryption Enabled

### Default

0

### KY (AES Encryption Key)

Sets the 16-byte network security key value that the device uses for encryption and decryption.

This command is write-only. If you attempt to read **KY**, the device returns an **OK** status.

Set this command parameter the same on all devices in a network.

The value passes in as hex characters when you set it from AT command mode, and as binary bytes when you set it in API mode.

### Parameter range

128-bit value

### Default

N/A

## Serial interfacing commands

### BD (Baud Rate)

Sets or displays the serial interface baud rate for communication between the device's serial port and the host.

Values from 0 - 8 select preset standard rates.

Values at 0x100 and above select the actual baud rate if the host supports it.

#### Parameter range

Standard baud rates: 0x0 - 0x8

Non-standard baud rates: 0x100 to 0x6ACFC0

Parameter	Description
0x0	1200 b/s
0x1	2400 b/s
0x2	4800 b/s
0x3	9600 b/s
0x4	19200 b/s
0x5	38400 b/s
0x6	57600 b/s
0x7	115200 b/s
0x8	230400 b/s
The baud rate limit is 7 Mb/s.	

#### Default

0x03 (9600 b/s)

### NB (Parity)

Set or read the serial parity settings for UART communications.

#### Parameter range

0x00 - 0x02

Parameter	Description
0x00	No parity
0x01	Even parity
0x02	Odd parity



Parameter	Description
0	No parity
1	Even parity
2	Odd parity

**Default**

0x00

**SB command**

Sets or displays the number of stop bits for UART communications.

**Parameter range**

0 - 1

Parameter	Configuration
0	One stop bit
1	Two stop bits

**Default**

0

**RO command**

Set or read the number of UART character times of inter-character silence required before transmission begins when operating in Transparent mode.

Set **RO** to 0 to transmit characters as they arrive instead of buffering them into one RF packet.

**Parameter range**

0 - 0xFF (x character times)

**Default**

3

**FT (Flow Control Threshold)**

Set or display the flow control threshold.

The device de-asserts  $\overline{\text{CTS}}$  and/or send XOFF when **FT** bytes are in the UART receive buffer. It re-asserts CTS when less than **FT**-16 bytes are in the UART receive buffer.

**Parameter range**

0x11 - 0x16F bytes

**Default**

0x13F

## API Mode

Sets or reads the UART API mode.

### Parameter range

0 - 2

The following settings are allowed:

Parameter	Description
0	Transparent mode, API mode is off. All UART input and output is raw data and the device uses the <b>RO</b> parameter to delineate packets.
1	API Mode Without Escapes. The device packetizes all UART input and output data in API format, without escape sequences.
2	API Mode With Escapes. The device is in API mode and inserts escaped sequences to allow for control characters. The device passes XON, XOFF, Escape, and the 0x7E delimiter as data.

### Default

0

## AO command

The API data frame output format for RF packets received. This parameter applies to both the UART and SPI interfaces.

### Parameter range

0, 1

Parameter	Description
0	API Rx Indicator - 0x90, this is for standard data frames.
1	API Explicit Rx Indicator - 0x91, this is for Explicit Addressing data frames.

### Default

0

## I/O settings commands

The following AT commands are I/O settings commands.

### CB command

Use **CB** to simulate commissioning pushbutton presses in software.

Set the parameter value to the number of button presses that you want to simulate. For example, send **CB1** to perform the action of pressing the Commissioning Pushbutton once.

See [The Commissioning Pushbutton](#).

See [Commissioning pushbutton](#).

**Parameter range**

0 - 4

**Default**

N/A

**D0 (AD0/DIO0 Configuration)**

Sets or displays the DIO0/AD0 configuration (pin 33).

**Parameter range**

0 - 5

Parameter	Description
0	Disabled
1	Commissioning Pushbutton
2	ADC
3	Digital input
4	Digital output, low
5	Digital output, high

**Default**

1

**D1 (DIO1/AD1)**

Sets or displays the DIO1/AD1 configuration (pin 32).

**Parameter range**

0, 2 - 5

Parameter	Description
0	Disabled
2	ADC
3	Digital input
4	Digital output, low
5	Digital output, high
6	PTI_EN

**Default**

0

**D2 (DIO2/AD2)**

Sets or displays the DIO2/AD2 configuration (pin 31).

**Parameter range**

0, 2 - 5

Parameter	Description
0	Disabled
2	ADC
3	Digital input
4	Digital output, low
5	Digital output, high

**Default**

0

**D3 (DIO3/AD3)**

Sets or displays the DIO3/AD3 configuration (pin 30).

**Parameter range**

0, 2 - 5

Parameter	Description
0	Disabled
2	ADC
3	Digital input
4	Digital output, low
5	Digital output, high

**Default**

0

**D4 (DIO4/AD4)**

Sets or displays the DIO4 configuration (pin 24).

**Parameter range**

0, 3 - 5

Parameter	Description
0	Disabled
3	Digital input
4	Digital output, low
5	Digital output, high

**Default**

0

**D5 (DIO5/ASSOCIATED\_INDICATOR)**

Sets or displays the DIO5/AD5/ASSOCIATED\_INDICATOR configuration (pin 28).

**Parameter range**

0, 1, 3 - 5

Parameter	Description
0	Disabled
1	Associate LED indicator - blinks when associated
3	Digital input
4	Digital output, default low
5	Digital output, default high

**Default**

1

**D6 (DIO6/RTS)**

Sets or displays the DIO6/ $\overline{\text{RTS}}$  configuration (pin 29).

**Parameter range**

0, 1, 3 - 5

Parameter	Description
0	Disabled
1	$\overline{\text{RTS}}$ flow control
3	Digital input
4	Digital output, low
5	Digital output, high

**Default**

0

**D7 (DIO7/CTS)**Sets or displays the DIO7/ $\overline{\text{CTS}}$  configuration (pin 25).**Parameter range**

0, 1, 3 - 7

Parameter	Description
0	Disabled
1	$\overline{\text{CTS}}$ flow control
3	Digital input
4	Digital output, low
5	Digital output, high
6	RS-485 Tx enable, low Tx (0 V on transmit, high when idle)
7	RS-485 Tx enable high, high Tx (high on transmit, 0 V when idle)

**Default**

0x1

**D8 (DIO8/SLEEP\_REQUEST)**

Sets or displays the DIO8/SLEEP\_REQUEST configuration (pin 10).

**Parameter range**

0, 1, 3 - 5

Parameter	Description
0	Disabled
1	Sleep request
2	N/A
3	Digital input
4	Digital output, low
5	Digital output, high

**Default**

1

**D9 (DIO9/ON\_SLEEP)**

Sets or displays the DIO9/ON\_SLEEP configuration (pin 26).

**Parameter range**

0, 1, 3 - 5

Parameter	Description
0	Disabled
1	ON/SLEEP output
3	Digital input
4	Digital output, low
5	Digital output, high

**Default**

1

**P0 (DIO10/RSSI/PWM0 Configuration)**

Sets or displays the PWM0/RSSI/DIO10 configuration (pin 7).

**Parameter range**

0 - 5

Parameter	Description
0	Disabled
1	RSSI PWM0 output
2	PWM0 output
3	Digital input
4	Digital output, low
5	Digital output, high

**Default**

1

**P1 (DIO11/PWM1 Configuration)**

Sets or displays the DIO11/PWM1 configuration (pin 8).

**Parameter range**

0 - 5

Parameter	Description
0	Disabled
1	32.768 kHz clock output
2	PWM1 output
3	Digital input
4	Digital output, low
5	Digital output, high

**Default**

0

**P2 (DIO12 Configuration)**

Sets or displays the DIO12 configuration (pin 5).

**Parameter range**

0, 3 - 5

Parameter	Description
0	Disabled
3	Digital input
4	Digital output, low
5	Digital output, high

**Default**

0

**P3 (DIO13/DOUT)**

Sets or displays the DIO13/DOUT configuration (pin 3).

**Parameter range**

0, 1

Parameter	Description
0	Disabled
1	UART DOUT output

**Default**

1



**P4 (DIO14/DIN)**

Sets or displays the DIO14/DIN configuration (pin 4).

**Parameter range**

0 - 1

Parameter	Description
0	Disabled
1	UART DIN/input

**Default**

1

**P5 (SPI\_MISO)**

Sets or displays the DIO15/SPI\_MISO configuration (pin 17).

**Parameter range**

0, 1

0, 1, 4, 5

Parameter	Description
0	Disabled
1	SPI_MISO
4	Digital output low
5	Digital output high

**Default**

1

**P6 (SPI\_MOSI Configuration)**

Sets or displays the DIO16/SPI\_MOSI configuration (pin 16).

**Parameter range**

0, 1, 4, 5

Parameter	Description
0	Disabled
1	SPI_MOSI
4	Digital output low
5	Digital output, high

**Default**

1

**P7 (DIO17/SPI\_SSEL )**

Sets or displays the DIO17/SPI\_SSEL configuration (pin 15).

**Parameter range**

0, 1, 4, 5

Parameter	Description
0	Disabled
1	SPI_SSEL
4	Digital output low
5	Digital output, high

**Default**

1

**P8 (DIO18/SPI\_SCLK)**

Sets or displays the DIO18/SPI\_SCLK configuration (pin 14).

**Parameter range**

0, 1, 4, 5

Parameter	Description
0	Disabled
1	SPI_SCLK
4	Digital output low
5	Digital output high

**Default**

1

**P9 (SPI\_ATTN)**

Sets or displays the DIO19/SPI\_ATTN configuration (pin 12).

**Parameter range**

0, 1, 4 - 6

Parameter	Description
0	Disabled
1	SPI_ $\overline{\text{ATTN}}$
4	Digital output low
5	Digital output high
6	UART data present indicator

**Default**

1

**PD (Pull Up/Down Direction)**

The resistor pull direction bit field (1 = pull-up, 0 = pull-down) for corresponding I/O lines that are set by the **PR** command.

**Parameter range**

0x0 - 0xFFFFF (bit field)

**Default**

0x0

**PR (Pull-up/Down Resistor Enable)**

The bit field that configures the internal pull-up/down resistor status for the I/O lines.

- If you set a **PR** bit to 1, it enables the pull-up/down resistor
- If you set a **PR** bit to 0, it specifies no internal pull-up/down resistor.

**PR** and **PD** only affect lines that are configured as digital inputs or disabled.

The following table defines the bit-field map for **PR** and **PD** commands.

Bit	I/O line	Device pin	Range
0	DIO4/AD4	pin 24	40 k $\Omega$
1	DIO3/AD3	pin 30	40 k $\Omega$
2	DIO2/AD2	pin 31	40 k $\Omega$
3	DIO1/AD1	pin 32	40 k $\Omega$
4	DIO0/AD0	pin 33	40 k $\Omega$
5	DIO6/ $\overline{\text{RTS}}$	pin 29	40 k $\Omega$
6	DIO8/SLEEP_RQ/ $\overline{\text{DTR}}$	pin 10	40 k $\Omega$
7	DIN/ $\overline{\text{CONFIG}}$	pin 4	40 k $\Omega$
8	DIO5/ASSOCIATE	pin 28	40 k $\Omega$

Bit	I/O line	Device pin	Range
9	DIO9/On/SLEEP	pin 26	40 kΩ
10	DIO12	pin 5	40 kΩ
11	DIO10/PWM0/RSSI	pin 7	40 kΩ
12	DIO11/PWM1	pin 8	40 kΩ
13	DIO7/CTS	pin 25	40 kΩ
14	DOUT	pin 3	40 kΩ
15	DIO15/SPI_MISO	pin 17	40 kΩ
16	DIO16/SPI_MOSI	pin 16	40 kΩ
17	DIO17/SPI_SSEL	pin 15	40 kΩ
18	DIO18/SPI_SCLK	pin 14	40 kΩ
19	DIO19/SPI_ATTN	pin 12	40 kΩ

**Parameter range**

0 - 0xFFFF (bit field)

**Default**

0xFFFF

**M0 (PWM0 Duty Cycle)**

The duty cycle of the PWM0 line (pin 7).

Use the **P0** command to configure the line as a PWM output.**Parameter range**

0 - 0x3FF

**Default**

0

**M1 (PWM1 Duty Cycle)**

The duty cycle of the PWM1 line (pin 8).

Use the **P1** command to configure the line as a PWM output.**Parameter range**

0 - 0x3FF

**Default**

0

## LT command

Set or read the Associate LED blink time. If you use the **D5** command to enable the Associate LED functionality (DIO5/Associate pin), this value determines the on and off blink times for the LED when the device has joined the network.

If **LT = 0**, the device uses the default blink rate: 500 ms for a sleep coordinator, 250 ms for all other nodes.

For all other **LT** values, the firmware measures **LT** in 10 ms increments.

### Parameter range

0x14 - 0xFF (x 10 ms)

### Default

0

## RP command

The PWM timer expiration in 0.1 seconds. **RP** sets the duration of pulse width modulation (PWM) signal output on the RSSI pin.

When **RP = 0xFF**, the output is always on.

### Parameter range

0 - 0xFF (x 100 ms)

### Default

0x28 (four seconds)

## I/O sampling commands

The following AT commands configure I/O sampling parameters.

### AV (Analog Voltage Reference)

The analog voltage reference used for A/D sampling.

### Parameter range

0, 1

Parameter	Description
0	1.25 V reference
1	2.5 V reference

### Default

0

### IC (DIO Change Detection)

Set or read the digital I/O pins to monitor for changes in the I/O state.

**IC** works with the individual pin configuration commands (**D0 - D9, P0 - P2**). If you enable a pin as a digital I/O, you can use the **IC** command to force an immediate I/O sample transmission when the DIO state changes. IC is a bitmask that you can use to enable or disable edge detection on individual channels.

Set unused bits to 0.

Bit	I/O line
0	DIO0
1	DIO1
2	DIO2
3	DIO3
4	DIO4
5	DIO5
6	DIO6
7	DIO7
8	DIO8
9	DIO9
10	DIO10
11	DIO11
12	DIO12

**Parameter range**

0 - 0xFFFF (bit field)

**Default**

0

## IF (Sleep Sample Rate)

Set or read the number of sleep cycles that must elapse between periodic I/O samples. This allows the firmware to take I/O samples only during some wake cycles. During those cycles, the firmware takes I/O samples at the rate specified by **IR**.

**Parameter range**

1 - 0xFF

**Default**

1

t b

## IR (I/O Sample Rate)

Set or read the I/O sample rate to enable periodic sampling.

If you set the I/O sample rate to greater than **0**, the device samples all enabled digital I/O and analog inputs at a specified interval. Samples are sent to the address specified by the **DH** and **DL** commands.

To enable periodic sampling, set **IR** to a non-zero value, and enable the analog or digital I/O functionality of at least one device pin. The sample rate is measured in milliseconds.



**WARNING!** If you set **IR** to 1 or 2, the device will not keep up and many samples will be lost.

---

### Parameter range

0 - 0xFFFF (x 1 ms)

### Default

0

## TP (Temperature)

The current module temperature in degrees Celsius in 8-bit two's complement format. For example 0x1A = 26 °C, and 0xF6 = -10 °C.

### Parameter range

0 - 0xFF [read-only]

### Default

N/A

## IS command

Forces a read of all enabled digital and analog input lines.

### Parameter range

N/A

### Default

N/A

## %V (Voltage Supply Monitoring)

Displays the supply voltage of the device in mV units.

### Parameter range

This is a read-only parameter

### Default

N/A

## Sleep commands

The following AT commands are sleep commands.

### SM command

Sets or displays the sleep mode of the device.

#### Parameter range

0, 1, 4, 5, 7, 8

Parameter	Description
0	Normal.
1	Pin sleep. In this mode, the sleep/wake state of the module is controlled by the SLEEP_REQUEST line.
4	Asynchronous Cyclic Sleep. In this mode, the device periodically sleeps and wakes based on the <b>SP</b> and <b>ST</b> commands.
5	Asynchronous cyclic sleep with pin wake-up. In this mode, the device is similar to asynchronous cyclic sleep. The device terminates a sleep period when it detects a falling edge of the SLEEP_REQUEST line.
7	Sleep Support
8	Synchronized Cyclic Sleep

#### Default

0

### SO command

Set or read the sleep options bit field of a device. This command is a bitmask.

You cannot set bit 0 and bit 1 at the same time.

#### Parameter range

0 - 0x13E [bit field]

For synchronous sleep devices, the following sleep bit field options are defined:

Bit	Option
0	Preferred sleep coordinator; setting this bit causes a sleep compatible device to always act as sleep coordinator
1	Non-sleep coordinator; setting this bit causes a device to never act as a sleep coordinator
2	Enable API sleep status messages
3	Disable early wake-up for missed syncs
4	Enable node type equality (disables seniority based on device type)
5	Disable lone coordinator sync repeat



For asynchronous sleep devices, the following sleep bit field options are defined:

Bit	Option
8	Always wake for <b>ST</b> time

**Default**

0x2 (non-sleep coordinator)

**SN command**

Set or read the number of sleep periods value. This command controls the number of sleep periods that must elapse between assertions of the ON\_SLEEP line during the wake time of Asynchronous Cyclic Sleep.

During cycles when ON\_SLEEP is de-asserted, the device wakes up and checks for any serial or RF data. If it receives any such data, then it asserts the ON\_SLEEP line and the device wakes up fully. Otherwise, the device returns to sleep after checking.

This command does not work with synchronous sleep devices.

**Parameter range**

1 - 0xFFFF

**Default**

1

**SP (Sleep Period)**

Sets or displays the device's sleep time. This command defines the amount of time the device sleeps per cycle.

For a node operating as an Indirect Messaging Coordinator, this command defines the amount of time that it will hold an indirect message for an end device. The coordinator will hold the message for (2.5 \* SP).

**Parameter range**

0x1 - 0x15F900 (x 10 ms)

**Default**

0x190 (4 seconds)

**ST (Wake Time)**

Sets or displays the wake time of the device.

For devices in asynchronous sleep, **ST** defines the amount of time that a device stays awake after it receives RF or serial data.

For devices in synchronous sleep, **ST** defines the amount of time that a device stays awake when operating in cyclic sleep mode. The command adjusts the value upwards automatically if it is too small to function properly based on other settings.

**Parameter range**

0x1 - 0x36EE80 (x 1 ms)

**Default**

0x1F40 (8 seconds)

**WH (Wake Host)**

Sets or displays the wake host timer value.

If you set **WH** to a non-zero value, this timer specifies a time in milliseconds that the device delays after waking from sleep before sending data out the UART or transmitting an I/O sample. If the device receives serial characters, the **WH** timer stops immediately.

When in synchronous sleep, the device shortens its sleep period by the **WH** value to ensure it is prepared to communicate when the network wakes up. When in this sleep mode, the device always stays awake for the **WH** time plus the amount of time it takes to transmit a one-hop unicast to another node.

**Parameter range**

0 - 0xFFFF (x 1 ms)

**Default**

0

**Diagnostic - sleep status/timing commands**

The following AT commands are Diagnostic sleep status/timing commands.

**SS (Sleep Status)**

Queries a number of Boolean values that describe the device's status.

Bit	Description
0	This bit is true when the network is in its wake state.
1	This bit is true if the node currently acts as a network sleep coordinator.
2	This bit is true if the node ever receives a valid sync message after it powers on.
3	This bit is true if the node receives a sync message in the current wake cycle.
4	This bit is true if you alter the sleep settings on the device so that the node nominates itself and sends a sync message with the new settings at the beginning of the next wake cycle.
5	This bit is true if you request that the node nominate itself as the sleep coordinator using the Commissioning Pushbutton or the <b>CB2</b> command.
6	This bit is true if the node is currently in deployment mode.
All other bits	Reserved. Ignore all non-documented bits.

**Parameter range**

[read-only]

**Default**

0x40

**OS (Operating Sleep Time)**

Reads the current network sleep time that the device is synchronized to, in units of 10 milliseconds. If the device has not been synchronized, then **OS** returns the value of **SP**.

If the device synchronizes with a sleeping router network, **OS** may differ from **SP**.

**Parameter range**

[read-only]

**Default**

0x190

**OW (Operating Wake Time)**

Reads the current network wake time that a device is synchronized to, in 1 ms units.

If the device has not been synchronized, then **OW** returns the value of **ST**.

If the device synchronizes with a sleeping router network, **OW** may differ from **ST**.

**Parameter range**

[read-only]

**Default**

0

**MS (Missed Sync Messages)**

Reads the number of sleep or wake cycles since the device received a sync message.

Supported in the 80k firmware only.

**Parameter range**

[read-only]

**Default**

0

**SQ (Missed Sleep Sync Count)**

Counts the number of sleep cycles in which the device does not receive a sleep sync.

Set the value to 0 to reset this value.

When the value reaches 0xFFFF it does not increment anymore.

**Parameter range**

0 - 0xFFFF

**Default**

0

## Command mode options

The following commands are Command mode option commands.

### CC (Command Sequence Character)

Sets or displays the character the device uses between guard times of the Command mode sequence. The Command mode sequence causes the device to enter Command mode (from Idle mode).

---

**Note** We recommend using the a value within the range of 0x20 - 0x7F as those are ASCII characters.

---

#### Parameter range

0 - 0xFF

#### Default

0x2B (the ASCII plus character: +)

### CT command

Sets or displays the Command mode timeout parameter. If a device does not receive any valid commands within this time period, it returns to Idle mode from Command mode.

#### Parameter range

2 - 0x1770 (x 100 ms)

#### Default

0x64 (10 seconds)

### CN command

Immediately exits Command Mode and applies pending changes.

#### Parameter range

N/A

#### Default

N/A

### GT command

Set the required period of silence before and after the command sequence characters of the Command mode sequence (**GT + CC + GT**). The period of silence prevents inadvertently entering Command mode.

#### Parameter range

0x2 - 0x95C (x 1 ms)

#### Default

0x3E8 (one second)

## Firmware commands

The following AT commands are firmware commands.

### VL command

Shows detailed version information including the application build date and time.

#### Parameter range

[read-only]

#### Default

N/A

### VR command

Reads the firmware version on a device.

#### Parameter range

0 - 0xFFFFFFFF [read-only]

#### Default

Set in firmware

### HV command

Display the hardware version number of the device.

#### Parameter range

0 - 0xFFFF [read-only]

#### Default

Set in firmware

### HS (Hardware Series)

Read the device's hardware series number.

For example, if the device is version S8B, this returns 0x801.

#### Parameter range

0 - 0xFFFF [read-only]

#### Default

Set in the firmware

### DD command

Stores the Digi device type identifier value. Use this value to differentiate between multiple XBee devices.

If you change **DD**, [RE command](#) will not restore defaults. The only way to get **DD** back to default values is to explicitly set it to defaults.

**Parameter range**

0 - 0xFFFFFFFF

**Default**

0xC0000

**NP (Maximum Packet Payload Bytes)**

Reads the maximum number of RF payload bytes that you can send in a transmission.

**Parameter range**

0 - 0xFFFF (bytes) [read-only]

**Default**

0x100

**CK (Configuration CRC)**

Displays the cyclic redundancy check (CRC) of the current AT command configuration settings.

This command allows you to detect an unexpected configuration change on a device.

After a firmware update this command may return a different value.

**Parameter range**

N/A

**Default**

N/A

## Operate in API mode

---

API mode overview .....	168
Frame data .....	173

## API mode overview

As an alternative to Transparent operating mode, you can use API operating mode. API mode provides a structured interface where data is communicated through the serial interface in organized packets and in a determined order. This enables you to establish complex communication between devices without having to define your own protocol. The API specifies how commands, command responses and device status messages are sent and received from the device using the serial interface or the SPI interface.

We may add new frame types to future versions of firmware, so build the ability to filter out additional API frames with unknown frame types into your software interface.

### API frame format

The firmware supports two API operating modes: without escaped characters and with escaped characters. Use the AP command to enable either mode. To configure a device to one of these modes, set the following AP parameter values:

- **AP = 1:** API operation.
- **AP = 2:** API operation (with escaped characters—only possible on UART).

The API data frame structure differs depending on what mode you choose.

#### **API operation (AP parameter = 1)**

The following table shows the data frame structure when you enable **AP = 1**:

Frame fields	Byte	Description
Start delimiter	1	0x7E
Length	2 - 3	Most Significant Byte, Least Significant Byte
Frame data	4 - n	API-specific structure
Checksum	n + 1	1 byte

The firmware silently discards any data it receives prior to the start delimiter. If the device does not receive the frame correctly or if the checksum fails, the device replies with a device status frame indicating the nature of the failure.

#### **API operation-with escaped characters (AP parameter = 2)**

This mode is only available on the UART, not on the SPI serial port. The following table shows the data frame structure when you enable **AP = 2**:

Frame fields	Byte	Description	
Start delimiter	1	0x7E	
Length	2 - 3	Most Significant Byte, Least Significant Byte	Characters escaped if needed
Frame data	4 - n	API-specific structure	
Checksum	n + 1	1 byte	



### Escape characters

When you are sending or receiving a UART data frame, specific data values must be escaped (flagged) so they do not interfere with the data frame sequencing. To escape an interfering data byte, insert 0x7D and follow it with the byte to be escaped XOR'd with 0x20.

### Data bytes that need to be escaped:

Byte	Description
0x7E	Frame Delimiter
0x7D	Escape
0x11	XON
0x13	XOFF

#### Example: Raw serial data before escaping interfering bytes:

0x7E 0x00 0x02 0x23 0x11 0xCB

0x11 needs to be escaped which results in the following frame:

0x7E 0x00 0x02 0x23 0x7D 0x31 0xCB

---

**Note** In the previous example, the length of the raw data (excluding the checksum) is 0x0002 and the checksum of the non-escaped data (excluding frame delimiter and length) is calculated as:  $0xFF - (0x23 + 0x11) = (0xFF - 0x34) = 0xCB$ .

---

### Length

The length field specifies the total number of bytes included in the frame's data field. Its two-byte value excludes the start delimiter, the length, and the checksum.

### Frame data

This field contains the information that a device receives or transmits. The structure of frame data depends on the purpose of the API frame:

Start delimiter	Length		Frame data								Checksum
			API identifier	Identifier-specific Data							
1	2	3	4	5	6	7	8	9	...	n	n+1
0x7E	MSB	LSB	cmdID	cmdData							Single byte

The cmdID frame (API-identifier) indicates which API messages contains the cmdData frame (Identifier-specific data). The device sends multi-byte values big endian format.

The XBee 868LP RF Module supports the following API frames:

API frame names	API ID
AT Command	0x08
AT Command - Queue Parameter Value	0x09
Transmit Request	0x10
Explicit Addressing Command Frame	0x11
Remote Command Request	0x17
AT Command Response	0x88
Modem Status	0x8A
Transmit Status	0x8B
Receive Packet (AO=0)	0x90
Explicit Rx Indicator (AO=1)	0x91
I/O Data Sample RX Indicator	0x92
Node Identification Indicator (AO=0)	0x95
Remote Command Response	0x97

## Calculate and verify checksums

To calculate the checksum of an API frame:

1. Add all bytes of the packet, except the start delimiter 0x7E and the length (the second and third bytes).
2. Keep only the lowest 8 bits from the result.
3. Subtract this quantity from 0xFF.

To verify the checksum of an API frame:

1. Add all bytes including the checksum; do not include the delimiter and length.
2. If the checksum is correct, the last two digits on the far right of the sum equal 0xFF.

### Example

Consider the following sample data packet: **7E 00 0A 01 01 50 01 00 48 65 6C 6C 6F B8+**

Byte(s)	Description
7E	Start delimiter
00 0A	Length bytes
01	API identifier
01	API frame ID
50 01	Destination address low

Byte(s)	Description
00	Option byte
48 65 6C 6C 6F	Data packet
B8	Checksum

To calculate the check sum you add all bytes of the packet, excluding the frame delimiter **7E** and the length (the second and third bytes):

**7E 00 0A 01 01 50 01 00 48 65 6C 6C 6F B8**

Add these hex bytes:

Now take the result of 0x247 and keep only the lowest 8 bits which in this example is 0xC4 (the two far right digits). Subtract 0x47 from 0xFF and you get 0x3B (0xFF - 0xC4 = 0x3B). 0x3B is the checksum for this data packet.

If an API data packet is composed with an incorrect checksum, the XBee 868LP RF Module will consider the packet invalid and will ignore the data.

To verify the check sum of an API packet add all bytes including the checksum (do not include the delimiter and length) and if correct, the last two far right digits of the sum will equal FF.

$01 + 01 + 50 + 01 + 00 + 48 + 65 + 6C + 6C + 6F + B8 = 2FF$

## API frame exchanges

### AT commands

The following image shows the API frame exchange that takes place at the UART when you send a 0x08 AT Command Request or 0x09 AT Command-Queue Request to read or set a device parameter. To disable the 0x88 AT Command Response, set the frame ID to 0 in the request.

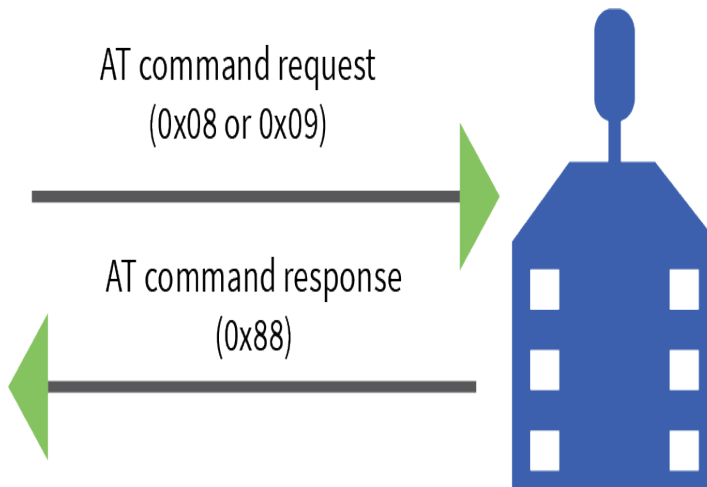

### Transmit and Receive RF data

The following image shows the API frames exchange that take place at the UART interface when sending RF data to another device. The transmit status frame is always sent at the end of a data transmission unless the frame ID is set to 0 in the TX request. If the packet cannot be delivered to the destination, the transmit status frame indicates the cause of failure.

The received data frame type (0x90 or 0x91) is determined by the **AO** command.



### Remote AT commands

The following image shows the API frame exchanges that take place at the serial interface when sending a remote AT command. The device does not send out a remote command response frame through the serial interface if the remote device does not receive the remote command.

### Device Registration

The following image shows the API frame exchanges that take place at the serial interface when registering a joining device to a trust center.

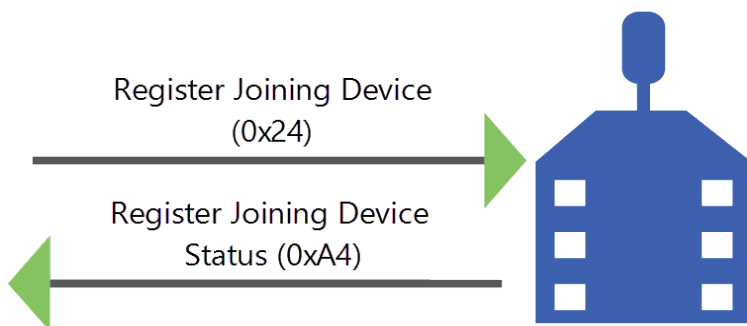

### Code to support future API frames

If your software application supports the API, you should make provisions that allow for new API frames in future firmware releases. For example, you can include the following section of code on a host microprocessor that handles serial API frames that are sent out the device's DOUT pin:

---

```
void XBee_HandleRxAPIFrame(_apiFrameUnion *papiFrame){
    switch(papiFrame->api_id){
        case RX_RF_DATA_FRAME:
            //process received RF data frame
            break;

        case RX_IO_SAMPLE_FRAME:
            //process IO sample frame
            break;

        case NODE_IDENTIFICATION_FRAME:
            //process node identification frame
            break;
    }
}
```

---

---

```

        default:
            //Discard any other API frame types that are not being used
            break;
    }
}

```

---

## Frame data

This field contains the information that a device receives or will transmit. The structure of frame data depends on the purpose of the API frame:

Start delimiter	Length		Frame data								Checksum
			Frame type	Data							
1	2	3	4	5	6	7	8	9	...	n	n+1
0x7E	MSB	LSB	API frame type	Data							Single byte

- **Frame type** is the API frame type identifier. It determines the type of API frame and indicates how the Data field organizes the information.
- **Data** contains the data itself. This information and its order depend on the what type of frame that the Frame type field defines.

Multi-byte values are sent big-endian.

## AT Command frame - 0x08

### Description

Use this frame to query or set device parameters on the local device. This API command applies changes after running the command. You can query parameter values by sending the 0x08 AT Command frame with no parameter value field (the two-byte AT command is immediately followed by the frame checksum).

### Format

The following table provides the contents of the frame. For details on frame structure, see [API frame format](#).

Frame data fields	Offset	Description
Frame type	3	0x08
AT command	5-6	Command name: two ASCII characters that identify the AT command.
Parameter value		If present, indicates the requested parameter value to set the given register. If no characters are present, it queries the register.

### Example

The following example illustrates an AT Command frame when you query the device's **NH** parameter value.

Frame data fields	Offset	Example
Start delimiter	0	0x7E
Length	MSB 1	0x00
	LSB 2	0x04
Frame type	3	0x08
Frame ID	4	0x52 (R)
AT command	5	0x4E (N)
	6	0x48 (H)
Parameter value (optional)		
Checksum	7	0x0F

## AT Command - Queue Parameter Value frame - 0x09

### Description

This frame allows you to query or set device parameters. In contrast to the AT Command (0x08) frame, this frame queues new parameter values and does not apply them until you issue either:

- The **AT** Command (0x08) frame (for API type)
- The **AC** command

### Format

The following table provides the contents of the frame. For details on frame structure, see [API frame format](#).

Frame data fields	Offset	Description
Frame type	3	0x09
Frame ID	4	Identifies the data frame for the host to correlate with a subsequent ACK. If set to <b>0</b> , the device does not send a response.
AT command	5-6	Command name: two ASCII characters that identify the AT command.
Parameter value	7-n	If present, indicates the requested parameter value to set the given register. If no characters are present, queries the register.

### Example

The following example sends a command to change the baud rate (**BD**) to 115200 baud, but does not apply the changes immediately. The device continues to operate at the previous baud rate until you apply the changes.

**Note** In this example, you could send the parameter as a zero-padded 2-byte or 4-byte value.

Frame data fields		
Start delimiter	0	0x7E
Length	MSB 1	0x00
	LSB 2	0x05
Frame type	3	0x09
Frame ID	4	0x01

Frame data fields		
AT command	5	0x42 (B)
	6	0x44 (D)
Parameter value ( <b>BD7</b> = 115200 baud)		0x07
Checksum	8	0x68



## Transmit Request frame - 0x10

### Description

This frame causes the device to send payload data as an RF packet to a specific destination.

- For broadcast transmissions, set the 64-bit destination address to **0x000000000000FFFF** for all devices.
- For unicast transmissions, set the 64 bit address field to the address of the desired destination node.
- Set the reserved field to **0xFFFE**.

### Format

The following table provides the contents of the frame. For details on the frame structure, see [API frame format](#).

Frame data fields	Offset	Description
Frame type	3	0x10
Frame ID	4	Identifies the data frame for the host to correlate with a subsequent ACK. If set to <b>0</b> , the device does not send a response.
64-bit destination address	5-12	MSB first, LSB last. Set to the 64-bit address of the destination device. Broadcast = 0x000000000000FFFF
Reserved	13-14	Set to 0xFFFE.
Broadcast radius	15	Sets the maximum number of hops a broadcast transmission can occur. If set to 0, the broadcast radius is set to the maximum hops value.
Transmit options	16	See the following Transmit Options table.
RF data	17-n	Up to <b>NP</b> bytes per packet. Sent to the destination device.

### Transmit Options bit field

**Bit field:**

Bit	Meaning	Description
0	Disable ACK	Disable acknowledgments on all unicasts.
1	Disable RD	Disable Route Discovery.

Bit	Meaning	Description
2	NACK	Enable unicast NACK messages.
3	Trace route	Enable unicast trace route messages.
6,7	Delivery method	b'00 = <invalid option> b'01 - Point-multipoint b'10 = Repeater mode (directed broadcast) b'11 = DigiMesh (not available on the 10k product)

## Example

The example shows how to send a transmission to a device if you disable escaping (**AP** = 1), with destination address 0x0013A200 40014011, and payload "TxData0A".

Frame data fields	Offset	Example
Start delimiter	0	0x7E
Length	MSB 1	0x00
	LSB 2	0x16
Frame type	3	0x10
Frame ID	4	0x01
64-bit destination address	MSB 5	0x00
	6	0x13
	7	0xA2
	8	0x00
	9	0x40
	10	0x0A
	11	0x01
	LSB 12	0x27
Reserved	MSB 13	0xFF
	LSB 14	0xFE
Broadcast radius	15	0x00
Options	16	0x40

Frame data fields	Offset	Example
RF data	17	0x54
	18	0x78
	19	0x44
	20	0x61
	21	0x74
	22	0x61
	23	0x30
	24	0x41
Checksum	25	0x13

If you enable escaping (**AP** = 2), the frame should look like:

```
0x7E 0x00 0x16 0x10 0x01 0x00 0x7D 0x33 0xA2 0x00 0x40 0x0A 0x01 0x27 0xFF 0xFE 0x00
0x00 0x54 0x78 0x44 0x61 0x74 0x61 0x30 0x41 0x7D 0x33
```

The device calculates the checksum (on all non-escaped bytes) as [0xFF - (sum of all bytes from API frame type through data payload)].

## Explicit Addressing Command frame - 0x11

### Description

This frame is similar to Transmit Request (0x10), but it also requires you to specify the application-layer addressing fields: endpoints, cluster ID, and profile ID.

This frame causes the device to send payload data as an RF packet to a specific destination, using specific source and destination endpoints, cluster ID, and profile ID.

- For broadcast transmissions, set the 64-bit destination address to **0x000000000000FFFF** for all devices.
- For unicast transmissions, set the 64 bit address field to the address of the desired destination node.
- For all other transmissions, setting the 16-bit address to the correct 16-bit address helps improve performance when transmitting to multiple destinations. If you do not know a 16-bit address, set this field to 0xFFFE (unknown). If successful, the Transmit Status frame (0x8B) indicates the discovered 16-bit address.
- Set the reserved field to **0xFFFE**.

You can set the broadcast radius from 0 up to **NH** to 0xFF. If the broadcast radius exceeds the value of **NH**, the devices uses the value of **NH** as the radius. This parameter is only used for broadcast transmissions.

You can read the maximum number of payload bytes with the **NP** command.

### Format

The following table provides the contents of the frame. For details on the frame structure, see [API frame format](#).

Frame data fields	Offset	Description
Frame type	3	0x11
Frame ID	4	Identifies the data frame for the host to correlate with a subsequent ACK. If set to <b>0</b> , the device does not send a response.
64-bit destination address	5-12	MSB first, LSB last. Set to the 64-bit address of the destination device. Broadcast = 0x000000000000FFFF
Reserved	13-14	Set to 0xFFFE.
Source endpoint	15	Source endpoint for the transmission.
Destination endpoint	16	Destination endpoint for the transmission.
Cluster ID	17-18	The Cluster ID that the host uses in the transmission.
Profile ID	19-20	The Profile ID that the host uses in the transmission.

Frame data fields	Offset	Description
Broadcast radius	21	Sets the maximum number of hops a broadcast transmission can traverse. If set to 0, the transmission radius set to the network maximum hops value.
Transmission options	22	Bitfield: bits 6,7: b'01 - Point-to-Multipoint b'10 - Repeater mode (directed broadcast) b'11 - DigiMesh (not available on 10k product) All other bits must be set to 0.
Data payload	23-n	

## Example

The following example sends a data transmission to a device with:

- 64-bit address: 0x00
- Source endpoint: 0xA0
- Destination endpoint: 0xA1
- Cluster ID: 0x1554
- Profile ID: 0xC105
- Payload: TxData

Frame data fields	Offset	Example
Start delimiter	0	0x7E
Length	MSB 1	0x00
	LSB 2	0x1A
Frame type	3	0x11
Frame ID	4	0x01
64-bit destination address	MSB 5	0x00
	6	0x13
	7	0xA2
	8	0x00
	9	0x01
	10	0x23
	11	0x84
	LSB12	0x00

Frame data fields	Offset	Example
Reserved	MSB 13	0xFF
	LSB 14	0xFE
Source endpoint	15	0xA0
Destination endpoint	16	0xA1
Cluster ID	17	0x15
	18	0x54
Profile ID	19	0xC1
	20	0x05
Broadcast radius	21	0x00
Transmit options	22	0x00
Data payload	23	0x54
	24	0x78
	25	0x44
	26	0x61
	27	0x74
	28	0x61
Checksum	29	0xDD

## Remote AT Command Request frame - 0x17

### Description

Used to query or set device parameters on a remote device. For parameter changes on the remote device to take effect, you must apply changes, either by setting the Apply Changes options bit, or by sending an **AC** command to the remote.

### Format

The following table provides the contents of the frame. For details on frame structure, see [API frame format](#).

Frame data fields	Offset	Description
Frame type	3	0x17
Frame ID	4	Identifies the UART data frame for the host to correlate with a subsequent ACK. If set to <b>0</b> , the device does not send a response.
64-bit destination address	5-12	MSB first, LSB last. Set to the 64-bit address of the destination device. Broadcast = 0x000000000000FFFF.
Reserved	13-14	Set to 0xFFFE.
Remote command options	15	0x02 = Apply changes on remote. If you do not set this, you must send the <b>AC</b> command for changes to take effect. Set all other bits to 0.
AT command	16-17	Command name: two ASCII characters that identify the command.
Command parameter	18-n	If present, indicates the parameter value you request for a given register. If no characters are present, it queries the register.

### Example

The following example sends a remote command:

- Change the broadcast hops register on a remote device to 1 (broadcasts go to 1-hop neighbors only).
- Apply changes so the new configuration value takes effect immediately.

In this example, the 64-bit address of the remote device is 0x0013A200 40401122.

Frame data fields	Offset	Example
Start delimiter	0	0x7E

Frame data fields	Offset	Example
Length	MSB 1	0x00
	LSB 2	0x10
Frame type	3	0x17
Frame ID	4	0x01
64-bit destination address	MSB 5	0x00
	6	0x13
	7	0xA2
	8	0x00
	9	0x40
	10	0x40
	11	0x11
	LSB 12	0x22
Reserved	13	0xFF
	14	0xFE
Remote command options	15	0x02 (apply changes)
AT command	16	0x42 (B)
	17	0x48 (H)
Command parameter	18	0x01
Checksum	19	0xF5



## AT Command Response frame - 0x88

### Description

A device sends this frame in response to an AT Command (0x08 or 0x09) frame. Some commands send back multiple frames; for example, the **ND** command.

### Format

The following table provides the contents of the frame. For details on frame structure, see [API frame format](#).

The following table provides the contents of the frame. For details on frame structure, see [API frame format](#).

Frame data fields	Offset	Description
Frame type	3	0x88
Frame ID	4	Identifies the serial port data frame being reported. If Frame ID = 0 in Command mode, the device does not give an AT Command Response.
AT command	5-6	Command name: two ASCII characters that identify the command.
Command status	7	0 = OK 1 = ERROR 2 = Invalid command 3 = Invalid parameter The most significant nibble is a bitfield as follows: 0x40 = The RSSI field is invalid and should be ignored. Software prior to version 8x60 did not include RSSI information. 0x80 = Response is a remote command.
Command data		The register data in binary format. If the host sets the register, the device does not return this field.

### Example

If you change the **BD** parameter on a local device with a frame ID of 0x01, and the parameter is valid, the user receives the following response.

Frame data fields	Offset	Example
Start delimiter	0	0x7E

Frame data fields	Offset	Example
Length	MSB 1	0x00
	LSB 2	0x05
Frame type	3	0x88
Frame ID	4	0x01
AT command	5	0x42 (B)
	6	0x44 (D)
Command status	7	0x00
Command data		(No command data implies the parameter was set rather than queried)
Checksum	8	0xF0

## Modem Status frame - 0x8A

### Description

Devices send the status messages in this frame in response to specific conditions.

### Format

The following table provides the contents of the frame. For details on frame structure, see [API frame format](#).

Frame data fields	Offset	Description
Frame type	3	0x8A
Status	4	0x00 = Hardware reset 0x01 = Watchdog timer reset 0x0B = Network woke up 0x0C = Network went to sleep

### Example

When a device powers up, it returns the following API frame.

Frame data fields	Offset	Example
Start delimiter	0	0x7E
Length	MSB 1	0x00
	LSB 2	0x02
Frame type	3	0x8A
Status	4	0x00
Checksum	5	0x75

## Transmit Status frame - 0x8B

### Description

When a Transmit Request (0x10, 0x11) completes, the device sends a Transmit Status message out of the serial interface. This message indicates if the Transmit Request was successful or if it failed.

**Note** Broadcast transmissions are not acknowledged and always return a status of 0x00, even if the delivery failed.

### Format

The following table provides the contents of the frame. For details on frame structure, see [API frame format](#).

Frame data fields	Offset	Description
Frame type	3	0x8B
Frame ID	4	Identifies the serial interface data frame being reported. If Frame ID = 0 in the associated request frame, no response frame is delivered.
Reserved	5-6	Set to 0xFFFE.
Transmit retry count	7	The number of application transmission retries that occur.
Delivery status	8	0x00 = Success 0x01 = MAC ACK failure 0x02 = LBT Failure 0x03 = No Spectrum Available 0x21 = Network ACK failure 0x25 = Route not found 0x74 = Payload too large 0x75 = Indirect message requested
Discovery status	9	0x00 = No discovery overhead 0x02 = Route discovery

### Example

In the following example, the destination device reports a successful unicast data transmission. The outgoing Transmit Request that this response frame uses Frame ID of 0x47.

Frame Fields	Offset	Example
Start delimiter	0	0x7E

Frame Fields	Offset	Example
Length	MSB 1	0x00
	LSB 2	0x07
Frame type	3	0x8B
Frame ID	4	0x47
Reserved	5	0xFF
	6	0xFE
Transmit retry count	7	0x00
Delivery status	8	0x00
Discovery status	9	0x02
Checksum	10	0x2E

## Route Information Packet frame - 0x8D

### Description

If you enable NACK or the Trace Route option on a DigiMesh unicast transmission, a device can output this frame for the transmission.

### Format

The following table provides the contents of the frame. For details on frame structure, see [API frame format](#).

Frame data fields	Offset	Description
Frame type	3	0x8D
Source event	4	0x11 = NACK 0x12 = Trace route
Length	5	The number of bytes that follow, excluding the checksum. If the length increases, new items have been added to the end of the list for future revisions.
Timestamp	6-9	MSB first, LSB last. System timer value on the node generating the Route Information Packet.
ACK timeout count	10	The number of MAC ACK timeouts that occur.
TX blocked count	11	The number of times the transmission was blocked due to reception in progress.
Reserved	12	Reserved, set to 0s.
Destination address	13-20	MSB first, LSB last. The address of the final destination node of this network-level transmission.
Source address	21-28	MSB first, LSB last. Address of the source node of this network-level transmission.
Responder address	29-36	MSB first, LSB last. Address of the node that generates this Route Information packet after it sends (or attempts to send) the packet to the next hop (the Receiver node).
Receiver address	37-44	MSB first, LSB last. Address of the node that the device sends (or attempts to send) the data packet.

### Example

The following example represents a possible Route Information Packet. A device receives the packet when it performs a trace route on a transmission from one device (serial number 0x0013A200 4052AAAA) to another (serial number 0x0013A200 4052DDDD).

This particular frame indicates that the network successfully forwards the transmission from one device (serial number 0x0013A200 4052BBBB) to another device (serial number 0x0013A200 4052CCCC).

Frame data fields	Offset	Example
Start delimiter	0	0x7E
Length	MSB 1	0x00
	LSB 2	0x2A
Frame type	3	0x8D
Source event	4	0x12
Length	5	0x2B
Timestamp	MSB 6	0x9C
	7	0x93
	8	0x81
	LSB 9	0x7F
ACK timeout count	10	0x00
TX blocked count	11	0x00
Reserved	12	0x00
Destination address	MSB 13	0x00
	14	0x13
	15	0xA2
	16	0x00
	17	0x40
	18	0x52
	19	0xAA
	LSB 20	0xAA

Frame data fields	Offset	Example
Source address	MSB 21	0x00
	22	0x13
	23	0xA2
	24	0x00
	25	0x40
	26	0x52
	27	0xDD
	LSB 28	0xDD
Responder address	MSB 29	0x00
	30	0x13
	31	0xA2
	32	0x00
	33	0x40
	34	0x52
	35	0xBB
	LSB 36	0xBB
Receiver address	MSB 37	0x00
	38	0x13
	39	0xA2
	40	0x00
	41	0x40
	42	0x52
	43	0xCC
	LSB 44	0xCC
Checksum	45	0xCE



## Aggregate Addressing Update frame - 0x8E

### Description

The device sends out an Aggregate Addressing Update frame on the serial interface of an API-enabled node when an address update frame (generated by the **AG** command being issued on a node in the network) causes the node to update its **DH** and **DL** registers.

### Format

The following table provides the contents of the frame. For details on frame structure, see [API frame format](#).

Frame data fields	Offset	Description
Frame type	3	0x8E
Format ID	4	Byte reserved to indicate the format of additional packet information which may be added in future firmware revisions. In the current firmware revision, this field returns 0x00.
New address	5-12	MSB first, LSB last. Address to which <b>DH</b> and <b>DL</b> are being set.
Old address	13-20	Address to which <b>DH</b> and <b>DL</b> were previously set.

### Example

In the following example, a device with destination address (**DH/DL**) of 0x0013A200 4052AAAA updates its destination address to 0x0013A200 4052BBBB.

Frame data fields	Offset	Example
Start delimiter	0	0x7E
Length	MSB 1	0x00
	LSB 2	0x12
Frame type	3	0x8E
Format ID	4	0x00

Frame data fields	Offset	Example
New address	MSB 5	0x00
	6	0x13
	7	0xA2
	8	0x00
	9	0x40
	10	0x52
	11	0xBB
	LSB 12	0xBB
Old address	13	0x00
	14	0x13
	15	0xA2
	16	0x00
	17	0x40
	18	0x52
	19	0xAA
	20	0xAA
Checksum	21	0x2E

## Receive Packet frame - 0x90

### Description

When a device configured with a standard API Rx Indicator (**AO = 0**) receives an RF data packet, it sends it out the serial interface using this message type.

### Format

The following table provides the contents of the frame. For details on frame structure, see [API frame format](#).

Frame data fields	Offset	Description
Frame type	3	0x90
64-bit source address	4-11	The sender's 64-bit address. MSB first, LSB last.
Reserved	12-13	Reserved.
Receive options	14	Bit field: 0x00 = Packet acknowledged 0x01 = Packet was a broadcast packet 0x06, 0x07:  b'01 = Point-Multipoint b'10 = Repeater mode (directed broadcast) b'11 = DigiMesh (not available on the 10K product)  Ignore all other bits.
Received data	15-n	The RF data the device receives.

### Example

In the following example, a device with a 64-bit address of 0x0013A200 40522BAA sends a unicast data transmission to a remote device with payload RxData. If **AO=0** on the receiving device, it sends the following frame out its serial interface.

Frame data fields	Offset	Example
Start delimiter	0	0x7E
Length	MSB 1	0x00
	LSB 2	0x12
Frame type	3	0x90

Frame data fields	Offset	Example
64-bit source address	MSB 4	0x00
	5	0x13
	6	0xA2
	7	0x00
	8	0x40
	9	0x52
	10	0x2B
	LSB 11	0xAA
Reserved	12	0xFF
	13	0xFE
Receive options	14	0x01
Received data	15	0x52
	16	0x78
	17	0x44
	18	0x61
	19	0x74
	20	0x61
Checksum	21	0x11

## Explicit Rx Indicator frame - 0x91

### Description

When a device configured with explicit API Rx Indicator (**AO = 1**) receives an RF packet, it sends it out the serial interface using this message type.

**Note** If a [Transmit Request frame - 0x10](#) is sent to a device with **AO = 1**, the receiving device receives a 0x91 frame with the Source endpoint (SE), Destination endpoint (DE), and Cluster ID (CI) that were set on the transmitting device in Transparent mode, and not the default values.

The Cluster ID and endpoints must be used to identify the type of transaction that occurred.

### Format

The following table provides the contents of the frame. For details on frame structure, see [API frame format](#).

Frame data fields	Offset	Description
Frame type	3	0x91
64-bit source address	4-11	MSB first, LSB last. The sender's 64-bit address.
Reserved	12-13	Reserved.
Source endpoint	14	Endpoint of the source that initiates transmission.
Destination endpoint	15	Endpoint of the destination where the message is addressed.
Cluster ID	16-17	The Cluster ID where the frame is addressed.
Profile ID	18-19	The Profile ID where the fame is addressed.
Receive options	20	Bit field: 0x00 = Packet acknowledged 0x01 = Packet was a broadcast packet 0x06, 0x07:  b'01 = Point-Multipoint b'10 = Repeater mode (directed broadcast) b'11 = DigiMesh (not available on the 10K product)  Ignore all other bits.
Received data	21-n	Received RF data.

### Example

In the following example, a device with a 64-bit address of 0x0013A200 40522BAA sends a broadcast data transmission to a remote device with payload RxData.

If a device sends the transmission:

- With source and destination endpoints of 0xE0
- Cluster ID = 0x2211
- Profile ID = 0xC105

If **AO = 1** on the receiving device, it sends the following frame out its serial interface.

Frame data fields	Offset	Example
Start delimiter	0	0x7E
Length	MSB 1	0x00
	LSB 2	0x18
Frame type	3	0x91
64-bit source address	MSB 4	0x00
	5	0x13
	6	0xA2
	7	0x00
	8	0x40
	9	0x52
	10	0x2B
	LSB 11	0xAA
Reserved	12	0xFF
	13	0xFE
Source endpoint	14	0xE0
Destination endpoint	15	0xE0
Cluster ID	16	0x22
	17	0x11
Profile ID	18	0xC1
	19	0x05
Receive options	20	0x02

Frame data fields	Offset	Example
Received data	21	0x52
	22	0x78
	23	0x44
	24	0x61
	25	0x74
	26	0x61
Checksum	27	0x56

## Data Sample Rx Indicator frame - 0x92

### Description

When you enable periodic I/O sampling or digital I/O change detection on a remote device, the UART of the device that receives the sample data sends this frame out.

### Format

The following table provides the contents of the frame. For details on frame structure, see [API frame format](#).

Frame data fields	Offset	Description
Frame type	3	0x92
64-bit source address	4-11	The sender's 64-bit address.
Reserved	12-13	Reserved.
Receive options	14	Bit field: 0x01 = Packet acknowledged 0x02 = Packet is a broadcast packet Ignore all other bits
Number of samples	15	The number of sample sets included in the payload. Always set to 1.
Digital channel mask	16-17	Bitmask field that indicates which digital I/O lines on the remote have sampling enabled, if any.
Analog channel mask	18	Bitmask field that indicates which analog I/O lines on the remote have sampling enabled, if any.
Digital samples (if included)	19-20	If the sample set includes any digital I/O lines (Digital channel mask > 0), these two bytes contain samples for all enabled digital I/O lines. DIO lines that do not have sampling enabled return 0. Bits in these two bytes map the same as they do in the Digital channel mask field.

Frame data fields	Offset	Description
Analog sample	21-n	If the sample set includes any analog I/O lines (Analog channel mask > 0), each enabled analog input returns a 2-byte value indicating the A/D measurement of that input. Analog samples are ordered sequentially from ADO/DIO0 to AD3/DIO3.

## Example

In the following example, the device receives an I/O sample from a device with a 64-bit serial number of 0x0013A20040522BAA.

The configuration of the transmitting device takes a digital sample of a number of digital I/O lines and an analog sample of AD1. It reads the digital lines to be 0x0014 and the analog sample value is 0x0225.

The complete example frame is:

```
7E00 1492 0013 A200 4052 2BAA FFFE 0101 001C 0200 1402 25F9
```

Frame fields	Offset	Example
Start delimiter	0	0x7E
Length	MSB 1	0x00
	LSB 2	0x14
Frame-specific data		
64-bit source address	MSB 4	0x00
	5	0x13
	6	0xA2
	7	0x00
	8	0x40
	9	0x52
	10	0x2B
	LSB 11	0xAA
Reserved	MSB 12	0xfffe
	LSB 13	0x84
Receive options	14	0x01
Number of samples	15	0x01
Digital channel mask	16	0x00
	17	0x1C
Analog channel mask	18	0x02



Frame fields	Offset	Example
Digital samples (if included)	19	0x00
	20	0x14
Analog sample	21	0x02
	22	0x25
Checksum	23	0xF5

## Node Identification Indicator frame - 0x95

### Description

A device receives this frame when:

- it transmits a node identification message to identify itself
- **AO = 0**

The data portion of this frame is similar to a network discovery response. For more information, see [ND \(Network Discover\)](#).

If you press the commissioning push button on a remote router device with 64-bit address 0x0013a200407402ac and default **NI** string, the device receives the following node identification indicator:

```
0x7e 0025 9500 13a2 0040 7402 acff fec2 ffe0 0013 a200 4074 02ac 2000 ffe0 0101 c105 101e 000c
0000 2e33
```

### Format

The following table provides the contents of the frame. For details on frame structure, see [API frame format](#).

Frame data fields	Offset	Description
Frame type	3	0x95
64-bit source address	4-11	MSB first, LSB last. The sender's 64-bit address.
Reserved	12-13	Reserved.
Receive options	14	Bit field: 0x01 = Packet acknowledged 0x02 = Packet was a broadcast packet 0x40 = Point-multipoint packet 0x80 = Directed broadcast packet 0xC0 = DigiMesh packet Ignore all other bits
Reserved	15-16	Reserved.
64-bit remote address	17-24	MSB first, LSB last. Indicates the 64-bit address of the remote device that transmitted the Node Identification Indicator frame.
NI string	25-26	Node identifier string on the remote device. The NI string is terminated with a NULL byte (0x00).
Reserved	27-28	Reserved.

Frame data fields	Offset	Description
Device type	29	0 = Coordinator 1 = Normal Mode 2 = End Device For more options, see <a href="#">NO (Node Discovery Options)</a> .
Source event	30	1 = Frame sent by node identification pushbutton event.
Digi Profile ID	31-32	Set to the Digi application profile ID.
Digi Manufacturer ID	33-34	Set to the Digi Manufacturer ID.
Digi DD value (optional)	35-38	Reports the <b>DD</b> value of the responding device. Use the <b>NO</b> command to enable this field.
RSSI (optional)	39	Received signal strength indicator. Use the <b>NO</b> command to enable this field.

## Example

```
0x7e 0025 9500 13a2 0040 7402 acff fec2 fffe 0013 a200 4074 02ac 2000 fffe 0101
c105 101e
```

Frame data fields	Offset	Example
Start delimiter	0	0x7E
Length	MSB 1	0x00
	LSB 2	0x25
Frame type	3	0x95
64-bit source address	MSB 4	0x00
	5	0x13
	6	0xA2
	7	0x00
	8	0x40
	9	0x74
	10	0x02
	LSB 11	0xAC
Reserved	12	0xFF
	13	0xFE

Frame data fields	Offset	Example
Receive options	14	0xC2
Reserved	15	0xFF
	16	0xFE
64-bit remote address	MSB 17	0x00
	18	0x13
	19	0xA2
	20	0x00
	21	0x40
	22	0x74
	23	0x02
	LSB 24	0xAC
NI string	25	0x20
	26	0x00
Reserved	27	0xFF
	28	0xFE
Device type	29	0x01
Source event	30	0x01
Digi Profile ID	31	0xC1
	32	0x05
Digi Manufacturer ID	33	0x10
	34	0x1E
Digi DD value (optional)	35	0x00
	36	0x0C
	37	0x00
	38	0x00
RSSI (optional)	39	0x2E
Checksum	40	0x33

## Remote Command Response frame - 0x97

### Description

If a device receives this frame in response to a Remote Command Request (0x17) frame, the device sends an AT Command Response (0x97) frame out the serial interface.

Some commands, such as the **ND** command, may send back multiple frames. For details on the behavior of **ND**, see [ND \(Network Discover\)](#).

### Format

The following table provides the contents of the frame. For details on frame structure, see [API frame format](#).

Frame data fields	Offset	Description
Frame type	3	0x97
Frame ID	4	This is the same value passed in to the request. If Frame ID = 0 in the associated request frame the device does not deliver a response frame.
64-bit source (remote) address	5-12	The address of the remote device returning this response.
Reserved	13-14	Reserved.
AT commands	15-16	The name of the command.
Command status	17	0 = OK 1 = ERROR 2 = Invalid Command 3 = Invalid Parameter 4 = No response The most significant nibble is a bit field as follows: 0x40 = The RSSI field is invalid and should be ignored. 0x80 = Response is a remote command
Command data	18-n	The value of the requested register.

### Example

If a device sends a remote command to a remote device with 64-bit address 0x0013A200 40522BAA to query the **SL** command, and if the frame ID = 0x55, the response would look like the following example.

Frame data fields	Offset	Example
Start delimiter	0	0x7E

Frame data fields	Offset	Example
Length	MSB 1	0x00
	LSB 2	0x13
Frame type	3	0x97
Frame ID	4	0x55
64-bit source (remote) address	MSB 5	0x00
	6	0x13
	7	0xA2
	8	0x00
	9	0x40
	10	0x52
	11	0x2B
	LSB 12	0xAA
Reserved	13	0xFF
	14	0xFE
AT commands	15	0x53
	16	0x4C
Command status	17	0x00
Command data	18	0x40
	19	0x52
	20	0x2B
	21	0xAA
Checksum	22	0xF4

## Migrate from XBee through-hole to surface-mount devices

---

We design the XBee surface-mount and through-hole devices to be compatible with each other and offer the same basic feature set. The surface-mount form factor has more I/O pins. Because the XBee device was originally offered in only the through-hole form factor, we offer this section to help you migrate from the through-hole to the surface-mount form factor.

Pin mapping .....	208
Mounting .....	209

## Pin mapping

XBee 868LP RF Module modules are designed to be compatible with the XBee through-hole modules. The SMT modules have all the features of the through-hole modules, and offer the increased feature set.

SMT Pin #	Name	TH Pin #
1	GND	
2	V <sub>DD</sub>	1
3	DO <sub>UT</sub> / DIO13	2
4	DI <sub>N</sub> / CONFIG / DIO14	3
5	DIO12	4
6	RESET	5
7	RSSI PWM / DIO10	6
8	PWM1 / DIO11	7
9	[reserved]	8
10	DTR / SLEEP_RQ / DIO8	9
11	GND	10
12	SPI_ATT <sub>N</sub> / DIO19	
13	GND	
14	SPI_CLK / DIO18	
15	SPI_SSEL / DIO17	
16	SPI_MOSI / DIO16	
17	SPI_MISO / DIO15	
18	[reserved]	
19	[reserved]	
20	[reserved]	
21	[reserved]	
22	GND	
23	[reserved]	
24	DIO4	11
25	CTS / DIO7	12
26	ON / SLEEP / DIO9	13



SMT Pin #	Name	TH Pin #
27	V <sub>REF</sub>	14
28	ASSOCIATE / DIO5	15
29	$\overline{\text{RTS}}$ / DIO6	16
30	AD3 / DIO3	17
31	AD2 / DIO2	18
32	AD1 / DIO1	19
33	AD0 / DIO0	20
34	[reserved]	
35	GND	
36	RF	
37	[reserved]	

## Mounting

One important difference between the surface-mount and the through-hole devices is how they mount to the PCB. Different mounting techniques are required.

We designed a footprint that allows either device to be attached to a PCB as shown in the following diagram. The dimensions without brackets are in inches, and those in brackets are in millimeters.

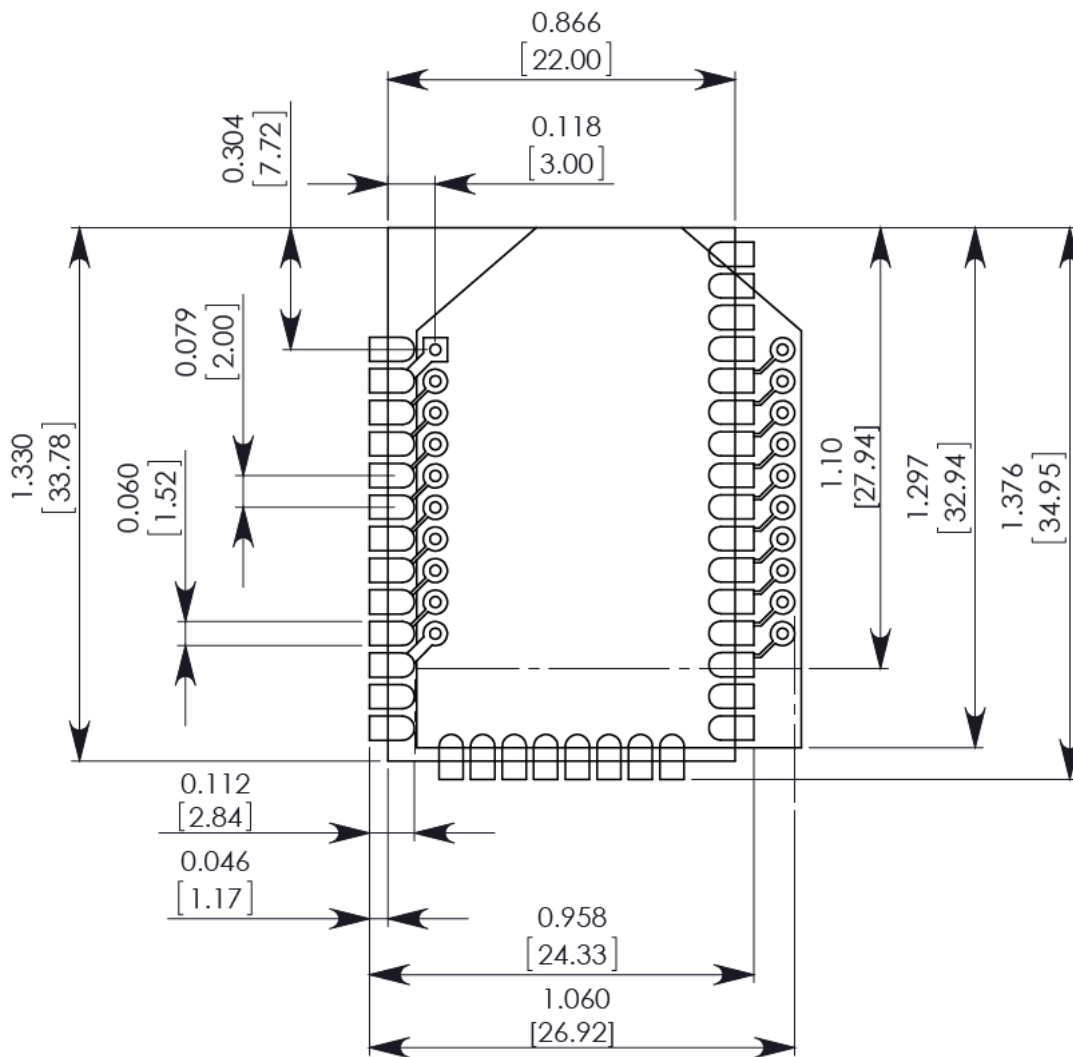

The round holes in the diagram are for the through-hole design, and the semi-oval pads are for the surface-mount design. Pin 1 of the through-hole design lines up with pad 1 of the surface-mount design, but the pins are actually offset by one pad (see [Pin mapping](#)). By using diagonal traces to connect the appropriate pins, the layout works for both modules.

For information on attaching the SMT device, see [Manufacturing information](#).

## Manufacturing information

---

The XBee 868LP RF Module is designed for surface-mounting on the OEM PCB. It has castellated pads to allow for easy solder attaching and inspection. The pads are all located on the edge of the device so there are no hidden solder joints on these devices.

Recommended solder reflow cycle .....	212
Recommended footprint .....	212
Flux and cleaning .....	214
Reworking .....	215

## Recommended solder reflow cycle

The following table lists the recommended solder reflow cycle. The chart shows the temperature setting and the time to reach the temperature.

Time (seconds)	Temperature (°C)
30	65
60	100
90	135
120	160
150	195
180	240
210	260

The maximum temperature should not exceed 260 °C.

The device reflows during this cycle, and must not be reflowed upside down. Be careful not to jar the device while the solder is molten, as parts inside the device can be removed from their required locations.

Hand soldering is possible and should be done in accordance with approved standards.

## Recommended footprint

We recommend that you use the following PCB footprints for surface-mounting. The dimensions without brackets are in inches, and those in brackets are in millimeters.

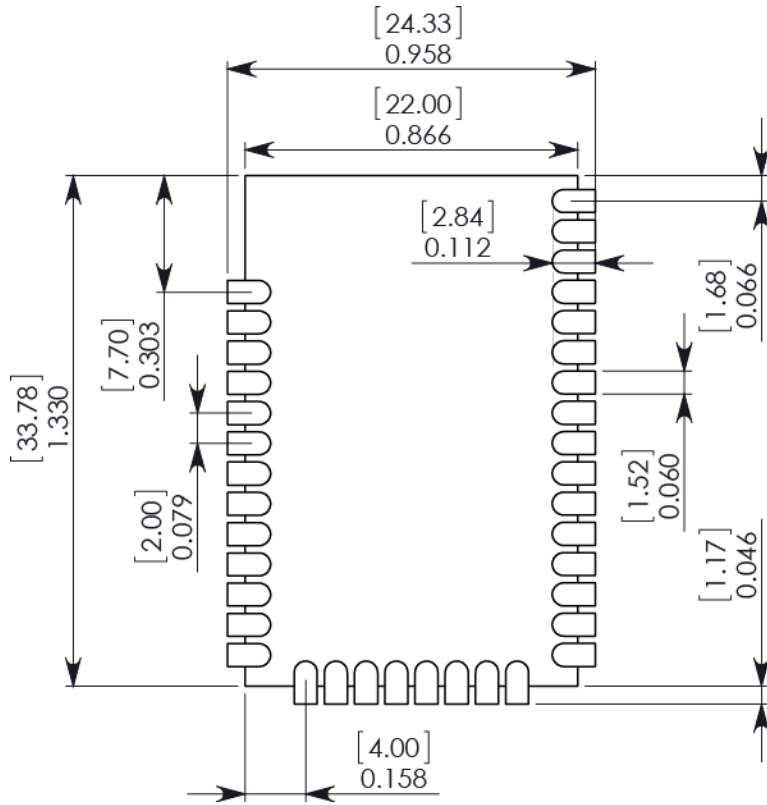

Match the solder footprint to the copper pads, but may need to be adjusted depending on the specific needs of assembly and product standards.

While the underside of the device is mostly coated with solder resist, we recommended the copper layer directly below the device be left open to avoid unintended contacts. Copper or vias must not interfere with the three exposed RF test points on the bottom of the device as shown in the following diagram. These devices have a ground plane in the middle on the back side for shielding purposes, which can be affected by copper traces directly below the device.

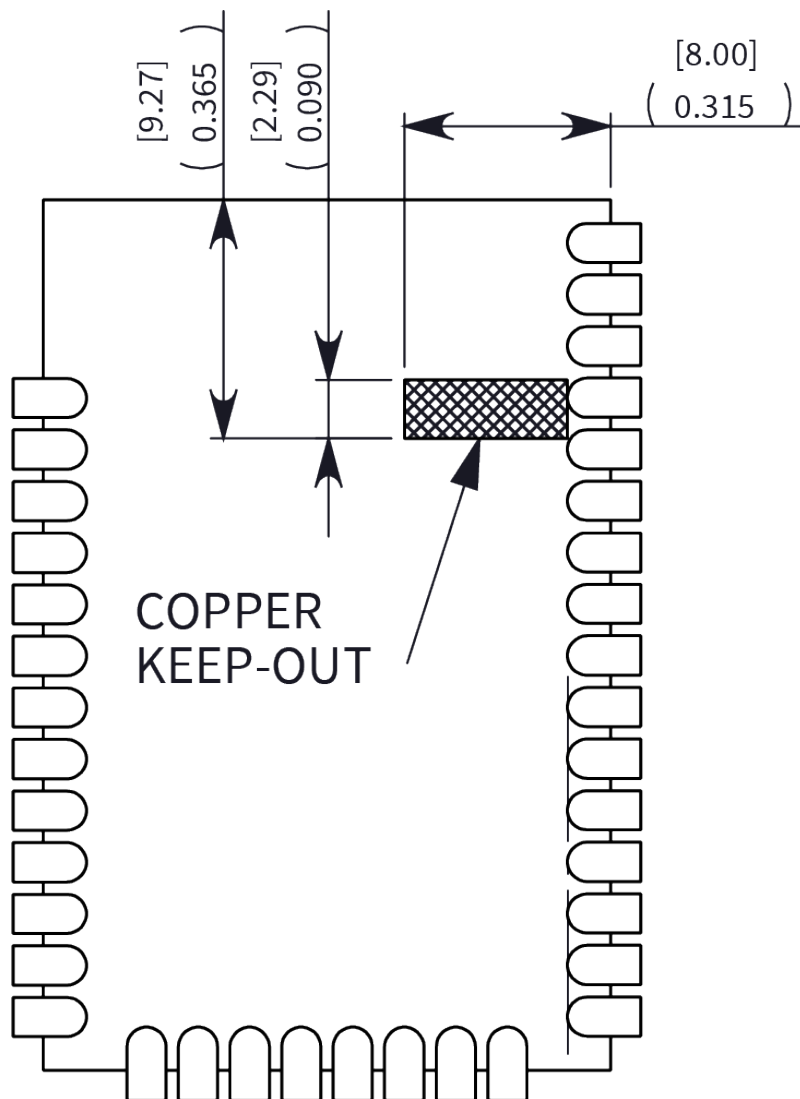

## Flux and cleaning

We recommend that you use a “no clean” solder paste in assembling these devices. This eliminates the clean step and ensures that you do not leave unwanted residual flux under the device where it is difficult to remove. In addition:

- Cleaning with liquids can result in liquid remaining under the device or in the gap between the device and the host PCB. This can lead to unintended connections between pads.
- The residual moisture and flux residue under the device are not easily seen during an inspection process.

---

**Note** The best practice is to use a “no clean” solder paste to avoid the issues above and ensure proper module operation.

---

## **Reworking**

Never perform rework on the device itself. The device has been optimized to give the best possible performance, and reworking the device itself will void warranty coverage and certifications. We recognize that some customers choose to rework and void the warranty. The following information serves as a guideline in such cases to increase the chances of success during rework, though the warranty is still voided.

The device may be removed from the OEM PCB by the use of a hot air rework station, or hot plate. Be careful not to overheat the device. During rework, the device temperature may rise above its internal solder melting point and care should be taken not to dislodge internal components from their intended positions.

## Regulatory information

---

Europe .....	217
Antennas .....	219



## Europe

The XBee 868LP RF Modules have been tested for use in several European countries. For a complete list, refer to [www.digi.com](http://www.digi.com).

If the XBee RF Modules are incorporated into a product, the manufacturer must ensure compliance of the final product with articles 3.1a and 3.1b of the EU Directive 2014/53/EU (Radio Equipment Directive). A Declaration of Conformity must be issued for each of these standards and kept on file as described in the RE Directive (Radio Equipment Directive).

Furthermore, the manufacturer must maintain a copy of the XBee user manual documentation and ensure the final product does not exceed the specified power ratings, antenna specifications, and/or installation requirements as specified in the user guide.

### Maximum power and frequency specifications

The maximum radiated RF power is 14 dBm.

The following table shows channel frequencies.

Channel number	Frequency
0	863.15 MHz
1	863.35 MHz
2	863.55 MHz
3	863.75 MHz
4	863.95 MHz
5	864.15 MHz
6	864.35 MHz
7	864.55 MHz
8	864.75 MHz
9	864.95 MHz
10	865.15 MHz
11	865.35 MHz
12	865.55 MHz
13	865.75 MHz
14	865.95 MHz
15	866.15 MHz
16	866.35 MHz
17	866.55 MHz
18	866.75 MHz

Channel number	Frequency
19	866.95 MHz
20	867.15 MHz
21	867.35 MHz
22	867.55 MHz
23	867.75 MHz
24	867.95 MHz
25	868.15 MHz
26	868.35 MHz
27	868.85 MHz
28	869.05 MHz
29	869.85 MHz

## OEM labeling requirements

The “CE” marking must be affixed to a visible location on the OEM product. The following figure shows CE labeling requirements.

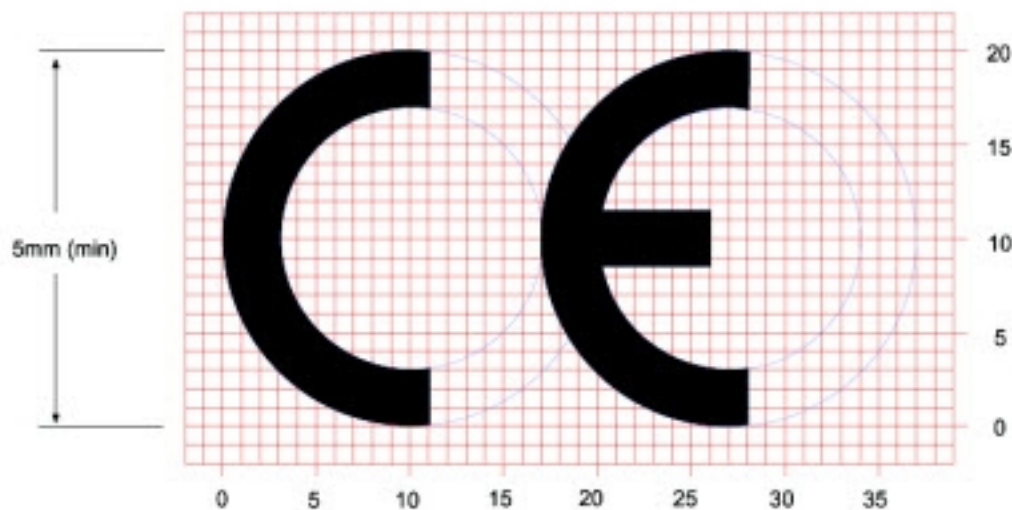

The CE mark shall consist of the initials “CE” taking the following form:

- If the CE marking is reduced or enlarged, the proportions given in the above graduated drawing must be respected.
- The CE marking must have a height of at least 5 mm except where this is not possible on account of the nature of the apparatus.
- The CE marking must be affixed visibly, legibly, and indelibly.

**Important note**

Digi customers assume full responsibility for learning and meeting the required guidelines for each country in their distribution market. Refer to the radio regulatory agency in the desired countries of operation for more information.

**Declarations of conformity**

Digi has issued Declarations of Conformity for the XBee RF Modules concerning emissions, EMC, and safety. For more information, see [www.digi.com/resources/certifications](http://www.digi.com/resources/certifications).

**Antennas**

The following antennas have been tested and approved for use with the XBee 868LP RF Module:

All antenna part numbers followed by an asterisk (\*) are not available from Digi. Consult with an antenna manufacturer for an equivalent option.

- Dipole (2.1 dBi), Digi PN A08-HABUF-P5I\*
- PCB Antenna (-9 dBi), included with the module