

**General Description**

The MAX14900E octal high-speed, industrial, high-side switch evaluation kit (EV kit) is a fully assembled and tested surface-mount printed circuit board (PCB) that demonstrates the capabilities of the MAX14900E IC to drive industrial-grade signals.

This EV kit demonstrates operation in all MAX14900E modes. In parallel mode, jumpers allow for arbitrary configuration. In serial mode, or parallel mode with serial monitoring, attach a control circuit to the appropriate test points, as detailed below.

**Features**

- Stand-Alone Operation in Parallel Mode
- SPI-Controlled for Serial Mode/Monitored-Parallel Mode
- Built-In 5V Regulator
- Surge-Compliance Clamp Diodes Included
- Fully Assembled and Tested

*Ordering Information appears at end of data sheet.*

**MAX14900E EV Kit PCB Photo**

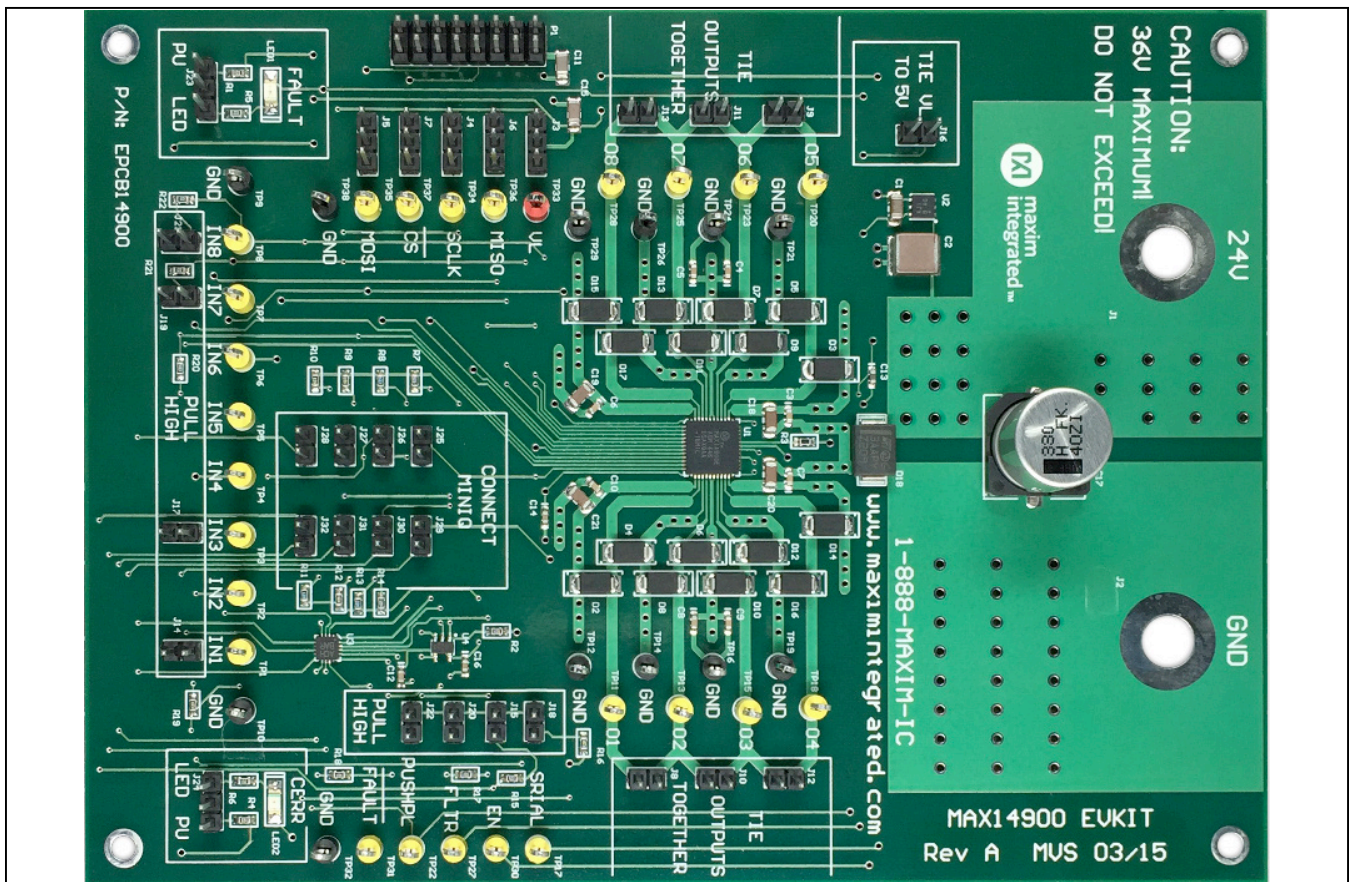

## Quick Start

### Recommended Equipment

- MAX14900E EV kit
- 24V, 2A power supply
- Function generator
- Oscilloscope
- 50Ω, 15W (minimum) load resistor
- 5kΩ resistor
- Voltmeter
- Bench tie clips with spring clips on both ends

### Procedure

The EV kit is fully assembled and tested. Follow the steps below to verify board operation:

- 1) Preset the 24V power supply to 24V and disable the power supply.
- 2) Connect the ground of the 24V power supply to jumper J2.
- 3) Connect the positive supply of the 24V power supply to J1.
- 4) Ensure that the shunt for J15 (EN) is installed.
- 5) Ensure that the shunt for J16 (connect  $V_L$  to 5V) is installed.
- 6) Ensure that J22 (PUSHPL) is installed.
- 7) Ensure that all other shunts are not installed.
- 8) Preset the function generator to pulse, 20ms pulse width, 500ms repetition rate, low-voltage 0V, high-voltage 5V, and disable the pulse generator.
- 9) Connect a 5kΩ resistor between O1 (TP11) and GND (TP12).
- 10) Connect an oscilloscope between O1 (TP11) and GND (TP12).
- 11) Connect the function generator between IIN1 (TP1) and GND (TP10).
- 12) Enable the 24V power supply.
- 13) Enable the function generator.
- 14) Observe the output waveform on the oscilloscope.
- 15) Disable the function generator.
- 16) Change the resistor from 5kΩ to 50Ω.
- 17) Remove the shunt on J22 (PUSHPL).
- 18) Enable the function generator.
- 19) Observe the output waveform on the oscilloscope.

### Detailed Description

The MAX14900E octal, high-speed, industrial, high-side switch EV kit is a fully assembled and tested, surface-mount PCB that demonstrates the capabilities of the MAX14900E IC to drive industrial-grade signals.

This EV kit demonstrates operation in all MAX14900E modes. In parallel mode, jumpers allow for arbitrary configuration. In serial mode, or in parallel mode with serial monitoring, attach a control circuit to the appropriate test points. The EV kit operates from a single 24V (11V to 36V) main supply, and an optional logic supply. Through parallel or serial control, the IC switches the 24V supply to any combination of eight independent outputs. Besides the device itself, there are plenty of attach points, as well as numerous jumpers. The EV kit has little added circuitry.

TVS diode D18 protects the device from surges that may appear on the supply line through the clamp diodes. Note that D18 will likely be destroyed if the user applies a voltage greater than 36V on the 24V supply. Sixteen silicon diodes (D2–D17) protect the individual MAX14900E power outputs from severe inductive kickback events, as well as surges. A linear regulator, MAX5084 (U2), provides an optional default 5V in case the user does not wish to provide a logic-level supply externally. LED1 (FAULT) can be optionally configured to light whenever the device indicates a fault condition on its  $\overline{\text{FAULT}}$  pin. LED2 (CERR) can be optionally configured to light when the device detects a CRC error in serial mode.

### Input Power Supply

The EV kit obtains its primary power from a bench supply whose positive voltage attaches to J1 (24V), and whose return voltage attaches to J2 (GND). This supplies power only to the MAX14900E.

### 5V Power Supply

The device requires a 5V supply on pin 30 (V5), supplied by the 5V linear regulator (U2) for the user's convenience.

### Logic Power Supply

Most of the device's digital pins have their input thresholds and their output drive levels defined by the voltage on pin 13 ( $V_L$ ). This  $V_L$  supply can come from two places. First, the built-in 5V regulator can supply  $V_L$  by attaching a shunt to J16 (connect  $V_L$  to 5V), ensuring that no shunt is attached to J3 ( $V_L$ ). When attaching external circuitry

to control and monitor the device, attach a voltage representing the external logic to TP33 ( $V_L$ ), and attach a shunt to J3 ( $V_L$ ) between the center and right posts.

### Paralleling Outputs

The EV kit makes it easy to parallel up to four outputs together to deal with higher loads. J8, J10, and J12, when shunted, connect outputs O1–O4 together in various configurations. Similarly, J9, J11, and J13, when shunted, connect outputs O5–O8 in various configurations. To determine which outputs short to what, see [Table 1](#) for jumper and output information. The copper traces on the board are also evident from output to each jumper.

### Dedicated Configuration Pins

J15 (EN), J20 (FLTR), and J22 (PUSHPL) set their respective pins high. When not shunted, these pins are driven logic-low from individual pulldowns inside the device.

### Parallel Mode

To put the EV kit in parallel mode, ensure that no shunt is attached to J18 (SRIAL). Fault conditions can be monitored in two ways. First, attach a shunt between the right and center pins of J23. LED1 glows red whenever the device reports a fault condition. Otherwise, a fault condition can be monitored by attaching external monitoring circuitry to TP31 (FAULT). The MAX14900E  $\overline{\text{FAULT}}$  pin is open-drain.

If the external circuitry attached to TP31 ( $\overline{\text{FAULT}}$ ) has a pullup, ensure that J23 has no shunts attached. If the external circuitry has no pullup, attach a shunt to J23 between the left and center posts. External circuitry drives the parallel inputs at TP1–TP8. See [Table 3](#), describing how these control signals on TP1–TP8 determine the state of the outputs O1 through O8. In addition, three signals control how the TP1–TP8 control inputs are interpreted, as detailed in [Table 4](#).

### Serial Mode Through External Circuitry

To drive the serial SPI interface of the device through external circuitry, ensure that J4–J7 each have shunts attached between the center and right posts. Then, attach the corresponding external SPI controls with TP34–TP37. The state of the SRIAL pin must be set appropriately. If running in monitored-parallel mode, SRIAL must be low (J18 has no shunt). If running in serial mode, J18 must be shunted.

### Dual-Function Configuration Pins

When running in serial mode (not monitored-parallel mode or parallel mode), IN1, IN3, IN7, and IN8 become extra configuration pins. These pins are driven logic-low through weak internal pulldowns inside the device, but can be set high attaching shunts to J14, J17, J19, or J21.

Refer to the MAX14900E IC data sheet for a detailed description of these pin functions. Additionally, in serial mode, IN4 becomes an open-drain output, indicating a CRC error in a received serial-command stream. To see the state of this pin in serial mode, attach a shunt between the left and center posts of J24. LED2 glows red in case of a CRC error.

Table 1. Jumper Description (J3–J32)

JUMPER	SHUNT POSITION	DESCRIPTION
J3	LEFT	Do not use
	RIGHT	$V_L$ powered by TP33 ( $V_L$ )
	OPEN*	$V_L$ powered by the 5V regulator (see J16)
J4	LEFT	Do not use
	RIGHT	SCLK driven by signal on TP34 (SCLK)
	OPEN*	SCLK not driven
J5	LEFT	Do not use
	RIGHT	SDI driven by signal on TP35 (MOSI)
	OPEN*	SDI not driven
J6	LEFT	Do not use
	RIGHT	SDO drives signal on TP36 (MISO)
	OPEN*	SDO not driven
J7	LEFT	Do not use
	RIGHT	$\overline{CS}$ driven by signal on TP37 ( $\overline{CS}$ )
	OPEN*	$\overline{CS}$ not driven
J8	SHUNTED	Outputs TP11 (O1) and TP13 (O2) connected
	OPEN*	Outputs TP11 (O1) and TP13 (O2) separate
J9	SHUNTED	Outputs TP20 (O5) and TP23 (O6) connected
	OPEN*	Outputs TP20 (O5) and TP23 (O6) separate
J10	SHUNTED	Outputs TP13 (O2) and TP15 (O3) connected
	OPEN*	Outputs TP13 (O2) and TP15 (O3) separate
J11	SHUNTED	Outputs TP23 (O6) and TP25 (O7) connected
	OPEN*	Outputs TP23 (O6) and TP25 (O7) separate
J12	SHUNTED	Outputs TP15 (O3) and TP18 (O4) connected
	OPEN*	Outputs TP15 (O3) and TP18 (O4) separate
J13	SHUNTED	Outputs TP25 (O7) and TP28 (O8) connected
	OPEN*	Outputs TP25 (O7) and TP28 (O8) separate
J14	SHUNTED	TP1 (IN1) pulled to $V_L$
	OPEN*	TP1 (IN1) internally pulled weakly to ground
J15	SHUNTED*	EN pulled to $V_L$
	OPEN	EN internally pulled weakly to ground
J16	SHUNTED*	Power $V_L$ from the built-in 5V regulator
	OPEN	Power $V_L$ according to J3
J17	SHUNTED	TP3 (IN3) pulled to $V_L$
	OPEN*	TP3 (IN3) internally pulled weakly to ground
J18	SHUNTED	SRIAL pulled to $V_L$
	OPEN*	SRIAL internally pulled weakly to ground
J19	SHUNTED	TP7 (IN7) pulled to $V_L$
	OPEN*	TP7 (IN7) internally pulled weakly to ground

**Table 1. Jumper Description (J3–J32) (continued)**

JUMPER	SHUNT POSITION	DESCRIPTION
J20	SHUNTED	FLTR pulled to $V_L$
	OPEN*	FLTR internally pulled weakly to ground
J21	SHUNTED	TP8 (IN8) pulled to $V_L$
	OPEN*	TP8 (IN8) internally pulled to ground
J22	SHUNTED*	PUSHPL pulled to $V_L$
	OPEN	PUSHPL internally pulled to ground
J23	LEFT	$\overline{\text{FAULT}}$ output pulled to $V_L$ with 10K $\Omega$
	RIGHT*	$\overline{\text{FAULT}}$ output state indicated by LED1 (FAULT)
	OPEN	$\overline{\text{FAULT}}$ output not pulled up
J24	LEFT	IN4 pulled to $V_L$ with 10K $\Omega$
	RIGHT	IN4 state indicated by LED2 (CERR)
	OPEN*	IN4 not pulled up
J25-J32	SHUNTED	Do not use
	OPEN*	Do not use

\*Default position.

**Table 2. Test Point Description**

TEST POINT	DESCRIPTION
TP1 (IN1)	Drive IN1 when in parallel mode
TP2 (IN2)	Drive IN2 when in parallel mode
TP3 (IN3)	Drive IN3 when in parallel mode
TP4 (IN4)	Drive IN4 when in parallel mode
TP5 (IN5)	Drive IN5 when in parallel mode
TP6 (IN6)	Drive IN6 when in parallel mode
TP7 (IN7)	Drive IN7 when in parallel mode
TP8 (IN8)	Drive IN8 when in parallel mode
TP9 (GND)	Ground attach point
TP10 (GND)	Ground attach point
TP11 (O1)	Connect a load to O1 here
TP12 (GND)	Connect the O1 return here
TP13 (O2)	Connect a load to O2 here
TP14 (GND)	Connect the O2 return here
TP15 (O3)	Connect a load to O3 here
TP16 (GND)	Connect the O3 return here
TP17 (SRIAL)	Drive SRIAL here
TP18 (O4)	Connect a load to O4 here
TP19 (GND)	Connect the O4 return here
TP20 (O5)	Connect a load to O5 here

TEST POINT	DESCRIPTION
TP21 (GND)	Connect the O5 return here
TP22 (PUSHPL)	Drive PUSHPL here (see also J22)
TP23 (O6)	Connect a load to O6 here
TP24 (GND)	Connect the O6 return here
TP25 (O7)	Connect a load to O7 here
TP26 (GND)	Connect the O7 return here
TP27 (FLTR)	Drive FLTR here (see also J20)
TP28 (O8)	Connect a load to O8 here
TP29 (GND)	Connect the O8 return here
TP30 (EN)	Drive EN here (see also J15)
TP31 ( $\overline{\text{FAULT}}$ )	Indicate the state of $\overline{\text{FAULT}}$ here
TP32 (GND)	Digital interface ground attach point
TP33 ( $V_L$ )	Connect an external $V_L$ supply here (see also J3 and J6)
TP34 (SCLK)	Drive optional SPI clock here
TP35 (MOSI)	Drive optional SPI MOSI here
TP36 (MISO)	Receive optional SPI MISO here
TP37 ( $\overline{\text{CS}}$ )	Drive optional SPI $\overline{\text{CS}}$ here
TP38 (GND)	SPI interface ground attach point

**Table 3. Parallel Driving Truth Table**

TP_ (IN_)	O_ STATE	
	PUSH-PULL	HIGH-SIDE
0	Low	Off
1	High	On

**Table 4. Global Configuration Inputs**

INPUT	CONFIGURATION FUNCTION
FLTR	Enables anti-glitch filtering on all logic inputs TP1–TP8 0 = Glitch filtering disabled 1 = Glitch filtering enabled
PUSHPL	Configures all O1–O8 outputs as either push-pull or high-side 0 = All drivers high-side mode 1 = All drivers push-pull mode
EN	Enables normal operation of all O1–O8 outputs 0 = All outputs high impedance 1 = Normal operation

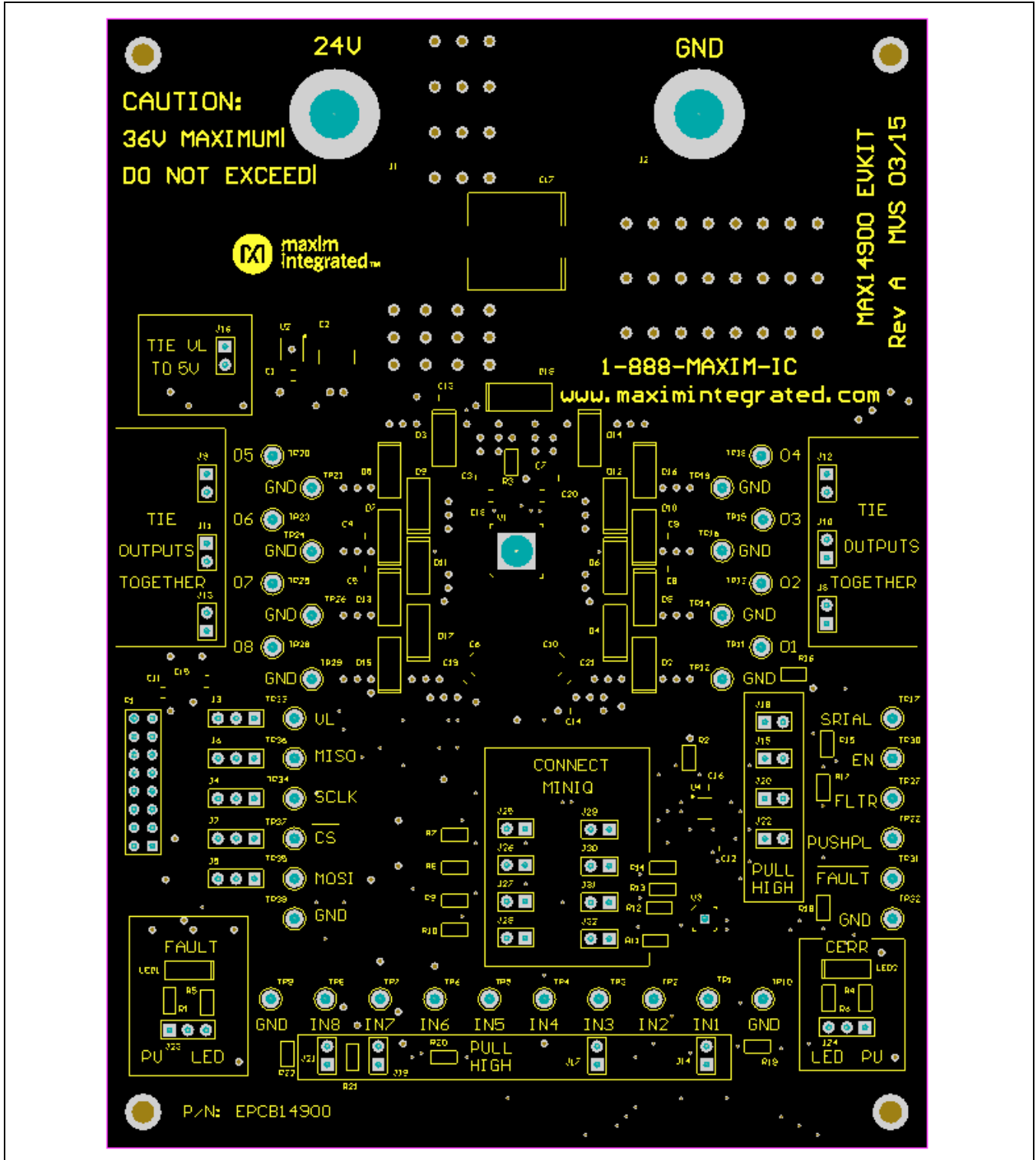

Figure 1. MAX14900E EV Kit Component Placement Guide—Top Silkscreen

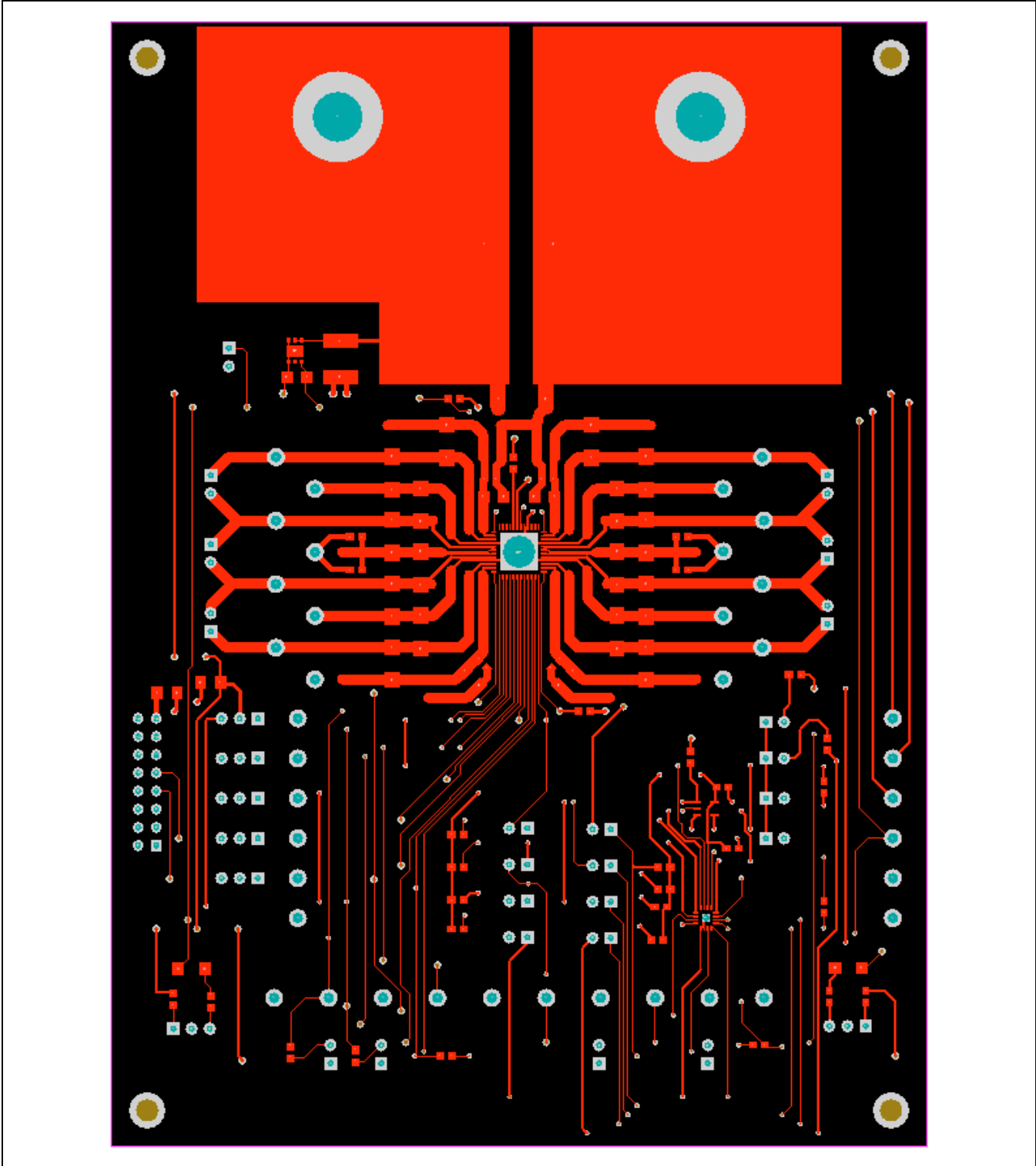

Figure 2. MAX14900E EV Kit PCB Layout—Top Layer



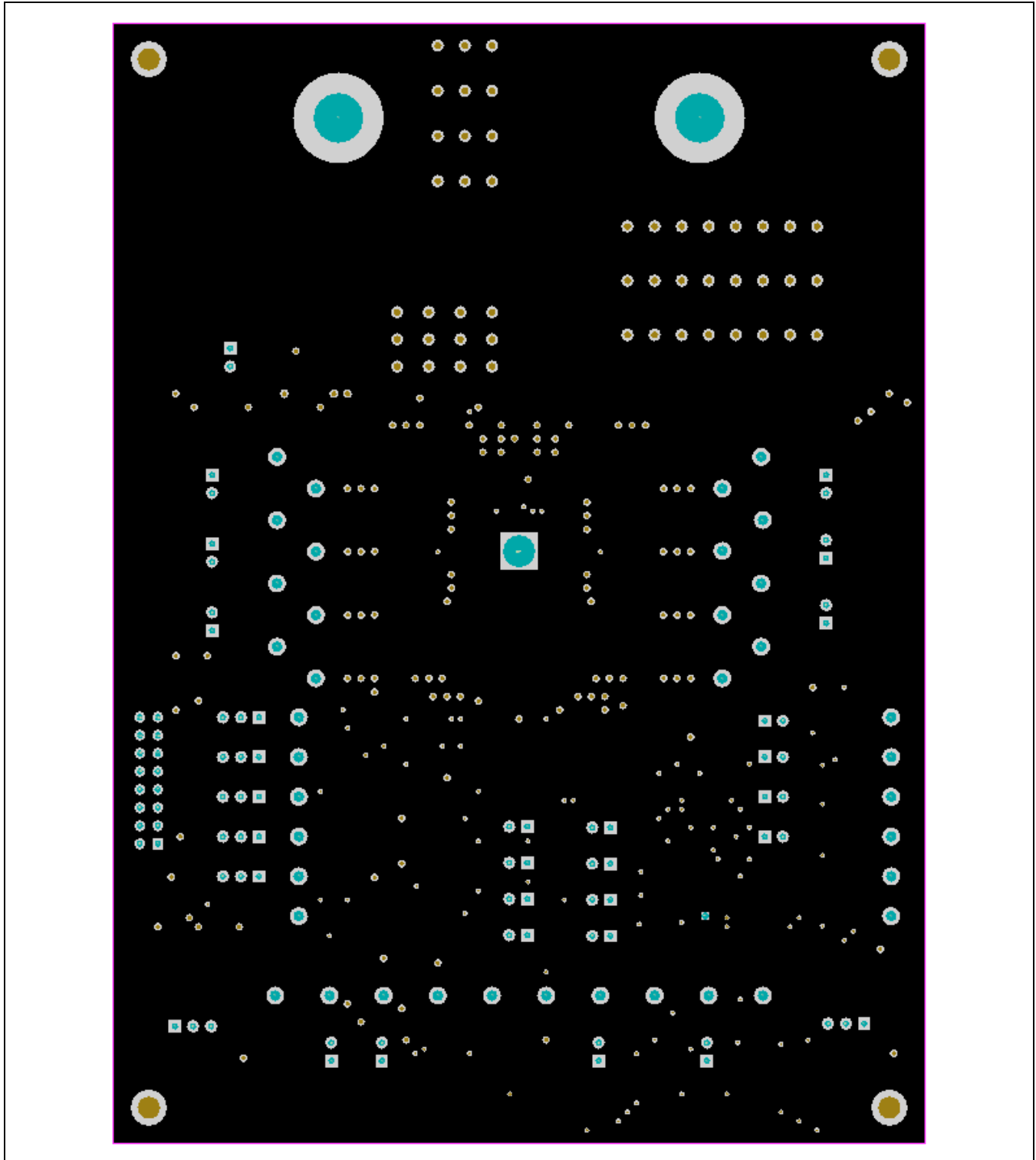

Figure 3. MAX14900E EV Kit PCB Layout, Internal Plane 1—GND

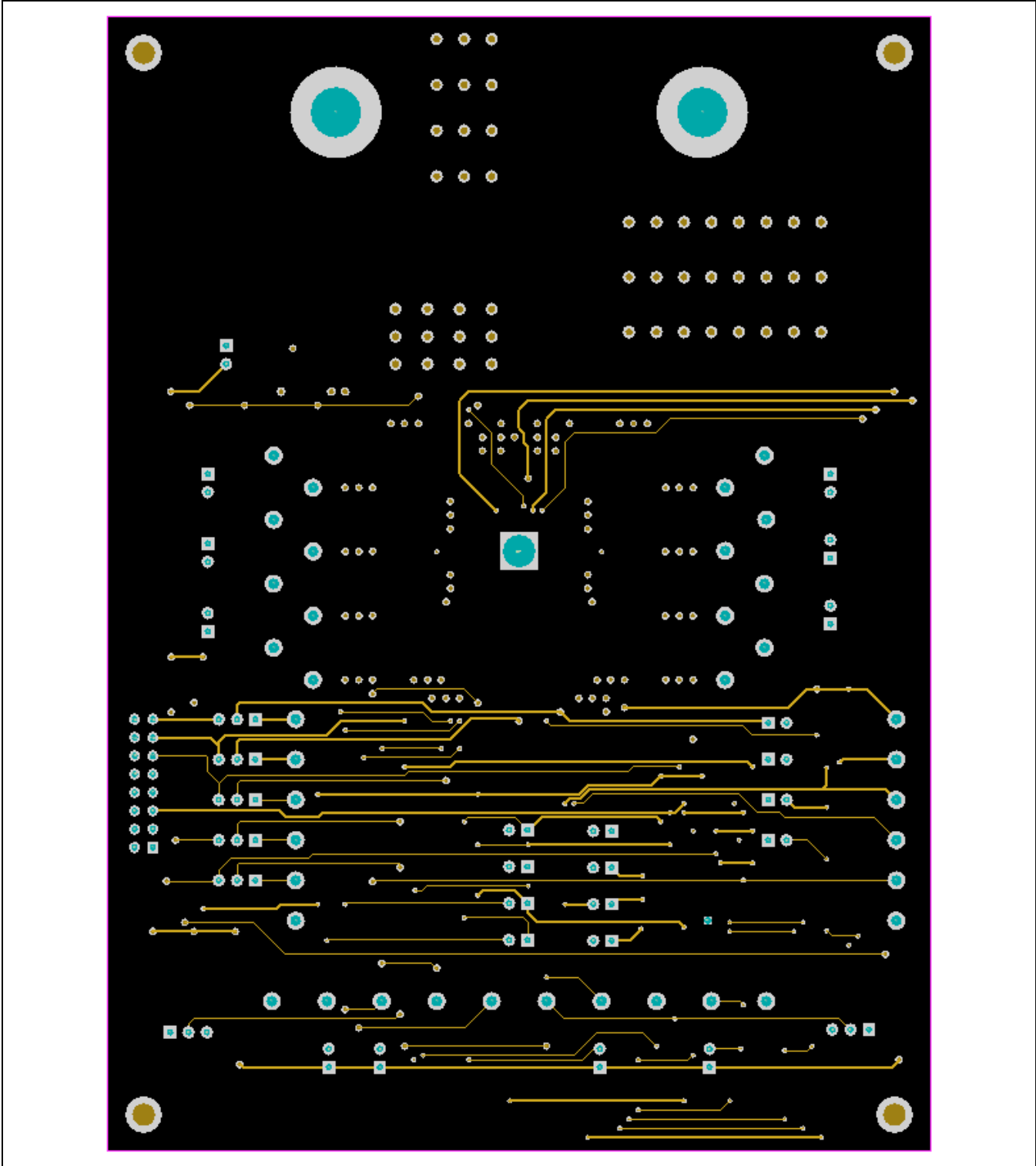

Figure 4. MAX14900E EV Kit PCB Layout—Mid-Layer 1

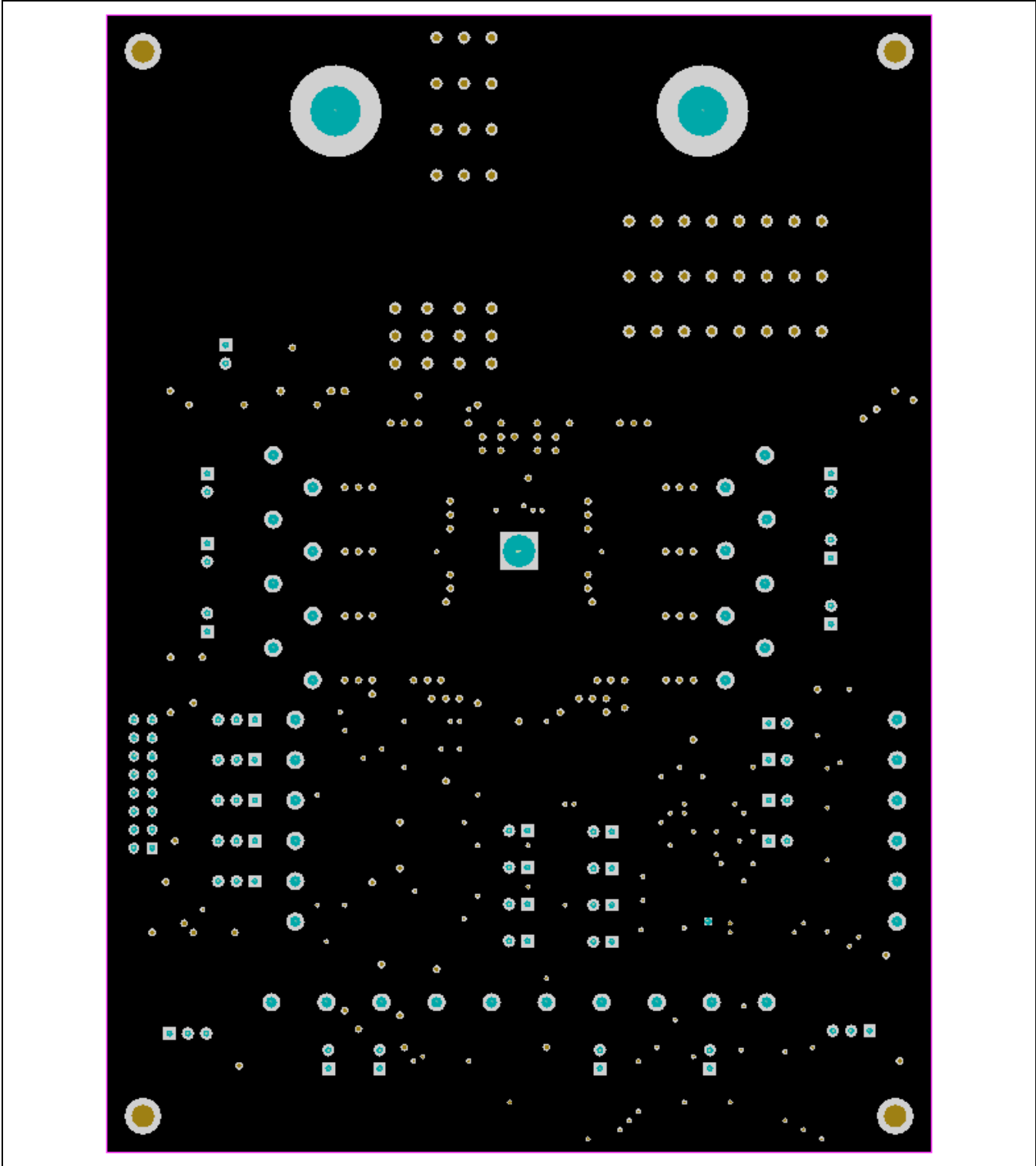

Figure 5. MAX14900E EV Kit PCB Layout, Internal Plane 2—GND

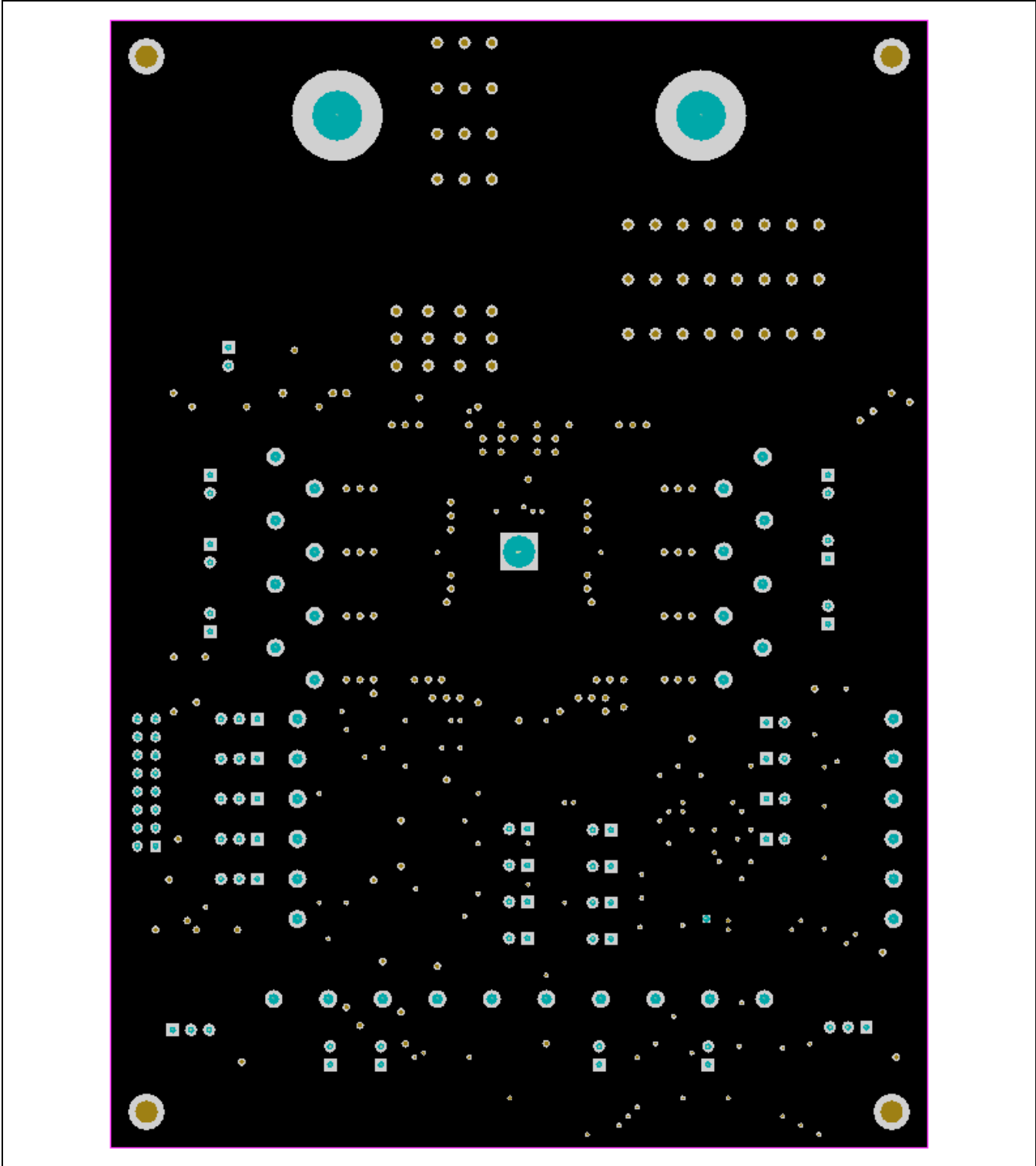

Figure 6. MAX14900E EV Kit PCB Layout, Internal Plane 3—V24V

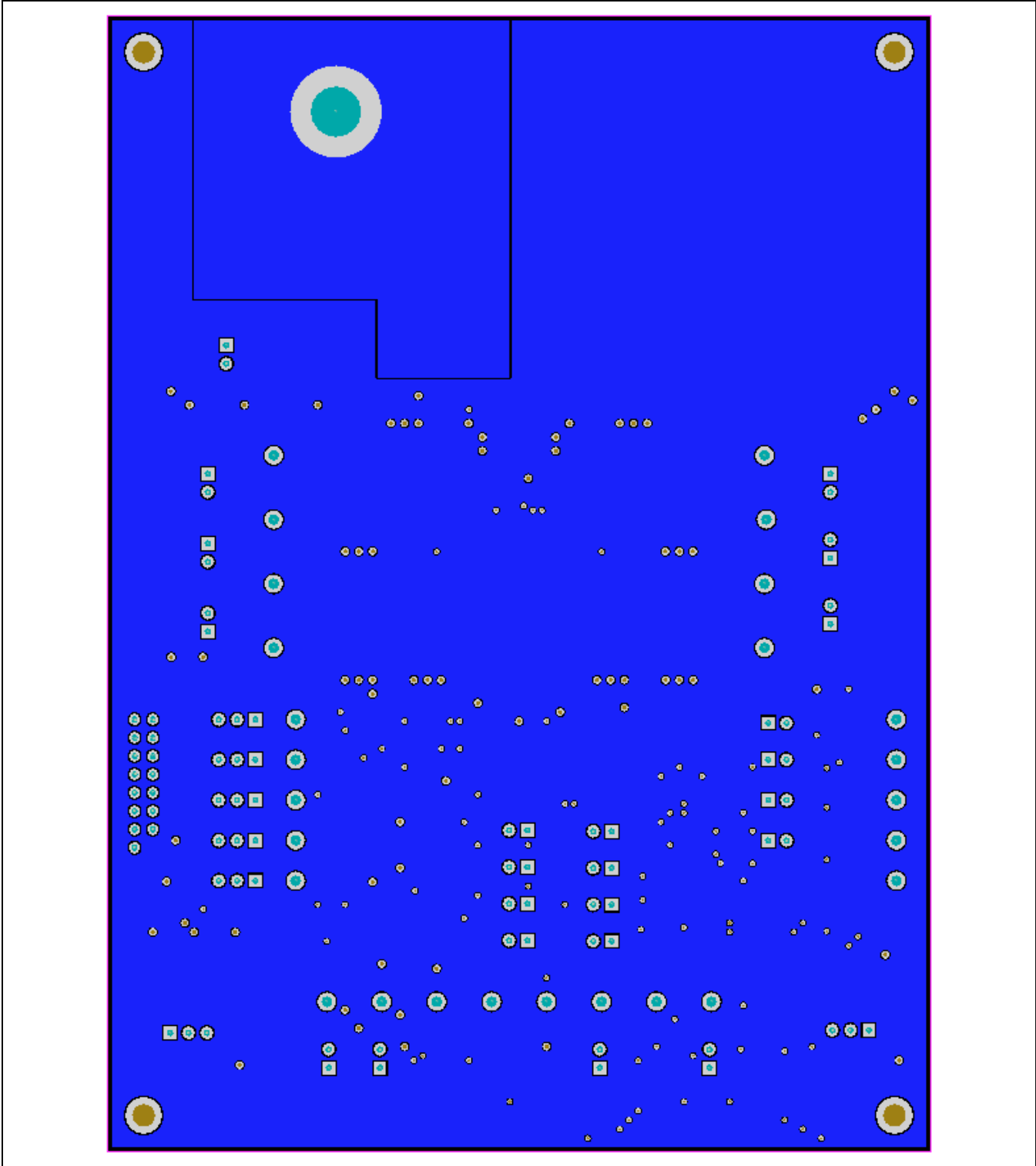

Figure 7. MAX14900E EV Kit Component Placement Guide—Bottom Layer

### Component List and Schematic

See the following links for component information and schematics:

- [MAX14900E EV BOM](#)
- [MAX14900E EV Schematic](#)

### Ordering Information

PART	TYPE
MAX14900DEVBRD#	EV Kit

*#Denotes RoHS compliant.*

### Revision History

REVISION NUMBER	REVISION DATE	DESCRIPTION	PAGES CHANGED
0	5/15	Initial release	—

For pricing, delivery, and ordering information, please contact Maxim Direct at 1-888-629-4642, or visit Maxim Integrated's website at [www.maximintegrated.com](http://www.maximintegrated.com).

*Maxim Integrated cannot assume responsibility for use of any circuitry other than circuitry entirely embodied in a Maxim Integrated product. No circuit patent licenses are implied. Maxim Integrated reserves the right to change the circuitry and specifications without notice at any time.*

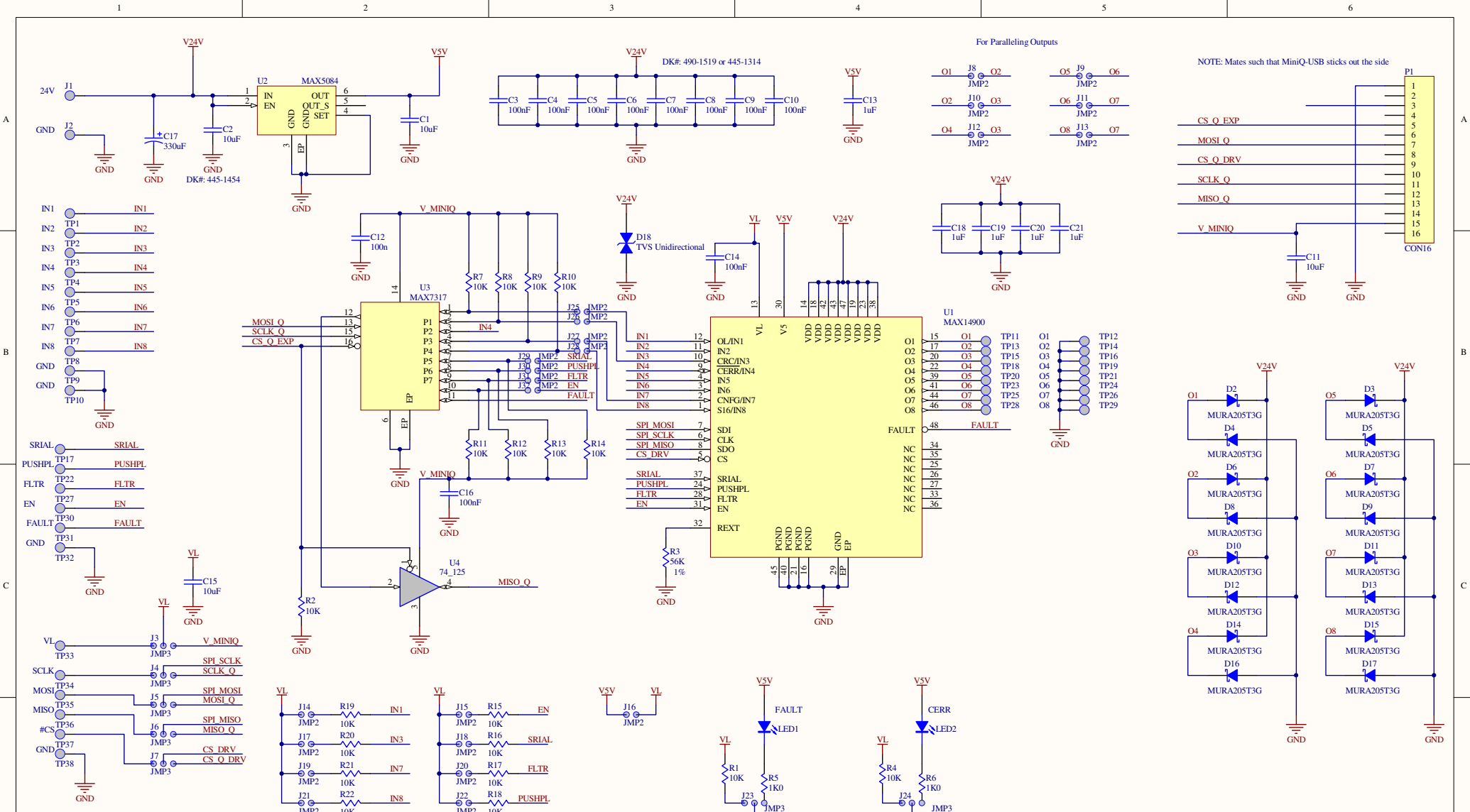

NOTE: Mates such that MiniQ-USB sticks out the side

Title			REVISION A		
Size	Number			Revision	
B					
Date:	11/16/2015			Sheet of	
File:					



# BILL OF MATERIALS (BOM)

DESIGNATOR	QTY	DESCRIPTION	MFG	MFG P/N
C1, C11, C15	3	10uF 10V 10% X5R 1206	Kemet	C1206C106K8RACTU
C2	1	10uF 50V 20% X7R 2220	TDK	C5750X7R1H106M
C3-C10	8	0.1uF 50V 10% X7R 0603	Murata	GRM188R71H104KA93D
C12, C14, C16	3	0.1uF 16V 10% X7R 0603	AVX	0603YC104KAZ2A
C13	1	1uF 16V 10% X7R 0603	AVX	0603YC105KAT2A
C17	1	Alum 330uF 20% SMD	Pana	EEEFK1H331AQ
C18-C21	4	1uF 50V 10% X7R 1206	TDK	C3216X7R1H105K
D2-D17	16	Diode Gen Purp 50V 2A SMA	On Semi	MURA205T3G
D18	1	TVS Diode 33VWM 58VC SMC	STMicro	SM30T39AY
J1-J2	2	STD Uninsulated Banana Jack	Pomona	Model 3267
J3-J7, J23-J24	7	Conn Header 50POS .100" Sngl Tin (3)	Various	
J8-J22, J25-J32	23	Conn Header 50POS .100" Sngl Tin	Various	
LED1-LED2	2	LED Red Clear 1206	Lite-On	LTST-C150CKT
P1	1	Conn Header .100 Dual 72POS	Various	
R1-R2, R4, R7-R22	19	RES 10K Ohm 1/10W 5% 0603	Pana	ERJ-3GEYJ103V
R3	1	RES 56.0K Ohm 1/10W 1% 0603	Pana	ERJ-3EKF5602V
R5-R6	2	RES 1.0K Ohm 1/10W 5% 0603	Pana	ERJ-3GEYJ102V
TP1-TP8, TP11, TP13, TP15, TP17-TP18, TP20, TP22-TP23, TP25, TP27-TP28, TP30-TP31, TP34-TP37	25	Test Point PC Multi Purpose Yel	Keystone	5014
TP9-TP10, TP12, TP14, TP16, TP19, TP21, TP24, TP26, TP29, TP32, TP38	12	Test Point PC Multi Purpose Blk	Keystone	5011
TP33	1	Test Point PC Multi Purpose Red	Keystone	5010
U1	1	MAX14900EAGM+	Maxim	MAX14900EAGM+CKT
U2	1	MAX5084ATT+	Maxim	MAX5084ATT+
U3	1	MAX7317ATE+	Maxim	MAX7317ATE+
U4	1	Bus Buff Tri-St N-Inv SOT23-5	TI	SN74AHC1G125DBVR