

**Low  $V_{CE(sat)}$  IGBT**  
**High Speed IGBT**

**IXSH/IXSM 40 N60**  
**IXSH/IXSM 40 N60A**

$V_{CES}$	$I_{C25}$	$V_{CE(sat)}$
600 V	75 A	2.5 V
600 V	75 A	3.0 V

**Short Circuit SOA Capability**

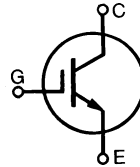

Symbol	Test Conditions	Maximum Ratings	
$V_{CES}$	$T_J = 25^\circ\text{C}$ to $150^\circ\text{C}$	600	V
$V_{CGR}$	$T_J = 25^\circ\text{C}$ to $150^\circ\text{C}$ ; $R_{GE} = 1\ \text{M}\Omega$	600	V
$V_{GES}$	Continuous	$\pm 20$	V
$V_{GEM}$	Transient	$\pm 30$	V
$I_{C25}$	$T_C = 25^\circ\text{C}$	75	A
$I_{C90}$	$T_C = 90^\circ\text{C}$	40	A
$I_{CM}$	$T_C = 25^\circ\text{C}$ , 1 ms	150	A
<b>SSOA (RBSOA)</b>	$V_{GE} = 15\ \text{V}$ , $T_J = 125^\circ\text{C}$ , $R_G = 2.7\ \Omega$ Clamped inductive load, $L = 30\ \mu\text{H}$	$I_{CM} = 80$ @ $0.8\ V_{CES}$	A
<b><math>t_{SC}</math> (SCSOA)</b>	$V_{GE} = 15\ \text{V}$ , $V_{CE} = 360\ \text{V}$ , $T_J = 125^\circ\text{C}$ $R_G = 22\ \Omega$ , non repetitive	10	$\mu\text{s}$
$P_c$	$T_C = 25^\circ\text{C}$	300	W
$T_J$		-55 ... +150	$^\circ\text{C}$
$T_{JM}$		150	$^\circ\text{C}$
$T_{stg}$		-55 ... +150	$^\circ\text{C}$
$M_d$	Mounting torque	1.13/10 Nm/lb.in.	
<b>Weight</b>		TO-204 = 18 g, TO-247 = 6g	
Maximum lead temperature for soldering 1.6 mm (0.062 in.) from case for 10 s		300	$^\circ\text{C}$

**TO-247 AD (IXSH)**

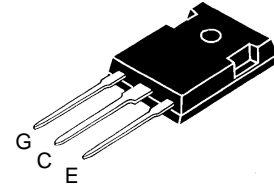

**TO-204 AE (IXSM)**

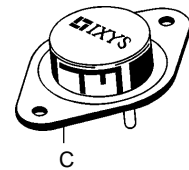

G = Gate,  
E = Emitter,

C = Collector,  
TAB = Collector

**Features**

- International standard packages
- Guaranteed Short Circuit SOA capability
- Low  $V_{CE(sat)}$ 
  - for low on-state conduction losses
- High current handling capability
- MOS Gate turn-on
  - drive simplicity
- Fast Fall Time for switching speeds up to 20 kHz

**Applications**

- AC motor speed control
- Uninterruptible power supplies (UPS)
- Welding

**Advantages**

- Easy to mount with 1 screw (TO-247) (isolated mounting screw hole)
- High power density

Symbol	Test Conditions	Characteristic Values ( $T_J = 25^\circ\text{C}$ , unless otherwise specified)		
		min.	typ.	max.
$BV_{CES}$	$I_C = 250\ \mu\text{A}$ , $V_{GE} = 0\ \text{V}$	600		V
$V_{GE(th)}$	$I_C = 4\ \text{mA}$ , $V_{CE} = V_{GE}$	4		7 V
$I_{CES}$	$V_{CE} = 0.8 \cdot V_{CES}$ , $T_J = 25^\circ\text{C}$ $V_{GE} = 0\ \text{V}$ , $T_J = 125^\circ\text{C}$			50 $\mu\text{A}$ 1 mA
$I_{GES}$	$V_{CE} = 0\ \text{V}$ , $V_{GE} = \pm 20\ \text{V}$			$\pm 100\ \text{nA}$
$V_{CE(sat)}$	$I_C = I_{C90}$ , $V_{GE} = 15\ \text{V}$	40N60 40N60A		2.5 V 3.0 V

Symbol	Test Conditions	Characteristic Values ( $T_J = 25^\circ\text{C}$ , unless otherwise specified)		
		min.	typ.	max.
$g_{fs}$	$I_C = I_{C90}$ ; $V_{CE} = 10\text{ V}$ , Pulse test, $t \leq 300\ \mu\text{s}$ , duty cycle $\leq 2\%$	16	23	S
$I_{C(on)}$	$V_{GE} = 15\text{ V}$ , $V_{CE} = 10\text{ V}$		200	A
$C_{ies}$	$V_{CE} = 25\text{ V}$ , $V_{GE} = 0\text{ V}$ , $f = 1\text{ MHz}$		4500	pF
$C_{oes}$			350	pF
$C_{res}$			90	pF
$Q_g$	$I_C = I_{C90}$ , $V_{GE} = 15\text{ V}$ , $V_{CE} = 0.5 V_{CES}$		190	nC
$Q_{ge}$			45	nC
$Q_{gc}$			88	nC
$t_{d(on)}$	<b>Inductive load, <math>T_J = 25^\circ\text{C}</math></b> $I_C = I_{C90}$ , $V_{GE} = 15\text{ V}$ , $L = 100\ \mu\text{H}$ $V_{CE} = 0.8 V_{CES}$ , $R_G = 2.7\ \Omega$ Switching times may increase for $V_{CE}$ (Clamp) $> 0.8 \cdot V_{CES}$ , higher $T_J$ or increased $R_G$		55	ns
$t_{ri}$			170	ns
$t_{d(off)}$			400	ns
$t_{fi}$		40N60	400	ns
		40N60A	200	ns
$E_{off}$	40N60	5.0	mJ	
	40N60A	2.5	mJ	
$t_{d(on)}$	<b>Inductive load, <math>T_J = 125^\circ\text{C}</math></b> $I_C = I_{C90}$ , $V_{GE} = 15\text{ V}$ , $L = 100\ \mu\text{H}$ $V_{CE} = 0.8 V_{CES}$ , $R_G = 2.7\ \Omega$ Remarks: Switching times may increase for $V_{CE}$ (Clamp) $> 0.8 \cdot V_{CES}$ , higher $T_J$ or increased $R_G$		55	ns
$t_{ri}$			170	ns
$E_{on}$			1.7	mJ
$t_{d(off)}$		40N60	1000	ns
		40N60A	340	525
$t_{fi}$	40N60	600	1500	
	40N60A	340	700	
$E_{off}$	40N60	12	mJ	
	40N60A	6	mJ	
$R_{thJC}$			0.42	K/W
$R_{thCK}$			0.25	K/W

### TO-247 AD Outline

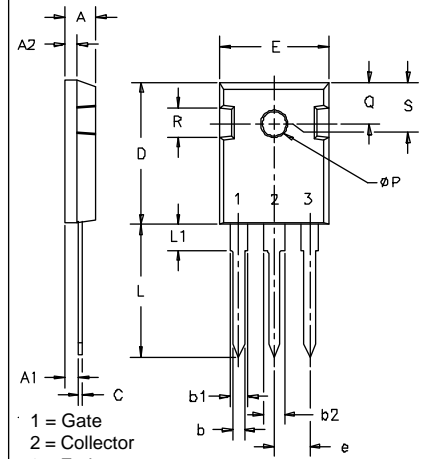

SYM	INCHES		MILLIMETERS	
	MIN	MAX	MIN	MAX
A	.185	.209	4.7	5.3
A1	.087	.102	2.2	2.54
A2	.059	.098	2.2	2.6
b	.040	.055	1.0	1.4
b1	.065	.084	1.65	2.13
b2	.113	.123	2.87	3.12
C	.016	.031	.4	.8
D	.819	.845	20.80	21.46
E	.610	.640	15.75	16.26
e	.215 BSC		5.45	BSC
L	.780	.800	19.81	20.32
L1		.177		4.50
$\phi P$	.140	.144	3.55	3.65
Q	.212	.244	5.4	6.2
R	.170	.216	4.32	5.49
S	.242 BSC		6.15	BSC

### TO-204AE Outline

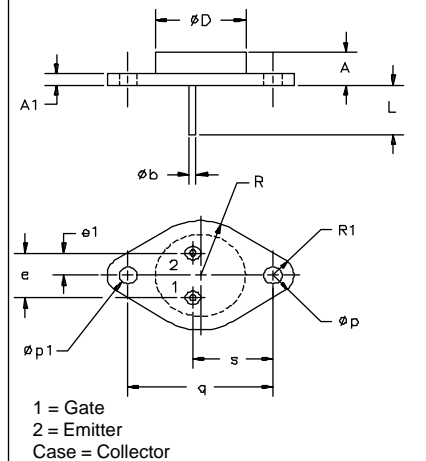

SYM	INCHES		MILLIMETERS	
	MIN	MAX	MIN	MAX
A	.250	.450	6.4	11.4
A1	.060	.135	1.53	3.42
$\phi b$	.057	.063	1.45	1.60
$\phi D$		.875		22.22
e	.420	.440	10.67	11.17
e1	.205	.225	5.21	5.71
L	.440	.480	11.18	12.19
$\phi p$	.151	.165	3.84	4.19
$\phi p1$	.151	.165	3.84	4.19
q	1.187 BSC		30.15	BSC
R	.495	.525	12.58	13.33
R1	.131	.188	3.33	4.77
s	.655	.675	16.64	17.14

IXYS reserves the right to change limits, test conditions, and dimensions.

IXYS Corporation  
3540 Bassett Street, Santa Clara CA 95054  
P

IXYS Semiconductor GmbH  
Edisonstr. 15, D-68623 Lampertheim  
Phone: +49-6206-503-0, Fax: +49-6206-503627

IXYS MOSFETs and IGBTs are covered by one of the following U.S. patents: 4,835,592 4,881,108 5,017,508 5,049,961 5,187,117 5,486,715  
4,850,072 4,931,844 5,034,796 5,063,307 5,237,481 5,381,025

**Fig. 1 Saturation Characteristics**

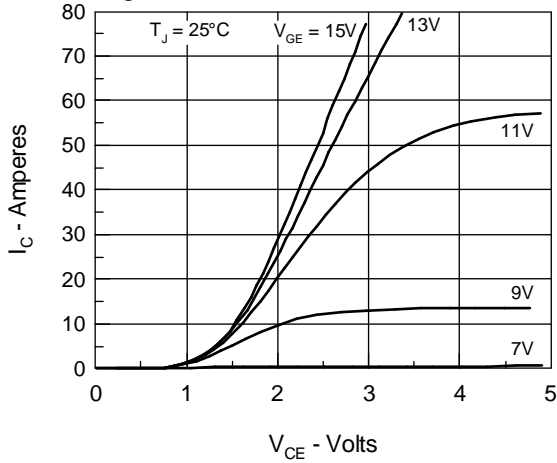

**Fig. 2 Output Characteristics**

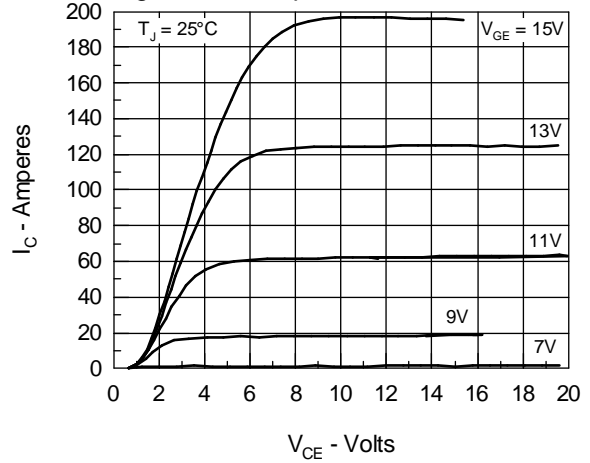

**Fig. 3 Collector-Emitter Voltage vs. Gate-Emitter Voltage**

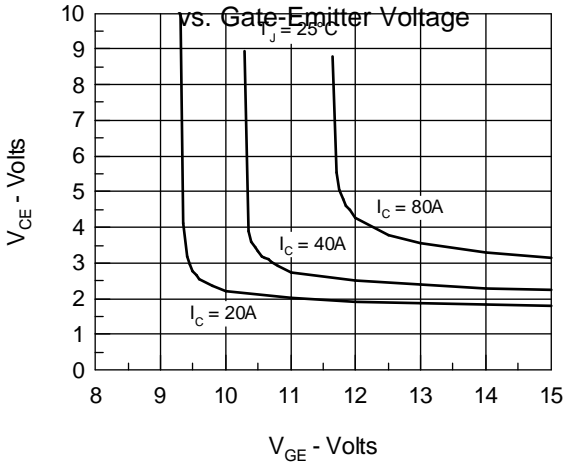

**Fig. 4 Temperature Dependence of Output Saturation Voltage**

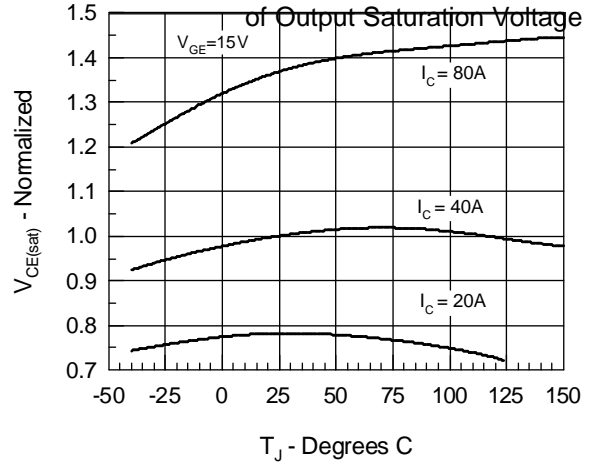

**Fig. 5 Input Admittance**

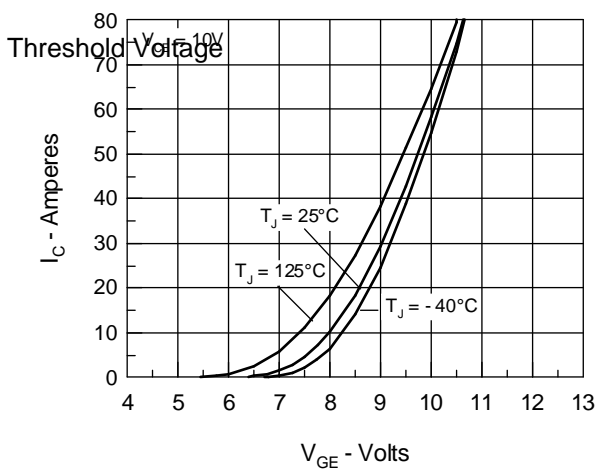

**Fig. 6 Temperature Dependence of Breakdown and**

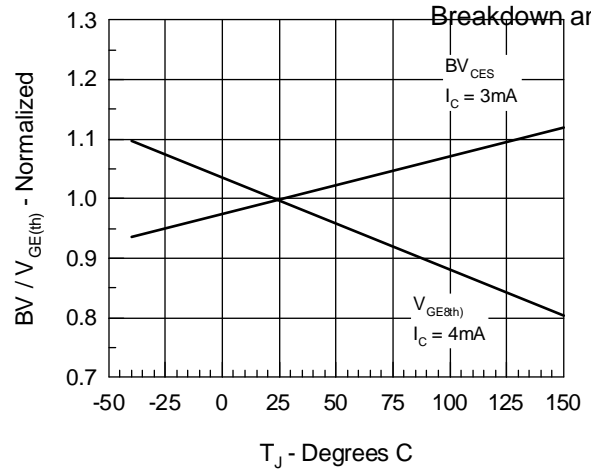

**Fig.7 Turn-Off Energy per Pulse and Fall Time on Collector Current**

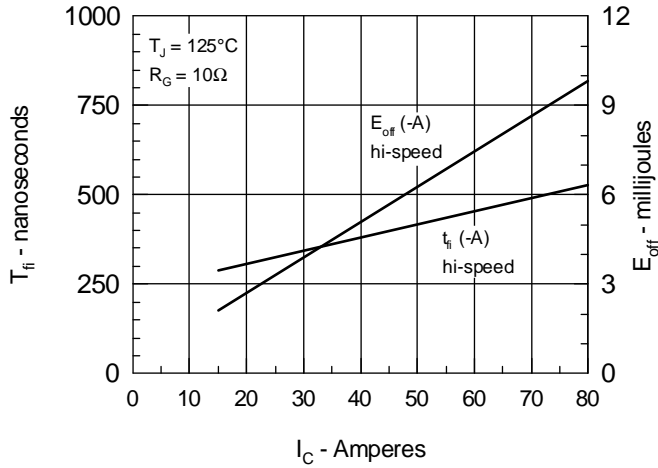

**Fig.8 Dependence of Turn-Off Energy Per Pulse and Fall Time on R\_G**

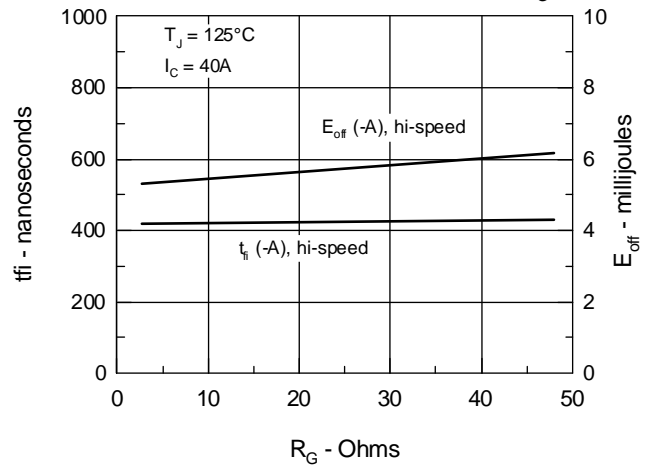

**Fig.9 Gate Charge Characteristic Curve**

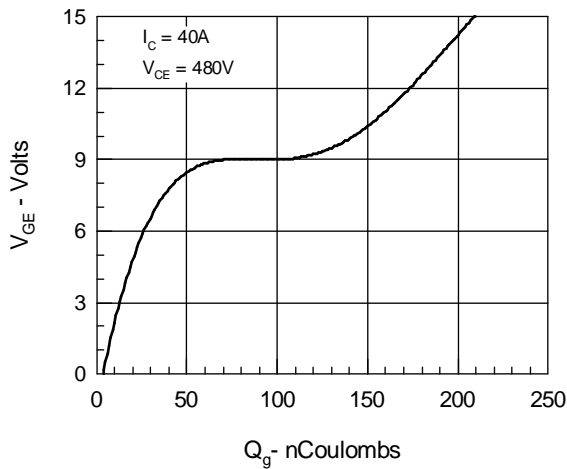

**Fig.10 Turn-Off Safe Operating Area**

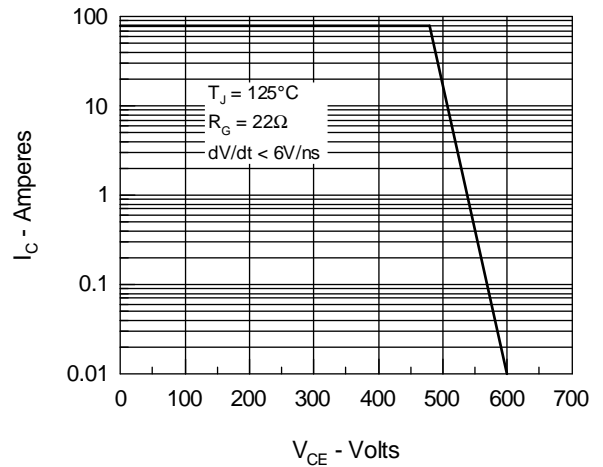

**Fig.11 Transient Thermal Impedance**

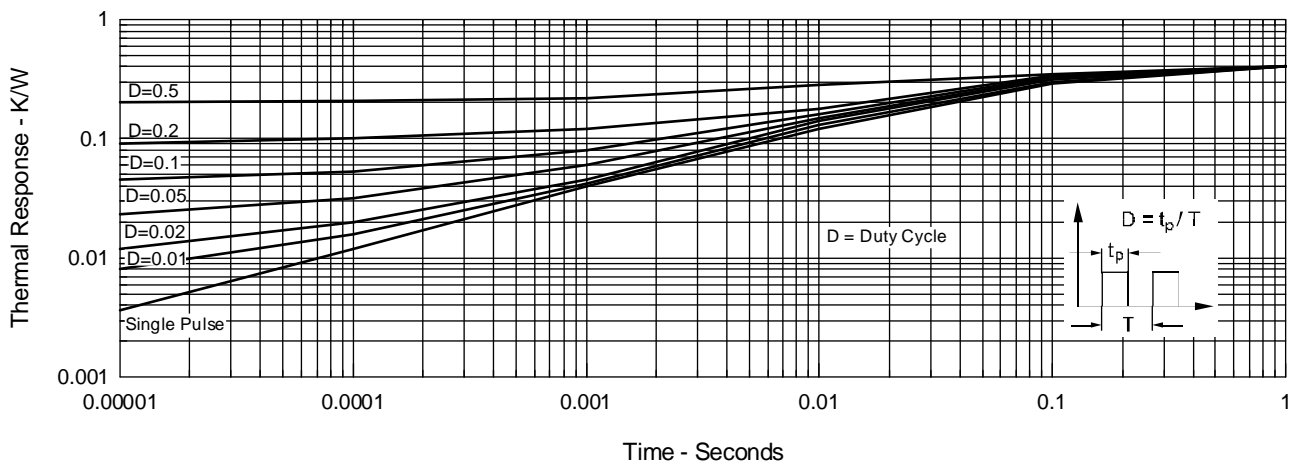



IXYS reserves the right to change limits, test conditions, and dimensions.

IXYS Corporation  
3540 Bassett Street, Santa Clara CA 95054  
Phone: 408-982-0700, Fax: 408-496-0670

IXYS Semiconductor GmbH  
Edisonstr. 15, D-68623 Lampertheim  
Phone: +49-6206-503-0, Fax: +49-6206-503627