



mangOH™ Red

User Guide



41110400
Rev 2
Contents subject to change

Important Notice

Due to the nature of wireless communications, transmission and reception of data can never be guaranteed. Data may be delayed, corrupted (i.e., have errors) or be totally lost. Although significant delays or losses of data are rare when wireless devices such as the Sierra Wireless modem are used in a normal manner with a well-constructed network, the Sierra Wireless modem should not be used in situations where failure to transmit or receive data could result in damage of any kind to the user or any other party, including but not limited to personal injury, death, or loss of property. Sierra Wireless accepts no responsibility for damages of any kind resulting from delays or errors in data transmitted or received using the Sierra Wireless modem, or for failure of the Sierra Wireless modem to transmit or receive such data.

Safety and Hazards

Do not operate the Sierra Wireless modem in areas where blasting is in progress, where explosive atmospheres may be present, near medical equipment, near life support equipment, or any equipment which may be susceptible to any form of radio interference. In such areas, the Sierra Wireless modem **MUST BE POWERED OFF**. The Sierra Wireless modem can transmit signals that could interfere with this equipment.

Do not operate the Sierra Wireless modem in any aircraft, whether the aircraft is on the ground or in flight. In aircraft, the Sierra Wireless modem **MUST BE POWERED OFF**. When operating, the Sierra Wireless modem can transmit signals that could interfere with various onboard systems.

Note: Some airlines may permit the use of cellular phones while the aircraft is on the ground and the door is open. Sierra Wireless modems may be used at this time.

The driver or operator of any vehicle should not operate the Sierra Wireless modem while in control of a vehicle. Doing so will detract from the driver or operator's control and operation of that vehicle. In some states and provinces, operating such communications devices while in control of a vehicle is an offence.

Limitation of Liability

The information in this manual is subject to change without notice and does not represent a commitment on the part of Sierra Wireless. SIERRA WIRELESS AND ITS AFFILIATES SPECIFICALLY DISCLAIM LIABILITY FOR ANY AND ALL DIRECT, INDIRECT, SPECIAL, GENERAL, INCIDENTAL, CONSEQUENTIAL, PUNITIVE OR EXEMPLARY DAMAGES INCLUDING, BUT NOT LIMITED TO, LOSS OF PROFITS OR REVENUE OR ANTICIPATED PROFITS OR REVENUE ARISING OUT OF THE USE OR INABILITY TO USE ANY SIERRA WIRELESS PRODUCT, EVEN IF SIERRA WIRELESS AND/OR ITS AFFILIATES HAS BEEN ADVISED OF THE POSSIBILITY OF SUCH DAMAGES OR THEY ARE FORESEEABLE OR FOR CLAIMS BY ANY THIRD PARTY.

Notwithstanding the foregoing, in no event shall Sierra Wireless and/or its affiliates aggregate liability arising under or in connection with the Sierra Wireless product, regardless of the number of events, occurrences, or claims giving rise to liability, be in excess of the price paid by the purchaser for the Sierra Wireless product.

Patents

This document contains information which is proprietary to Sierra Wireless Inc. and is licensed pursuant to Creative Commons Attribution 4.0 International License.

Document details

Title: mangOH Red User Guide

Author: Sierra Wireless

Source: <http://mangoh.io/>

Copyright

© 2017 Sierra Wireless. Licensed under the Creative Commons Attribution 4.0 license, <http://creativecommons.org/licenses/by/4.0/>



Disclaimer

Indicate any modifications made to the original document.

Trademarks

mangOH™ and the mangOH logo are trademarks of Sierra Wireless.

Other trademarks are the property of their respective owners.

Revision History

Revision number	Release date	Changes
1	February 2017	Document created
2	May 2017	Removed DV2 references, updated to DV3 where needed

Contents

Introduction	6
mangOH Red Components and Accessories	6
Setup and Installation	8
Safe Handling Recommendations	8
Initial Setup	9
Hardware Setup and Features	11
Insert/Remove Embedded Module	11
Power Supply Sources	14
Select Primary Power Supply	15
Connect Battery Backup	16
Connect Antenna(s)	17
SIM, SD, and IoT Expansion Cards	19
Inserting a micro-SIM Card	19
Inserting a microSD Card	21
Inserting/Removing an IoT Expansion Card	22
Peripheral Connectors	23
Raspberry Pi Connector	23
Audio Connection	24
USB Host Connection	25
Control Connections	25
Console USB Connector	25
CF3 USB Connection	26
LED Indicators	26
Physical Switches	28
Reset Switches	28
Buttons	28

mangOH Red Configuration	29
Default Configuration	29
Switch and Jumper Configuration Options	29
Real-time I/O	30
Low-power I/O	30
Module Signals Control	31
Software Setup	34
Install / Update Windows Driver.	34
Install a Terminal Emulator	35
Install the Legato Developer Studio.	35
Download Firmware Updates.	35
Write Your First Program	35

1: Introduction

This user guide explains how to set up and begin using the mangOH™ Red with CF3 (Common Flexible Form Factor) modules.

Once you have the mangOH Red set up, visit mangoh.io for developer documentation, code samples, and other materials.

Note: Described functionality is for mangOH Red (DV3 version). Photographs of mangOH Red (DV2 version) will be updated in the next release of this document.

mangOH Red Components and Accessories

[Table 1-1](#) details the required and optional components needed to begin using the mangOH Red in your development environment. Some of these components are available in mangOH Red development kits (kit contents are supplier-dependent).

Table 1-1: mangOH Red Required and Optional Components

Item	Details
mangOH Red (Included in kit)	Pre-configured development board for CF3 modules 
CF3 module(s) (Included in kit)	The module in the kit includes a cellular modem and an application processor running Legato, an open source embedded platform built on Linux for hosting IoT applications (see legato.io for details). See Table 1-2 on page 7 for compatible Sierra Wireless modules.  <hr/> <i>Note: Not all supported Sierra Wireless modules include application processors.</i> <hr/>
CF3 module cover and cover removal tool (Included in kit)	Industrial-quality snap-in module cover, plus cover removal tool to disconnect the cover from the mangOH Red <i>Note: The cover and tool shown are for WP-series modules. A similar cover and tool (not displayed) are used for HL-series modules.)</i> 
Micro-USB cables (Included in kit)	Connect computer to the mangOH Red for communication and to provide power for non-transmitting tests. 

Table 1-1: mangOH Red Required and Optional Components (Continued)

Item	Details
Antenna (Included in kit)	Main RF antenna included. Additional antennas may be connected for Diversity and Wi-Fi/Bluetooth. 
Micro-SIM card (Included in kit)	<ul style="list-style-type: none"> Sierra Wireless micro-SIM card (included) with initial data allocation User-provided micro-SIM with an active account User-provided test card for use with a call box. 
M2 screws (Included in kit)	Two M2 screws included for securing an IoT module
GNSS Antenna (Not included in kit)	Optional antenna may be connected for GNSS reception. 
Audio cable (3.5 mm) (Not included in kit)	Optional audio cable or headset 

The mangOH Red schematic (available at mangoh.io), describes all interfaces supported by the mangOH Red. However, some of these signals are not supported by some CF3 modules.

The following table identifies supported Sierra Wireless CF3 modules and identifies signals that (as of publication date of this document) are currently not supported. Refer to <http://source.sierrawireless.com> for current Product Technical Specification Documents.

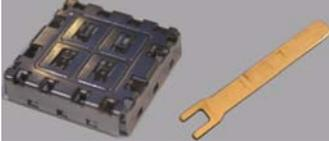
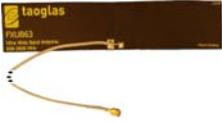
Table 1-2: mangOH-compatible Sierra Wireless CF3 Modules

Supported modules	mangOH Signals Not Supported By CF3 Module			
	Pin	mangOH Signal Name	CF3 Signal Name	Module Signal Name
WP7502 WP7504 WP7601 WP7603 WP8548	43	PWM_OUT	EXT_GPS_LNA_EN	EXT_GPS_LNA_EN
HL75xx HL76xx HL85xx HiLo xxx HL652BRD				

2: Setup and Installation

Safe Handling Recommendations

To help prevent accidental damage to the mangOH Red:

- Use safe ESD-handling practices (such as wearing proper ESD straps) to avoid possible ESD damage.
- Avoid touching the CF3 module (J200). These pins can be damaged if caught on clothing or other materials.

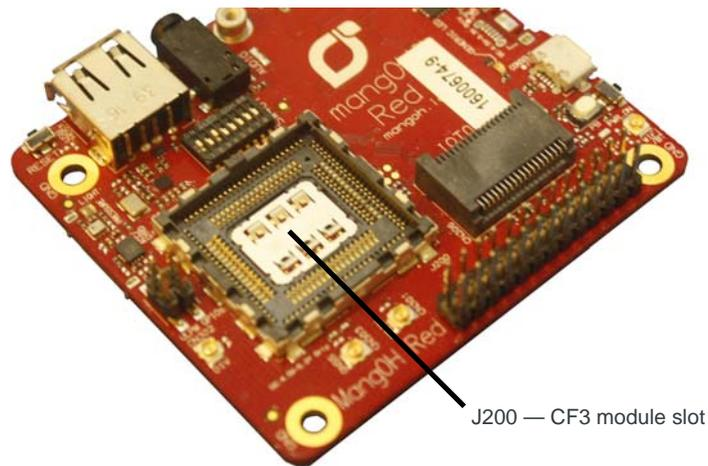

Figure 2-1: Safe Handling Recommendations—CF3 Socket (Do Not Touch)

- Optionally, attach standoffs (not included) to the mounting holes at each corner of the board to avoid damage to components on the bottom side of the board.

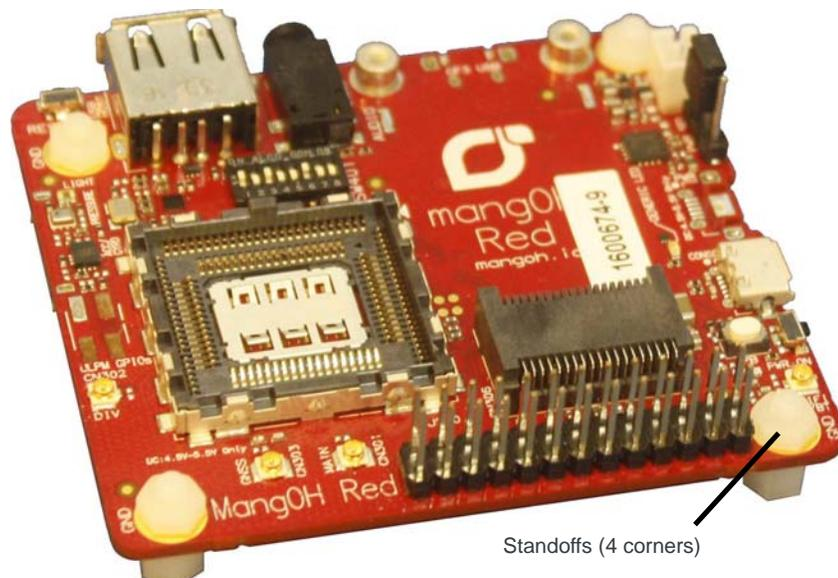

Figure 2-2: Module with Standoffs

Initial Setup

To begin using the mangOH Red, set up your hardware and software:

1. Insert a supported CF3 module in the socket. See [Insert/Remove Embedded Module](#) on page 11.
2. [Select Primary Power Supply](#). See page 15.
3. If you will be establishing a mobile network connection, insert a micro-SIM. See [Inserting a micro-SIM Card](#) on page 19.
4. [Connect Antenna\(s\)](#). See page 17.
5. [Install / Update Windows Driver](#). See page 34.
6. Make sure SW401 pin 1 is ON. This allows the module to power up as soon as power is supplied. (If SW401 pin 1 is OFF, you must press SW402 after power is supplied to power up the module.)

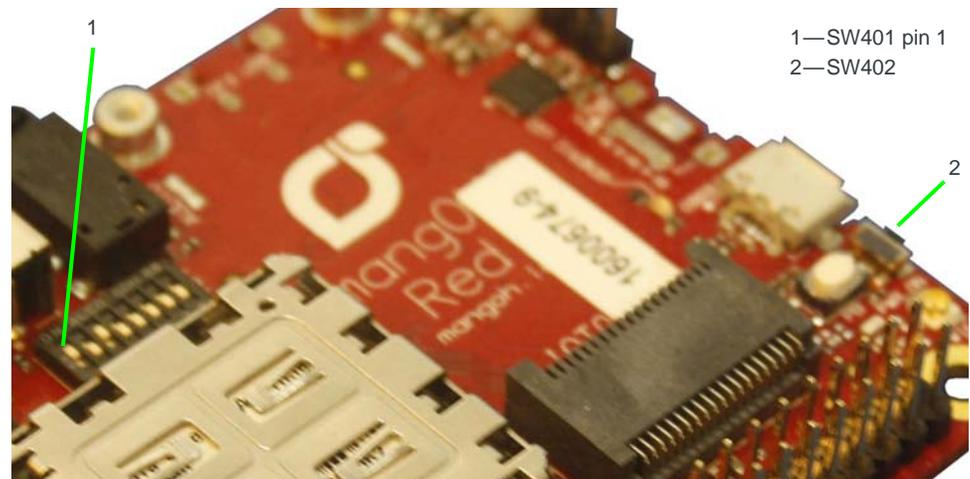

Figure 2-3: Check SW401 Pin 1 Position

7. Power up the mangOH Red—Plug one end of a micro-USB cable into the mangOH Red USB connector that you selected as the power supply in [Step 2](#) and plug the other end into your computer or an AC adapter.

Note: If the mangOH Red is powered from an AC adapter, choose the appropriate micro-USB connector:

- *Console—This leaves the CF3 connector available to access the CF3 module's ECM port, issue AT commands, and download firmware updates to the Wi-Fi/BT (MediaTek Wi-Fi+Bluetooth) chipset.*
 - *CF3 USB—This leaves the Console connector available to access the consoles of the CF3 module or Wi-Fi/BT chipset (switch-selectable), and to download firmware updates to the CF3 module.*
-

If you connected the cable to the correct micro-USB slot, the power LED on the top side of the mangOH Red turns on.

8. Use a second mini-USB cable to connect the remaining mangOH Red USB connector (CF3 USB or Console) to your computer.
9. [Install a Terminal Emulator](#). See page 35.

The mangOH Red is now ready to be used.

- For information on additional hardware features, see [Hardware Setup and Features](#) on page 11.
- For instructions on writing a program, see [Write Your First Program](#) on page 35.

3: Hardware Setup and Features

This chapter describes:

- How to install various components on the mangOH Red
- Available connectors
- How to configure and control features using connectors and switches

Insert/Remove Embedded Module

The mangOH Red has one CF3 module socket. (For a list of supported Sierra Wireless CF3 modules, see [Table 1-2](#) on page 7.)

To insert a CF3 module:

1. Place the mangOH Red face-up.



Figure 3-1: mangOH Red—Top View

2. Hold the module above the socket and line up the polarity marks on the module and socket.



Figure 3-2: CF3 Module Positioning

3. Place the module in the socket. The module should drop into place when you have it aligned properly. Do not insert at an angle as this may damage the socket pins.



Figure 3-3: CF3 Module Inserted

4. Attach the module cover:
 - a. Hold the module cover above the CF3 module and line up the polarity marks on the module and cover.

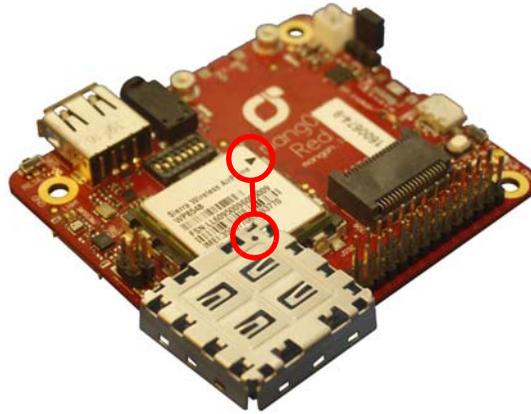

Figure 3-4: Installing Module Cover

- b. Place the cover on the module, then press down carefully until you hear the cover click into place. Make sure all sides of the cover have clicked into place.

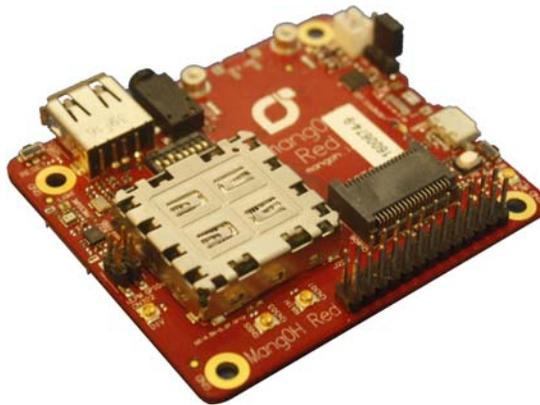

Figure 3-5: Module Cover Installed

To remove a CF3 module:

1. Remove the module cover using the module cover removal tool—Starting at one corner, insert the tool in the pair of holes and carefully pry the cover away from the module.
2. Repeat at the other locations (pairs of pry holes are on each side).



Figure 3-6: Removing the Module Cover

3. Lift the cover off the module.
4. Carefully lift the module straight up out of the socket.

Power Supply Sources

The mangOH Red is powered via either of the board’s micro-USB connectors or an optional backup battery. The micro-USB connectors can connect to a computer’s USB port or, if greater power is required, to an AC adapter.

Table 3-1: mangOH Red Power Supplies

Supply		Details
Primary	CN305—Console USB connector	Provides a serial connection to the mangOH Red.
	CN801—CF3 USB connector	Provides access to CF3 interfaces (ECM port, AT port, etc.)
Backup	CN802—Battery	An optional Li-ion or Li-polymer (3.7 V nominal) rechargeable battery can be installed to power the board if the primary power supply fails.

Select Primary Power Supply

Note: If you want to power the mangOH Red with an AC adapter instead of a computer's USB connector, choose the appropriate micro-USB connector:

- *Console*—This leaves the CF3 USB connector available to access the CF3 module's ECM port, issue AT commands, and download firmware updates to the Wi-Fi/BT chipset.
- *CF3 USB*—This leaves the Console USB connector available to access the consoles of the CF3 module or Wi-Fi/BT chipset (switch-selectable), and to download firmware updates to the CF3 module.

To select the primary power supply:

1. Place the mangOH Red face-up and locate the power select (PWR SEL) jumper pins (CN804).

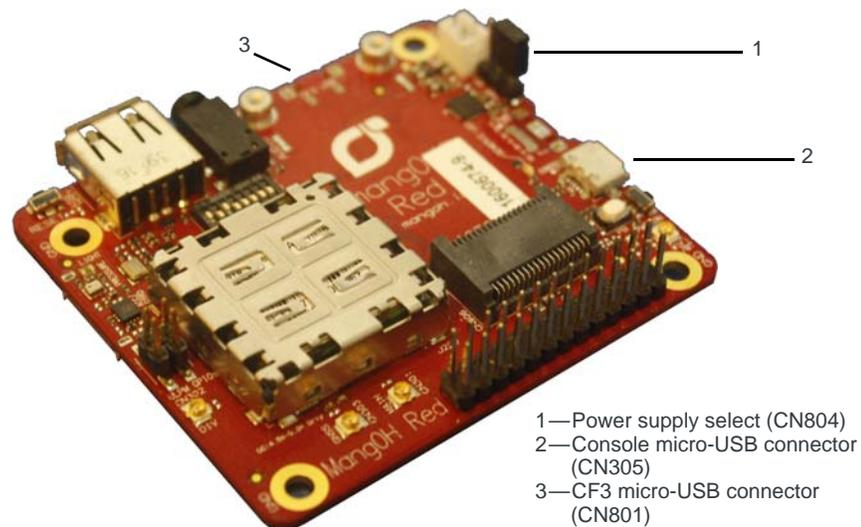
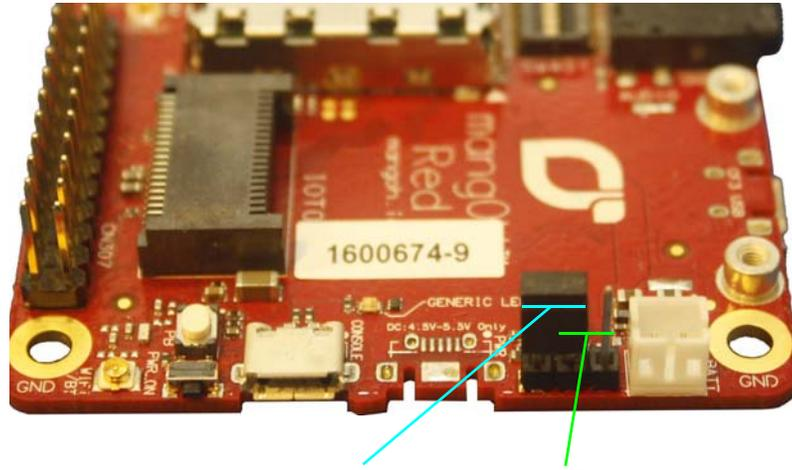

Figure 3-7: Power Supply Select (CN804)

2. Select the power source:
 - CF3 USB connector—Place a jumper across the two pins closest to USB connector CN801.
 - Console USB connector—Place a jumper across the two pins closest to USB connector CN305.



1—Console USB select (left + center pins) 2—CF3 USB select (center + right pins)

Figure 3-8: Power Source Select (Console USB select shown)

Connect Battery Backup

Optionally, you can connect a rechargeable Li-Ion/Li-Polymer battery to the mangOH Red to provide uninterrupted power in the event that the primary power supply fails.

If SW401 pin 5 is ON, the mangOH Red recharges the battery and then provides a trickle charge to maintain the battery's full charge.

To connect a rechargeable Li-Ion/Li-Polymer battery to the mangOH Red:

1. Connect the battery to CN802.

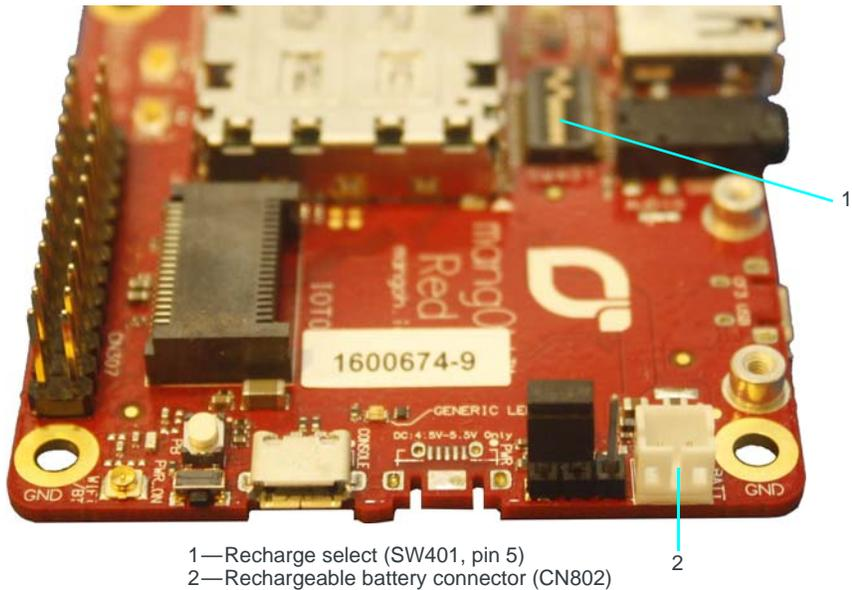

1—Recharge select (SW401, pin 5)
2—Rechargeable battery connector (CN802)

Figure 3-9: Battery Backup Connector

2. If you want the battery to recharge while connected to the board, set switch SW401 pin 5 to ON.

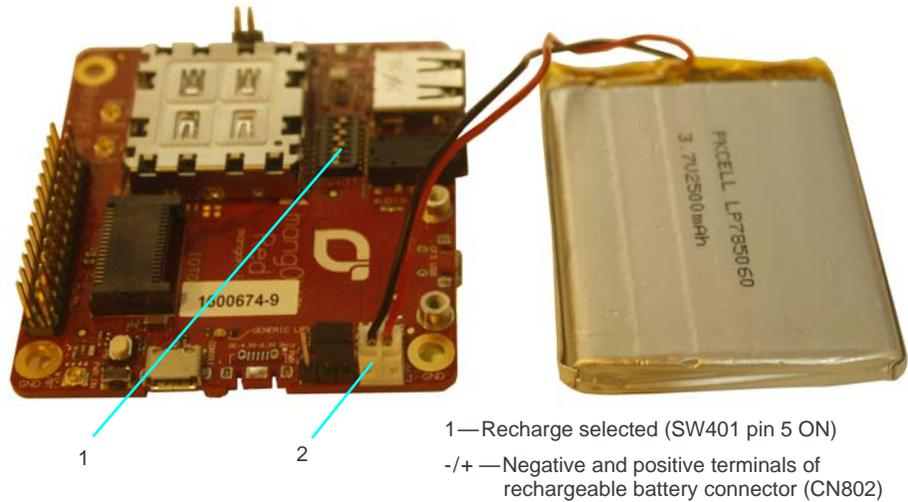

Figure 3-10: mangOH Red With Rechargeable Battery Connected

Caution: If a rechargeable battery is not connected to the board, make sure to set switch SW401 pin 5 to OFF.

Caution: The board is designed to use a rechargeable Li-Ion or Li-polymer battery. Regular (non-rechargeable) batteries are NOT recommended. However, if a regular battery is used, switch SW401 pin 5 MUST be set to OFF, otherwise the battery and possibly the board will be damaged.

Connect Antenna(s)

The mangOH Red includes three antenna connectors for the CF3 module.

Table 3-2: Antenna Connectors

Type	Connector ^a	Details
Main	CN301	Required to establish a mobile network data connection
Diversity	CN302	Used only if CF3 module supports diversity.
GNSS	CN303	<ul style="list-style-type: none"> Required to enable access to GNSS functionality Active 3.3 V bias voltage

a. U.FL connectors

Note: The mangOH Red includes an integrated antenna for the Wi-Fi/BT chipset.

To connect an antenna to the Main, Diversity or GNSS antenna connector:

1. Place the mangOH Red face-up.

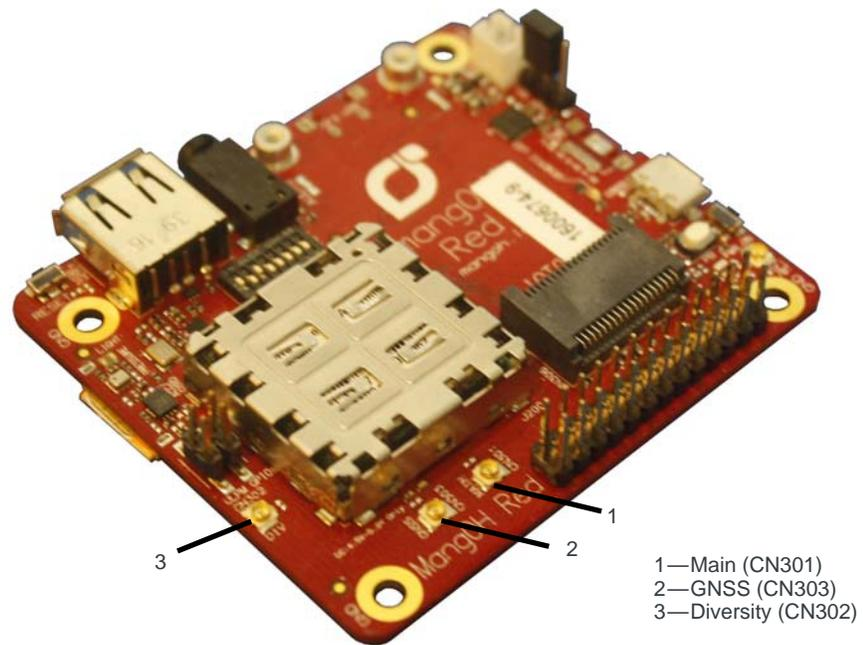

Figure 3-11: Antenna Connector Locations

2. Attach the antenna cable's female connector to the board's male connector and press firmly to get a secure connection.
(Note that female connectors are rated for a limited number of reconnects before the connector wears out, so should be left connected if possible. Use a U.FL extraction tool to put less strain on the connector during removal.)

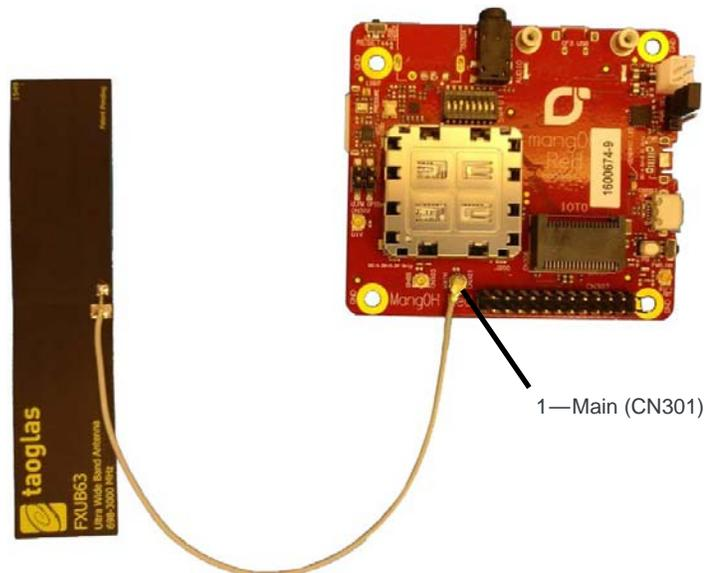

Figure 3-12: Main Antenna Connected

SIM, SD, and IoT Expansion Cards

Inserting a micro-SIM Card

To establish a mobile network connection with a CF3 module, you must install a micro-SIM in the connector on the bottom side of the mangOH Red. Use either of the following:

- Live SIM card with active account (e.g. the Sierra Wireless SIM provided with the kit, or another carrier's activated card), *or*
- Test SIM card for use with a call box (for example, an Agilent 8960 or Rohde & Schwarz CMU200)

To install a SIM card:

1. Place the Dev Kit face-down (as shown).

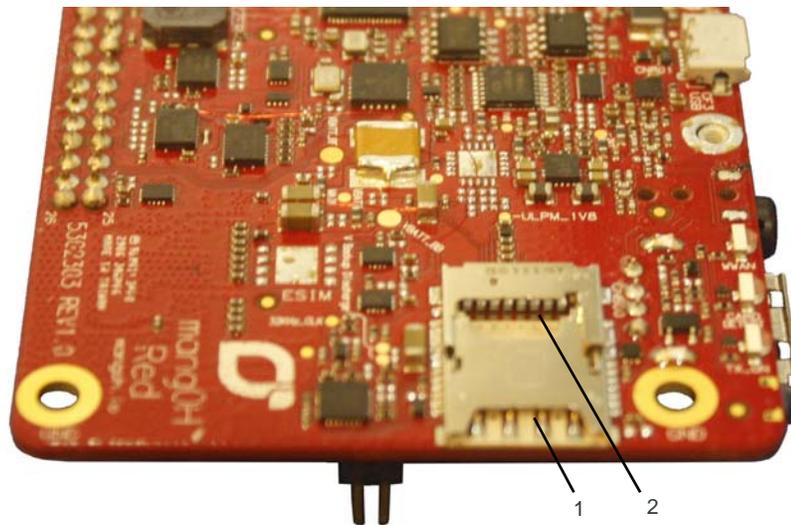

- 1—micro-SIM (CN600—bottom)
2—micro-SD (CN600—top)

Figure 3-13: SIM Connector and micro-SD Locations

2. Insert the SIM card with contacts face-down into the desired slot—note the location of the notched corner of the card in [Figure 3-14](#).

Important: CN600 is a dual-connector—the lower slot is for the micro-SIM, and the upper slot is for a microSD card.

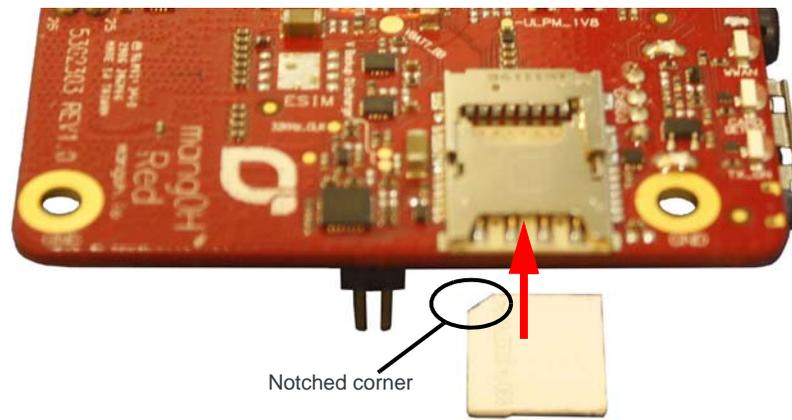

Figure 3-14: SIM—Inserting

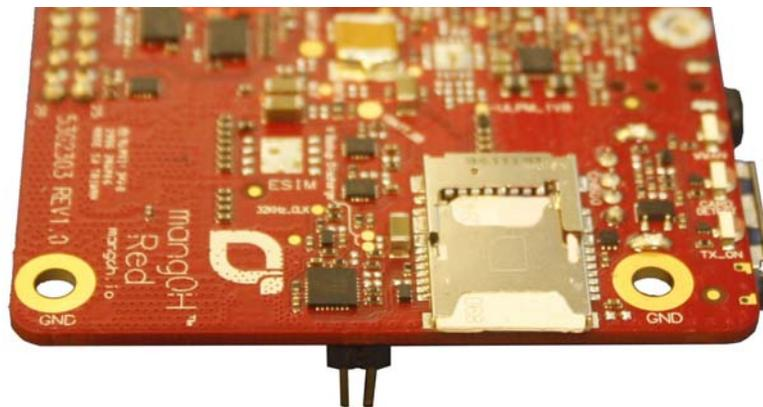
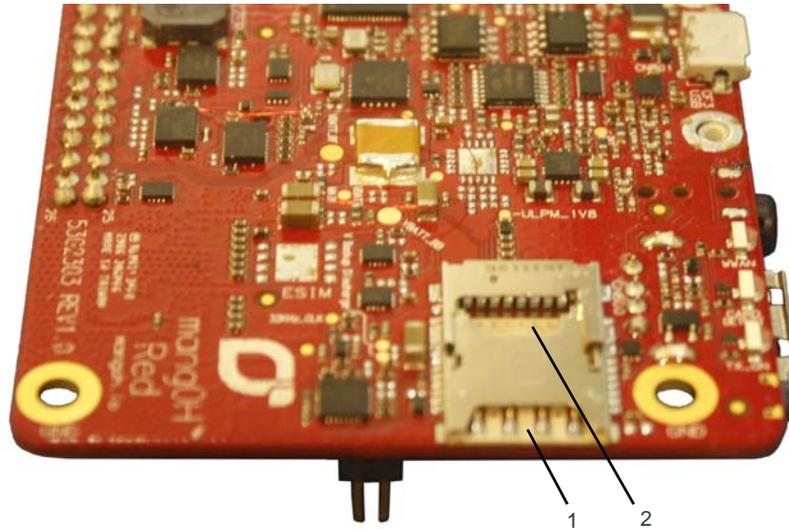

Figure 3-15: SIM—Inserted

Inserting a microSD Card

To install a microSD card:

1. Place the Dev Kit face-down (as shown).



- 1—micro-SIM (CN600—bottom)
2—microSD (CN600—top)

Figure 3-16: micro-SIM/microSD Connector Location

2. Insert the microSD card with contacts face-down into the top slot of CN600.

Important: CN600 is a dual-connector—the upper slot is for the microSD card, and the lower slot is for a micro-SIM.

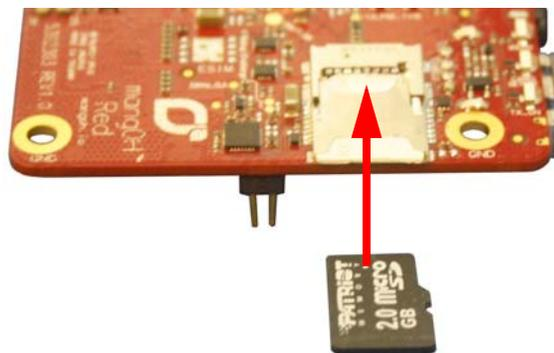

Figure 3-17: microSD—Inserting

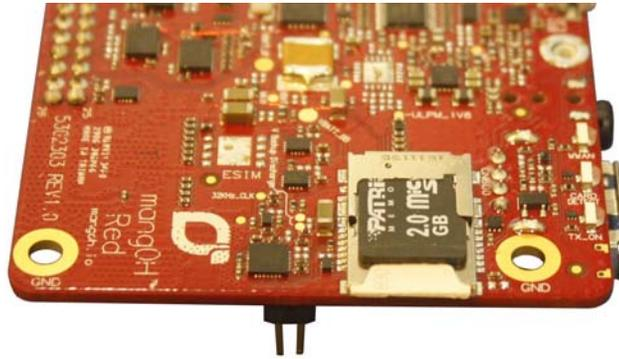

Figure 3-18: microSD—Inserted

Inserting/Removing an IoT Expansion Card

The mangOH Red includes one IoT Expansion Card slot.

Caution: Handle IoT Expansion Cards carefully to make sure components are not accidentally damaged. Hold them by their edges to avoid possible ESD damage.

To install an IoT Expansion Card:

1. Remove power from the mangOH Red (disconnect the micro-USB cable from the computer or AC adapter).

Note: You must remove the power because IoT Expansion Cards are not hot-swappable—the card will be recognized when power is reapplied.

2. Check the expansion card to make sure you know which side is the top. (Expansion cards must not be inserted upside-down.)
3. Slide the expansion card straight into the IoT Connector (CN306).
4. Use two M2 screws (included) to secure the expansion card to the standoffs.

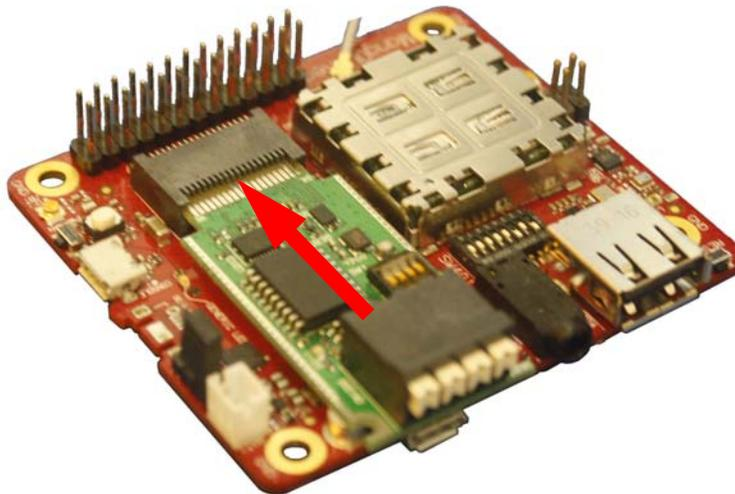

Figure 3-19: IoT Expansion Card Insertion

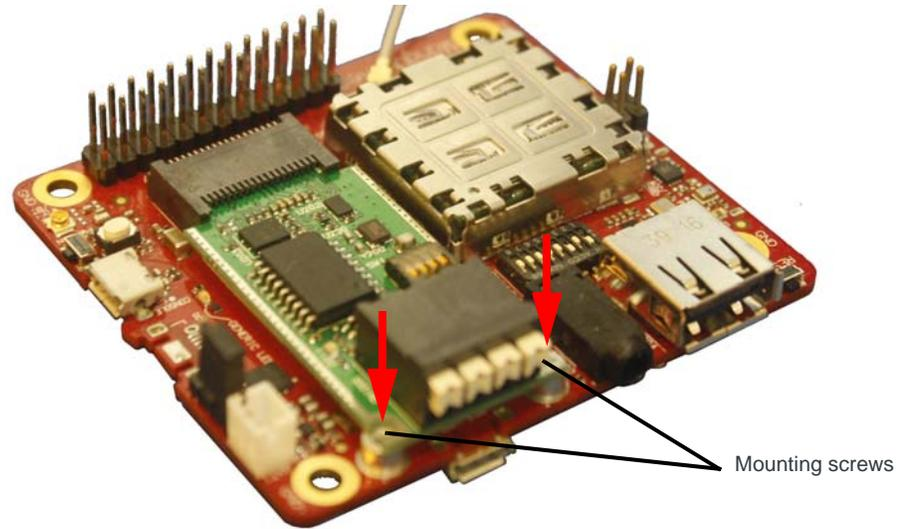

Figure 3-20: IoT Expansion Card Inserted

To remove an IoT Expansion Card:

1. Remove the two screws.
2. Pull the expansion card straight out, using safe ESD-handling practices (such as wearing proper ESD straps).

For detailed IoT Expansion Card slot interface information, refer to the mangOH Red Developer's Guide. For detailed information about expansion cards, refer to the IoT Expansion Card Specification.

Peripheral Connectors

Raspberry Pi Connector

CN307 is a 26-pin connector that provides access to primary Raspberry Pi Rev B pin functions.

Raspberry Pi-compatible connector

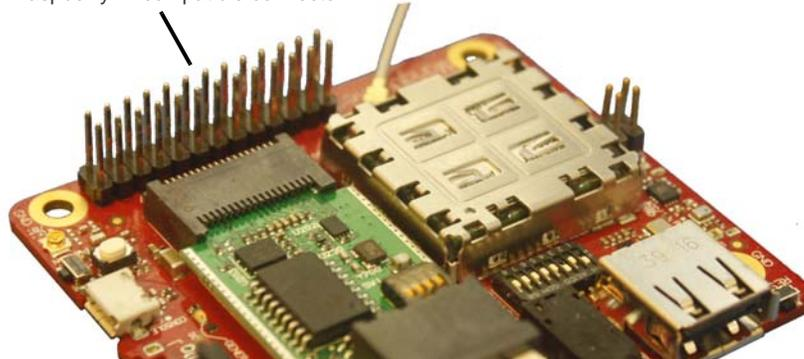

Figure 3-21: Raspberry Pi Connector

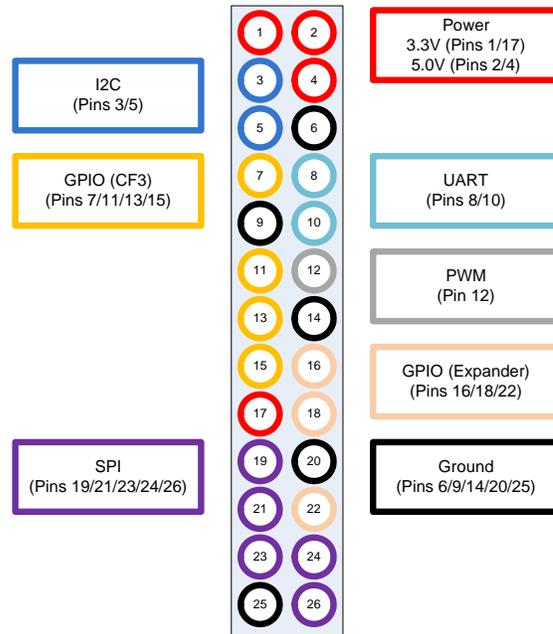

Figure 3-22: Raspberry Pi Connector Signal Groups

Audio Connection

The mangOH Red includes a 3.5 mm audio jack (CN500) for use with audio-enabled CF3 modules. If supported by the CF3 module, the jack can be used to make a voice call.

By default, the audio jack is connected to the onboard mangOH codec, and is configured for use with a CTIA/AHJ-compatible headset. For details, see [Table 3-4](#) on page 29.

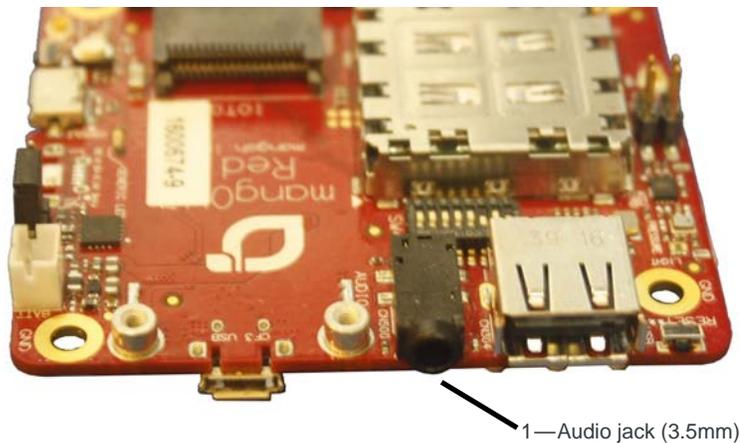

Figure 3-23: Audio Output Jack

USB Host Connection

The mangOH Red includes a USB 2.0 Host port (CN304) for attaching a peripheral device, memory stick, etc.

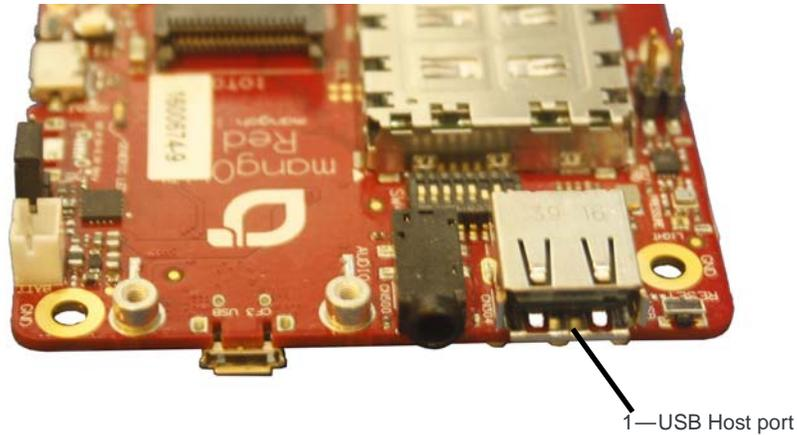

Figure 3-24: USB Host Port

Control Connections

Console USB Connector

The mangOH Red includes a micro-USB 2.0 connector (CN305) for console access. By default, this port is enabled and configured to connect to the CF3 module's two-wire UART interface (UART2).

The connection can be used to access the CF3 module's Linux console (on Smart CF3 modules), the Wi-Fi/BT chipset's console, and to install firmware downloads on the CF3 module or Wi-Fi/BT chipset.



Figure 3-25: Console USB Output Connection

CF3 USB Connection

The mangOH Red includes a micro-USB 2.0 connector (CN801) for access to the CF3 module's interfaces (ECM, AT, etc.), and to install firmware downloads on the Wi-Fi/BT chipset.

By default, this port is enabled and configured to connect to the CF3 module's USB interface.

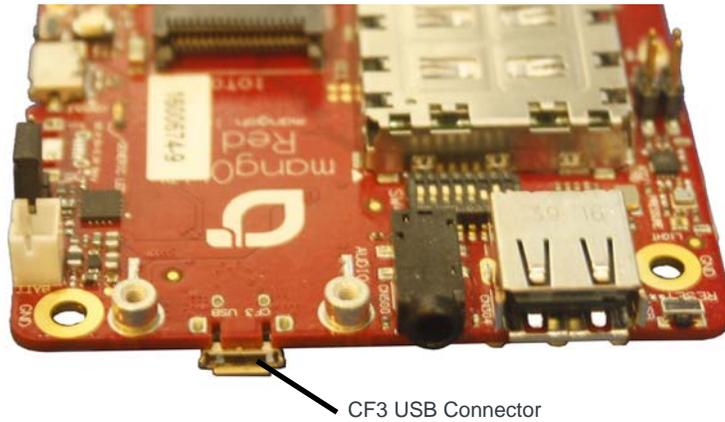

Figure 3-26: CF3 USB Connector

LED Indicators

The mangOH Red includes several LED indicators.

Table 3-3: mangOH Red LEDs

LED	Description
1—Power (VCC_3V3)	D803 - On when power is supplied by any power source (USB, battery)
2—IoT Expansion Card 0	D401 - On when an IoT Expansion Card is installed in slot IOT0.
3—CF3 RF Rx/Tx	D402 - On when the CF3 module is sending (Tx) or receiving (Rx) data
4—WLAN connected	D200 - On when the device is connected to a WLAN <i>Note: Off when low power is enabled.</i>
5—Generic	D410 - Connected to CF3 GPIO34 (via expander WP_GPIO_7_lv), available for user-defined purposes

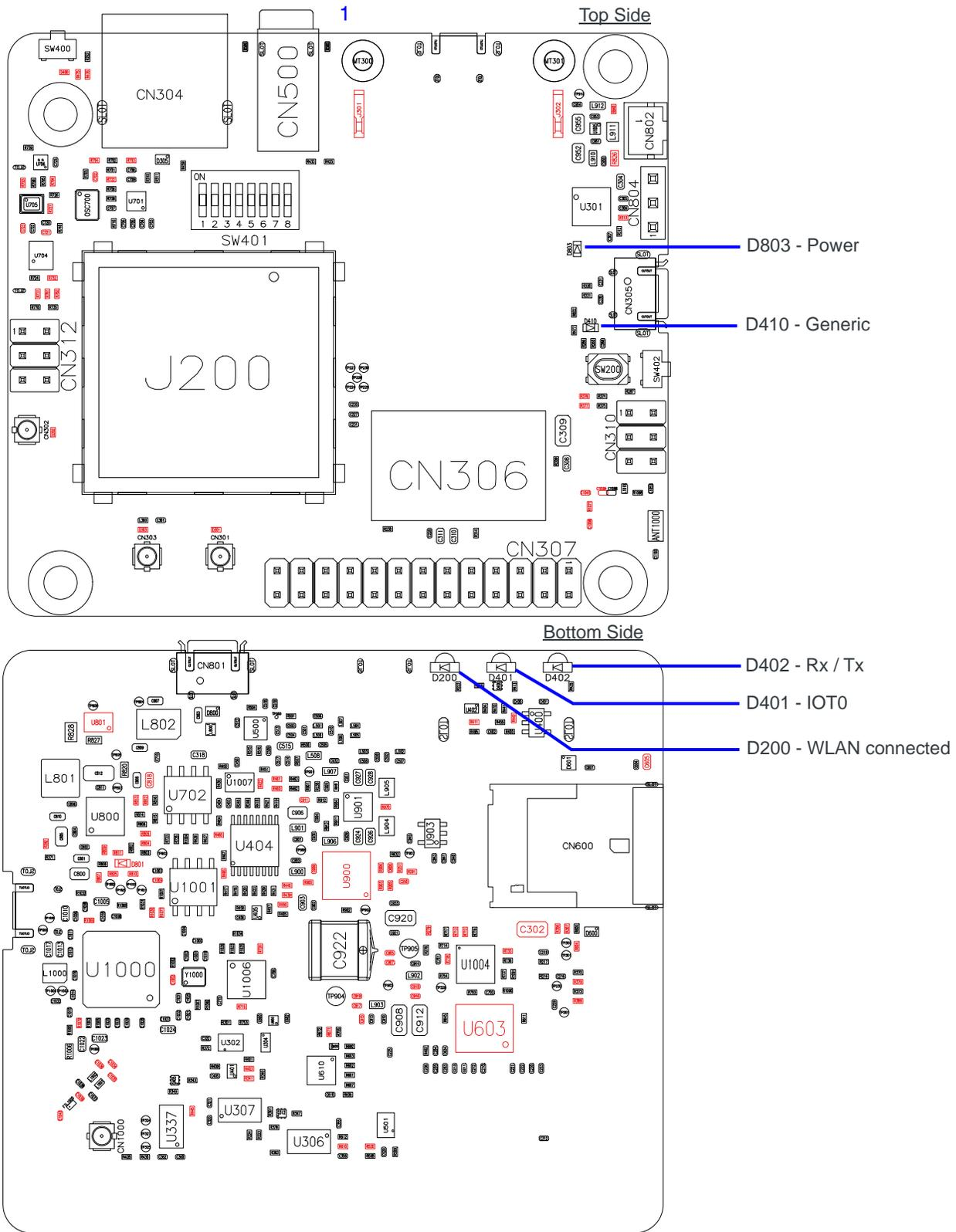

Figure 3-27: LED Indicators

Physical Switches

Reset Switches

The mangOH Red includes two reset switches:

- Board reset (SW400)—Press and hold for 5 seconds to reset the board.

Note: When the board is resetting, the reset signal is held LOW until the CF3 module is fully booted.

- ULPM/PWR_ON (SW402)—If SW401 pin 1 (PWR_ON) is:
 - Off—When power is connected to the board, press and release SW402 to power on the module. After the module powers on, SW402 has no effect.
 - On—When power is connected to the board, power is supplied automatically to the module. SW402 has no effect.

For details on resetting the mangOH Red or specific application blocks, see the mangOH Red Developer's Guide.

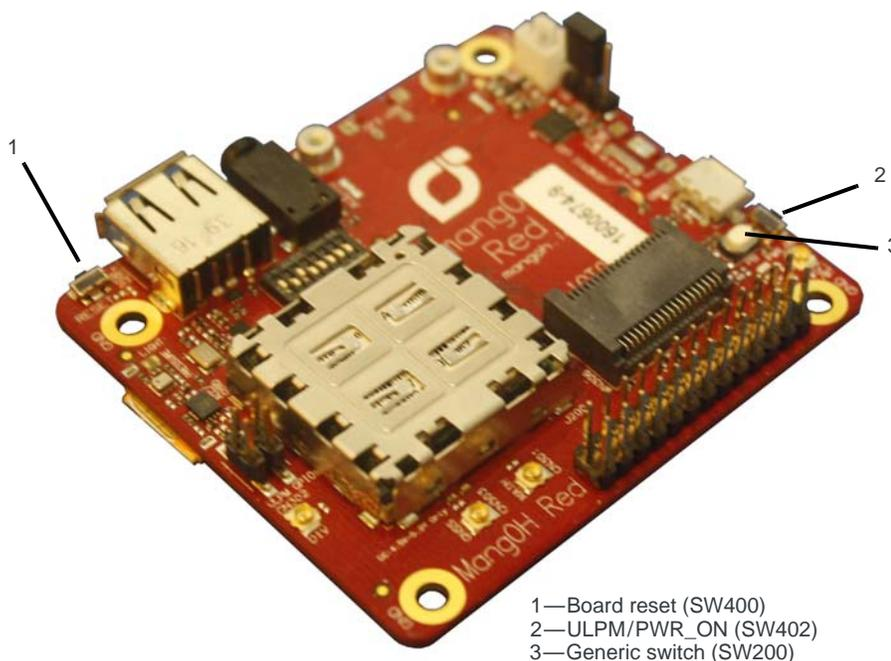

Figure 3-28: Reset Switches

Buttons

The mangOH Red includes one generic button (SW200) for user-defined purposes.

mangOH Red Configuration

Default Configuration

The mangOH Red's default configuration is described in [Table 3-4](#).

Table 3-4: mangOH Red Default Configuration

Component / Switch	Default Configuration / Behavior	Notes
Antenna connectors (CN301, CN302, CN303)	<ul style="list-style-type: none"> U.FL connectors 3.3 V bias voltage for active antennas 	
Audio connector (CN500)	<ul style="list-style-type: none"> Connected to onboard mangOH codec CTIA/AHJ-compatible headset 	
Console USB connector (CN305)	<ul style="list-style-type: none"> Enabled Connected to CF3 module's UART2 	
CF3 USB connector (CN801)	<ul style="list-style-type: none"> Enabled Connected to CF3 module's USB interface 	
LEDs	All LEDs are enabled and will exhibit their default behaviors	
System reset signal (RESET_IN_N)	Held LOW until CF3 module is fully booted	Peripherals on the mangOH Red are not activated until the module is fully booted.
SIM1 Detect	SIM1 Detect uses physical sensor to detect SIM card insertion/removal	
SD connector (CN600)	Connected to CF3 module	Board can be configured using a software command to connect the module's SDIO signals to IOT1 instead of the SD connector.
Peripheral interfaces (UART, SPI, I2C, etc.)	See the mangOH Red Developer's Guide for details.	
Module Signals Control (SW401)	<ul style="list-style-type: none"> PWR_ON (Dip 1)=ON WIFI_UART1_TX (Dip 2)=OFF VCC_3V7_ULPM (Dip 3)=ON HL_MODE (Dip 4)=OFF BATT_TS+ (Dip 5)=OFF CONS_DIR (Dip 6)=OFF TP1_BOOT (Dip 7)=OFF LowPower_RESET (Dip 8)=OFF 	

Switch and Jumper Configuration Options

The mangOH Red uses several switches and jumpers to configure the board and CF3 module's operation, as detailed below in [Table 3-5](#) through [Table 3-8](#).

To locate these switches and jumpers, see [Figure 3-29](#) on page 32 and [Figure 3-30](#) on page 33.

Table 3-5: CN804—Board Power Select^a

Power supply selection	Jump 1–2	Jump 2–3
Console micro-USB connector (CN305)	Yes	
CF3 USB micro-USB connector (CN801)		Yes

a. Required: Select one option only (Jump 1–2 or Jump 2–3). For details, see [Select Primary Power Supply](#) on page 15.

Real-time I/O

The mangOH Red includes a connector (CN310) that provides access to the board’s Wi-Fi/BT chipset for real-time input/output with sensors and other devices.

Table 3-6: CN310—Real Time I/O

Pin	Signal	Purpose
1	WIFI_I2C0_DATA	I2C bus for sensors and other devices
2	GPIO_1_EXP	User-defined GPIO
3	WIFI_I2C0_CLK	I2C bus for sensors and other devices
4	ADC1_WIFI	Analog input
5	GPIO_0_EXP	User-defined GPIO
6	ADC2_WIFI	Analog input

Low-power I/O

The mangOH Red includes a connector that provides GPIOs and ADCs that can continue to be accessed when the CF3 module is in low power mode, and can provide low voltage power to the external sensors/devices connected to those pins.

Table 3-7: CN312—Low Power I/O

Pin	Signal	Purpose
1	WP_GPIO_4_wakeable	May be used to wake CF3 module from sleep mode (if supported by module)
2	VCC_1V8_ULPM	Low power voltage available for external sensors/devices (since main power is not available during low power mode)

Table 3-7: CN312—Low Power I/O (Continued)

Pin	Signal	Purpose
3	WP_GPIO_5_wakeable	May be used to wake CF3 module from sleep mode (if supported by module)
4	ADC1	
5	ADC2	
6	CARD2_DETECT	Wakeup pin for HL77XX modules

Module Signals Control

The mangOH Red uses a multi-function switch (SW401) to control specific signals.

Table 3-8: SW401—Module Signals Control

Signal	Dip	On/Off	State
PWR_ON	1	On (Default)	Enable CF3 module's POWER_ON signal
		Off	Disable POWER_ON signal
WIFI_UART1_TX	2	On	Enable CF3 module's firmware download (recovery) mode. <i>Note: Similar functionality to TP1_BOOT</i>
		Off (Default)	Normal operation
VCC_3V7_ULPM	3	On (Default)	While in ULPM, CF3 module and accessories receive power.
		Off	While in ULPM, only the CF3 module and accessories receive power.
HL_MODE	4	On	When combined with LowPower_RESET, indicates that board is in HL mode.
		Off (Default)	When combined with LowPower_RESET, indicates that board is in WP mode.
BATT_TS+	5	On	Enable backup battery charging.
		Off (Default)	Disable backup battery charging.
CONS_DIR	6	On	Console USB connector accesses the Wi-Fi/Bluetooth module's console. <i>Note: To download firmware to the Wi-Fi module, set CONS_DIR OFF and WIFI_UART1_TX ON.</i>
		Off (Default)	Console USB connector access the CF3 module's console.
TP1_BOOT	7	On	Enable CF3 module's TP1 (boot) signal functionality. Pull the signal low to enter download mode for firmware updates.
		Off (Default)	CF3 module functions normally.

Table 3-8: SW401—Module Signals Control (Continued)

Signal	Dip	On/Off	State
LowPower_RESET	8	On	When combined with LowPower_RESET, indicates that board is in WP mode.
		Off (Default)	When combined with LowPower_RESET, indicates that board is in HL mode.

- 1—Pluggable IoT connector (CN306 (IOT0))
- 2—Power supply select (CN804)
- 3—Battery connector (CN802)
- 4—Signals control (SW401)
- 5—Main antenna (CN301)
- 6—GNSS antenna (CN303)
- 7—Diversity antenna (CN302)
- 8—Wi-Fi/Bluetooth antenna (ANT1000)
- 9—USB Host (CN304)
- 10—Audio (CN500)
- 11—Console micro-USB connector (CN305)
- 12—Raspberry PI RevB-compatible header (CN307)
- 13—Generic button (SW200)
- 14—PWR_ON switch (SW402)
- 15—Reset switch (SW400)
- 16—CF3 module socket (J200)
- 17—Real Time I/O (CN310)
- 18—Low Power I/O (CN312)

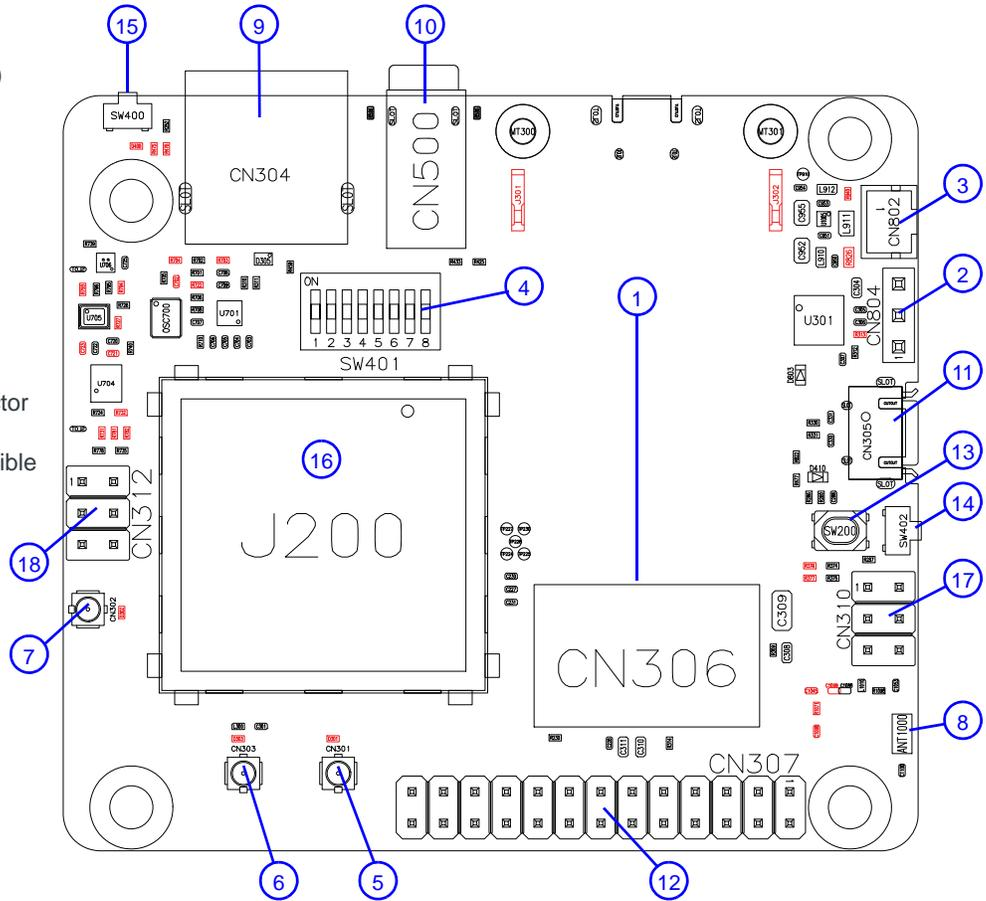

Figure 3-29: mangOH Red Assembly—Top Side Switches/Connectors

Note: For reference only. For latest schematic, visit mangoh.io.

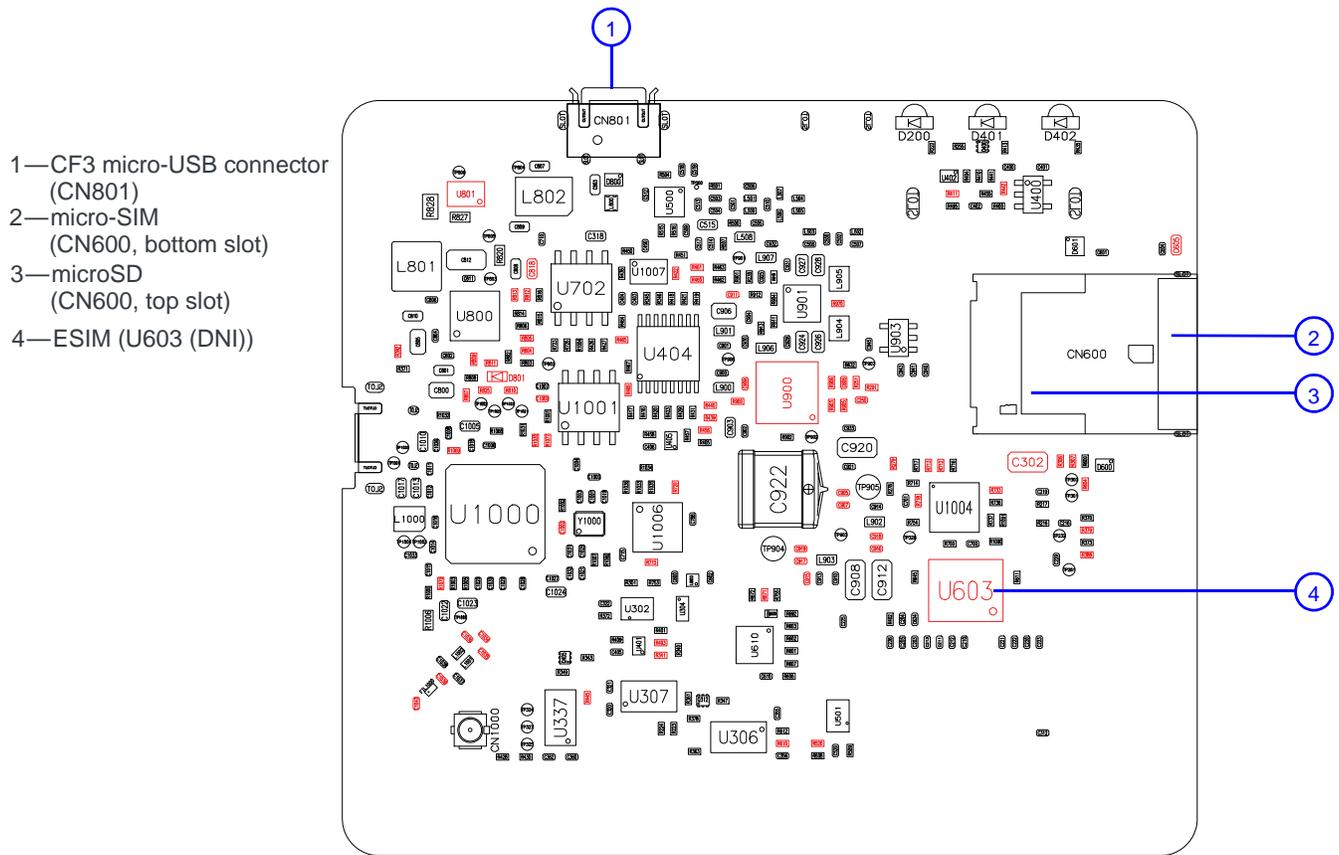

Figure 3-30: mangOH Red Assembly - Bottom Side Connectors

Note: For reference only. For latest schematic, visit mangoh.io.

4: Software Setup

This chapter describes software resources that you will need on your computer to access the mangOH Red and develop applications for its CF3 module.

Sample applications and instructional materials are available from the sites mentioned in this chapter. For detailed information on developing for the mangOH Red, see the mangOH Red Developer’s Guide and related documents (available from mangoh.io).

Install / Update Windows Driver

If you are using a Windows computer, you must install the Legato driver for the CF3 module that you install in your mangOH Red.

1. Visit mangoh.io to download the Windows driver and driver installation instructions for your CF3 module.
2. Install the Windows driver.
3. When the mangOH Red is connected via USB to the computer, display the Device Manager (Control Panel > System > Device Manager).

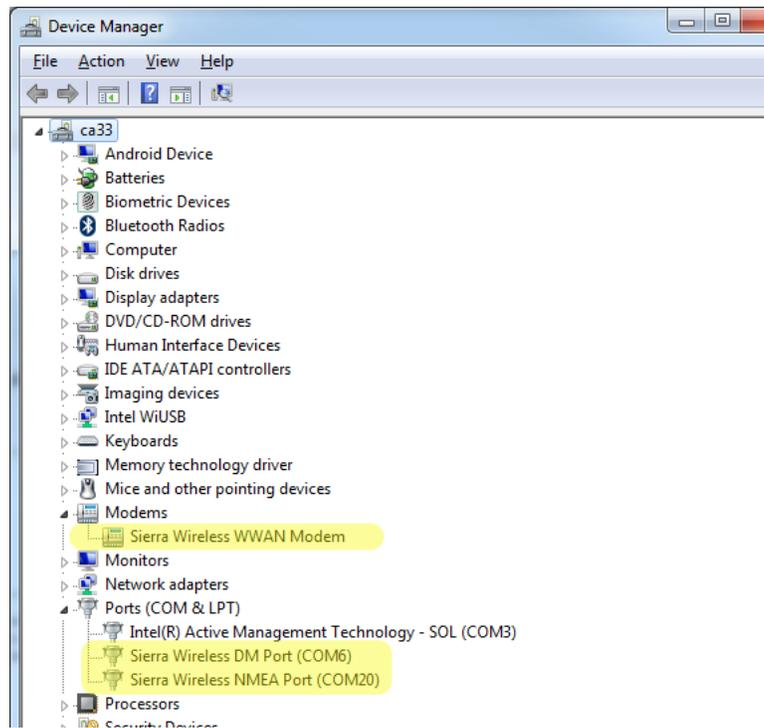

Figure 4-1: Windows Device Manager

If the driver installed correctly, you will see the following items listed:

- Modems > Sierra Wireless WWAN Modem (This is the module in socket J200.)
- Ports [COM & LPT] > Sierra Wireless AT Command Port
- Ports [COM & LPT] > Sierra Wireless DM Port

- Ports [COM & LPT] > Sierra Wireless NMEA Port (This is the port that you will use to communicate with the module from your terminal emulator.)

Install a Terminal Emulator

To communicate with the mangOH Red, you need a terminal emulator program such as Tera Term or HyperTerminal®.

When you have an emulator installed, use it to establish a console connection to the mangOH Red:

- Port—Serial modem COM port (for Sierra Wireless devices, this is the Sierra Wireless NMEA Port)
- Baud rate—115200

Install the Legato Developer Studio

To create Legato applications for the CF3 module, download and install the Open AT Developer Studio (a Legato IDE) available at mangoh.io.

Download Firmware Updates

Firmware updates will be made available for download from mangoh.io.

Write Your First Program

For instructions on building applications (including writing a 'Hello World' program to test your mangOH Red), and to download sample Legato applications, visit mangoh.io.