

## Getting started with the STEVAL-ISB045V1 2.5 W wireless charger transmitter evaluation kit

### Introduction

The **STEVAL-ISB045V1** evaluation kit includes the STEVAL-ISB045V1T wireless battery charger transmitter evaluation board based on the **STWBC-WA** digital controller, the firmware and the STEVAL-WBCDNGV1 USB-to-UART dongle needed to use the **STSW-STWBCGUI**.

The **STWBC-WA** firmware offers you the flexibility of modifying LEDs or GPIO behavior and customizing I<sup>2</sup>C and UART signals. The layout is based on cost-effective two-layer PCB.

Tools for the **STEVAL-ISB045V1** evaluation kit are available on [www.st.com](http://www.st.com) and allow you to access run time information such as regulation error, frequency or protocol status.

**Figure 1. STEVAL-ISB045V1 evaluation kit**



# 1 Getting started

---

## 1.1 System requirements

To use the [STEVAL-ISB045V1](#) evaluation board with the graphical user interface (GUI), you need:

- a PC with Microsoft® Windows® operating system (XP or later versions)
- NET Framework 4
- a USB-to-UART cable to connect the board to the PC.

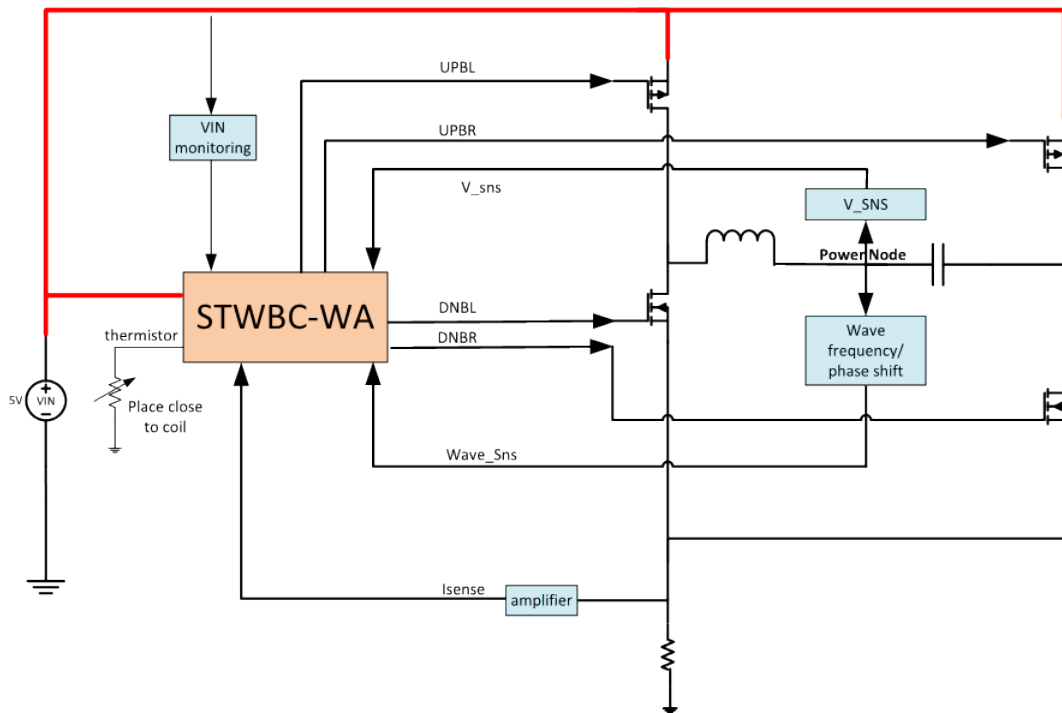
## 1.2 Package contents

- Hardware:
  - an [STEVAL-ISB045V1](#) evaluation kit
- Software:
  - ST-LINK USB driver
  - STVP programming software (integrated in ST\_toolset available on [www.st.com](http://www.st.com))
  - FTDI VCP driver (<http://www.ftdichip.com/Drivers/VCP.htm>)
  - PC GUI installation package

## 2 Hardware description and setup

### 2.1 System block diagram

Figure 2. STWBC-WA block diagram



### 2.2 STEVAL-ISB045V1 wireless transmitter kit overview

The STEVAL-ISB045V1 evaluation kit has the following features:

- [STWBC-WA](#) digital controller
- 2.5 W output power
- Resistive and capacitive modulation
- Foreign object detection (FOD)
- Active presence detector
- Turn-key and firmware APIs
- Total reference design (IC, firmware, GUI and dongle)

Table 1. STEVAL-ISB045V1T electrical performance

Parameter	Input characteristics	Min.	Typ.	Max.	Unit	Notes and conditions
V <sub>in</sub>	Input voltage	4.7	5	5.5	V	
I <sub>in</sub>	Input current		750	900	mA	V <sub>in</sub> = 5 V, P <sub>out</sub> (Rx) = 2.5 W
	Input current (Rx no-load)		200		mA	

Parameter	Input characteristics	Min.	Typ.	Max.	Unit	Notes and conditions
	Input standby current		0.32		mA	1.6 mW
System characteristics						
FS	Switching frequency	130		148	kHz	
Duty cycle		20		50	%	
$\eta$	Full load efficiency		70		%	$V_{in} = 5\text{ V}$ , $P_{out} (Rx) = 2.5\text{ W}$

**Figure 3. STEVAL-ISB045V1T evaluation board: components**

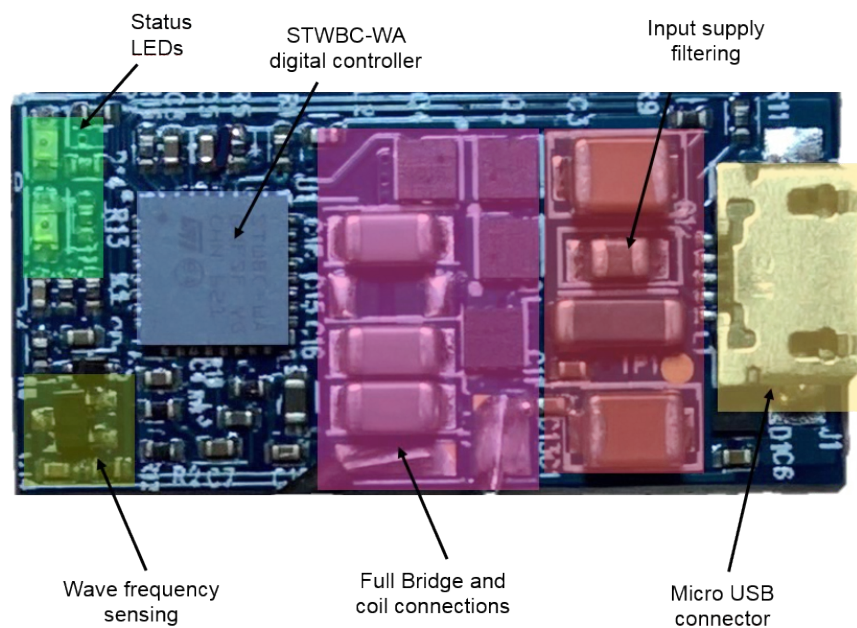
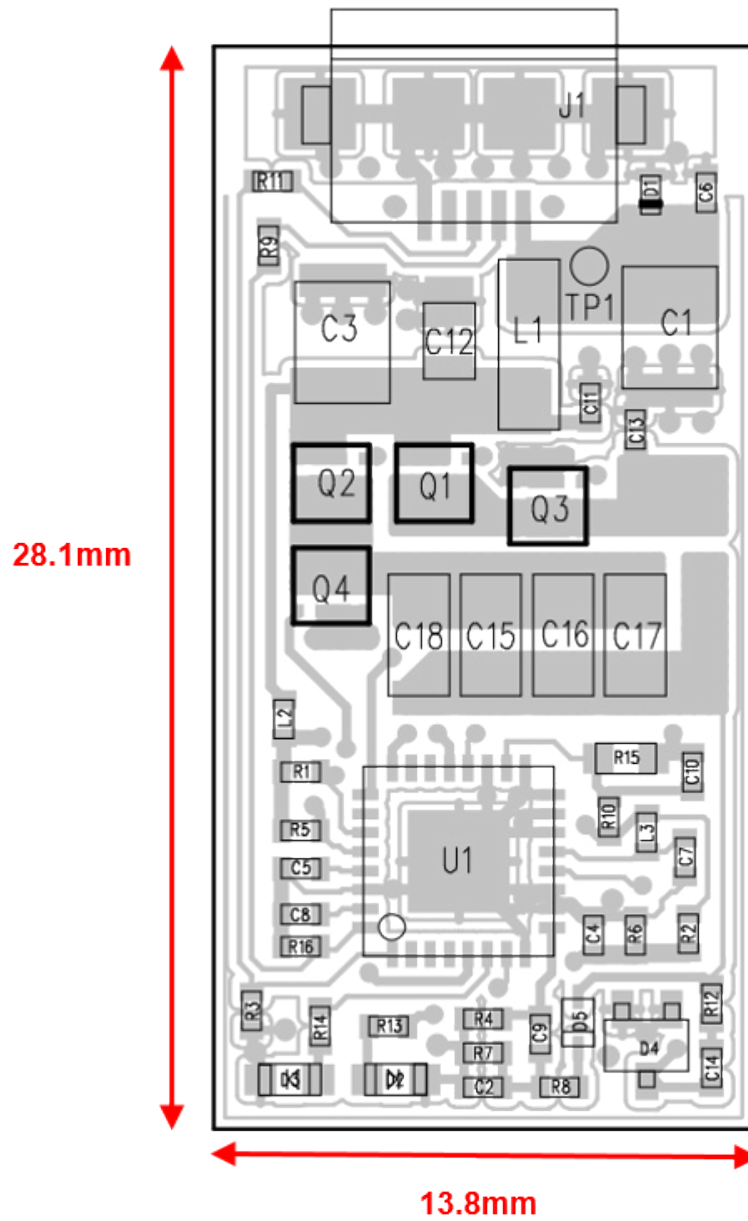
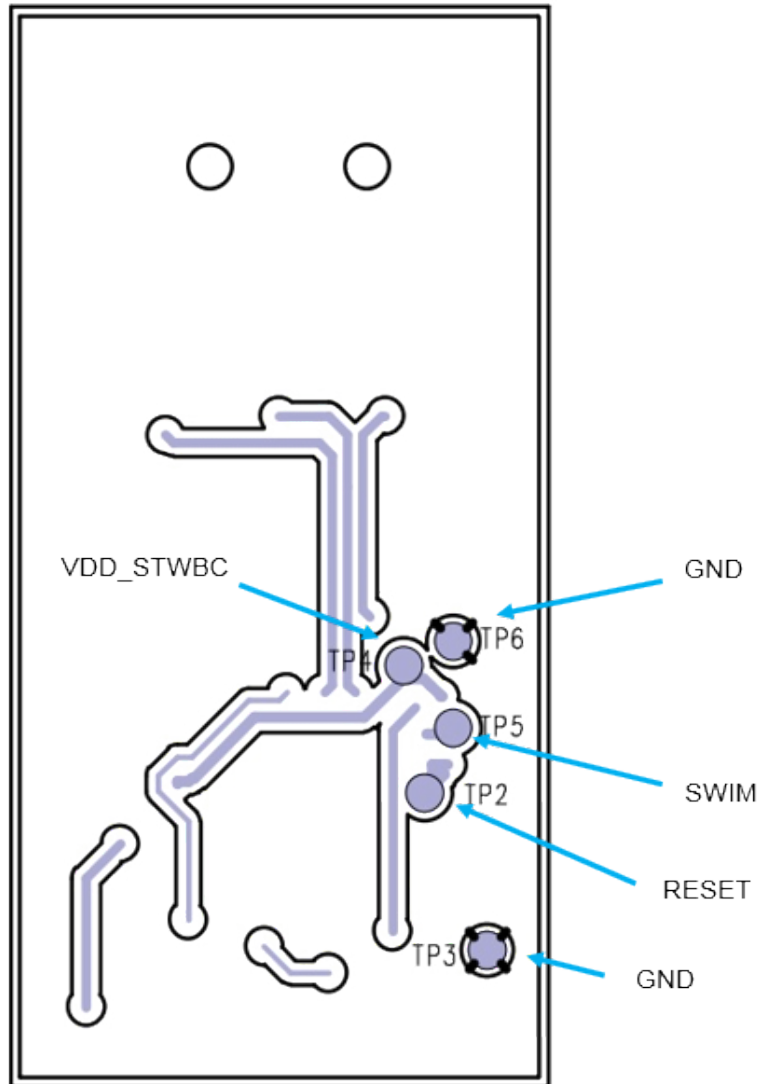


Figure 4. STEVAL-ISB045V1T evaluation board: top reference designators

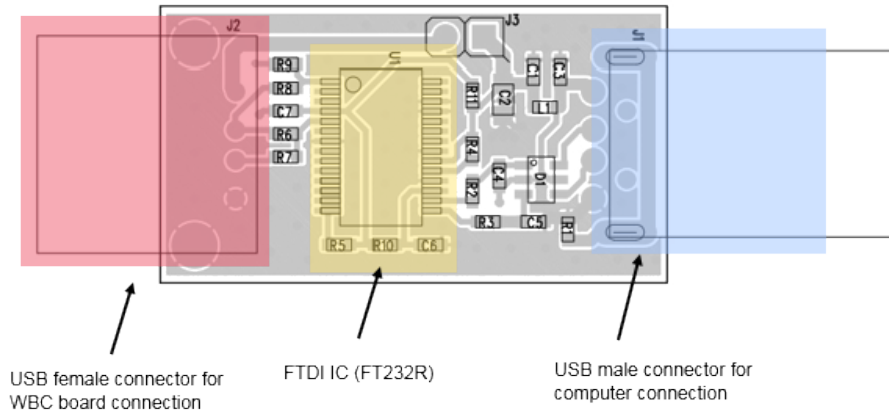
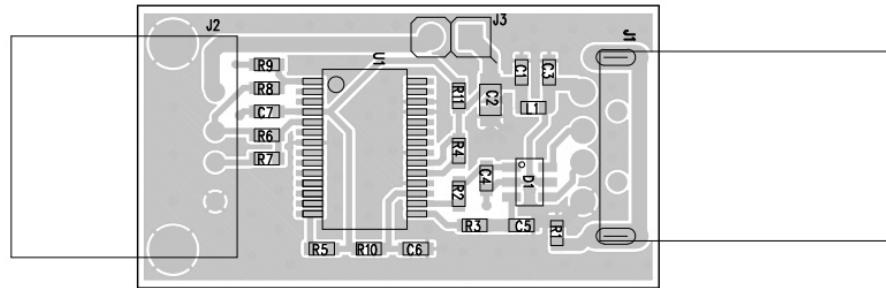


**Figure 5. STEVAL-ISB045V1T evaluation board: bottom reference designators (TP for SWIM connection)**

**Table 2. STEVAL-ISB045V1T evaluation board: connector and test points**

Connector reference	Description
J1	USB to UART connector used for the GUI and for the board supply
TP1	VIN (+5V DC)
TP2	RESET
TP3	GND
TP4	VDD_STWBC
TP5	SWIM
TP6	GND (for SWIM connection)

The STEVAL-WBCDNGV1 USB-to-UART dongle is based on the FT232R IC by FTDI.

It allows monitoring the functions and tuning the parameters of the STEVAL-ISB045V1T transmitter board through the [STSW-STWBCGUI](#).

**Figure 6. STEVAL-WBCDNGV1 dongle components**

**Figure 7. STEVAL-WBCDNGV1: top reference designators**

**Table 3. STEVAL-WBCDNGV1 connectors**

Connector reference	Description
J1	USB connector on computer
J2	USB female connector for UART board connection
J3	Connector for supply connection (5V VBUS from computer if a jumper is set on J3, or external 5V with no jumper)

## 2.3 STWBC-WA pinout and pin description

Figure 8. STWBC-WA pinout configuration

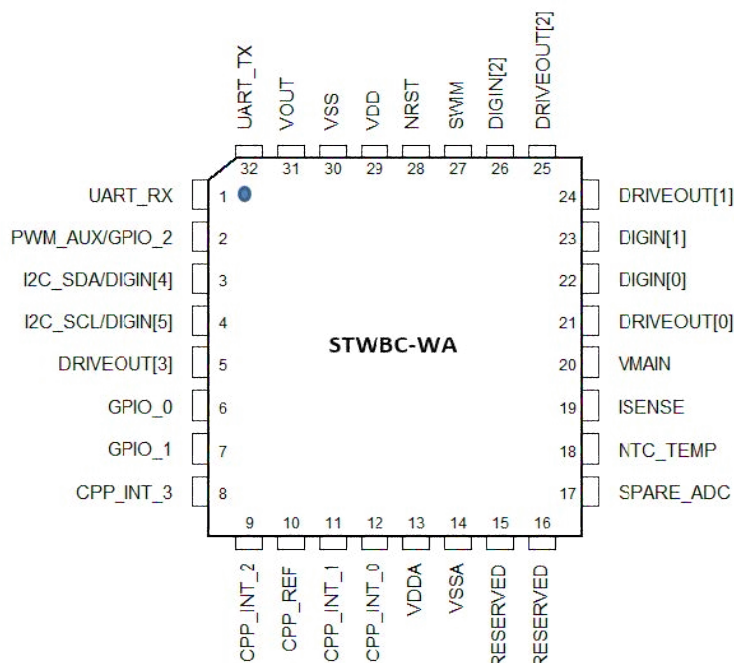


Table 4. STWBC-WA pin description

Pin number	Pin name	Pin type	Turnkey firmware description	Signal name
1	UART_RX <sup>(1)</sup>	DI	Uart RX link on USB connector	USB_DP
2	PWM_AUX/GPIO_2 <sup>(1)</sup>	DO	Not used, must not be connected to any potential	PWM_AUX
3	I2C_SDA/DIGIN[4] <sup>(1)</sup>		Inactive (internal pull up)	I2C_SDA
4	I2C_SCL/DIGIN[5] <sup>(1)</sup>		Inactive (internal pull up)	I2C_SCL
5	DRIVEOUT[3]	DO	Output signal for full bridge right low side driver	DNBR
6	GPIO_0 <sup>(1)</sup>	DO	Digital output for the green light indicator	LEDG
7	GPIO_1 <sup>(1)</sup>	DO	Digital output for the red light indicator	LEDR
8	CPP_INT_3	AI	Connected to GND	CPP_INT3
9	CPP_INT_2	AI	V_SNS symbol detector based on voltage variation	V_SNS
10	CPP_REF	AI	External reference for CPP_INT_3 (if not used, must be tied to GND)	CPP_REF
11	CPP_INT_1	AI	Connected to GND	CPP_INT1
12	CPP_INT_0	AI	WAVE_SNS symbol detector based on delta frequency	WAVE_SNS
13	VDDA	PS	Analog power supply	VDDA
14	VSSA	PS	Analog ground	VSSA
15	TANK_VOLTAGE	AI	Not used, connected to GND	TANK_VOLTAGE
16	VBRIDGE		Not used, connected to GND	VBRIDGE
17	SPARE_ADC <sup>(1)</sup>		Not used, connected to GND	SPARE_ADC
18	NTC_TEMP	AI	Coil temperature measurement with NTC	COIL_TEMP



Pin number	Pin name	Pin type	Turnkey firmware description	Signal name
19	ISENSE	AI	Not used, connected to GND	ISENSE
20	VMAIN	AI	5 V input voltage monitor	VBUS
21	DRIVEOUT[0]	DO	Output signal for full bridge left low side driver	DNBL
22	DIGIN[0] <sup>(1)</sup>		Inactive (internal pull up)	DIGIN[0] <sup>(1)</sup>
23	DIGIN[1] <sup>(1)</sup>		Inactive (internal pull up)	DIGIN[1] <sup>(1)</sup>
24	DRIVEOUT[1]	DO	Output signal for full bridge left high side driver	UPBL
25	DRIVEOUT[2]	DO	Output signal for full bridge right high side driver	UPBR
26	DIGIN[2] <sup>(1)</sup>		Not connected	DIGIN[2] <sup>(1)</sup>
27	SWIM	DIO	Digital I/O for debug interface	SWIM
28	NRST	DI	Reset input monitoring	RESET
29	VDD	PS	Digital and I/O Power supply	VDD
30	VSS	PS	Digital and I/O Ground	GND
31	VOUT	Supply	Internal LDO output	VOUT
32	UART_TX <sup>(1)</sup>	DO	Uart TX link on USB connector	USB_DM

1. API configurable

**Note:** All analog inputs are VDD compliant but can be used only between 0 and 1.2V.

### 3 Download procedure

To download the firmware to the board, install the GUI software which allows complete board monitoring via UART signals. To use the [STSW-STWBCGUI](#), UART signals must therefore be accessible.

#### 3.1 STSW-STWBCGUI software installation

**Step 1.** Install the GUI by launching the STWBC\_GUI\_Setup.msi installation file

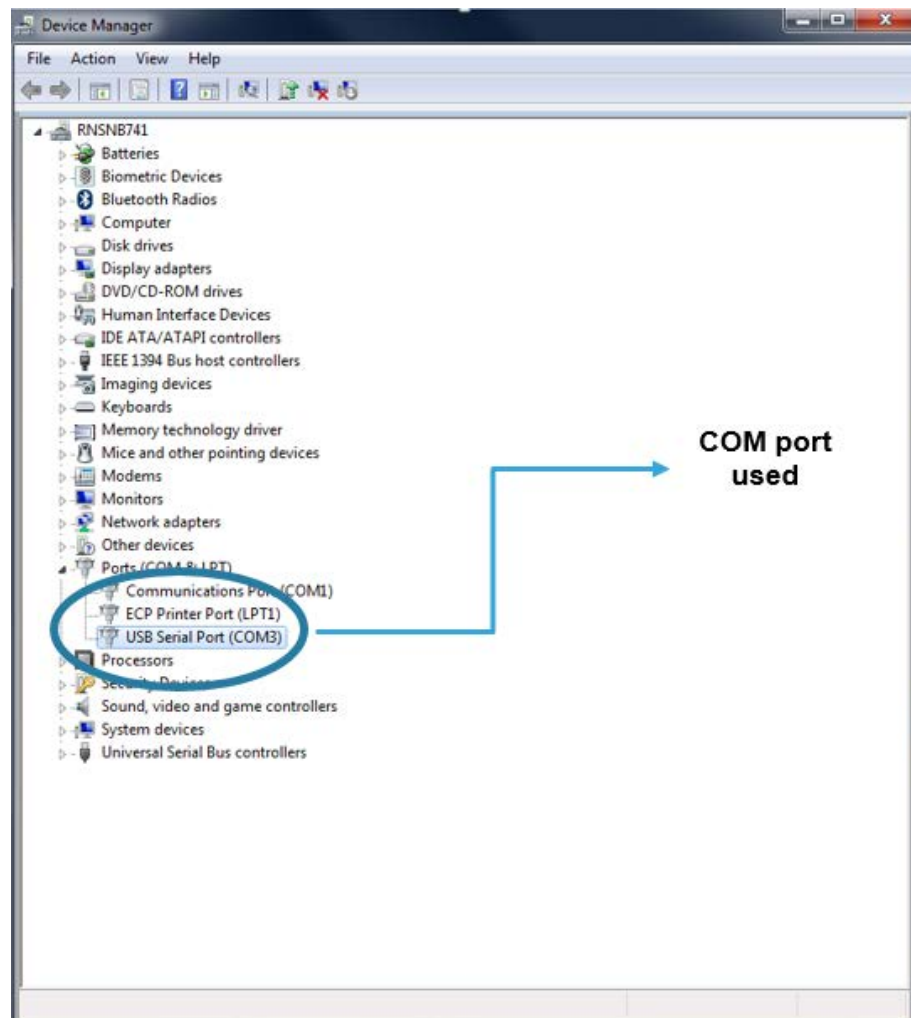
**Figure 9. STSW-STWBCGUI installation file**

Name	Date modified	Type	Size
setup.exe	3/14/2017 11:49 AM	Application	418 KB
STWBC_GUI_Setup.msi	3/14/2017 11:50 AM	Windows Installer ...	2,011 KB

**Step 2.** Connect the wireless power transmitter board to the PC via the USB-to-UART dongle and a cable on J1 connector

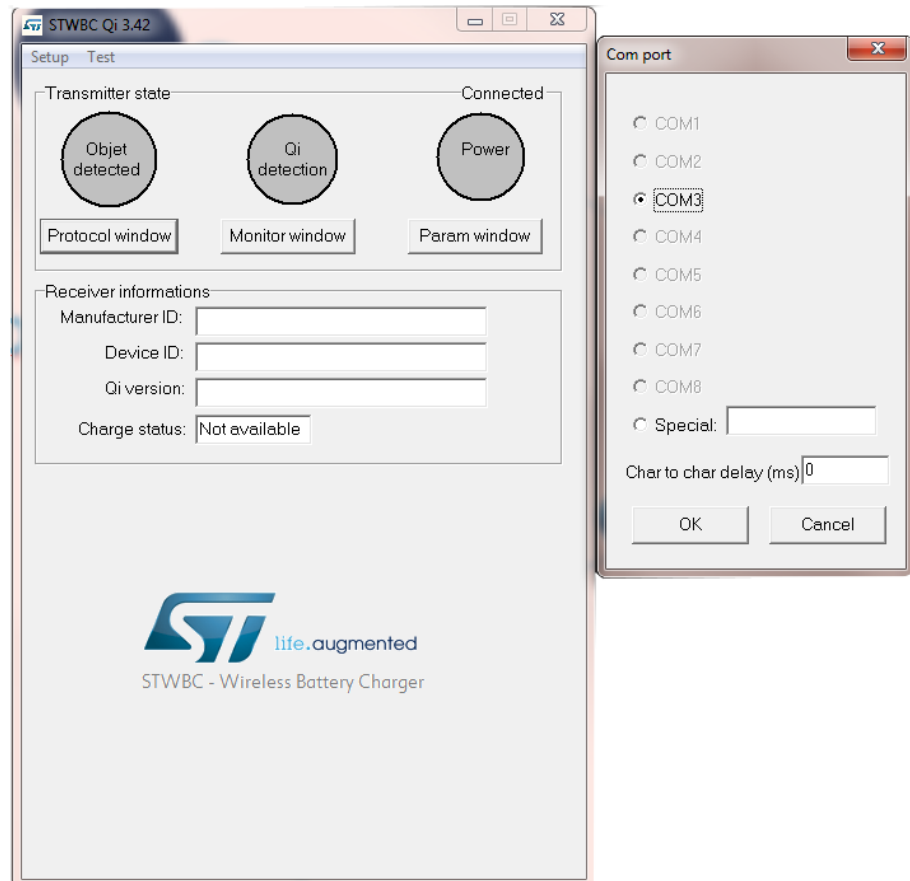
**Step 3.** Check Windows Device Manager to identify the correct port number and select the appropriate USB serial COM port

**Figure 10. Windows Device Manager: COM port selection**



- Step 4.** Enter a specific COM port number (if not listed in the selection window) in the **Special** text box (e.g., "COM12" or the specific syntax \\.\COM12)  
 If the GUI is switched off, ensure that the COM port is not used on your computer. Otherwise, try another USB port.

**Figure 11. STSW-STWBCGUI start screen**



- Step 5.** Press OK.  
 The GUI is ready to run.

## 3.2 Firmware download via STSW-STWBCGUI

The following sections describe the firmware download through the UART connector via STSW-STWBCGUI. The download contains 3 files incorporated in a single \*.cab file.

The **STWBC-WA** implies two different use cases:

1. the chip has never been programmed
2. the chip has already been programmed and need only a firmware update

**Important:** *Strictly follow the specific procedure for each case.*

**Important:**

*Presence detection calibration must be done once after each firmware download (see [Section 5.2 Presence detection calibration procedure](#)).*

### 3.2.1 Download procedure with a new chip (never been programmed)

If the chip has never been programmed, Download mode is enabled by default.

**Step 1.** Connect the USB-to-UART dongle to the computer.

*Note:* Do not connect the transmitter board for the moment.

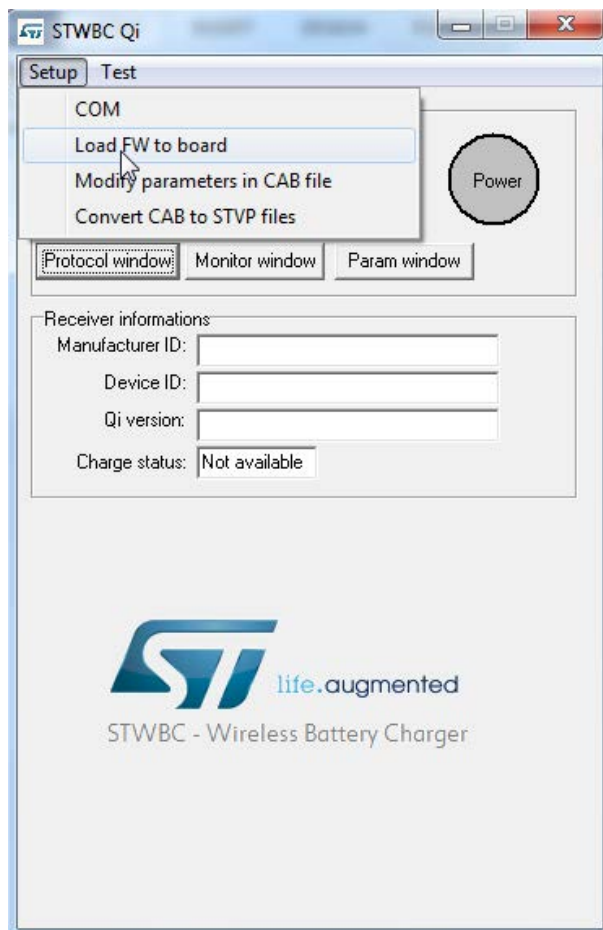
*Note:* Ensure a jumper is placed on the dongle J3 connector to supply the transmitter board via the PC.

**Figure 12. Dongle connection**



**Step 2.** From the GUI, select **Load FW to board** from the setup menu.

**Figure 13. Firmware download via STSW-STWBCGUI**



**Step 3.** As prompted, select the CAB file containing the firmware to download

Figure 14. Firmware file selection message

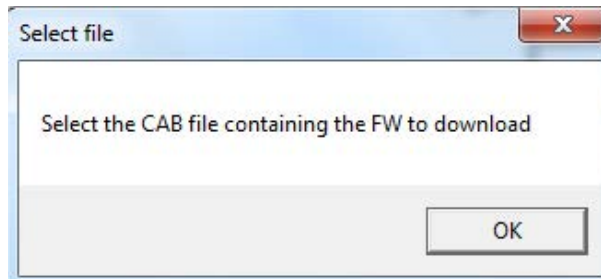
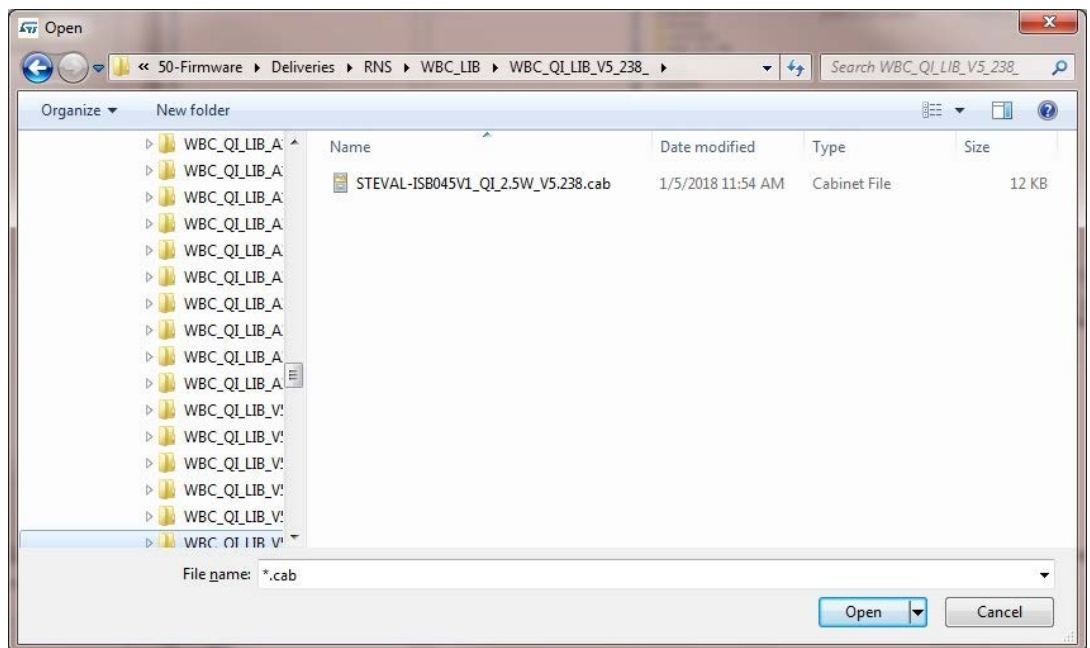
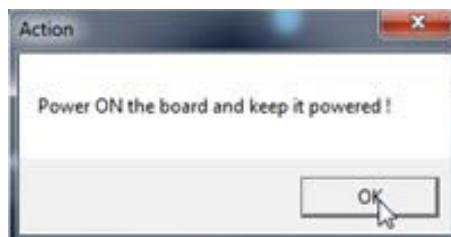


Figure 15. Firmware file selection



Step 4. When the DOS window appears, power the transmitter board on by connecting it to the dongle using a micro-USB cable

Figure 16. Power on message



**Figure 17. STEVAL-ISB045V1 evaluation kit connection**


**Step 5.** Follow the download progress in the DOS window and power off the board when prompted

**Figure 18. DOS window: download in progress**

```

C:\Program Files (x86)\STMicroelectronics\STWBC GUI 3.42\stwbc_loader.exe
Synchronization starting
Synchronization OK
Downloading :
Program : C:\Users\olpalier\AppData\Roaming\STMicroelectronics\STWBC_TMP\program.bin
Parameters : C:\Users\olpalier\AppData\Roaming\STMicroelectronics\STWBC_TMP\parameters.bin
Options : C:\Users\olpalier\AppData\Roaming\STMicroelectronics\STWBC_TMP\options.bin
sending code - OK
sending code - OK
sending C:\Users\olpalier\AppData\Roaming\STMicroelectronics\STWBC_TMP\program.bin_
    
```

**Figure 19. Download success message**


### 3.2.2 Firmware upgrade procedure (chip already programmed)

If a chip has already been programmed with the firmware, Download mode is disabled and a special command needs to be sent to [STWBC-WA](#) to enable Download mode.

- Step 1.** Connect the USB-to-UART dongle to the transmitter board to supply it.
- Step 2.** The STWBC-WA UART Rx/Tx signals are accessible on the transmitter board micro-connector (muxed respectively on USB\_DP and USB\_DM).
- Step 3.** From the STSW-STWBCGUI, select **Load FW to board** from the setup menu (see [Figure 13. Firmware download via STSW-STWBCGUI](#))
- Step 4.** As prompted, select the CAB file containing the firmware to download (see [Figure 15. Firmware file selection](#))
- Step 5.** As prompted, power the board on and keep it powered (see [Figure 16. Power on message](#))
- Step 6.** Follow the download progress in the DOS window and power the board off when prompted (see [Figure 19. Download success message](#))

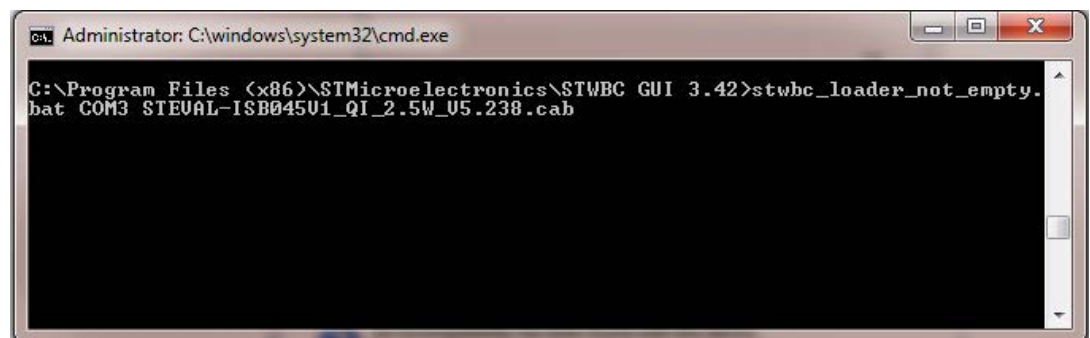
In case of problems in downloading the firmware through UART (for example, firmware corruption during update), refer to [Section 3.6 Erasing firmware procedure using STVP](#).

### 3.3 Firmware download with command line (UART)

#### 3.3.1 Firmware download with written chip

- Step 1.** Ensure a dedicated directory has the following files:
  - STWBC\_Loader.exe
  - stwbc\_loader\_not\_empty.bat
  - enable\_boot.bin
  - “firmware version”.cab
- Step 2.** Starting from the STSW-STWBCGUI folder, run the stwbc\_loader\_not\_empty.bat from the command line, specifying the COM number (e.g. COM2) and firmware filename parameters (“firmware name.cab”).

**Figure 20. STSW-STWBCGUI command line**

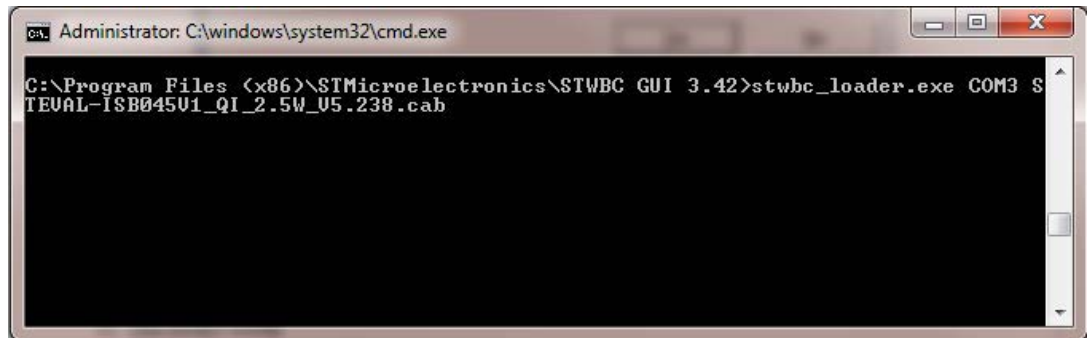


#### 3.3.2 Firmware download with blank chip

If the STWBC-WA memory is erased, the procedure sequence is a bit different.

- Step 1.** Connect the UART cable to the board.
- Step 2.** Select **Load FW to board** from the STSW-STWBCGUI and power the board.
- Step 3.** Execute the command line as per the example below with the appropriate firmware filename.

Figure 21. STSW-STWBCGUI command line with blank chip



Note: If the COM port is > COM8, use the syntax `\\.COMx`, where COMx is the COM port number.

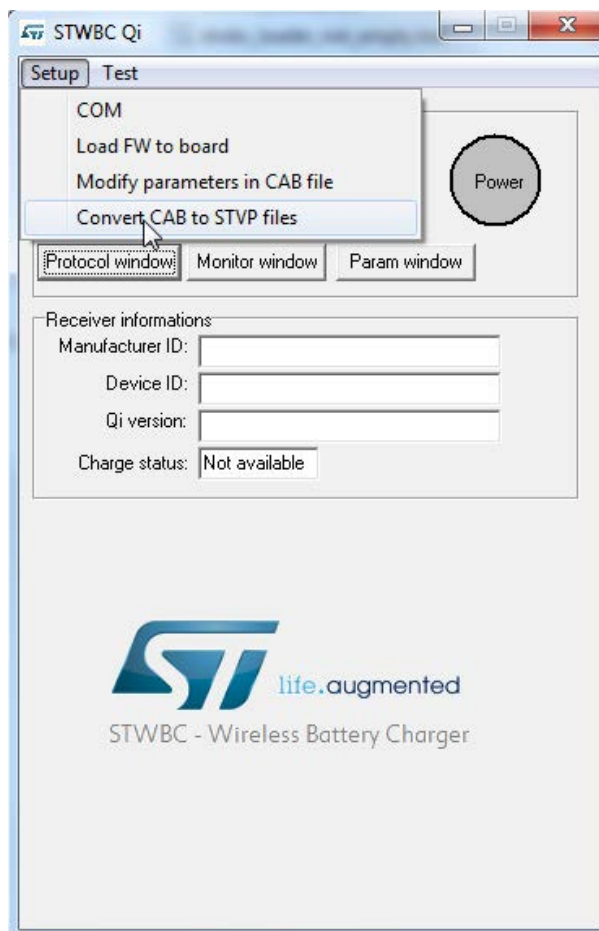
Note: A dedicated tool is available for simultaneous downloads (refer to the [STSW-STWBCFWDT](#) firmware downloader tool).

### 3.4 STVP file creation

To use the STVP to download, you must generate new files from the \*.cab via the [STSW-STWBCGUI](#).

**Step 1.** Select the convert **CAB to STVP files** command from the STSW-STWBCGUI setup menu.

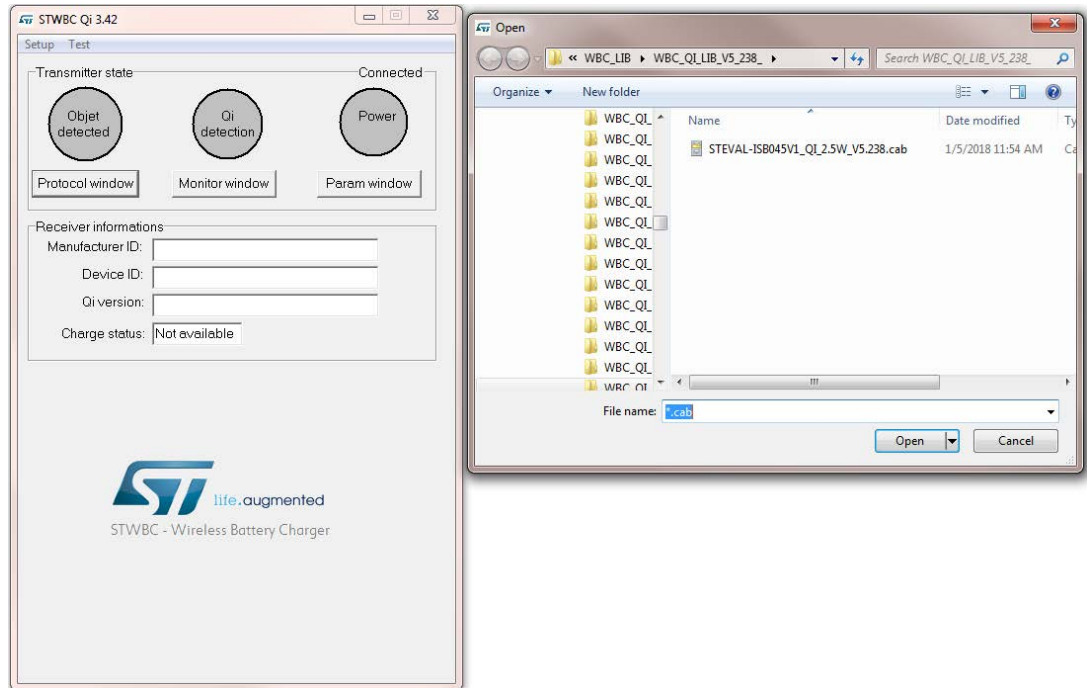
Figure 22. STSW-STWBCGUI: convert CAB to STVP files



**Step 2.** Follow the prompt to select the appropriate cab file.

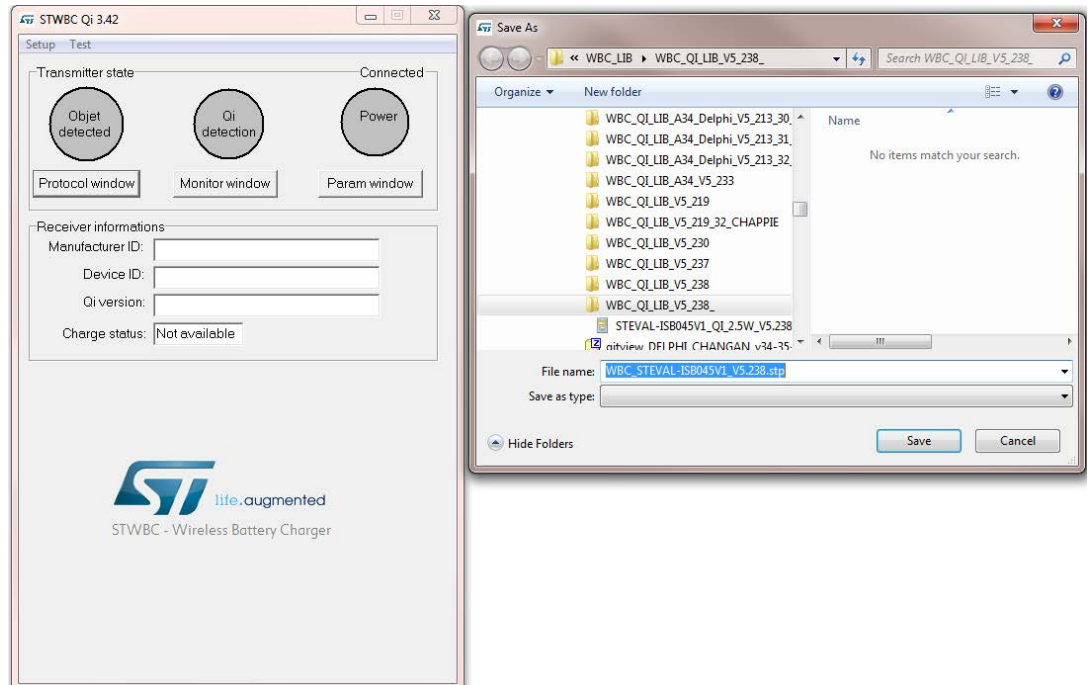


Figure 23. Selecting the CAB file to be converted

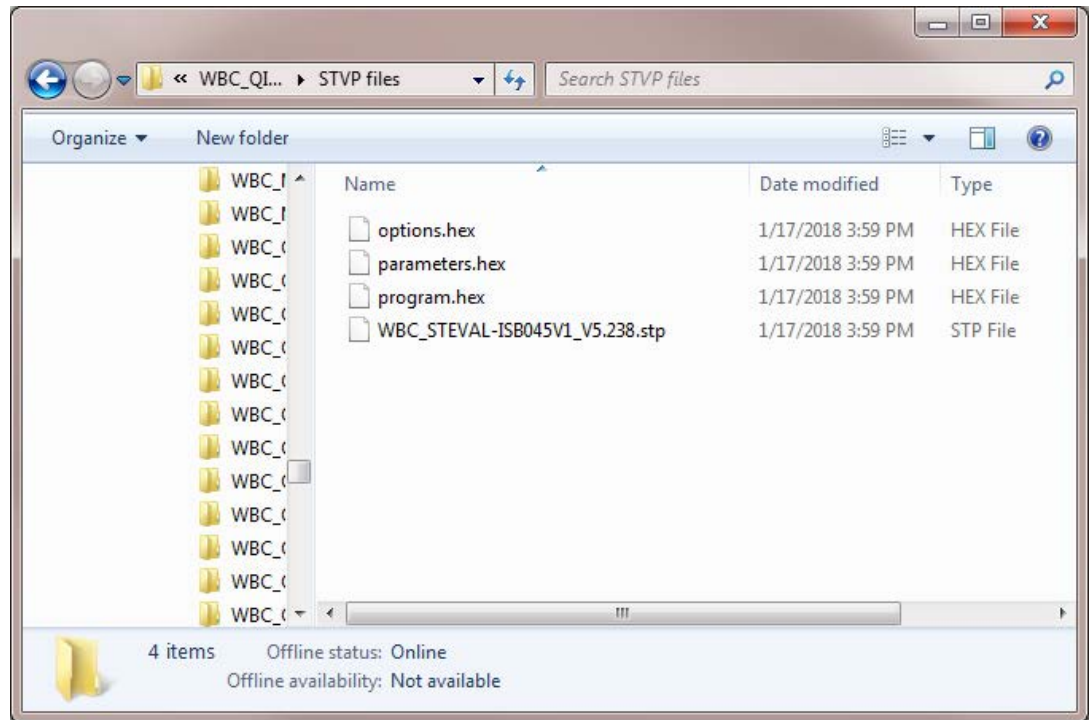


Step 3. Follow the prompt to provide the project file name.

Figure 24. Selecting the STVP project file name



Four files are generated as shown below.

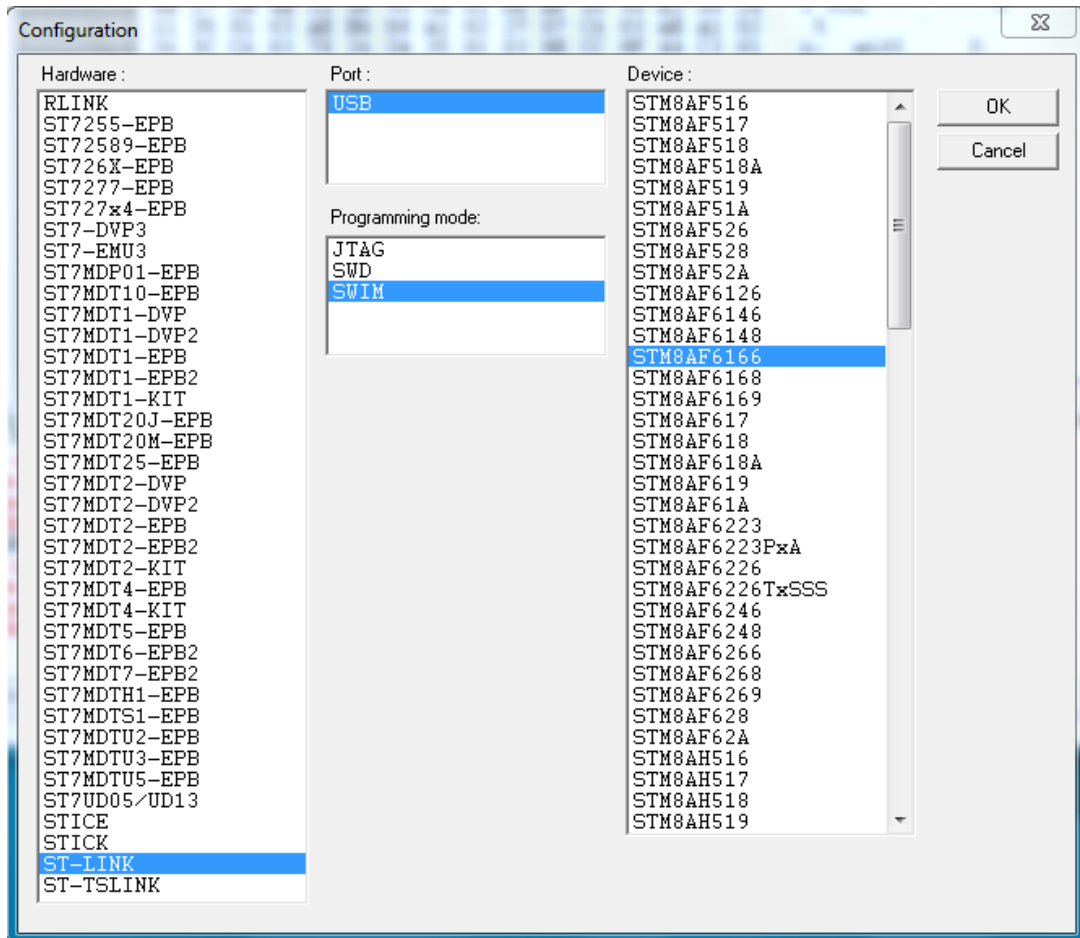
**Figure 25. STVP project files**


*Note:* Refer to [STSW-STWBCFWD](#) STWBC firmware downloader tool for further details.

### 3.5 Firmware download with STVP

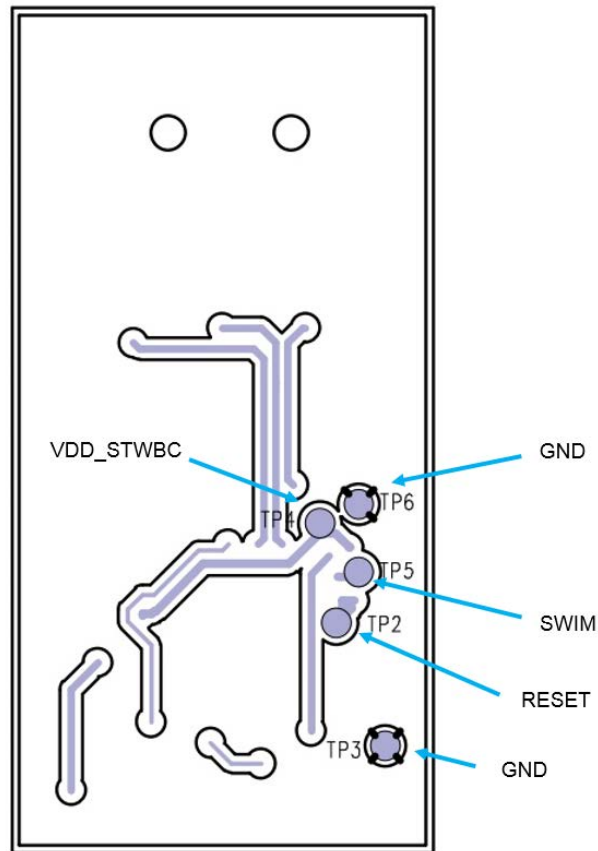
Requirements:

- ST-LINK USB driver installed
- ST STVP programming tool installed
- ST-LINK hardware tools connected to the transmitter board SWIM signals
- STVP configured as shown below

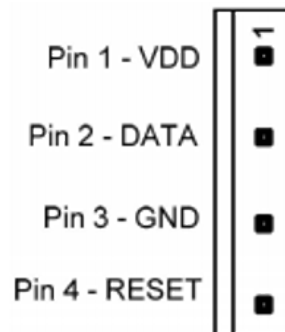
**Figure 26. STVP configuration**


- Step 1.** Power the target off
- Step 2.** Power the target on via a micro-USB cable to supply the board
- Step 3.** Connect ST-LINK circuit to the PC via USB
- Step 4.** Connect the ST-LINK–SWIM cable to the target so that SWIM, RESET, VDD\_STWBC and GND signals are accessible on the STEVAL-ISB045V1T transmitter board test points (refer to the figure below for the wire identification: red for SWIM, yellow for RESET, orange for GND and brown for VDD\_STWBC).

**Figure 27. ST-LINK connection**

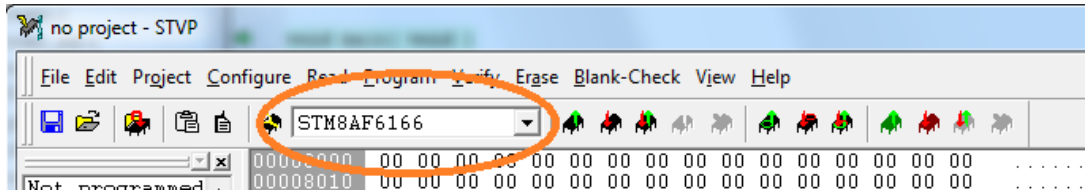

**Figure 28. SWIM connection**

**Table 5. SWIM flat ribbon connections for ST-LINK/V2**

Pin no.	Name	Function	Target connection
1	VDD	Target VCC <sup>(1)</sup>	MCU VCC
2	DATA	SWIM	MCU SWIM pin
3	GND	GROUND	GND
4	RESET	RESET	MCU RESET pin

**Figure 29. Target SWIM connector**


- Step 5.** Launch STVP software
- Step 6.** Select STM8AF6166 core

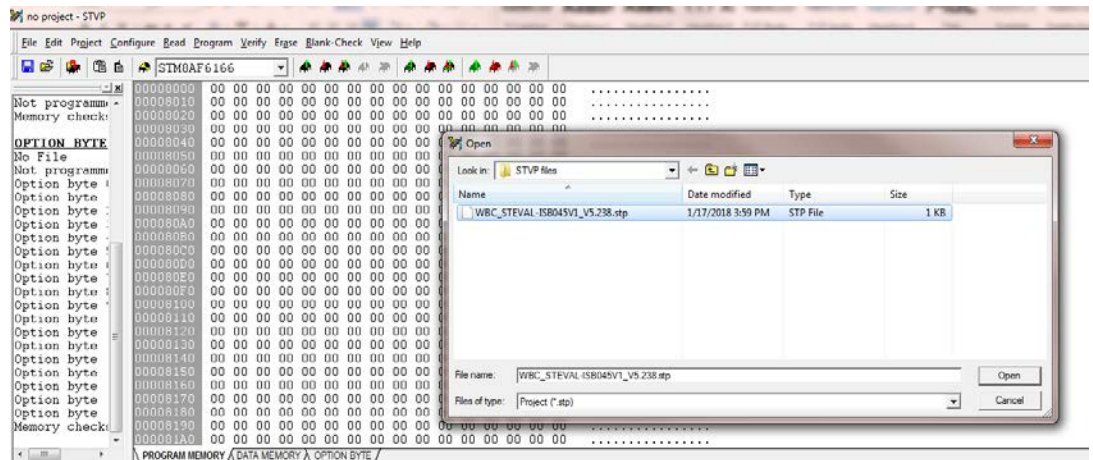
Figure 30. STVP core selection



**Step 7.** In STVP, open the **Project** menu and click **Open**

**Step 8.** Select the .stp given in the zip file

Figure 31. STVP file selection



**Step 9.** Wait a few seconds

The following message should appear:

```

Loading file program.hex in PROGRAM MEMORY area...
< File successfully loaded. File Checksum 0x1D1205
    
```

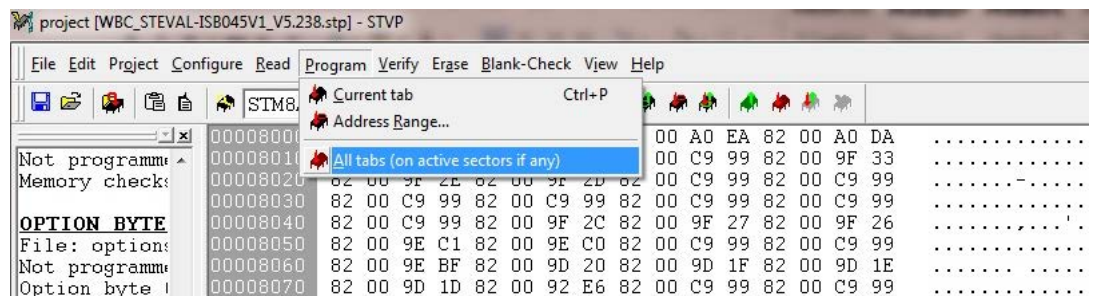
**Note:** It is normal that some warnings appear:

```

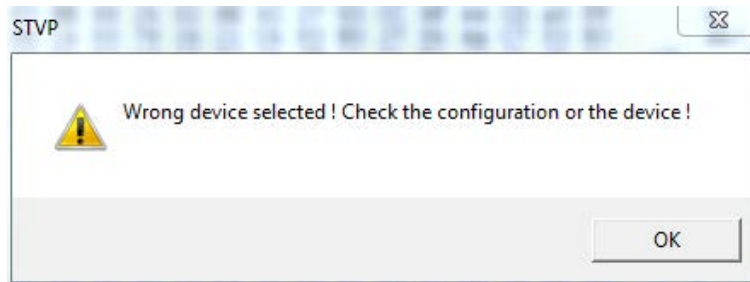
> Loading file options.hex in OPTION BYTE area...
FILE : line 2: Address 0x4802 is out of range and is ignored!
FILE : line 2: Address 0x4804 is out of range and is ignored!
    
```

**Step 10.** In STVP, open the **Program** menu and select **All tabs (on active sectors, if any)**

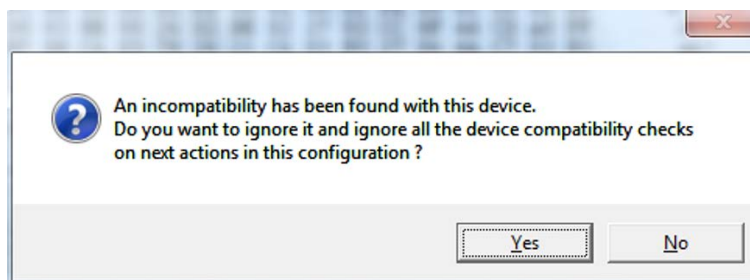
Figure 32. STVP download



**Step 11.** Click OK if the following message appears

**Figure 33. STVP wrong device selected alert**


**Step 12.** Click Yes if the following message appears

**Figure 34. STVP incompatibility device action query**


**Step 13.** After this operation, the programming procedure starts. At completion, the following message appears

```
> Programming PROGRAM MEMORY area...
< PROGRAM MEMORY programming completed.
> Programming ST DATA MEMORY area...
< DATA MEMORY programming completed.
> Programming OPTION BYTE area...
< OPTION BYTE programming completed.
```

**Step 14.** Exit from STVP program

**Step 15.** Disconnect SWIM

**Step 16.** Power the STEVAL-ISB045V1T transmitter board off

*Note:* You can also install the IAR toolchain for firmware compilation and download

### 3.6 Erasing firmware procedure using STVP

This procedure has to be used in case of problems on the board (e.g., firmware corruption, issue during switch from an old firmware version to a new one, etc.).

**Step 1.** Power the target off.

**Step 2.** Power the target on via a micro-USB cable to supply the board.

**Step 3.** Connect ST-LINK circuit to the PC via USB.

**Step 4.** Connect the ST-LINK–SWIM cable to the target so that SWIM, RESET, VDD\_STWBC and GND signals are accessible on the STEVAL-ISB045V1T transmitter board test points (refer to [Figure 27. ST-LINK connection](#) for the wire identification: red for SWIM, yellow for RESET, orange for GND and brown for VDD\_STWBC).

*Note:* The transmitter board has to be unstuck from the plastic case as the test points are accessible on the bottom side (refer to [Figure 28. SWIM connection](#), [Figure 28. SWIM connection](#), [Table 5. SWIM flat ribbon connections for ST-LINK/V2](#) and [Figure 29. Target SWIM connector for details on wired connection](#)).

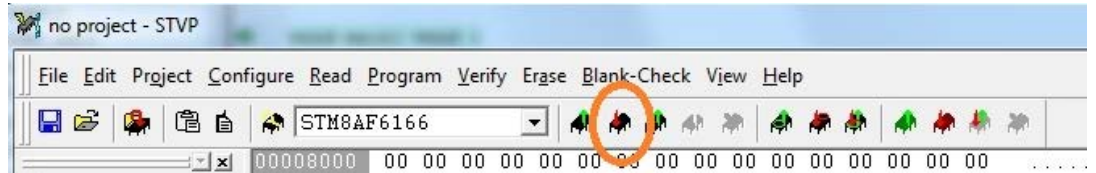
**Step 5.** Launch STVP software.

**Step 6.** Ensure STVP configuration is ok (refer to [Figure 26. STVP configuration](#)).

**Step 7.** Do not load any program in the STVP RAM area as all bits will be erased (load 00 00 00 ...)

- Step 8.** Select STM8AF6166 core (refer to [Figure 30. STVP core selection](#))
- Step 9.** Move the "00 00" to the STWBC-WA through the SWIM interface using the appropriate push button.

**Figure 35. STVP download**



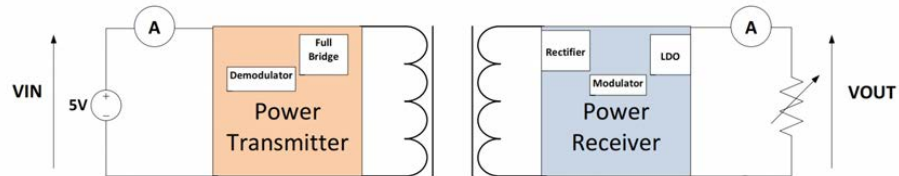
- Step 10.** Click OK if a "wrong device selected" alert appears (refer to [Figure 33. STVP wrong device selected alert](#))
- Step 11.** Click Yes if "An incompatibility has been found with this device" alert appears (refer to [Figure 34. STVP incompatibility device action query](#))
- Step 12.** After this operation, the programming procedure starts. On completion, the following STVP message appears

```
< PROGRAM MEMORY programming completed.
> Verifying PROGRAM MEMORY area...
< PROGRAM MEMORY successfully verified.
```

- Step 13.** Exit from STVP program
- Step 14.** Disconnect SWIM
- Step 15.** Power the STEVAL-ISB045V1T transmitter board off.
- Step 16.** Retry the UART download procedure if necessary.

## 4 Evaluation equipment setup

**Figure 36. STEVAL-ISB045V1 evaluation kit: test setup configuration**



The board is powered via the computer USB connector or via external power supply connection on VCC/GND test points. An electronic load is connected to the receiver output to load up to 2.5 W.

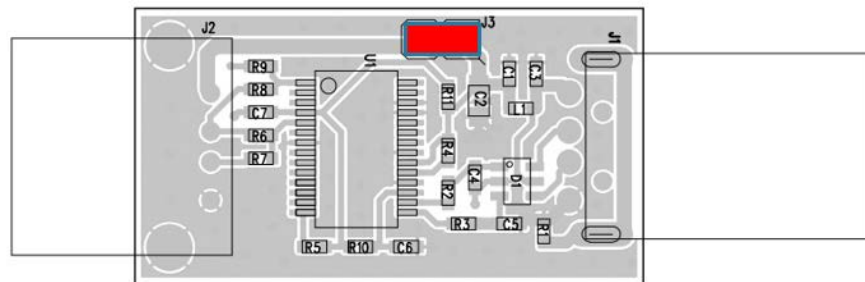
Voltmeters and ammeters measure input and output voltages and currents.

The *STSW-STWBCGUI* is installed on the PC which is connected to the board thanks to STEVAL-WBCDNGV1 dongle.

If the dongle is used to supply the transmitter board, the configuration can be:

1. Computer USB supply (VBUS): ensure a jumper is set on J3 connector

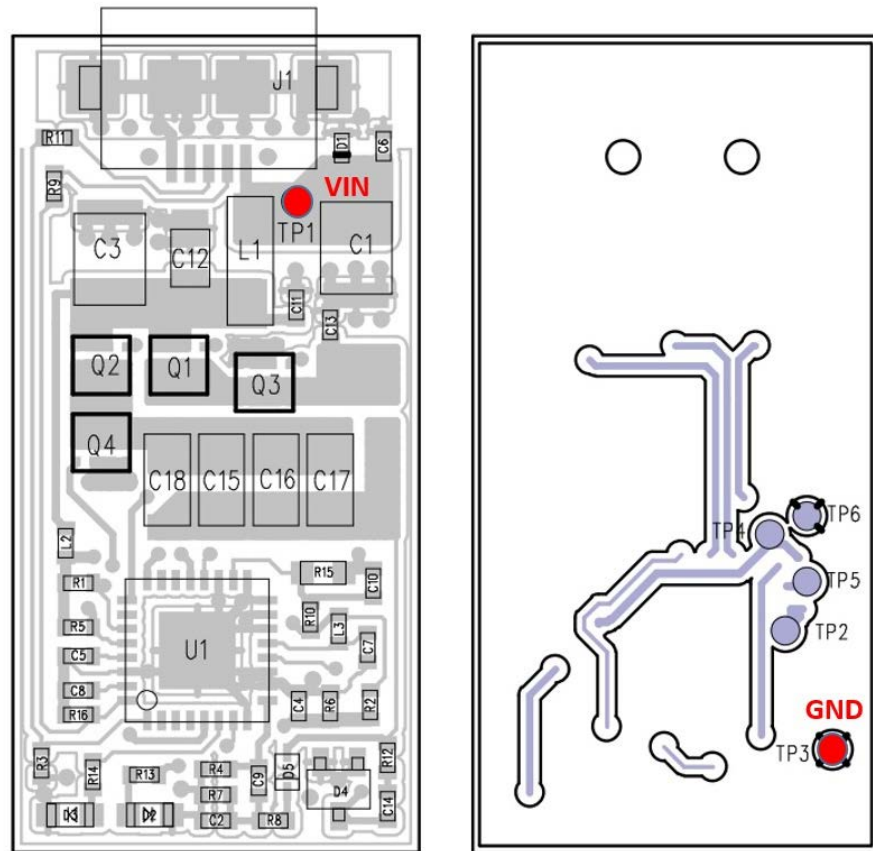
**Figure 37. Power supply via STEVAL-WBCDNGV1 dongle and PC VBUS**



2. External power supply: no jumper has to be set on J3 connector. For instance, 5 V and GND wires can be soldered as shown below.



Figure 38. External power supply



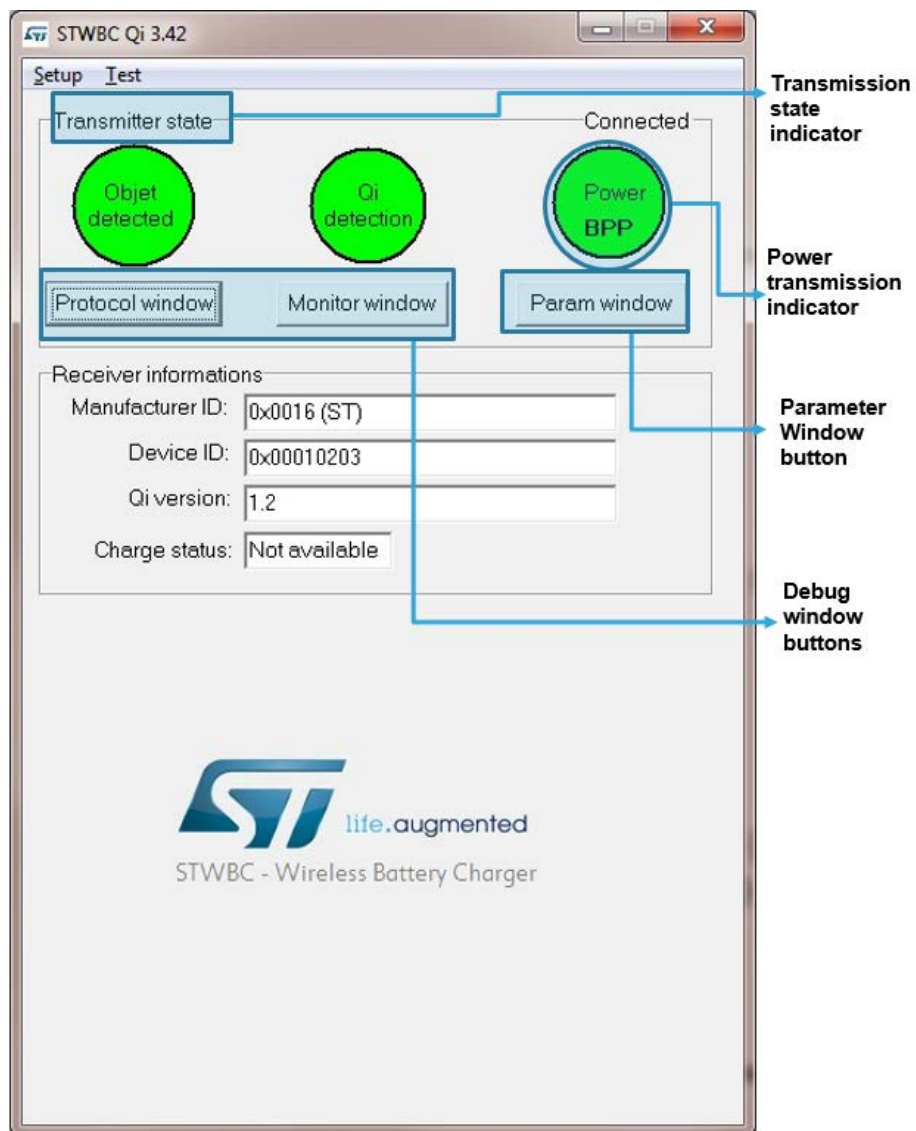
## 5 GUI and evaluation procedure

Refer to [Section 3.1 STSW-STWBCGUI software installation](#) to correctly install STSW-STWBCGUI and connect the STEVAL-ISB045V1 evaluation kit.

The STSW-STWBCGUI thoroughly monitors STWBC-WA operations.

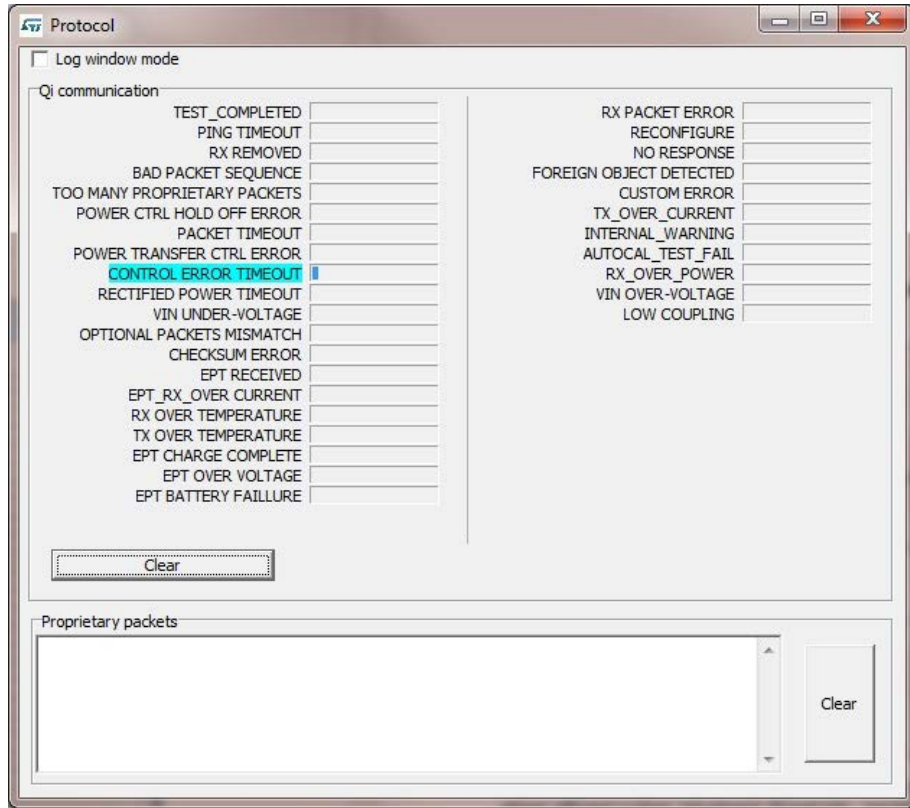
The main screen provides transmitter and Qi receiver status information.

**Figure 39. STSW-STWBCGUI: object detected and charge in progress**



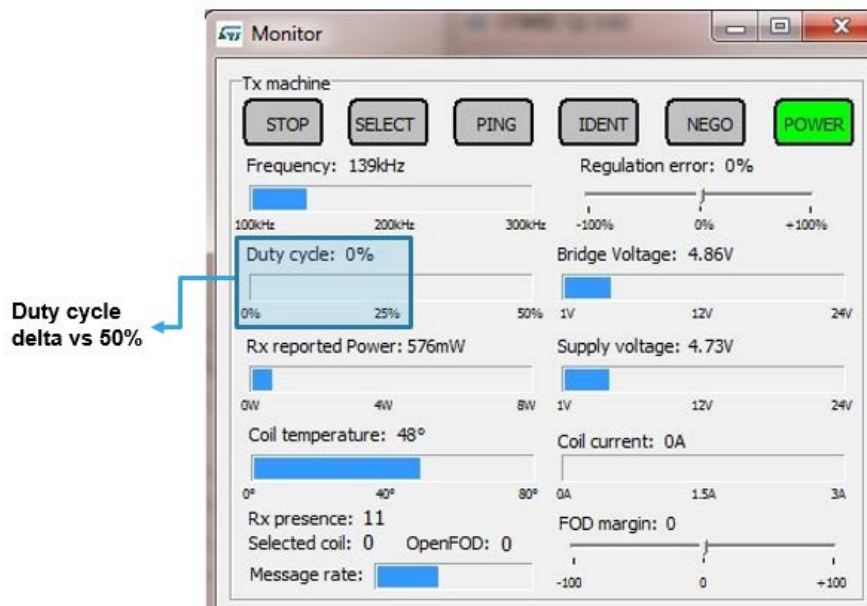
The STSW-STWBCGUI can also display the Rx to Tx communication protocol errors, useful for system debugging.

Figure 40. STSW-STWBCGUI: Qi protocol window



You can also monitor STWBC-WA internal variables such as bridge voltage and frequency, Rx reported power, coil temperature, etc.

Figure 41. STSW-STWBCGUI: monitor window

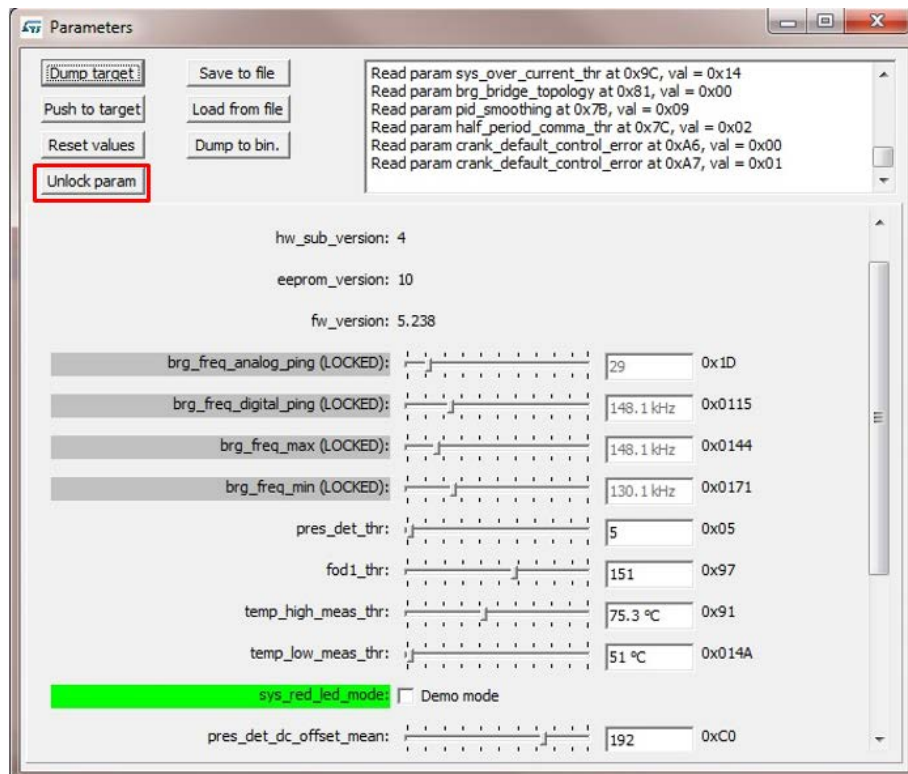


The GUI user-friendly interface allows efficient system adjustment (thresholds, regulation error) and lets you store parameters to and load parameters from your computer.

The parameters have the following levels of protection:

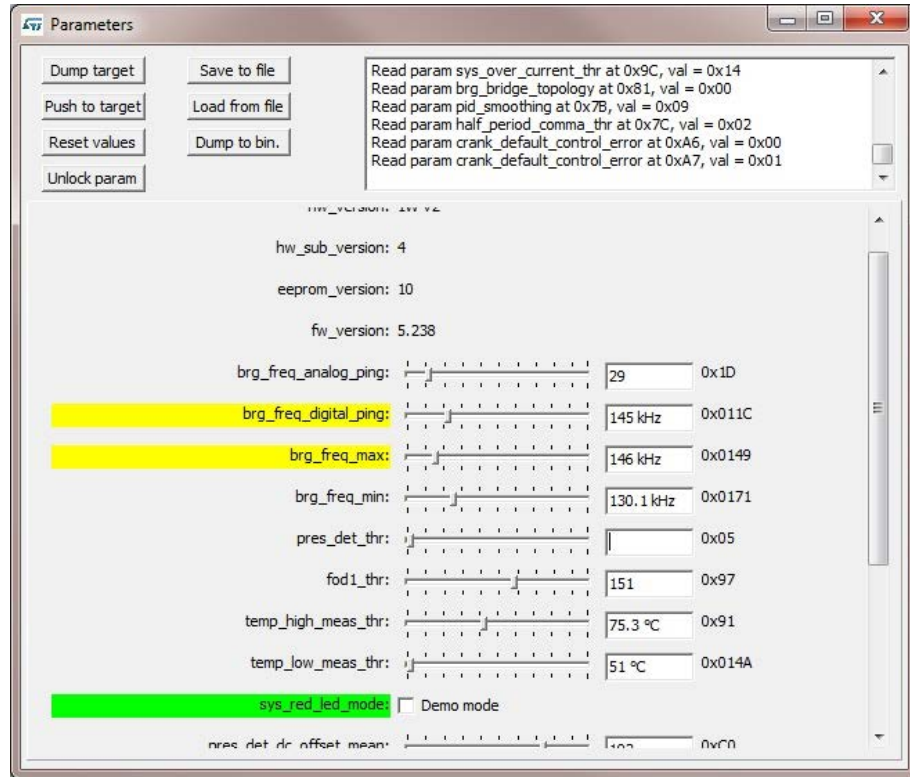
- Level 0: parameters can be modified without protection
- Level 1: more critical parameters to be modified with caution. You must click the **Unlock param** button before modifying it, with caution, as it can lead to system malfunction or trigger unexpected behavior.

Figure 42. STSW-STWBCGUI: parameter window



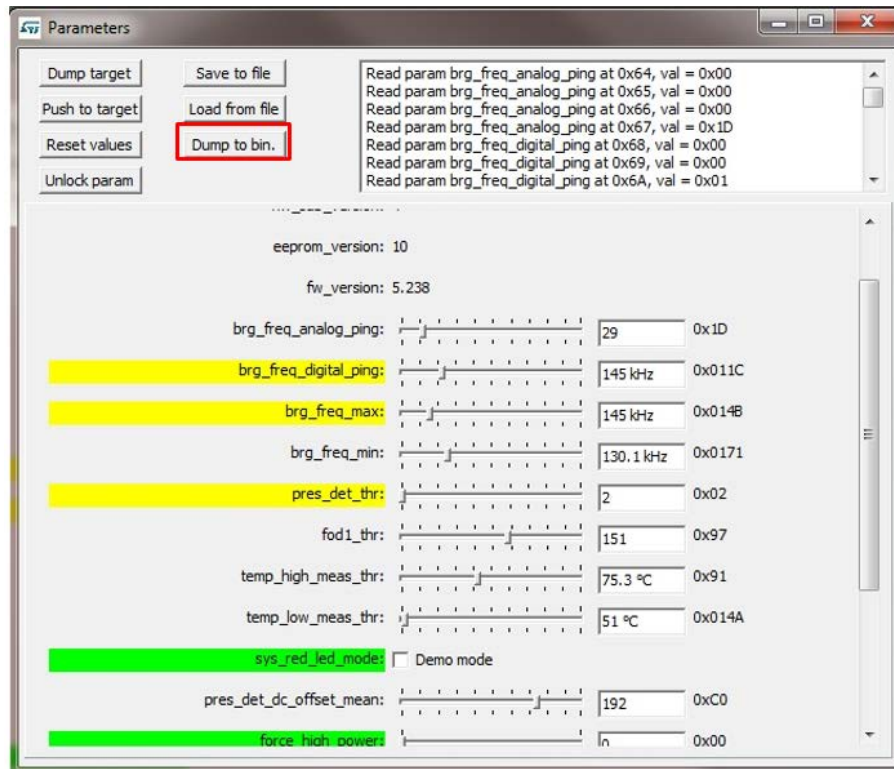
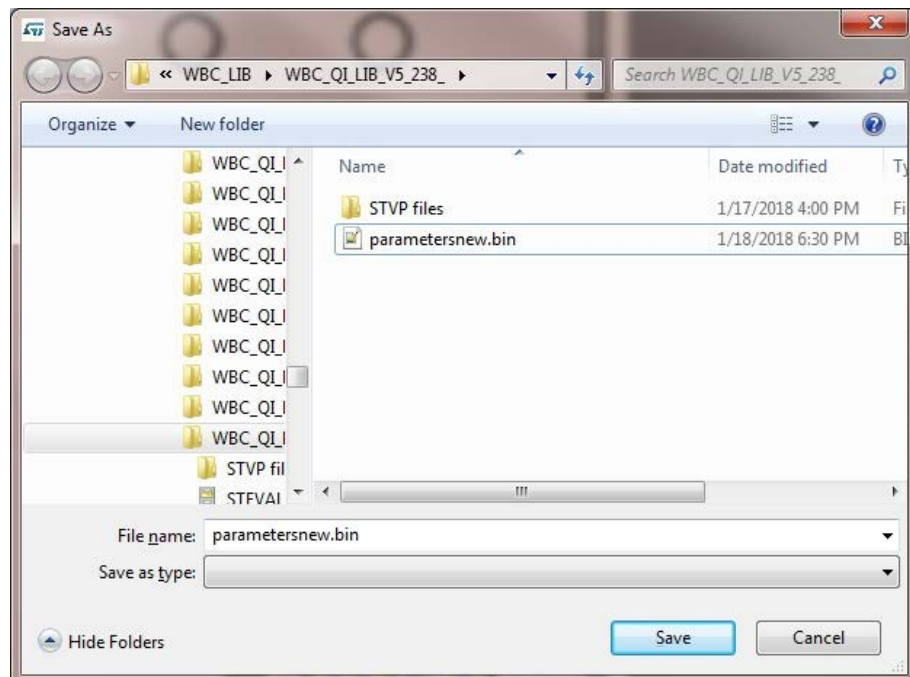
Parameters can be modified and their effect can be tested immediately by clicking **Push to target**; you can double check the parameter modification by clicking on **Dump target** button.

Figure 43. STSW-STWBCGUI: parameter modification



The GUI embeds the [STSW-STWBCFWD](#) downloader interface (which uses UART connection) and includes tools to generate binary files with adjusted parameters and to build new firmware packages incorporating these files.

Through the GUI, you can change the parameters and produce a new cab to program a batch of new boards. To do so, dump the parameters into a bin file, but only after clicking the **Push to target** button.

**Figure 44. STSW-STWBCGUI: saving modified parameters (Dump to bin)**

**Figure 45. STSW-STWBCGUI: bin file backup**


You can then select **Modify parameters in CAB file** from the setup menu and select the appropriate firmware CAB file to be patched. This operation will alter the firmware file with new tuning parameters, which can be subsequently loaded using the standard procedure.

Figure 46. STSW-STWBCGUI: CAB file patch button



## 5.1 Status LEDs

The status LEDs give the state of the charge:

### At startup

- Red short blinking: when the board auto-calibration is on-going. You have to wait for the LED to be switched off before putting a receiver on the surface.
- Red and green blinking once: an internal reset occurred.
- Red and green steady state: firmware/STWBC chip mismatch

- Red steady and after 2 seconds green steady state: board hardware subversion detected does not match the firmware

**In steady state**

- Green blinking: power transfer in progress
- Green steady state: the charge is complete
- Red blinking: an error has been detected, as incomplete charge due to battery fault, overvoltage, overcurrent, etc.
- Red steady state: the transmitter is stuck until the receiver is removed, as mentioned in the Qi standard (power transfer stopped three times in a row due to the amount of power not provided to the receiver, some types of end power transfer or no response error code)

## 5.2 Presence detection calibration procedure

This auto-calibration is necessary in the [STSW-STWBCGUI](#) for the presence detection algorithm and is mandatory to ensure a correct functioning of the STEVAL-ISB045V1T transmitter board.

*Important:* This calibration is mandatory after each new firmware download.

- Step 1.** Start the calibration only once after a new firmware download, without placing the receiver on the transmitter



Figure 47. STSW-STWBCGUI auto-calibration start

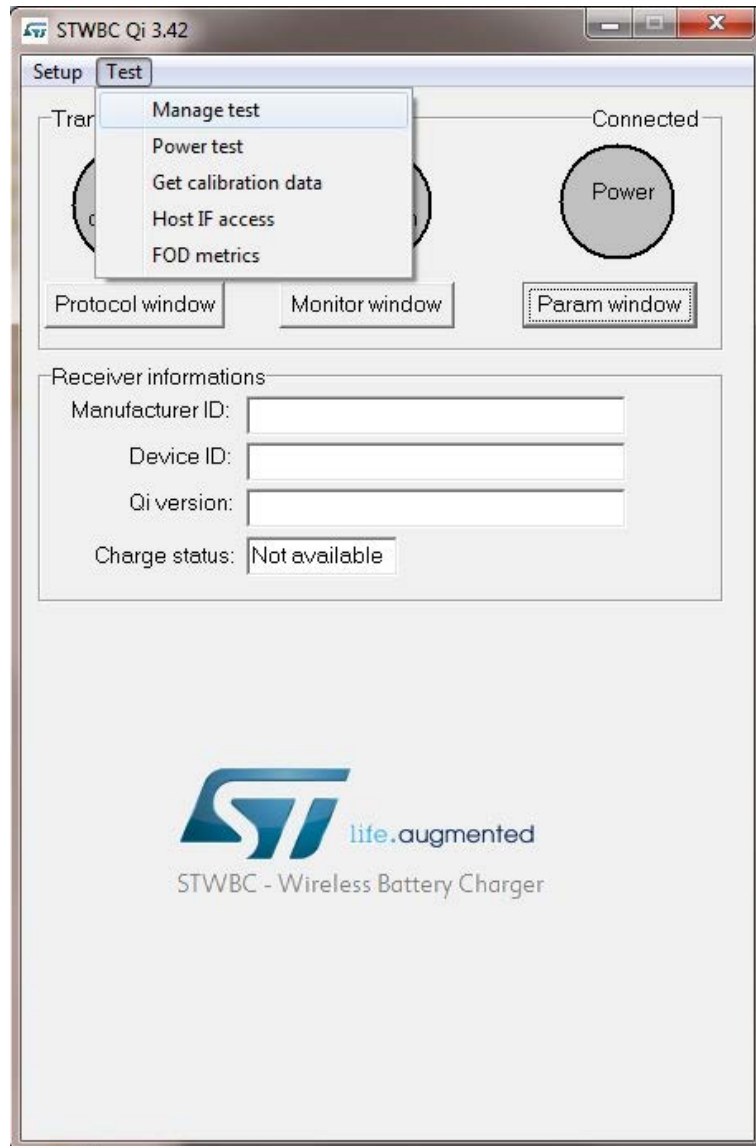


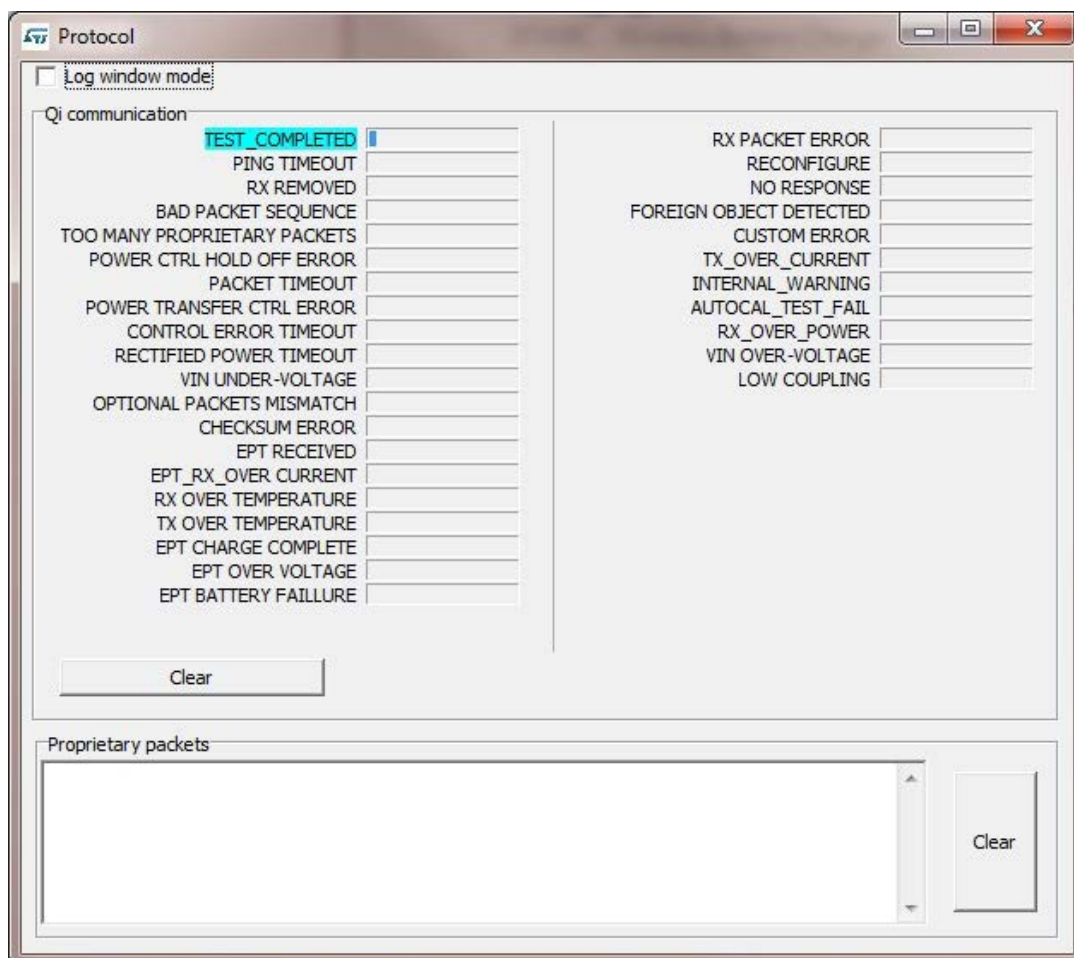
Figure 48. STSW-STWBCGUI presence detection test



Once the calibration is done, a status bit is set in the chip.

- Step 2.** Use the protocol window to check if **test completed** has been set (which means the calibration was successful).

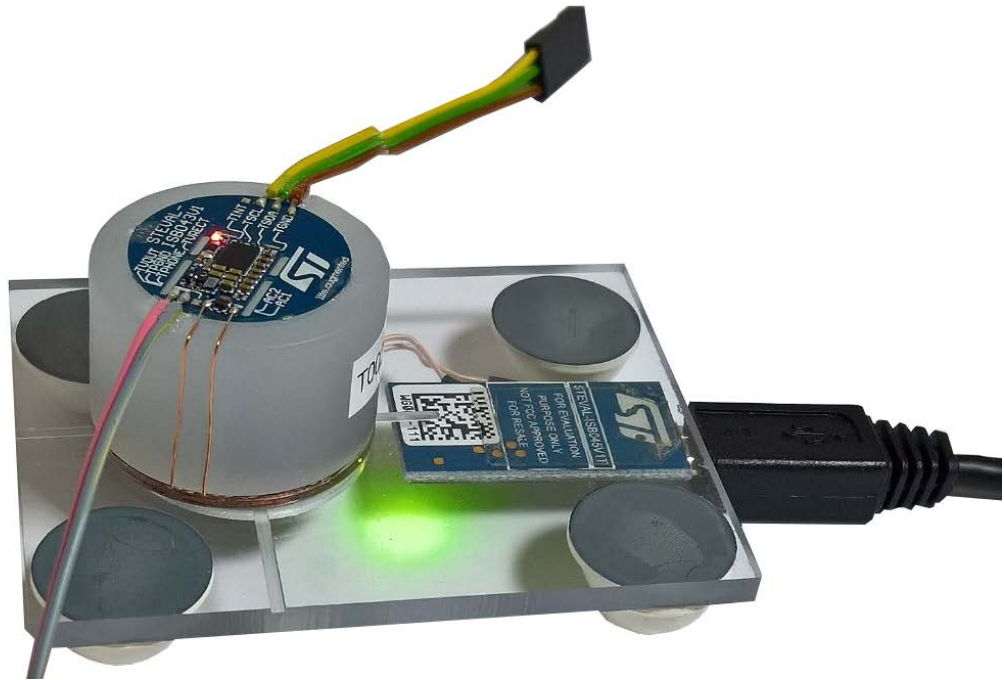
Figure 49. STSW-STWBCGUI presence detection calibration check



### 5.3 Efficiency

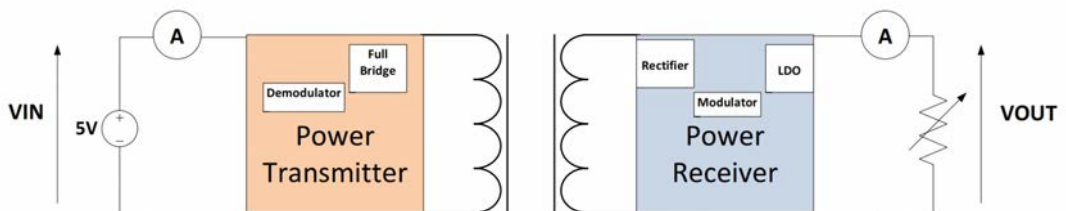
Efficiency measurements are performed connecting the STEVAL-ISB045V1T transmitter board with the 2.5 W STEVAL-ISB043V1 receiver.

Figure 50. STEVAL-ISB045V1T test setup

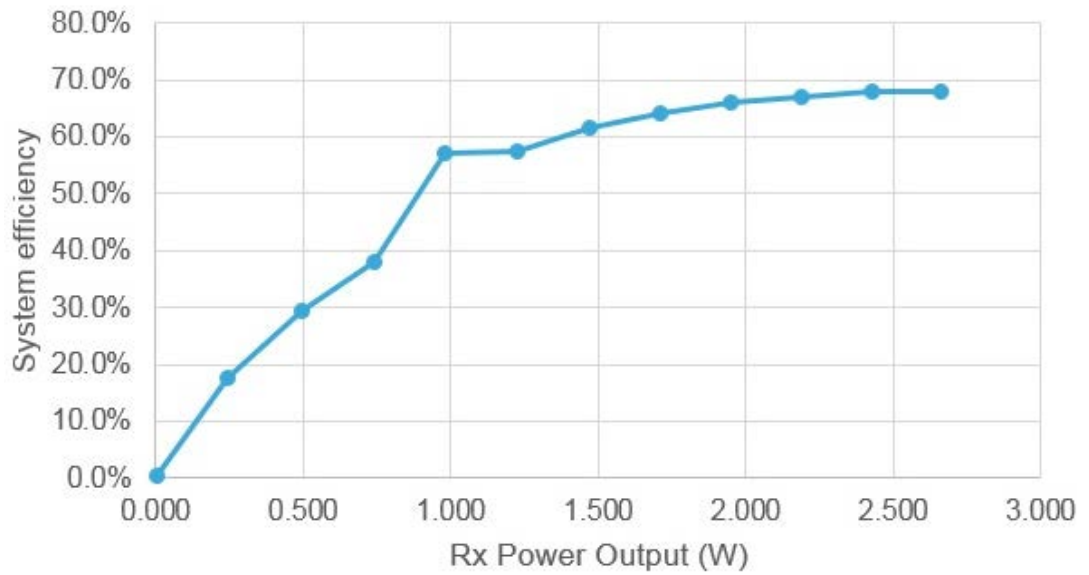


The STEVAL-ISB045V1T transmitter board is supplied by 5 V/1 A and the receiver voltage level is 5 V.  $P_{OUT}$  is the output power actually measured at the receiver output (not only at the rectifier output) and  $P_{IN}$  is the input power.

Figure 51. Efficiency setup



The figure below shows the typical performance of the kit coils (efficiency= $P_{OUT}/P_{IN}$ ).

**Figure 52. STEVAL-ISB045V1 evaluation board: efficiency vs output power**


#### 5.4 Standby consumption

In standby, when the board is supplied at 5 V, very low power consumption is achieved.

In this mode, device detection is still ensured; power consumption is reduced down to 320  $\mu$ A average, thus a low standby power of only 1.6 mW.

*Note:* To measure this low power consumption, the UART cable must be unplugged.

## 6 STEVAL-ISB045V1 schematic diagrams

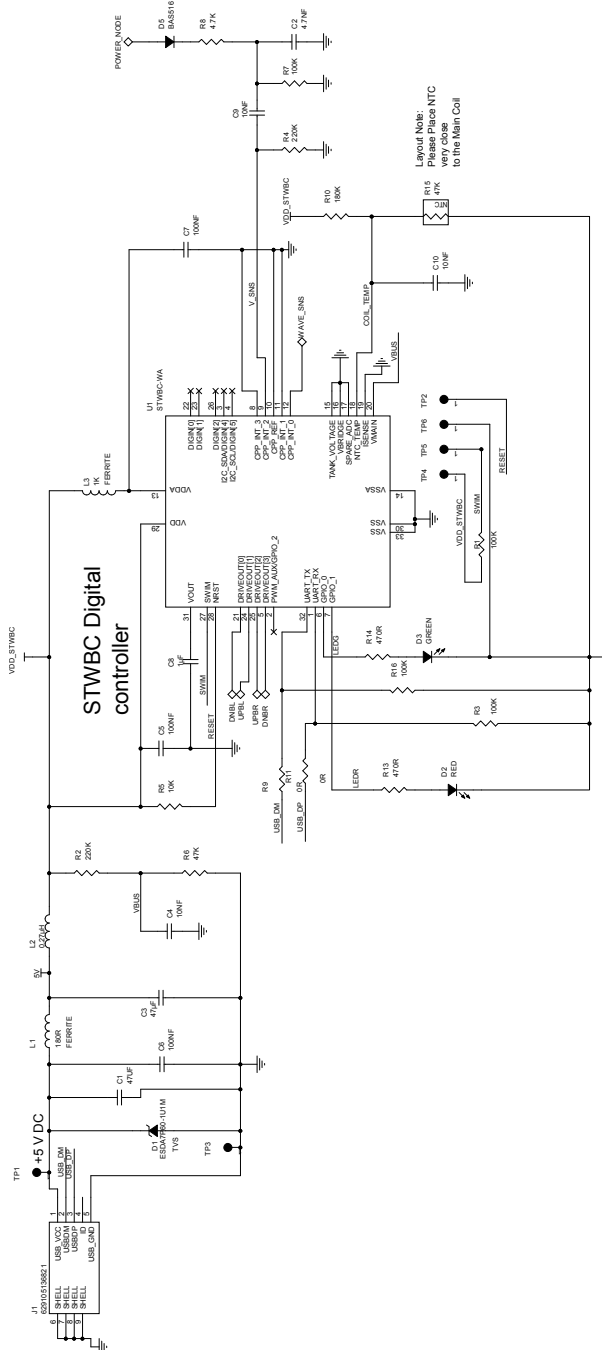
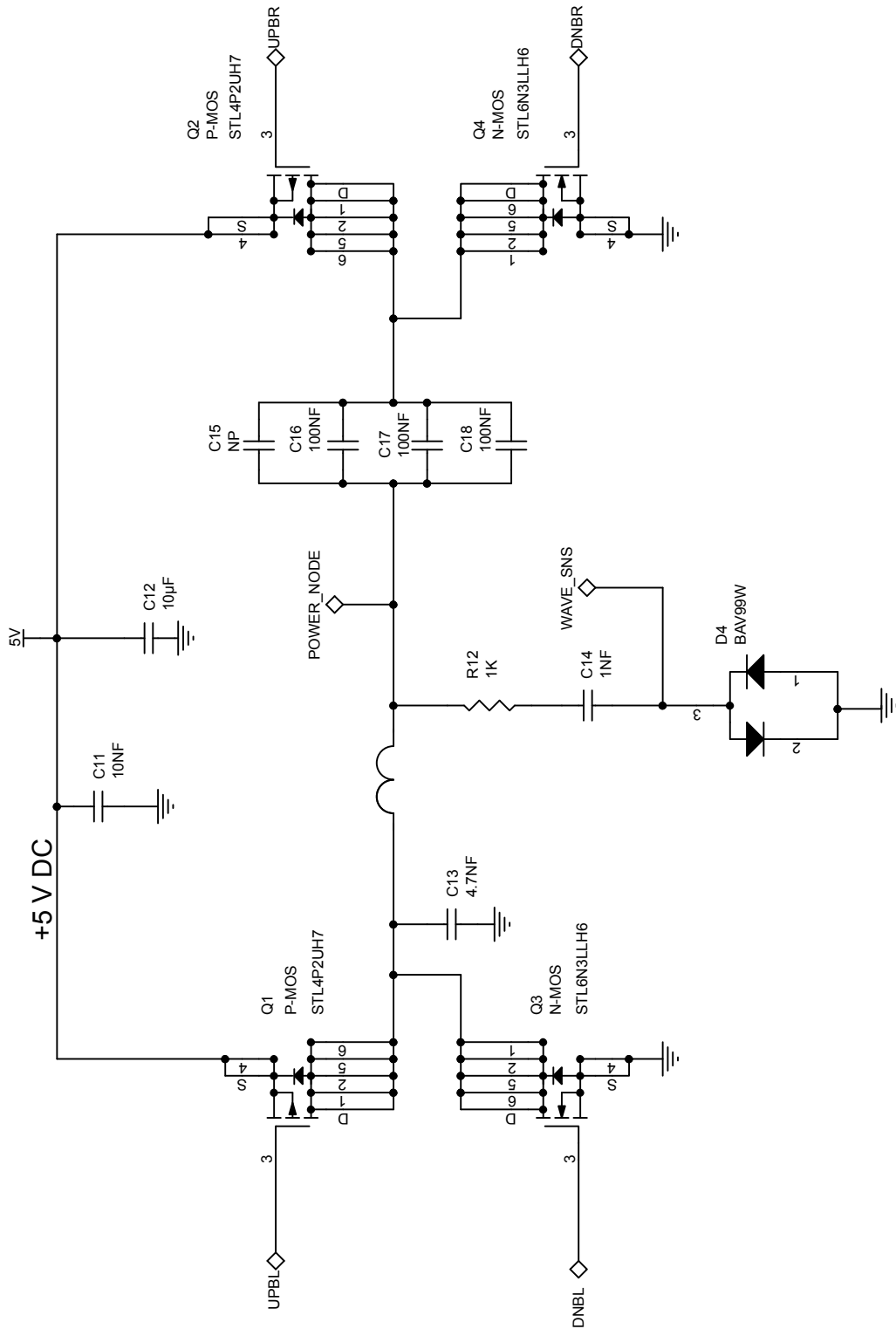
**Figure 53. STEVAL-ISB045V1T circuit schematic (1 of 3)**


Figure 54. STEVAL-ISB045V1T circuit schematic (2 of 3)



Layout note : GND plan dedicated to the bridge and the power supply connector

Figure 55. STEVAL-ISB045V1T circuit schematic (3 of 3)

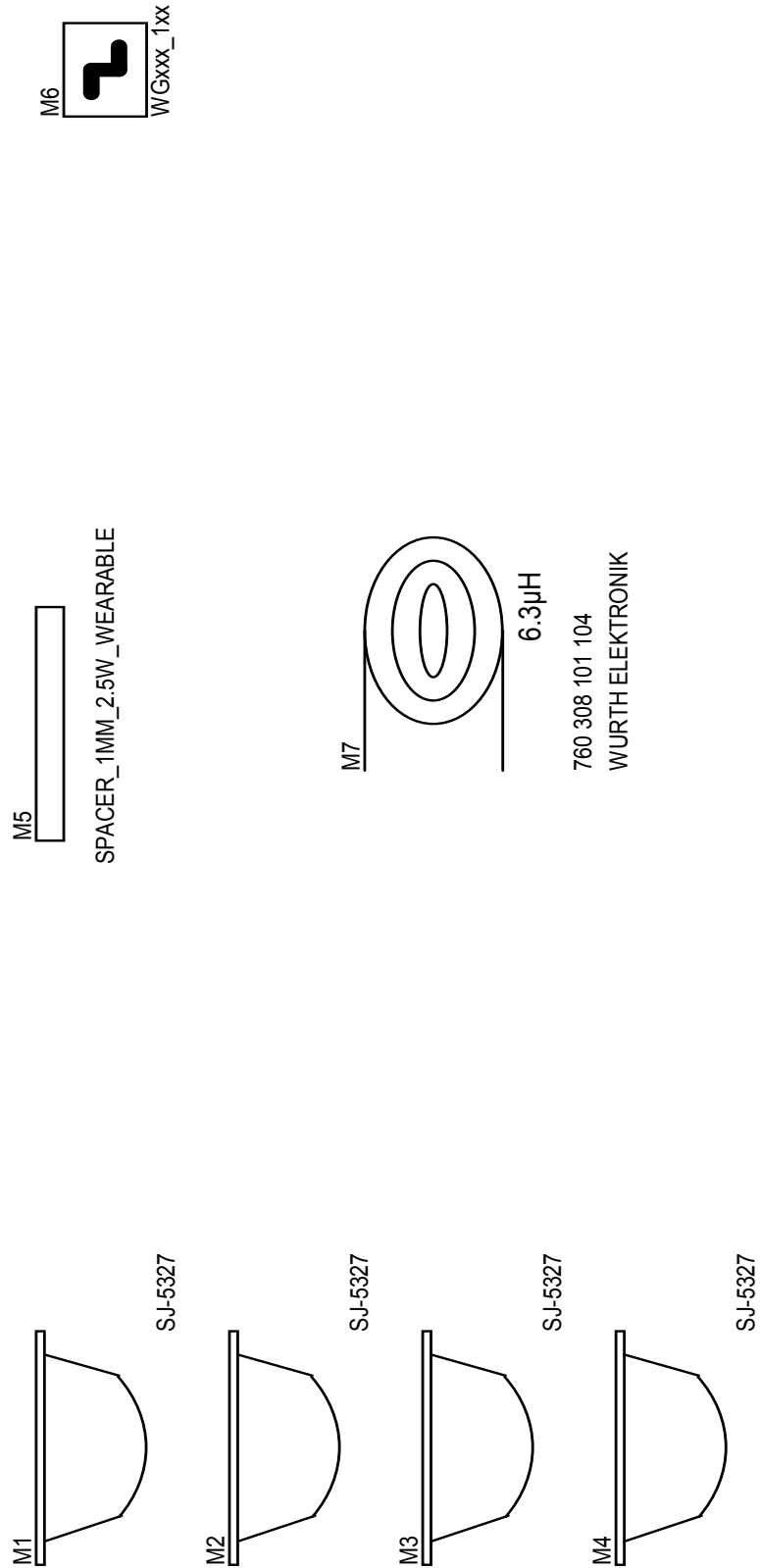
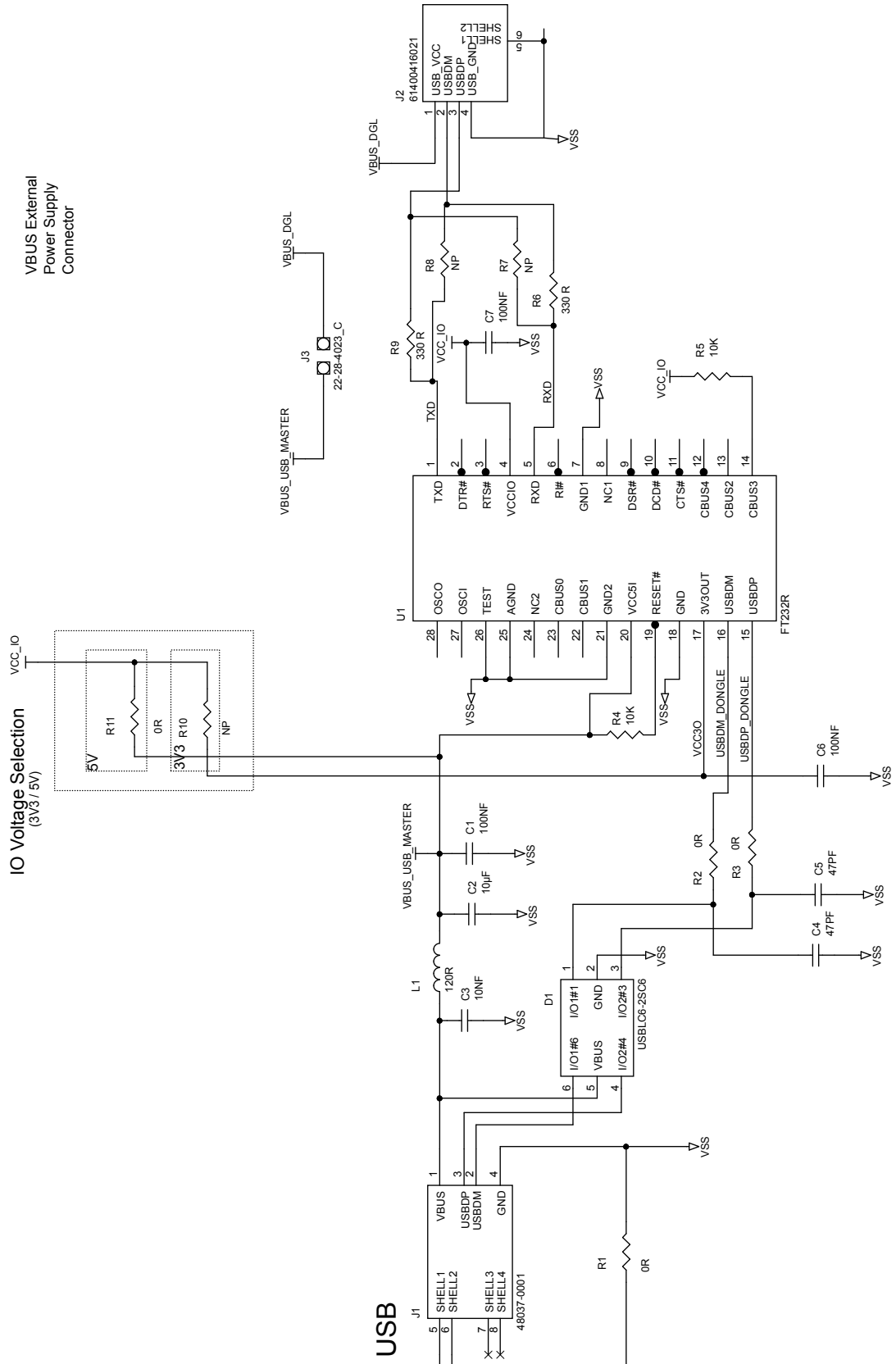




Figure 56. STEVAL-WBCDNGV1 circuit schematic



## 7 Bill of materials

**Table 6. STEVAL-ISB045V1T bill of materials**

Item	Q.ty	Ref.	Part/Value	Description	Manufacturer	Order code
1	2	C1, C3	47 $\mu$ F 16 V $\pm$ 20% 1210	Ceramic capacitors	Murata	GRM32ER61C476ME15
2	2	C2, C13	4.7 NF 50 V $\pm$ 15% 402	Ceramic capacitors	Any	4.7NF_50V_X7R_0402
3	4	C4, C9, C10, C11	10 NF 50 V $\pm$ 15% 402	Ceramic capacitors	Any	10NF_50V_X7R_0402
4	3	C5, C6, C7	100 NF 50 V $\pm$ 15% 402	Ceramic capacitors	Any	100NF_50V_X5R_0402
5	1	C8	1 $\mu$ F 16 V $\pm$ 1% 402	Ceramic capacitor	Any	1UF_16V_X5R_0402
6	1	C12	10 $\mu$ F 10 V $\pm$ 1% 805	Ceramic capacitor	Murata	GRM21BR71A106KE51L
7	1	C14	1 NF 50 V $\pm$ 15% 402	Ceramic capacitor	Any	1NF_50V_X5R_0402
8	1	C15	NP 1206	Ceramic capacitor	Any	C_NP_1206
9	3	C16, C17, C18	100 NF 50 V $\pm$ 5% 1206	Ceramic capacitors	Murata	GRM31C5C1H104JA01L
10	1	D1	ESDA7P60-1U1M L1.55_W0.95_H0.53	High-power transient voltage suppressor (TVS)	ST	<a href="#">ESDA7P60-1U1M</a>
11	1	D2	RED 603	LED	Würth Elektronik	150060RS75000
12	1	D3	GREEN 603	LED	Würth Elektronik	150060VS75000
13	1	D4	BAV99W SOT323	Diode	NXP	BAV99W
14	1	D5	BAS516 DIOD_SOD523	Diode	Any	BAS516
15	1	J1	629105136821	USB	Würth Elektronik	629105136821
16	1	L1	180R 3 A $\pm$ 25% 1806	Ferrite	Murata	BLM41PG181SN1
17	1	L2	0.27 $\mu$ H 0.11 A $\pm$ 5% 402	Inductor	Taiyo Yuden	HK1005R27J-T
18	1	L3	1 K 0.2 A $\pm$ 25% 402	Ferrite	Murata	BLM15AG102SN1D
19	4	M1, M2, M3, M4	SJ-5327 transparent	Spacer	3M	SJ-5327 (Transparent)
20	1	M5	SPACER_1MM_2.5W_WEARABLE	Spacer	Any	SPACER_1MM_2.5W_WEARABLE
21	1	M6	WGxxx_1xx	PCB	Any	PCB WG - 2 layers
22	1	M7	6.3 $\mu$ H 2.5 A D55	Inductor	Würth Elektronik	760 308 101 104
23	2	Q1, Q2	P-MOS L2_W2_H0.75	P-channel Power MOSFET	ST	<a href="#">STL4P2UH7</a>

Item	Q.ty	Ref.	Part/Value	Description	Manufacturer	Order code
24	2	Q3, Q4	N-MOS L2_W2_H0.75	N-channel 30 V, 0.021 Ohm typ., 6 A STripFET H6 Power MOSFET	ST	<a href="#">STL6N3LLH6</a>
25	4	R1, R3, R7, R16	100 K 1/16 W ±5% 402	Resistors	Any	100K_5%_0402
26	1	R2	220 K 1/16 W ±1% 402	Resistor	Any	220K_1%_0402
27	1	R4	220 K 1/16 W ±5% 402	Resistor	Any	220K_5%_0402
28	1	R5	10 K 1/16 W ±5% 402	Resistor	Any	10K_5%_0402
29	1	R6	47 K 1/16 W ±1% 402	Resistor	Any	47K_1%_0402
30	1	R8	4.7 K 1/16 W ±5% 402	Resistor	Any	4.7K_5%_0402
31	2	R9, R11	0 R 1/16 W ±5% 402	Resistors	Any	0R_5%_0402
32	1	R10	180 K 1/16 W ±5% 402	Resistor	Any	180K_5%_0402
33	1	R12	1 K 1/16 W ±5% 402	Resistor	Any	1K_5%_0402
34	2	R13, R14	470 R 1/16 W ±5% 402	Resistors	Any	470R_5%_0402
35	1	R15	47 K 1/10 W ±5% 603	Resistor	Murata	NCP18WB473J03RB
36	6	TP1, TP2, TP3, TP4, TP5, TP6	TPSMD-1MM Test Point	Test point	Any	TPSMD-1MM
37	1	U1	STWBC-WA QFN32	Digital controller for wireless battery charger transmitters for wearable and smart watches applications	ST	<a href="#">STWBC-WA</a>

**Table 7. STEVAL-WBCDNGV1 bill of materials**

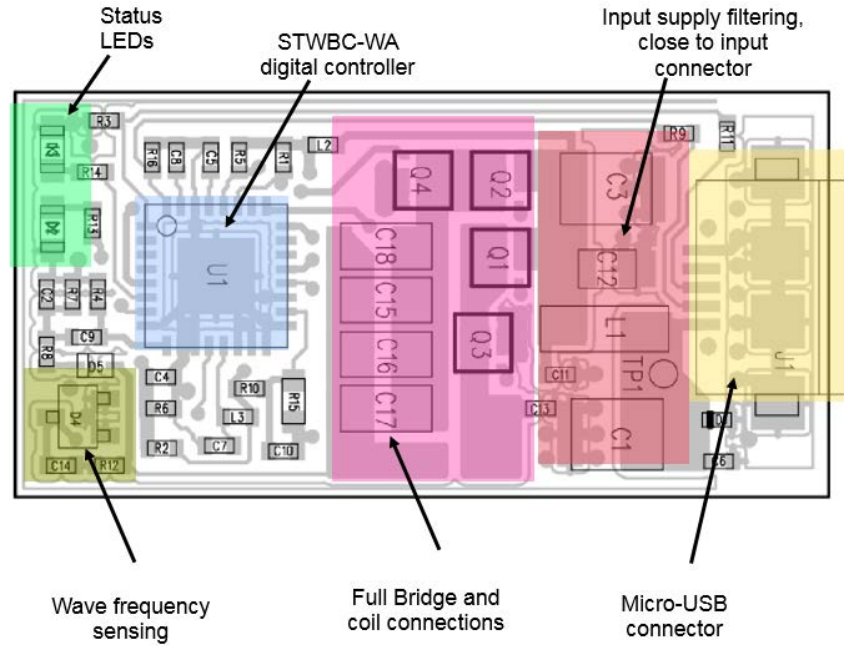
Item	Q.ty	Ref.	Part/Value	Description	Manufacturer	Order code
1	3	C1, C6, C7	100 NF 50 V ±15% 603	Ceramic capacitors	Any	100NF_50V_X7R_0603
2	1	C2	10 µF 25 V ±10% 805	Ceramic capacitor	Any	10UF_25V_X7R_0805
3	1	C3	10 NF 50 V ±15% 603	Ceramic capacitor	Any	10NF_50V_X7R_0603
4	2	C4, C5	47 PF 25 V 0.15 603	Ceramic capacitors	Any	47PF_25V_X5R_0603
5	1	D1	USBLC6-2SC6 SOT23-6L	Very low capacitance ESD protection	ST	<a href="#">USBLC6-2SC6</a>
6	1	J1	48037-0001	USB	Molex	48037-0001
7	1	J2	61400416021	USB	Würth Elektronik	61400416021
8	1	J3	22-28-4023_C JUMP254P-M-2	Header	Molex	22-28-4023_C
9	1	L1	120 R 0.5 A ±25% 603	Ferrite	Würth Elektronik	74279262

Item	Q.ty	Ref.	Part/Value	Description	Manufacturer	Order code
10	4	R1, R2, R3, R11	0 R 1/10 W ±5% 603	Resistors	Any	0R_5%_0603
11	2	R4, R5	10 K 1/10 W ±5% 603	Resistors	Any	10K_5%_0603
12	2	R6, R9	330 R 1/10 W ±5% 603	Resistors	Any	330R_5%_0603
13	3	R7, R8, R10	NP 603	Resistors	Any	R_NP_0603
14	1	U1	FT232R SSOP28	Converter	FTDI	FT232R

## 8 STEVAL-ISB045V1T transmitter board assembly and layout

The evaluation board has been designed using a low cost 2-layer PCB with all the components on the same side. The UART is accessible through a micro-USB connector and SWIM signals are accessible on the test points.

**Figure 57. STEVAL-ISB045V1T transmitter main blocks**



To ensure correct functioning, you have to follow some design rules for the board assembly.

As the current flowing in the board can be large, many vias must be used to route the 5 V and the power GND from top to bottom.

Large track or plane should be used for power GND, 5 V supply voltage and LC power node.

Figure 58. STEVAL-ISB045V1T transmitter:  $V_{IN}$  and 5 V power signal routing

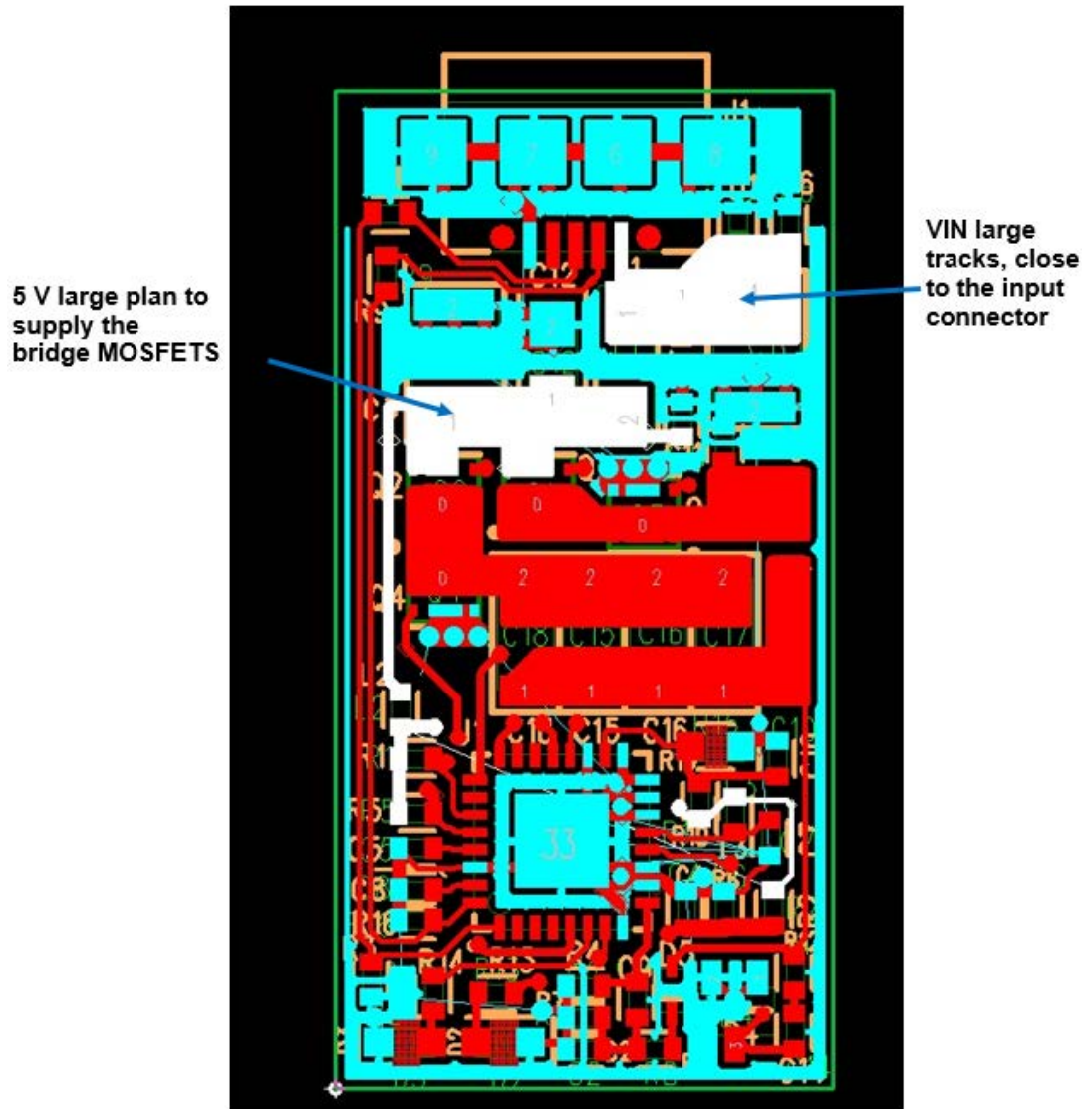


Figure 59. STEVAL-ISB045V1T transmitter: voltage supply for bridge MOSFETs (zoom)

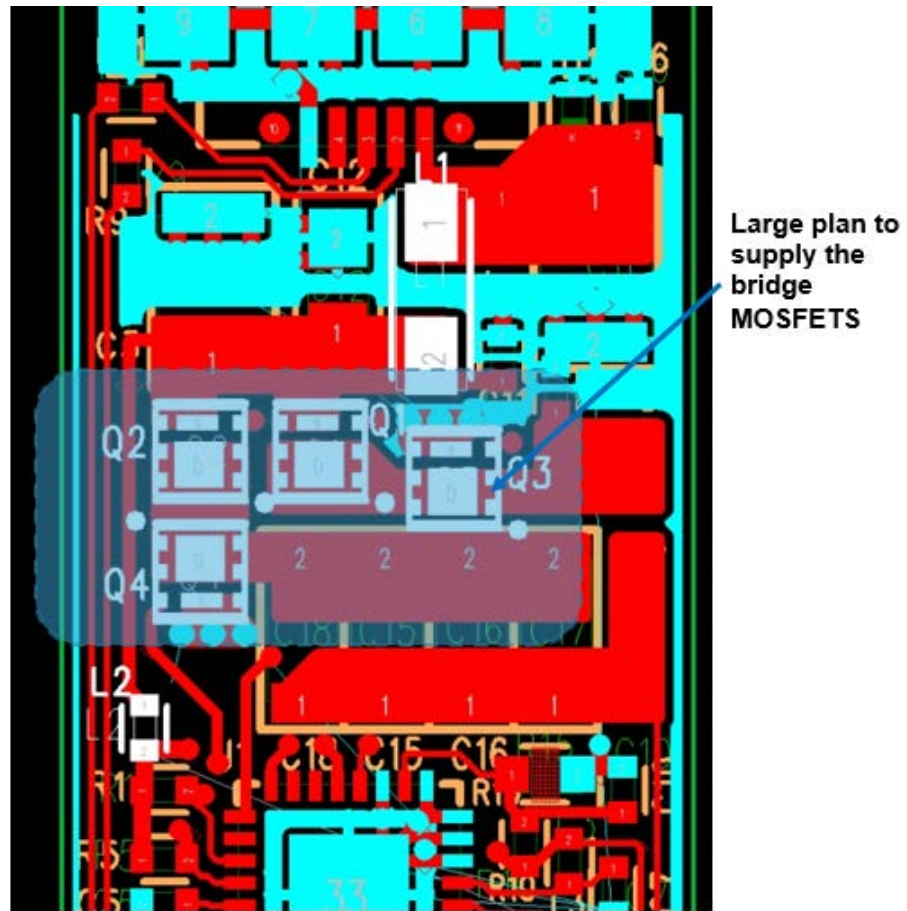
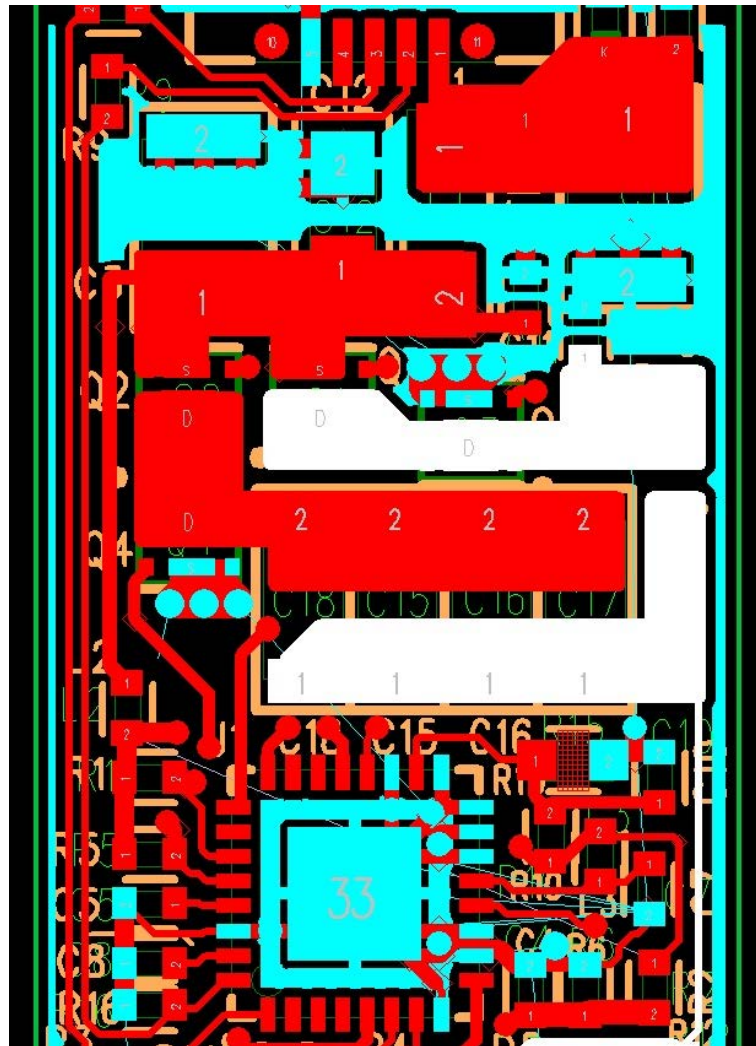


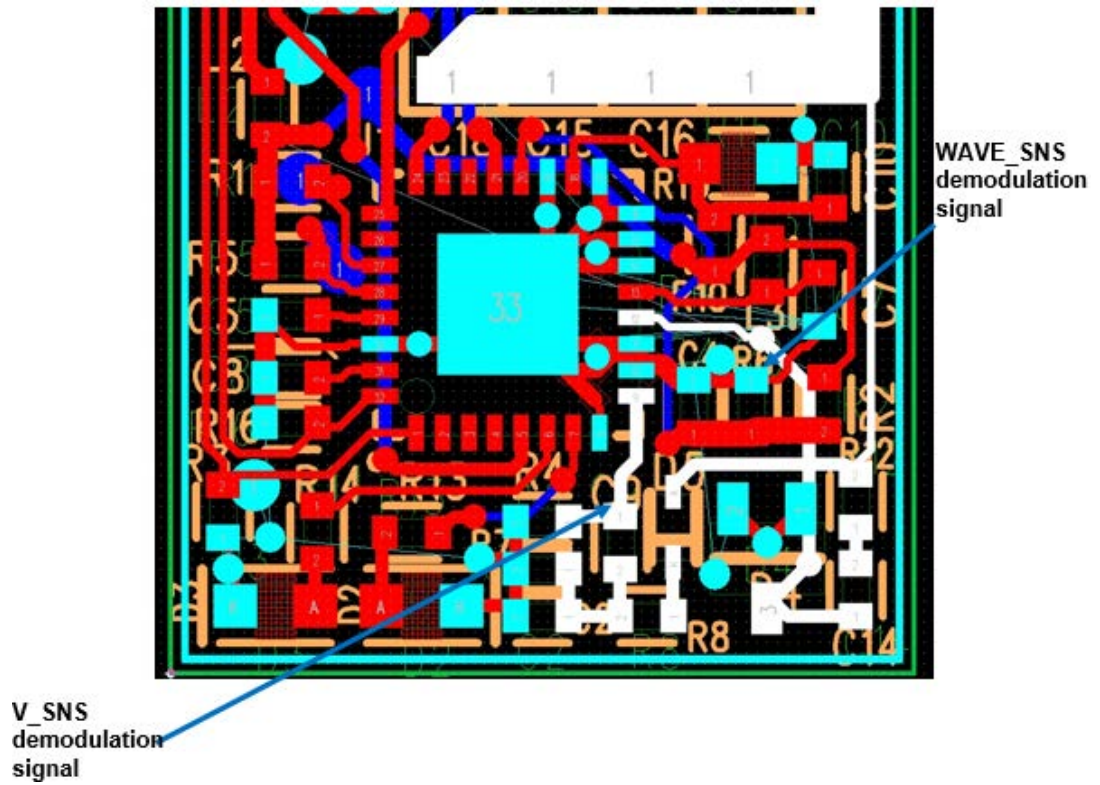
Figure 60. STEVAL-ISB045V1T transmitter: large tracks for wireless power coil connection



The layout must also be clean on the demodulation signals ( $V_{SNS}$ ,  $WAVE_{SNS}$ ) to avoid any coupling with the switching of the power bridge (Power\_node and UPBL/DNBL/UPBR, DNBR signals).



Figure 61. STEVAL-ISB045V1T transmitter: large tracks for wireless power coil connection (zoom)



## A References

Freely available at [www.st.com](http://www.st.com):

1. Datasheet (DS11797): STWBC-WA – Digital controller for wireless battery charger transmitters for wearable and smartwatch applications.
2. Databrief (DB3531): STEVAL-ISB045V1 - 2.5 W wireless charger transmitter evaluation kit
3. User manual (UM2368): STWBC 2.5 W turnkey firmware description
4. Databrief (DB3410): STSW-STWBCFWDT - STWBC firmware downloader tool

## Revision history

**Table 8. Document revision history**

Date	Version	Changes
13-Mar-2018	1	Initial release.
14-May-2018	2	Updated <a href="#">Section 5.4 Standby consumption</a> .

## Contents

<b>1</b>	<b>Getting started</b> .....	<b>2</b>
1.1	System requirements .....	2
1.2	Package contents .....	2
<b>2</b>	<b>Hardware description and setup</b> .....	<b>3</b>
2.1	System block diagram .....	3
2.2	STEVAL-ISB045V1 wireless transmitter kit overview .....	3
2.3	STWBC-WA pinout and pin description .....	7
<b>3</b>	<b>Download procedure</b> .....	<b>10</b>
3.1	STSW-STWBCGUI software installation .....	10
3.2	Firmware download via STSW-STWBCGUI .....	11
3.2.1	Download procedure with a new chip (never been programmed) .....	11
3.2.2	Firmware upgrade procedure (chip already programmed) .....	14
3.3	Firmware download with command line (UART) .....	15
3.3.1	Firmware download with written chip .....	15
3.3.2	Firmware download with blank chip .....	15
3.4	STVP file creation .....	16
3.5	Firmware download with STVP .....	18
3.6	Erasing firmware procedure using STVP .....	22
<b>4</b>	<b>Evaluation equipment setup</b> .....	<b>24</b>
<b>5</b>	<b>GUI and evaluation procedure</b> .....	<b>26</b>
5.1	Status LEDs .....	31
5.2	Presence detection calibration procedure .....	32
5.3	Efficiency .....	35
5.4	Standby consumption .....	37
<b>6</b>	<b>STEVAL-ISB045V1 schematic diagrams</b> .....	<b>38</b>
<b>7</b>	<b>Bill of materials</b> .....	<b>42</b>
<b>8</b>	<b>STEVAL-ISB045V1T transmitter board assembly and layout</b> .....	<b>45</b>
<b>A</b>	<b>References</b> .....	<b>50</b>
	<b>Revision history</b> .....	<b>51</b>

## List of tables

<b>Table 1.</b>	STEVAL-ISB045V1T electrical performance . . . . .	3
<b>Table 2.</b>	STEVAL-ISB045V1T evaluation board: connector and test points. . . . .	6
<b>Table 3.</b>	STEVAL-WBCDNGV1 connectors . . . . .	7
<b>Table 4.</b>	STWBC-WA pin description. . . . .	8
<b>Table 5.</b>	SWIM flat ribbon connections for ST-LINK/V2 . . . . .	20
<b>Table 6.</b>	STEVAL-ISB045V1T bill of materials . . . . .	42
<b>Table 7.</b>	STEVAL-WBCDNGV1 bill of materials . . . . .	43
<b>Table 8.</b>	Document revision history . . . . .	51

## List of figures

Figure 1.	STEVAL-ISB045V1 evaluation kit . . . . .	1
Figure 2.	STWBC-WA block diagram . . . . .	3
Figure 3.	STEVAL-ISB045V1T evaluation board: components . . . . .	4
Figure 4.	STEVAL-ISB045V1T evaluation board: top reference designators . . . . .	5
Figure 5.	STEVAL-ISB045V1T evaluation board: bottom reference designators (TP for SWIM connection) . . . . .	6
Figure 6.	STEVAL-WBCDNGV1 dongle components. . . . .	7
Figure 7.	STEVAL-WBCDNGV1: top reference designators . . . . .	7
Figure 8.	STWBC-WA pinout configuration . . . . .	8
Figure 9.	STSW-STWBCGUI installation file . . . . .	10
Figure 10.	Windows Device Manager: COM port selection. . . . .	10
Figure 11.	STSW-STWBCGUI start screen . . . . .	11
Figure 12.	Dongle connection . . . . .	12
Figure 13.	Firmware download via STSW-STWBCGUI . . . . .	12
Figure 14.	Firmware file selection message . . . . .	13
Figure 15.	Firmware file selection . . . . .	13
Figure 16.	Power on message . . . . .	13
Figure 17.	STEVAL-ISB045V1 evaluation kit connection . . . . .	14
Figure 18.	DOS window: download in progress . . . . .	14
Figure 19.	Download success message . . . . .	14
Figure 20.	STSW-STWBCGUI command line. . . . .	15
Figure 21.	STSW-STWBCGUI command line with blank chip. . . . .	16
Figure 22.	STSW-STWBCGUI: convert CAB to STVP files . . . . .	16
Figure 23.	Selecting the CAB file to be converted . . . . .	17
Figure 24.	Selecting the STVP project file name. . . . .	17
Figure 25.	STVP project files . . . . .	18
Figure 26.	STVP configuration . . . . .	19
Figure 27.	ST-LINK connection . . . . .	19
Figure 28.	SWIM connection . . . . .	20
Figure 29.	Target SWIM connector . . . . .	20
Figure 30.	STVP core selection . . . . .	21
Figure 31.	STVP file selection . . . . .	21
Figure 32.	STVP download . . . . .	21
Figure 33.	STVP wrong device selected alert. . . . .	22
Figure 34.	STVP incompatibility device action query . . . . .	22
Figure 35.	STVP download . . . . .	23
Figure 36.	STEVAL-ISB045V1 evaluation kit: test setup configuration . . . . .	24
Figure 37.	Power supply via STEVAL-WBCDNGV1 dongle and PC VBUS. . . . .	24
Figure 38.	External power supply . . . . .	25
Figure 39.	STSW-STWBCGUI: object detected and charge in progress. . . . .	26
Figure 40.	STSW-STWBCGUI: Qi protocol window. . . . .	27
Figure 41.	STSW-STWBCGUI: monitor window . . . . .	27
Figure 42.	STSW-STWBCGUI: parameter window . . . . .	28
Figure 43.	STSW-STWBCGUI: parameter modification . . . . .	29
Figure 44.	STSW-STWBCGUI: saving modified parameters (Dump to bin) . . . . .	30
Figure 45.	STSW-STWBCGUI: bin file backup . . . . .	30
Figure 46.	STSW-STWBCGUI: CAB file patch button . . . . .	31
Figure 47.	STSW-STWBCGUI auto-calibration start . . . . .	33
Figure 48.	STSW-STWBCGUI presence detection test . . . . .	34
Figure 49.	STSW-STWBCGUI presence detection calibration check . . . . .	35
Figure 50.	STEVAL-ISB045V1T test setup. . . . .	36
Figure 51.	Efficiency setup . . . . .	36
Figure 52.	STEVAL-ISB045V1 evaluation board: efficiency vs output power. . . . .	37

<b>Figure 53.</b>	STEVAL-ISB045V1T circuit schematic (1 of 3) . . . . .	38
<b>Figure 54.</b>	STEVAL-ISB045V1T circuit schematic (2 of 3) . . . . .	39
<b>Figure 55.</b>	STEVAL-ISB045V1T circuit schematic (3 of 3) . . . . .	40
<b>Figure 56.</b>	STEVAL-WBCDNGV1 circuit schematic . . . . .	41
<b>Figure 57.</b>	STEVAL-ISB045V1T transmitter main blocks . . . . .	45
<b>Figure 58.</b>	STEVAL-ISB045V1T transmitter: $V_{IN}$ and 5 V power signal routing . . . . .	46
<b>Figure 59.</b>	STEVAL-ISB045V1T transmitter: voltage supply for bridge MOSFETs (zoom). . . . .	47
<b>Figure 60.</b>	STEVAL-ISB045V1T transmitter: large tracks for wireless power coil connection. . . . .	48
<b>Figure 61.</b>	STEVAL-ISB045V1T transmitter: large tracks for wireless power coil connection (zoom) . . . . .	49

**IMPORTANT NOTICE – PLEASE READ CAREFULLY**

STMicroelectronics NV and its subsidiaries (“ST”) reserve the right to make changes, corrections, enhancements, modifications, and improvements to ST products and/or to this document at any time without notice. Purchasers should obtain the latest relevant information on ST products before placing orders. ST products are sold pursuant to ST’s terms and conditions of sale in place at the time of order acknowledgement.

Purchasers are solely responsible for the choice, selection, and use of ST products and ST assumes no liability for application assistance or the design of Purchasers’ products.

No license, express or implied, to any intellectual property right is granted by ST herein.

Resale of ST products with provisions different from the information set forth herein shall void any warranty granted by ST for such product.

ST and the ST logo are trademarks of ST. All other product or service names are the property of their respective owners.

Information in this document supersedes and replaces information previously supplied in any prior versions of this document.

© 2018 STMicroelectronics – All rights reserved