

FEATURES

VC power relays are designed for controlling heavy duty loads safely:

- Contact gap of 3 mm or more
- 2-point contacts for circuits with high inrush current
- Large insulation distance
- Materials used in the terminal and the contact blocks are flame-retardant

Reliable compact build:

- Solenoid contact relays (AC type)
- The lever mechanism and efficient electromagnet configuration allow for a substantially more compact size
- Quiet operation
- Flexible mounting orientation (AC type) → 80% of the rated voltage is guaranteed

- Using the VC mounting bracket saves even more time on installation and maintenance
- Min. 250,000 faultless operations
- UL recognized (File No. E112482: all models)
- cUL certified (File No. E112482: all models)
- TÜV certified (R9551921: all VC15 types) (R9551922: all VC20 types)

TYPICAL APPLICATIONS

- Air-conditioner
- Refrigerator
- Freezer
- Freeze dryer
- Photocopier
- Numeric control machine
- Textile machine
- Elevator
- Power tool

SPECIFICATIONS

Coil input (AC)

Types		VC15	VC15S	VC20	VC20S	
Contact arrangement		4a, 3a1b, 2a2b	3a, 2a1b	4a, 3a1b	3a, 2a1b, 2a, 1a1b, 1a	4a, 3a1b
Maximum contact current	"a" contact (p.f.=1)	15A		20A		
	"b" contact (p.f.=1)	3A		3A		
Terminals		#250 quick connector	3.5 mm dia. screw	#250 quick connector	4 mm dia. screw	
Acceptable wire size	Single wire	1.6 mm (AWG14)		2.0 mm (AWG12)		
	Stranded wire	2.0 mm ² (AWG14)		3.5 mm ² (AWG12)		
Motor loads	1 phase, 120 V	0.4 kW (8A)	UL, cUL 1/3HP	0.75 kW (16A)	UL, cUL 1HP	
	1 phase, 240 V	0.75 kW (8A)	UL, cUL 1HP	1.5 kW (16A)	UL, cUL 2HP	
	3 phase, 240 V	1.5 kW (8A)	UL, cUL 2HP	3.7 kW (16A)	UL, cUL 5HP	
	3 phase, 380 V	1.5 kW (4A)		3.7 kW (8A)		
Resistive loads	1 phase, 120 V	15A	UL, cUL 15A	20A	UL, cUL 20A	
	1 phase, 240 V	15A	UL, cUL 15A	20A	UL, cUL 20A	
	3 phase, 240 V	15A	UL, cUL 15A	20A	UL, cUL 20A	
Tungsten, lamp loads	1 phase, 240 V	6A	UL, cUL 6A	12A	UL, cUL 12A	
Max. operating voltage		IEC 380V AC UL, cUL 300V AC				
Breaking capacity ("a" contact)	3 phase, 240 V (p.f.=0.4)	80A		160A		
	3 phase, 380 V (p.f.=0.4)	40A		80A		
Making capacity ("a" contact)	3 phase, 240 V (p.f.=0.4)	80A		160A		
	3 phase, 380 V (p.f.=0.4)	40A		80A		
Expected life	Electrical (max. rated current)	300,000 operations*				
	Mechanical	1,000,000 operations				
Unit weight (with bracket)		160g	200g	260g	160g	300g
Applicable mounting bracket catalogue No.		BW91543	BW91543	BW92043	BW91543	BW92043

Coil input (DC)

Types		VC15		VC20		Remarks
Contact arrangement		4a, 3a1b		2a, 1a1b		
Maximum contact current	"a" contact (p.f.=1)	15A		20A		
	"b" contact (p.f.=1)	3A		3A		
Terminals		#250 quick connector				
Acceptable wire size	Single wire	1.6 mm (AWG14)		2.0 mm (AWG12)		
	Stranded wire	2.0 mm ² (AWG14)		3.5 mm ² (AWG12)		
Motor loads	1 phase, 120 V	0.4 kW (8A)	UL, cUL 1/3HP	0.75 kW (16A)	UL, cUL 1HP	
	1 phase, 240 V	0.75 kW (8A)	UL, cUL 1HP	1.5 kW (16A)	UL, cUL 2HP	
	3 phase, 240 V	1.5 kW (8A)	UL, cUL 2HP	—	—	
	3 phase, 380 V	1.5 kW (4A)	—	—	—	
Resistive loads	1 phase, 120 V	15A	UL, cUL 15A	20A	UL, cUL 20A	
	1 phase, 240 V	15A	UL, cUL 15A	20A	UL, cUL 20A	
	3 phase, 240 V	15A	UL, cUL 15A	—	—	
Tungsten, lamp loads	1 phase, 240 V	6A	UL, cUL 6A	12A	UL, cUL 12A	
Max. operating voltage		IEC 380V AC UL, cUL 300V AC				
Breaking capacity ("a" contact)	3 phase, 240 V (p.f.=0.4)	80A		—		IEC AC3
	3 phase, 380 V (p.f.=0.4)	40A		—		
Making capacity ("a" contact)	3 phase, 240 V (p.f.=0.4)	80A		—		IEC AC3
	3 phase, 380 V (p.f.=0.4)	40A		—		
Expected life	Electrical (max. rated current)	300,000 operations*				
	Mechanical	1,000,000 operations				
Unit weight (with bracket)		170g		130g		
Applicable mounting bracket catalogue No.		BW91543		BW91543		

Note: *Except for 12 A of lamp loads. In this case the expected life is 100,000 operations.

CONTACT ARRANGEMENTS

Type	No. of poles	Contacts	Contact Arrangements
VC15	4P	4a	
		3a1b	
		2a2b	
	3P	3a	
		2a1b	
		1a1b	
VC15S	4P	4a	
		3a1b	
	1P	1a	
VC20	4P	4a	
		3a1b	
		2a	
	3P	3a	
		2a1b	
		1a1b	
VC20S	4P	4a	
		3a1b	
	2P	2a	
VC20-DC	2P	2a	
		1a1b	

Note: Inquire separately regarding TÜV certified models.

COIL DATA (at 20°C)**AC coils (EX. 240V AC)**

Types		VC20 (2a, 1a1b, 1a)		VC15, VC15S, VC20 (3a, 2a1b)		VC20 (4a, 3a1b), VC20S		
Nominal coil voltage		240V AC		240V AC		240V AC		
Frequency, Hz		60	50	60	50	60	50	
Coil input (max.)	Inrush	mA	67.5	80.8	87.5	104	133	146
		VA	16.2	19.4	21	25	32	35
	Sealed	mA	22.5	26.7	25	30	32.5	38.3
		VA	5.4	6.4	6	7.2	7.8	9.2
Pick-up voltage, V AC (max.) Cold		192	192	192	192	192	192	
Drop-out voltage, V AC (min.)		48	48	48	48	48	48	

DC coils (24V DC)

Types	VC15 (4a, 3a1b)	VC20 (2a, 1a1b)
Nominal coil voltage	24V DC	24V DC
Coil capacity (±10%)	3.3W	3.3W
Pick-up voltage, V DC (max.) Cold	19.2	19.2
Drop-out voltage, V DC (min.)	2.4	2.4

CHARACTERISTICS (AC, DC common)

Max. operate time	25ms*	Switching speed Electrical Mechanical	1,200 times/hour 14,400 times/hour
Max. release time	25ms		
Contact bounce time	Average 5 ms or less	Ambient temp. (max. humidity)	-10° C to +40° C (max. 85% R.H.) +40° C to +55° C (max. 75% R.H.)
Dielectric strength Between open contacts (inc. coil terminal) Between load & source with open contacts	2,500 Vrms (Initial)		
	2,500 Vrms (Initial)		
Insulation resistance Between open contacts (inc. coil terminal) Between load & source with open contacts	Over 100 MΩ (initial) at 500 V DC		
	Over 100 MΩ (initial) at 500 V DC		

Remark: *VC15 DC type: 30 ms.

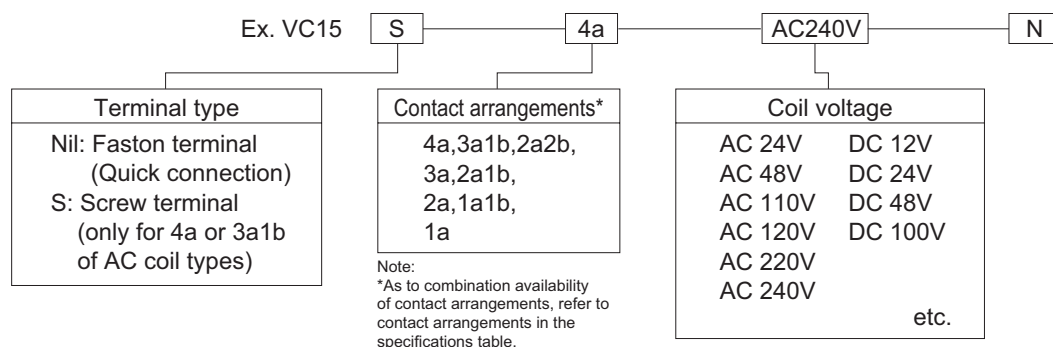
ORDERING INFORMATION**TYPES****AC coils (EX. 240V AC)**

Contact arrangements	Types	VC15	VC15S	VC20	VC20S
4P	4a	VC15-4a-AC240V-N	VC15S-4a-AC240V-N	VC20-4a-AC240V-N	VC20S-4a-AC240V-N
	3a1b	VC15-3a1b-AC240V-N	VC15S-3a1b-AC240V-N	VC20-3a1b-AC240V-N	VC20S-3a1b-AC240V-N
	2a2b	VC15-2a2b-AC240V-N	—	—	—
3P	3a	VC15-3a-AC240V-N	—	VC20-3a-AC240V-K-N	—
	2a1b	VC15-2a1b-AC240V-N	—	VC20-2a1b-AC240V-N	—
2P	2a	—	—	VC20-2a-AC240V-N	—
	1a1b	—	—	VC20-1a1b-AC240V-N	—
1P	1a	—	—	VC20-1a-AC240V-N	—

VC

DC coils (EX. 24V DC)

Contact arrangements	Types	VC15	VC20
4P	4a	VC15-4a-DC24V-N	—
	3a1b	VC15-3a1b-DC24V-N	—
2P	2a	—	VC20-2a-DC24V-N
	1a1b	—	VC20-1a1b-DC24V-N

DIMENSIONS

AC type mm

VC15 / VC20

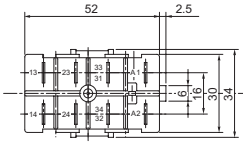

VC15 (4P)

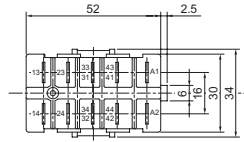

VC15S (4P)

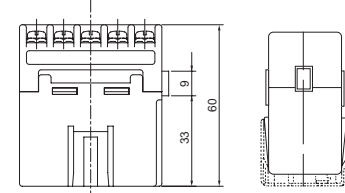
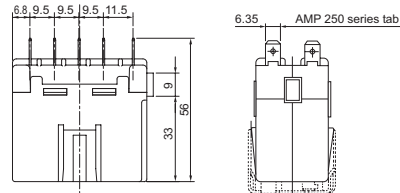
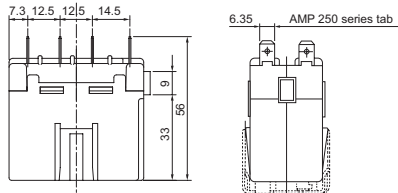
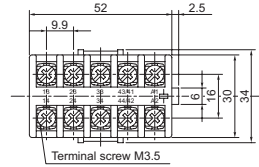

VC20 (4P)

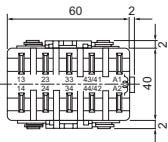

VC20S (4P)

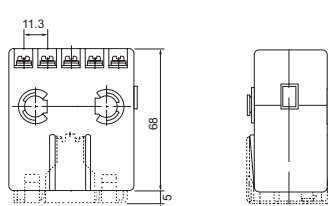
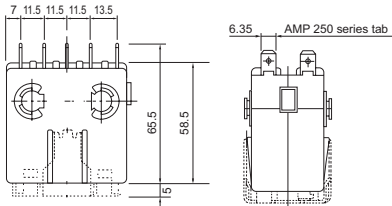
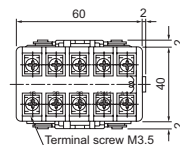

Mounting brackets
BW91543 (BW92043)
(included in delivered set)

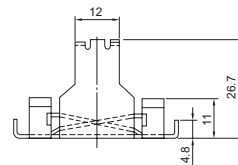
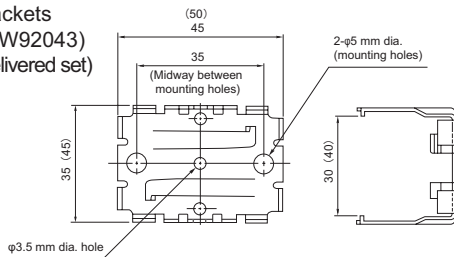

Mounting bracket	Suitable VC relay
BW91543	VC15(3P) VC15(4P)
	VC15S(4P) VC20(3P)
	VC20(4P) VC20(2P)
BW92043	VC20(4P) VC20S(4P)

Dimensions for the BW9204 are given in parentheses ().

DC type mm

VC20

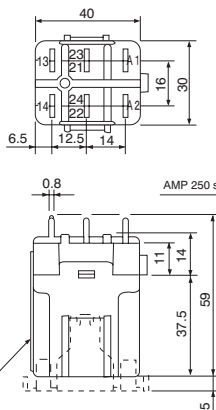

VC15

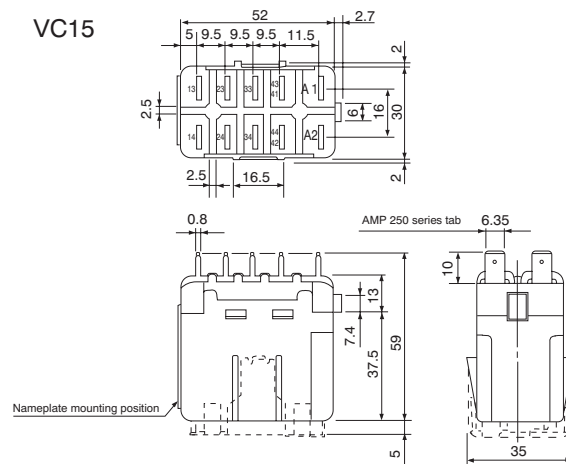

CAUTIONS FOR USE

General Usage Conditions

- Ambient temperature (relative humidity):
–10°C–40°C (45%–85% RH)
40°C–55°C (45%–75% RH)
(No condensation or freezing)
- Elevation: 2,000 m or less
- Operating circuit voltage fluctuation range:
80%–110% of rated voltage (cold state)
- Rated frequency: 50/60 Hz

Notes on relay selection

- Select a relay such that the load capacity is within the rating of the solenoid switch.
- At the maximum rated motor capacity, the product has an electrical switching durability (service life) of 250,000 operations or more. This is suitable for consumer and light industrial applications.
- In certain usage environments (temperature, humidity, oil mist, etc.), the service life of the contacts may be shortened. For applications such as industrial machinery where the usage environment is poor, select a model that provides some performance margin. Contact your National dealer for assistance when making a selection.
- These relays are not suitable for applications such as inching or plugging.
- Using the wrong coil voltage can cause the coil to burn out. Particular care should be taken when selecting the coil voltage in cases where the main circuit and operating circuit have different voltages.
- When choosing a thermal relay, make sure the current adjustment range is appropriate for the full load current of the motor, regardless of the voltage of the main circuit. Operation cannot be guaranteed if the motor is outside the current adjustment range.
- The relays are sealed type units and are adjusted at the factory. They are not intended to be disassembled by the user. It is not possible to replace individual contacts or coils.
- The minimum usable current is the approximate lower limit value at which switching operation is possible at very small load levels. The actual minimum usable current may differ depending on factors such as the usage environment. Relays should therefore be tested at the actual load level before use.

Installation notes

Mounting

- Mechanical shocks from being dropped, etc., can cause malfunctions. Handle relays with care.

- Avoid using relays in extreme environments, such as locations subject to excessive heat, humidity, dust, corrosive gases, vibrations, mechanical shocks, or direct sunlight.
- Avoid using relays in locations where they could be exposed to rain or water spray. (Such conditions could cause malfunctions.)
- As shown in Figure 1, secure the ends of the mounting plate to the mounting bracket using 4 mm screws, then snap the relay into place. To remove the relay, carefully pry loose the hook of the mounting bracket with the tip of a screwdriver, as shown in Figure 2, and then pull the relay out. (Do not to apply too much force with the screwdriver to avoid bending the mounting bracket.)

Figure 1 Mounting bracket

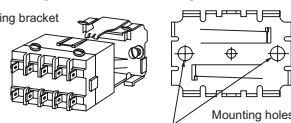
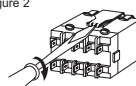

Figure 2



- When relays are mounted side-by-side horizontally, the operation indicators are located on the side. Therefore, they should be positioned at least 5 mm apart, as shown in Figure 3. In addition, when they are mounted side-by-side vertically, as shown in Figure 4, make sure to leave sufficient space in between them to allow insertion of a screwdriver to remove the mounting brackets.

Figure 3

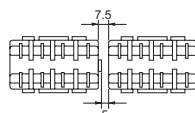
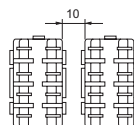

Figure 4



Wiring connections

- Connections to screw terminals

Terminal dimensions	Terminal screw	Max. connection wire	Suitable crimp-type terminal	Standard tightening torque
	Up terminal M3.5	φ 1.6 2 mm ²	2-3.5 2Y-3.5	0.8-1.2N·m (8.2-12.3kgf·cm)
	Full-up terminal M4	φ 2 3.5 mm ²	3.5-4	1.2-1.8N·m (12.2-18.3kgf·cm)

- Plug-in terminal connections

- 1) When removing a VC relay from the socket, pull it straight out. Pulling the relay out at an angle could bend the plug-in terminals.
- 2) The receptacles listed in the table below may be used with relays having plug-in terminals. However, the

VC15(4P) should not be used with a receptacle tab because the insulation distance cannot be guaranteed.

- 3) Insert the receptacle firmly to prevent it from loosening. Removal requires a pulling force of 2 to 4 kg, so avoid trying to remove two at the same time. Make sure to remove only one at a time.
- 4) Avoid applying solder to terminals.

Figure 5

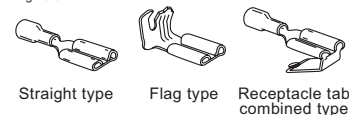

Model	AMP 250 series receptacle
VC15	Straight type, flag type, receptacle tab combined type
VC20	Straight type, flag type, receptacle tab combined type
VC15 (4P)	Straight type, flag type
VC20 (4P)	Straight type, flag type, receptacle tab combined type

Figure 6

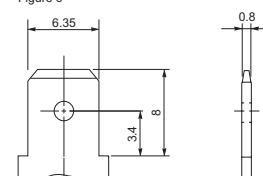

Usage precautions

- If there is concern that contact problems (fusing, open-phase, etc.) or the auto-reset operation of thermal relays could cause secondary damage, appropriate safeguards should be built into the system.
- Make sure not to confuse the terminal positions when using relays. The terminals are marked on the nameplate. Be particularly careful regarding the positions of terminal b and the coil terminal.
- Circuits through which current is flowing continuously for long periods due to the operation of the relay, etc., should be designed so that they are in a non-excited state when left idle. (Examples include circuits for emergency lamps, warning devices, and fault detectors that reset only in case of emergency and use terminal b to issue warnings.)

Maintenance and inspection

- Due to the danger of electric shock, always shut off power when performing maintenance or inspections.
- Periodically retighten terminal screws to prevent the possibility of overheating or fire due to loosening.
- If there is concern that contact problems (fusing, open-phase, etc.) could cause secondary damage, perform checks regularly and replace relays as soon as any problems are discovered.
- If a thermal relay is tripped, correct the problem and then lightly press the reset button to restart operation.

APPLICATION NOTES

1. Air-conditioner

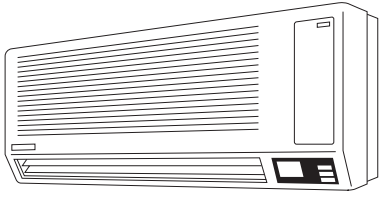

- Features
- VC relays were developed for use in air-conditioners.
- Used for switching the compressor and fan ON and OFF.
- Also used in commercial air-conditioners having separate indoor and outdoor units.
- VC20-AC type is recommended.

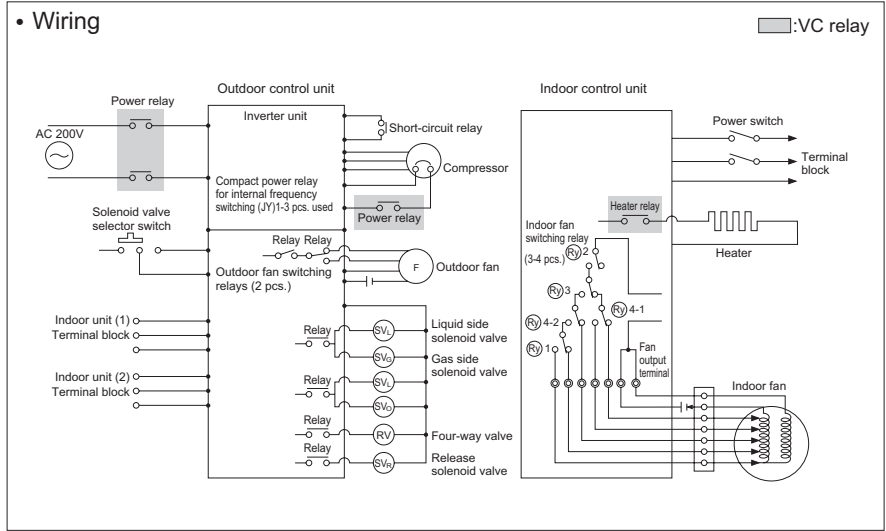

2. Freezer/Refrigerator

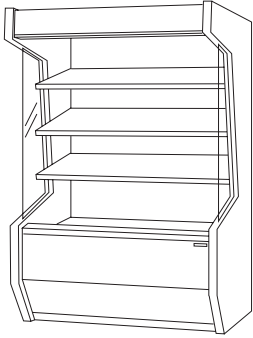

- Features
- Used as relays for compressor starting.
- VC20-AC type is recommended.

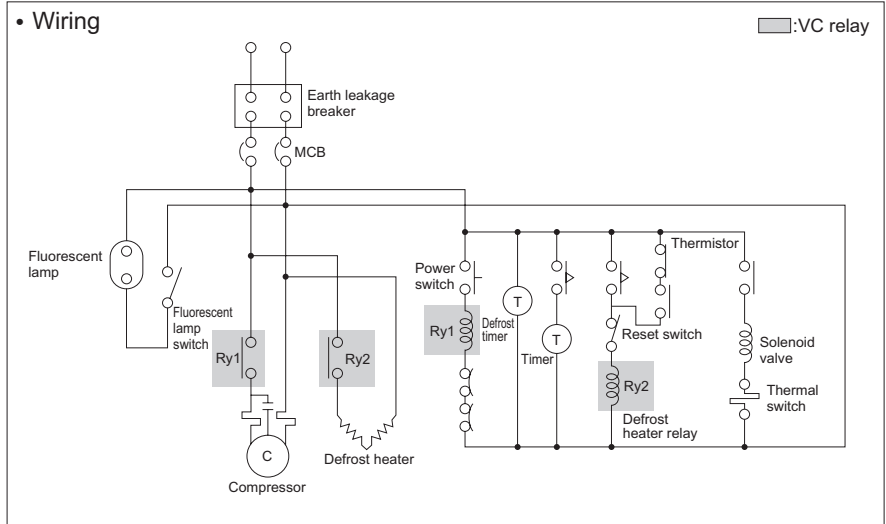

3. Photo copy machine

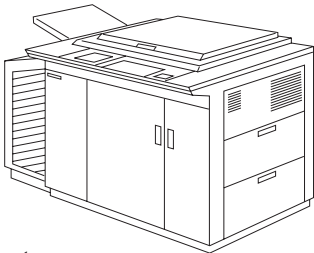

- Features
- IEC standards emphasize safety and may require a contact gap of at least 4 mm.
- Note: Inquire separately when a contact gap of 4 mm or larger is required.
- Used as power relays of the main circuit.
- VC15-DC type is recommended.

