

5

4

3

2

1

D

C

B

A

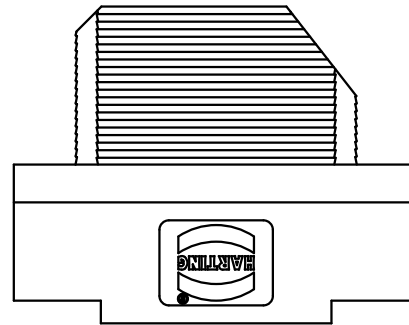

Hood lower part

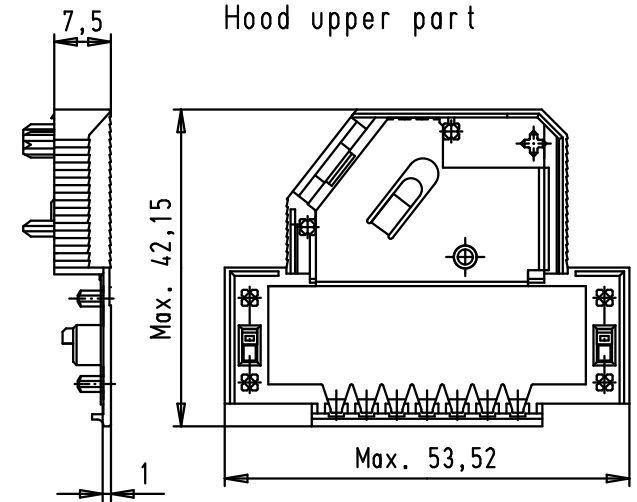
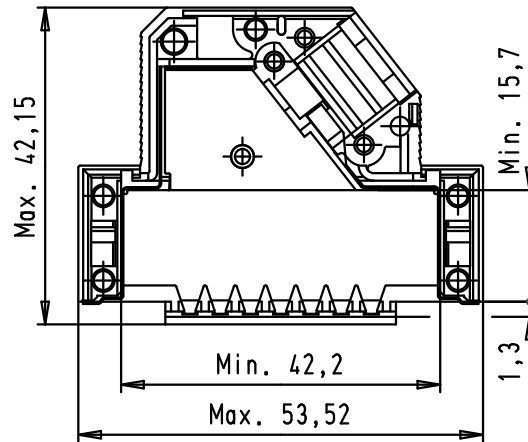
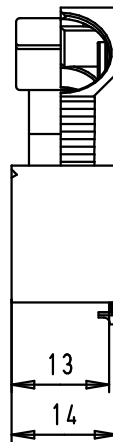
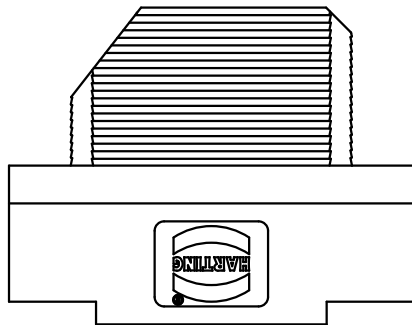

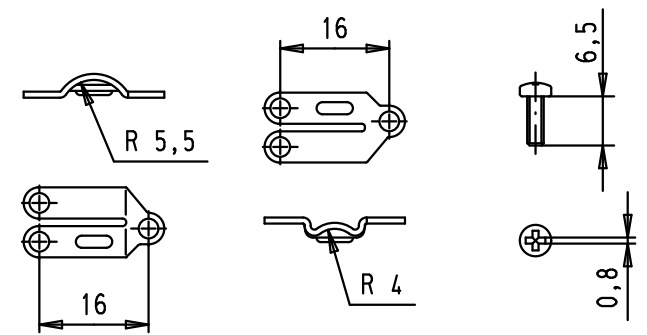

Hood upper part



Strain relief 1

Strain relief 2

Flathead screws

				Dot.	Name	 All Dim. in mm Orig. Size DIN A 4	D-Sub Hoods 25 Poles Shielded	Maßstab/ Scale  1:1
			Detail.	27/02/03	SH			
			Insp.					
EC01696	20/04/10	SC	Stand.				TB 09 67 025 0573	Blatt/ Page 1 / 1
33806	26/09/06	PK	HARTING EURL					
31392	27/02/03	SH	F-95972 Paris					
Mod.	Dot.	Name			Sub.			