



Eval Kit Manual

AS5147P

Adapter Board

AS5147P-TS_EK_AB

Table of Contents

1	Introduction	3
1.1	Kit Content	3
2	Board description	4
2.1	Mounting the AS5147P adapter board.....	5
3	AS5147P adapter board and pinout.....	6
4	Operation case.....	7
4.1	One device SPI mode, unidirectional – 3 wire	7
4.2	One device SPI mode, bidirectional – 4 wire	8
5	AS5147P-TS_EK_AB Hardware.....	9
5.1	AS5147P-TS_EK_AB schematics	9
5.2	AS5147P-TS_EK_AB PCB layout	10
6	Ordering & Contact Information	11
7	Copyrights & Disclaimer.....	12

Revision History

Revision	Date	Owner	Description
1.0	14.01.2014	mzie	Initial version

1 Introduction

The AS5147P adapter board is a small PCB allowing simple and quick testing or evaluation of the AS5147P magnetic position sensor without the need to build a test fixture or design an own PCB.

1.1 Kit Content

Figure 1: Kit content

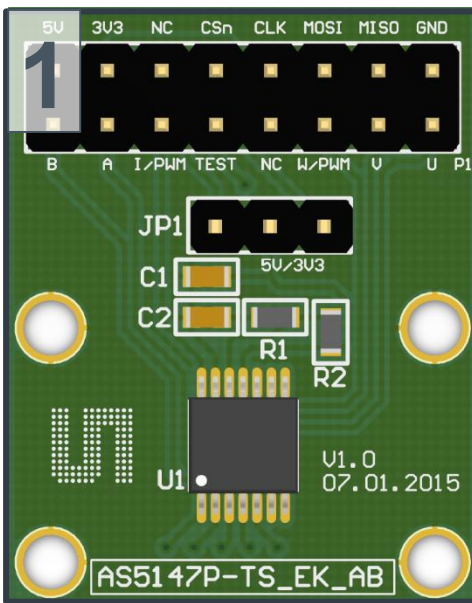

Pos.	Item	Comment
1	AS5147P-TS_EK_AB	Adapter board
2	AS5000-MD6H-2	Diametric Magnet, D6x2.5mm, NdFeB, Bomatec AG

2 Board description

The PCB can either be connected to an external microcontroller or to the USB I&P Box which is available on our webpage. ([USB I&P Box](#))

P1 has to be populated with a 2x8 pin header and is required for power supply as well as SPI, ABI, UVW/PWM interfaces.

The connector JP1 allows to select between 5V or 3.3V operation.

R1 and R2 are 0 ohm resistors in 0603 package. Depending on the supply voltage either R1 or R2 has to be populated. For 5V operation R1 has to be populated and R2 has to be removed (default case). Vice versa for 3.3V operation.

Figure 2: AS5147P adapter board

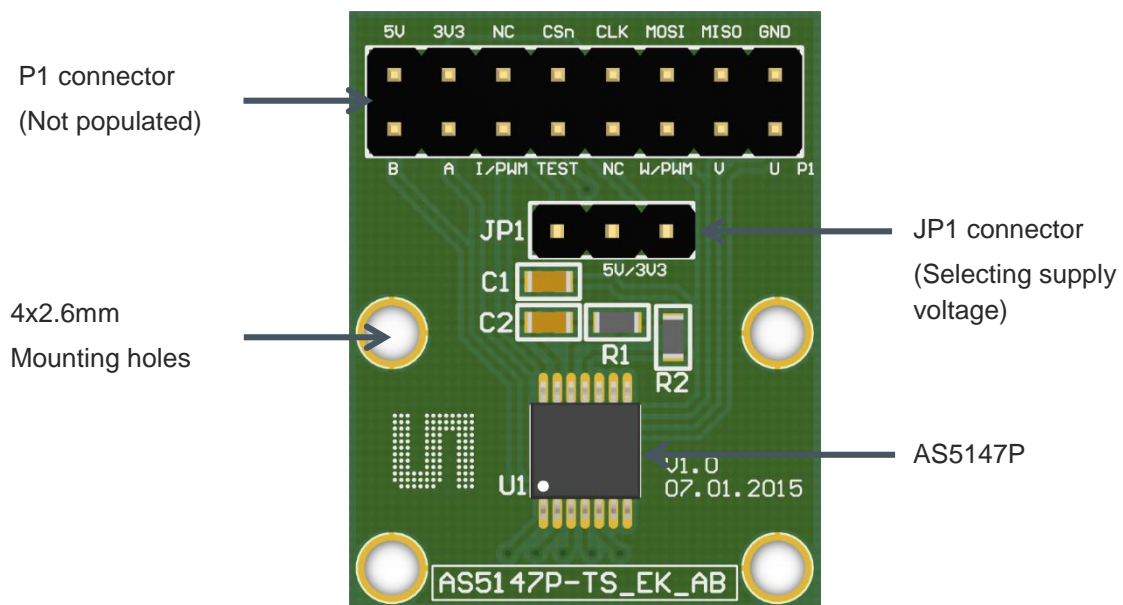

2.1 Mounting the AS5147P adapter board

Figure 3: Mounting and dimensions

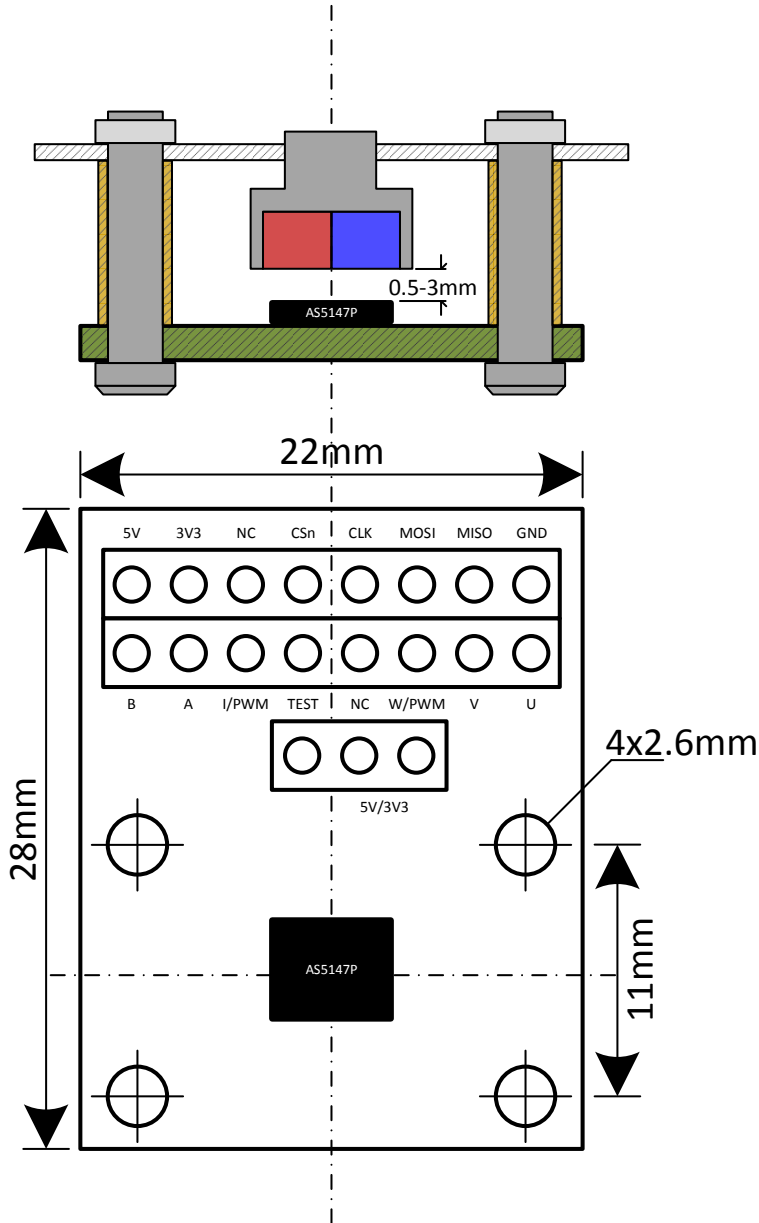

A 6x2.5mm diametric magnet must be placed over or under the AS5147P sensor, and should be centered on the middle of the package with a tolerance of 0.5mm. The airgap between the magnet surface and the package should be maintained in the range 0.5mm to 3mm. The magnet holder must not be ferromagnetic. Materials as brass, copper, aluminum, stainless steel are the best choices to make this part.

3 AS5147P adapter board and pinout

Figure 4: AS5147P adapter board and sensor pinout

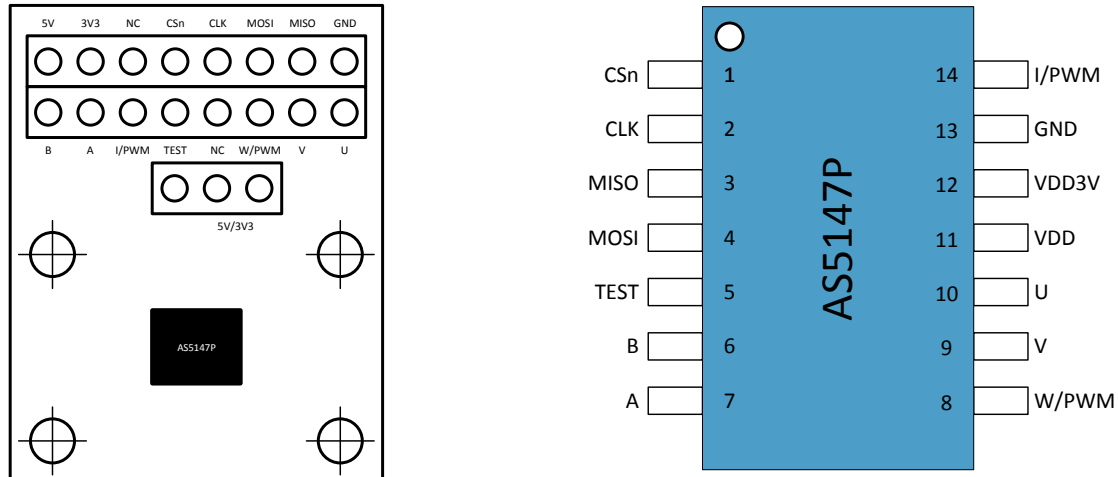

Pin# Board	Pin# AS5147P	Symbol board	Type	Description
P1 - 1	11	5V	Power supply	Positive supply voltage
P1 - 2	12	3V3	Power supply	3.3V LDO output
P1 - 3		NC		Not connected
P1 - 4	1	CSn	Digital input	SPI chip select (active low)
P1 - 5	2	CLK	Digital input	SPI Clock
P1 - 6	4	MOSI	Digital input	SPI MOSI
P1 - 7	3	MISO	Digital output	SPI MISO
P1 - 8	13	GND	Power supply	Ground
P1 - 9	6	B	Digital output	Incremental signal B (quadrature)
P1 - 10	7	A	Digital output	Incremental signal A (quadrature)
P1 - 11	14	I/PWM	Digital output	Incremental signal I (index) or PWM
P1 - 12	5	TEST		Test pin
P1 - 13		NC		Not connected
P1 - 14	8	W/PWM	Digital output	Commutation signal W or PWM
P1 - 15	9	V	Digital output	Commutation signal V
P1 - 16	10	U	Digital output	Commutation signal U

4 Operation case

4.1 One device SPI mode, unidirectional – 3 wire

The AS5147P adapter board can be directly connected to an industry standard SPI port of a microcontroller. The minimum connection requirements for unidirectional communication between the microcontroller and the AS5147P are MISO, CLK, CSn. In this case the MOSI pin is tied to VDD which will result in reading only the 14-bit Angle Register (0x3FFF). See AS5147P datasheet register table, register 0x3FFF.

Figure 5: One device SPI mode, unidirectional – 3 wire

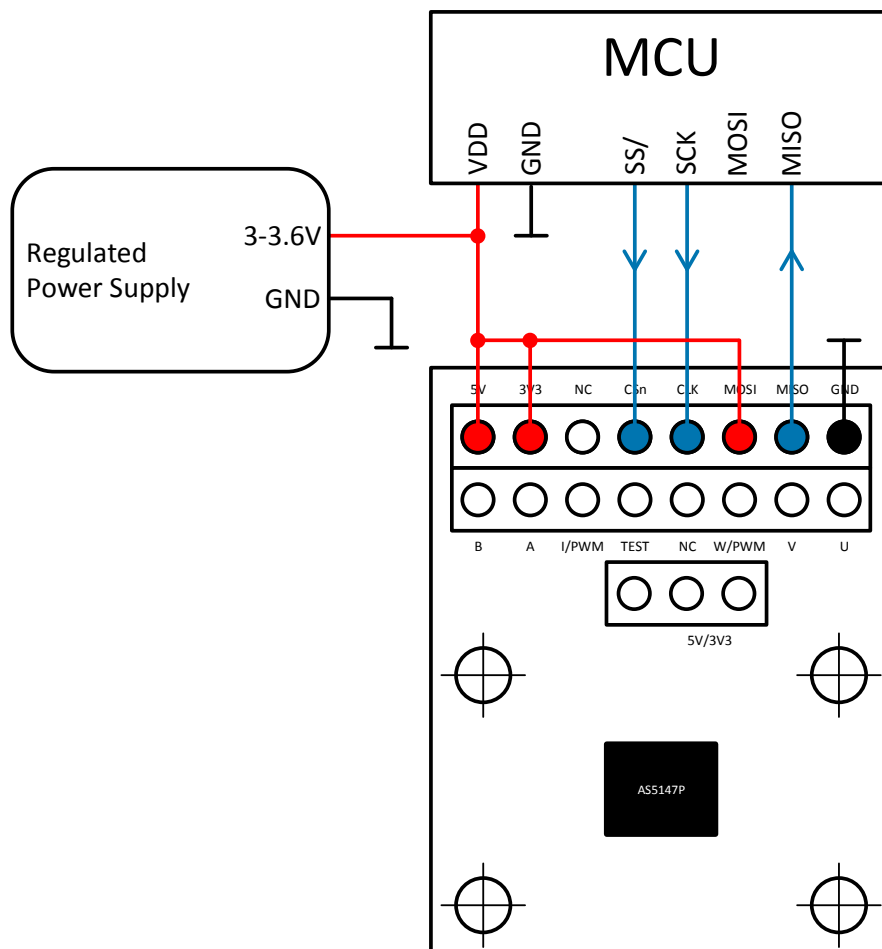

4.2 One device SPI mode, bidirectional – 4 wire

If it's needed to read other registers than the Angle Register (0x3FFF) or to write to registers of the AS5147P the MOSI connection is required.

Figure 6: One device SPI mode, bidirectional – 4 wire

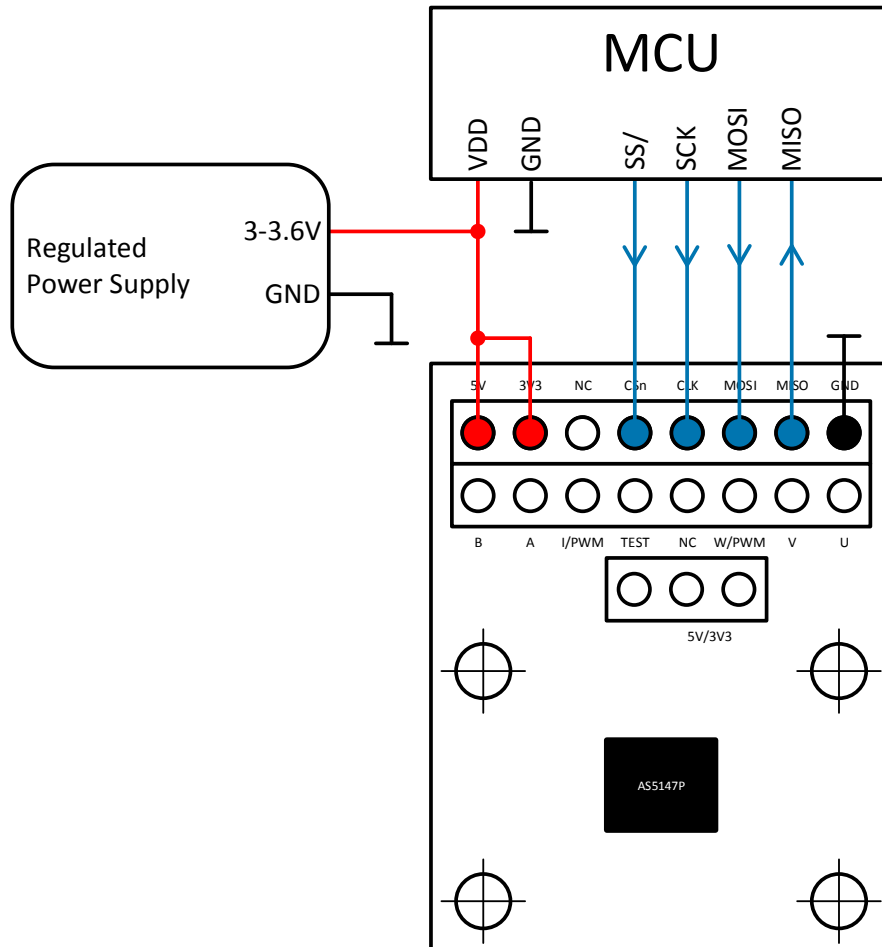

5 AS5147P-TS_EK_AB Hardware

5.1 AS5147P-TS_EK_AB schematics

Figure 7: AS5147P-TS_EK_AB schematics

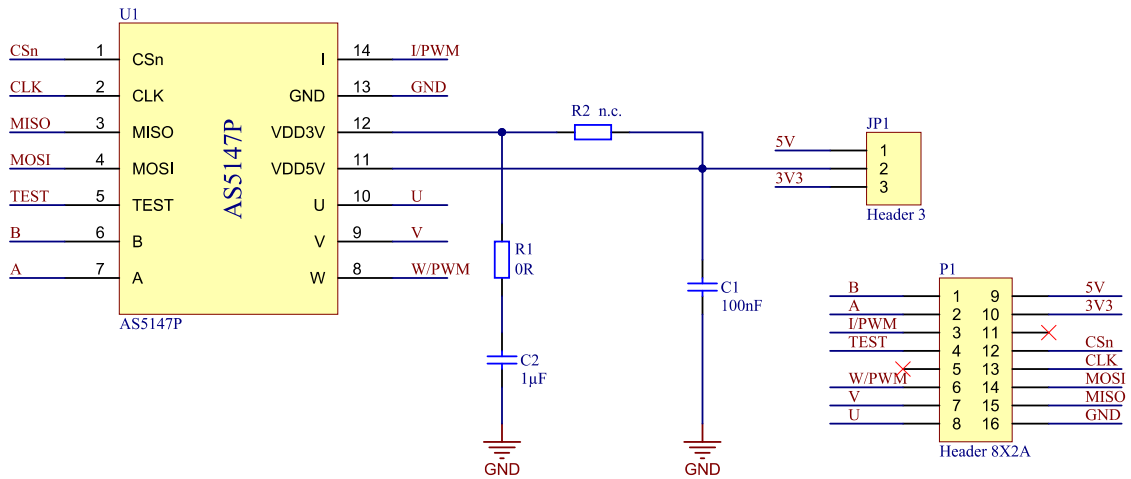

5.2 AS5147P-TS_EK_AB PCB layout

Figure 8: AS5147P-TS_EK_AB PCB layout

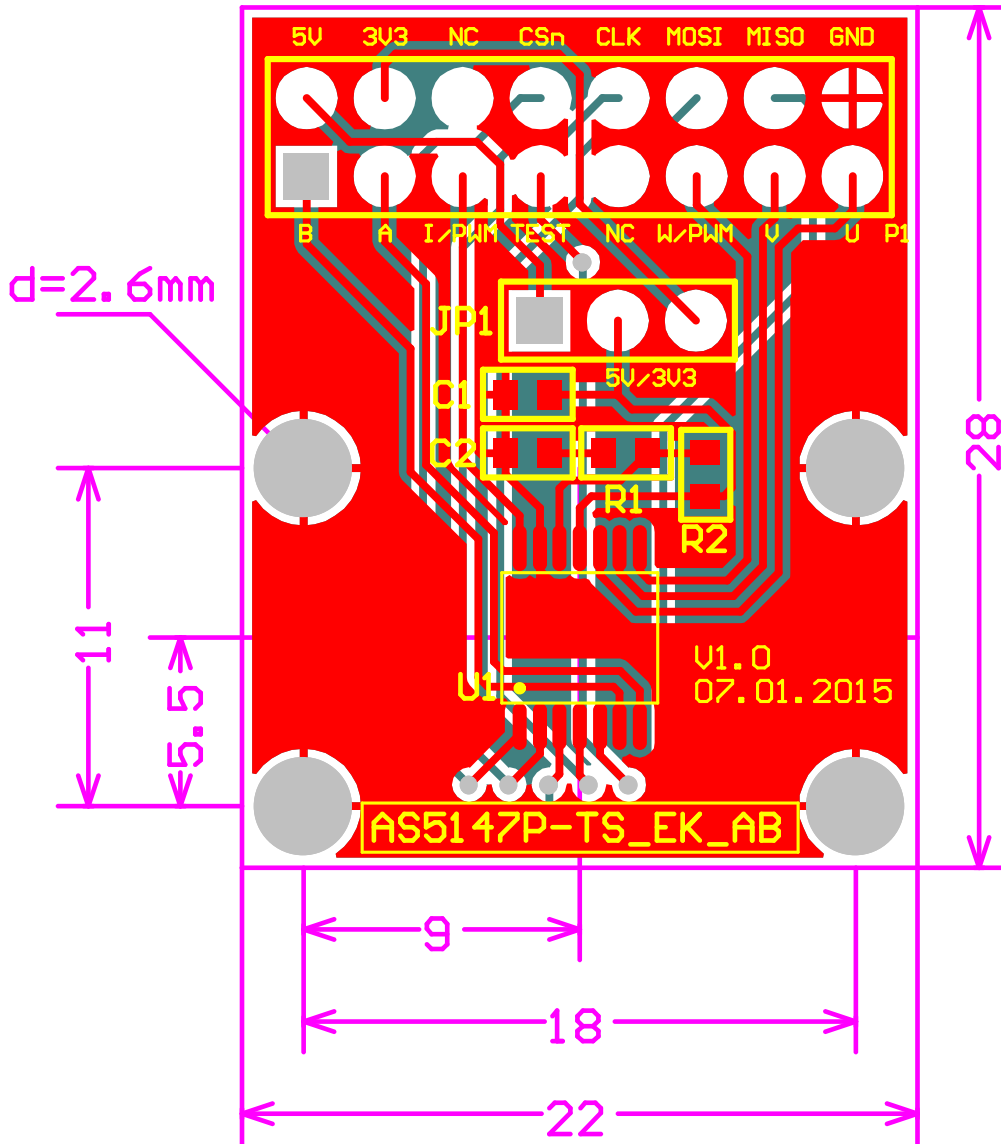

6 Ordering & Contact Information

Ordering Code	Description
AS5147P-TS_EK_AB	AS5147P Eval Kit Adapter Board

Buy our products or get free samples online at:

www.ams.com/ICdirect

Technical Support is available at:

www.ams.com/Technical-Support

Provide feedback about this document at:

www.ams.com/Document-Feedback

For further information and requests, e-mail us at:

ams_sales@ams.com

For sales offices, distributors and representatives, please visit:

www.ams.com/contact

Headquarters

ams AG

Tobelbaderstrasse 30

8141 Unterpemstaetten

Austria, Europe

Tel: +43 (0) 3136 500 0

Website: www.ams.com

7 Copyrights & Disclaimer

Copyright ams AG, Tobelbader Strasse 30, 8141 Unterpremstaetten, Austria-Europe. Trademarks Registered. All rights reserved. The material herein may not be reproduced, adapted, merged, translated, stored, or used without the prior written consent of the copyright owner.

Demo Kits, Evaluation Kits and Reference Designs are provided to recipient on an “as is” basis for demonstration and evaluation purposes only and are not considered to be finished end-products intended and fit for general consumer use, commercial applications and applications with special requirements such as but not limited to medical equipment or automotive applications. Demo Kits, Evaluation Kits and Reference Designs have not been tested for compliance with electromagnetic compatibility (EMC) standards and directives, unless otherwise specified. Demo Kits, Evaluation Kits and Reference Designs shall be used by qualified personnel only.

ams AG reserves the right to change functionality and price of Demo Kits, Evaluation Kits and Reference Designs at any time and without notice.

Any express or implied warranties, including, but not limited to the implied warranties of merchantability and fitness for a particular purpose are disclaimed. Any claims and demands and any direct, indirect, incidental, special, exemplary or consequential damages arising from the inadequacy of the provided Demo Kits, Evaluation Kits and Reference Designs or incurred losses of any kind (e.g. loss of use, data or profits or business interruption however caused) as a consequence of their use are excluded.

ams AG shall not be liable to recipient or any third party for any damages, including but not limited to personal injury, property damage, loss of profits, loss of use, interruption of business or indirect, special, incidental or consequential damages, of any kind, in connection with or arising out of the furnishing, performance or use of the technical data herein. No obligation or liability to recipient or any third party shall arise or flow out of ams AG rendering of technical or other services.