



EVERLIGHT ELECTRONICS CO.,LTD.

Device Number : DLE-125-102 REV: 1.0

3.0mm Bi-Color (Multi-Color)With common Cathode(2mm Lead pitch) LED, T-1

MODEL NO : 1259-7SURSYGW/S530-A2 ECN : _____ Page: 1/5

■ Features :

- Two chips are matched for uniform light output, wide viewing angle
- Long life-solid state reliability
- I.C. compatible/Low power consuming

■ Description :

- The 1259-7 LED lamp contain two integral chips and are available as both bicolor and bipolar types.
- The Hyper Red and Super Yellow Green Light is emitted by diodes of AlGaInP and AlGaInP respectively.
- Type of bipolar lamps are both white diffused and color diffused while the bicolor are white diffused.

■ Applications :

- TV set
- Monitor
- Telephone
- Computer

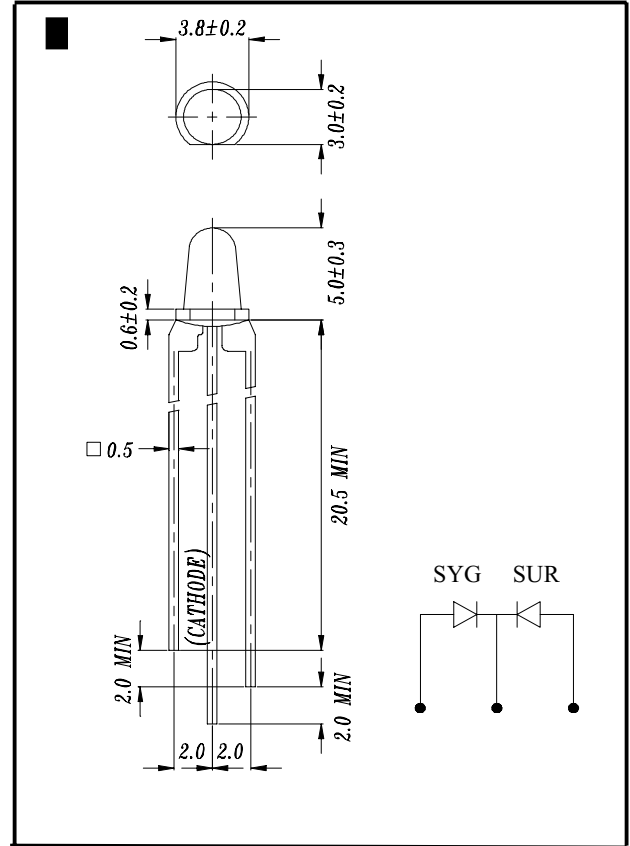

■ NOTES :

- 1.All dimensions are millimeters.
- 2.An epoxy meniscus may extend about is 1.5mm(0.059") down the lead.

PART NO	CHIP		Lens Color
	Material	Emitted Color	
1259-7SURSYGW/S530-A2	AlGaInP	Hyper Red	White Diffused
	AlGaInP	Super Yellow Green	

DESIGNER	CHECKER	APPROVER

Office : NO 25,Lane 76,Chung Yang Rd,Sec.3
Tucheng,Taipei 236,Taiwan,R.O.C.

TEL : 886-2-2267-2000,2266-9936(22 Lines)
FAX : 886-2-2267-6189



EVERLIGHT ELECTRONICS CO.,LTD.

Device Number : DLE-125-102 REV: 1.0

3.0mm Bi-Color (Multi-Color)With common Cathode(2mm Lead pitch) LED, T-1

MODEL NO : 1259-7SURSYGW/S530-A2

ECN : Page: 2/5

■ Absolute Maximum Ratings at Ta = 25°C

Parameter	Symbol	Rating	Unit
Forward Current	If	SUR 25	mA
		SYG 25	
Operating Temperature	Topr	-40 to +85	°C
Storage Temperature	Tstg	-40 to +100	°C
Soldering Temperature	Tsol	260 ± 5	°C
Electrostatic Discharge	ESD	2000	V
Power Dissipation	Pd	SUR 60	mW
		SYG 60	
Peak Forward Current (Duty 1/10 @ 1KHZ)	If(Peak)	SUR 160	mA
		SYG 160	
Reverse Voltage	Vr	5	V

■ Electronic Optical Characteristics :

Parameter	Symbol	MIN.	TYP.	MAX.	Unit	Condition
Luminous Intensity	Iv	SUR 25.00	50.00	/	mcd	If= 20 mA
		SYG 16.00	32.00	/		
Viewing Angle	2θ 1/2	/	30	/	deg	If= 20 mA
Peak Wavelength	λ p	SUR /	632	/	nm	If= 20 mA
		SYG /	575	/		
Dominant Wavelength	λ d	SUR /	624	/	nm	If= 20 mA
		SYG /	573	/		
Spectrum Radiation Bandwidth	Δ λ	SUR /	20	/	nm	If= 20 mA
		SYG /	20	/		
Forward Voltage	Vf	SUR /	2.0	2.4	V	If= 20 mA
		SYG /	2.0	2.4		
Reverse Current	Ir	/	/	10	μ A	Vr= 5 V



EVERLIGHT ELECTRONICS CO.,LTD.

Device Number : DLE-125-102 REV: 1.0

3.0mm Bi-Color (Multi-Color)With common Cathode(2mm Lead pitch) LED, T-1

MODEL NO : 1259-7SURSYGW/S530-A2 ECN : _____ Page: 3/5

Typical Electro-Optical Characteristic Curves

SUR

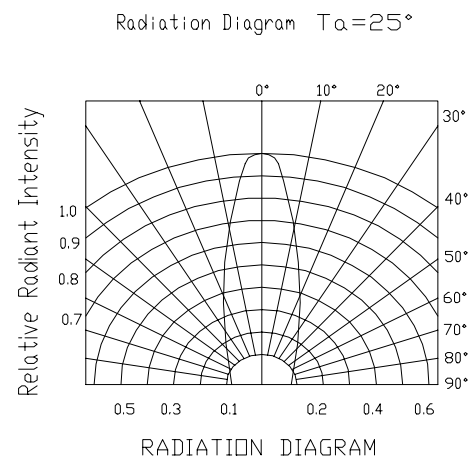
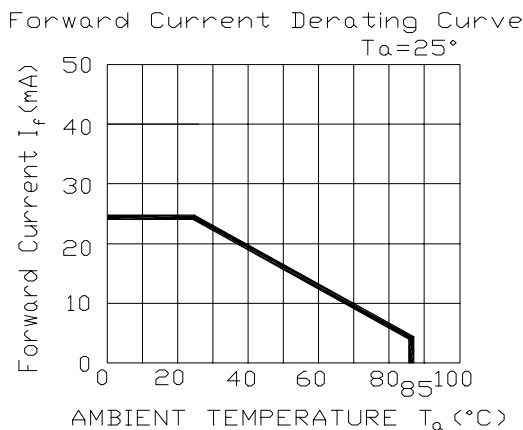
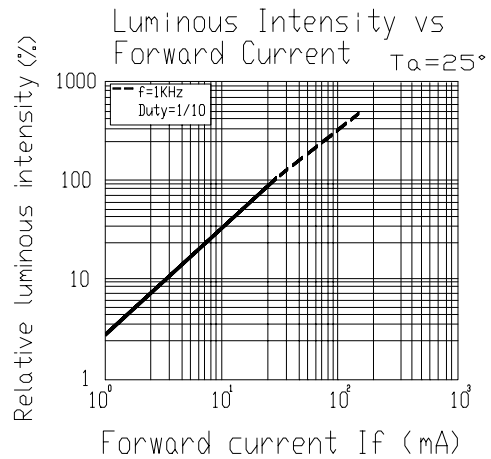
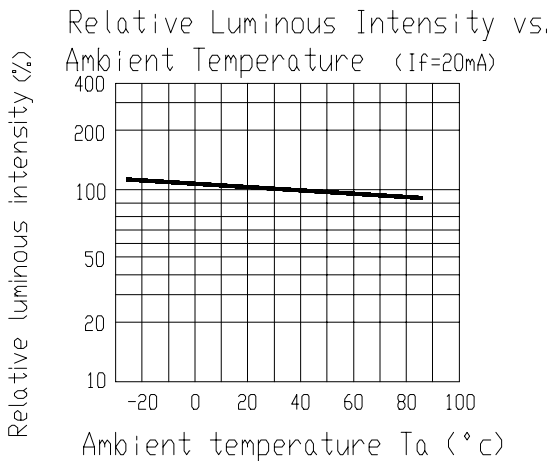
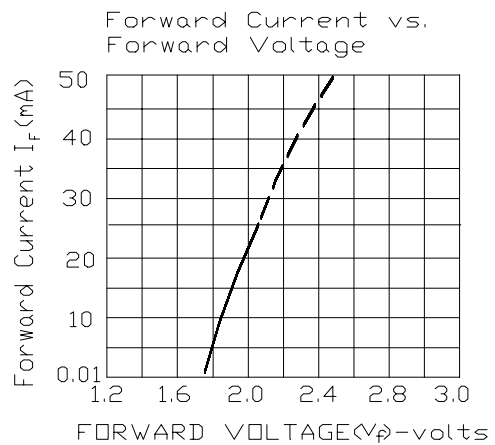
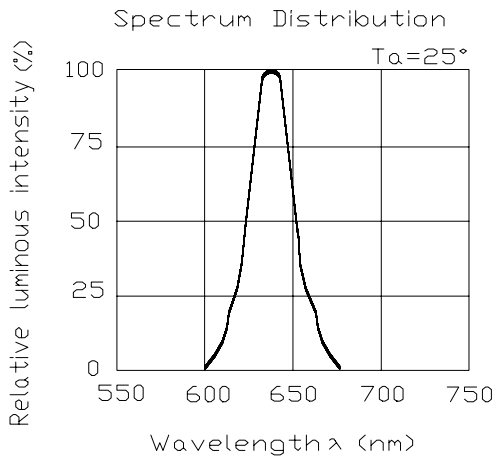



EVERLIGHT ELECTRONICS CO.,LTD.

Device Number : DLE-125-102 REV: 1.0

3.0mm Bi-Color (Multi-Color)With common Cathode(2mm Lead pitch) LED, T-1

MODEL NO : 1259-7SURSYGW/S530-A2 ECN : _____ Page: 4/5

■ Typical Electro-Optical Characteristic Curves

SYG

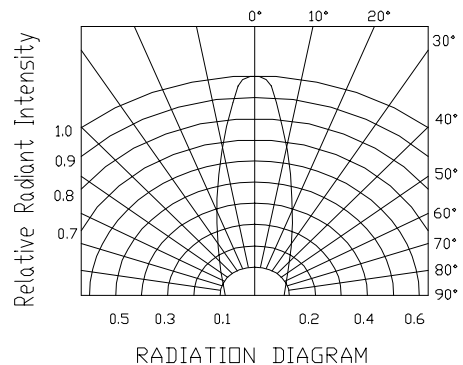
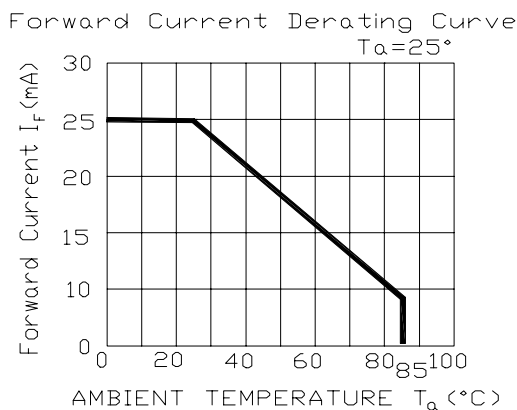
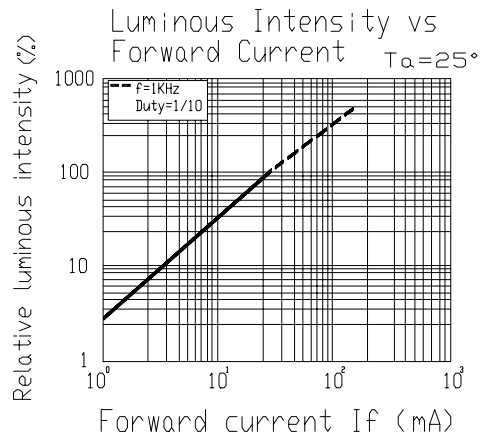
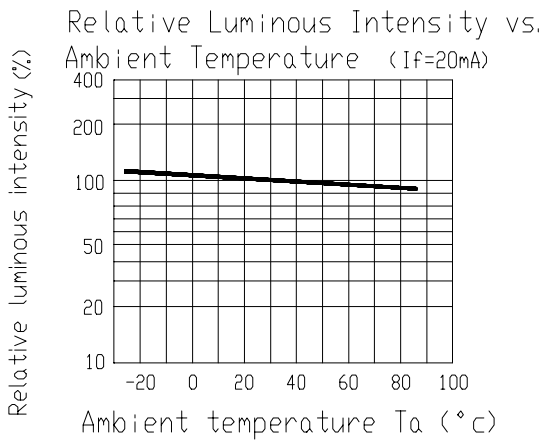
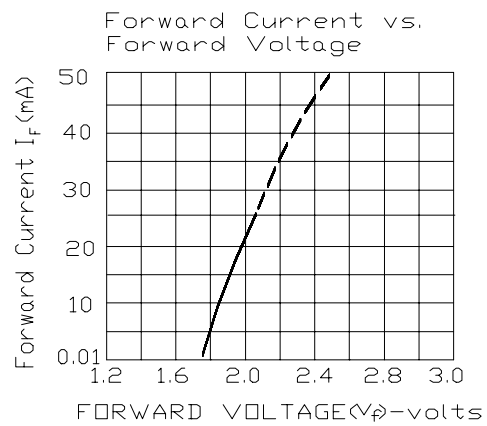
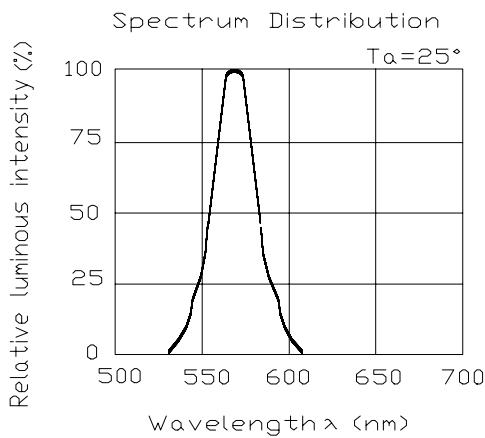



EVERLIGHT ELECTRONICS CO.,LTD.

Device Number : DLE-125-102 REV: 1.0

3.0mm Multi-Color Round Type LED Lamps

MODEL NO : 1259-7SURSYGW/S530-A2 ECN : _____ Page: 5/5

■ Reliability test item and condition

NO	Item	Test Conditions	Test Hours/Cycle	Sample Size	Ac/Re
1	Solder Heat	TEMP : 260°C ± 5 °C	5 SEC	76 Pcs	0/1
2	Temperature Cycle	H : +85°C 30min ∫ 5 min L : -55°C 30min	50 CYCLE	76 Pcs	0/1
3	Thermal Shock	H : +100°C 5min ∫ 10 sec L : -10°C 5min	50 CYCLE	76 Pcs	0/1
4	High Temperature Storage	TEMP : 100°C	1000 HRS	76 Pcs	0/1
5	Low Temperature Storage	TEMP : -55°C	1000 HRS	76 Pcs	0/1
6	DC Operating Life	If = 20 mA	1000 HRS	76 Pcs	0/1
7	High Temperature / High Humidity	85°C/85% RH	1000 HRS	76 Pcs	0/1