

San Ace 60L ^{9CRLA type}

High Static Pressure Long Life Counter Rotating Fan

Features

High Static Pressure

This fan delivers a maximum airflow of 2.1 m³/min and maximum static pressure of 1,400 Pa. The maximum static pressure has increased by approximately 40% compared with our current model.*

Long Service Life

With an expected life of 100,000 hours (about 11 years) of continuous operation, this fan contributes to longer maintenance-free operating periods for devices.

High Energy Efficiency and Low Noise

The PWM control function enables the external control of fan speed, contributing to lowering noise and improving energy efficiency of devices.

* The San Ace 60L 9CRL type 60 x 60 x 76 mm Long Life Counter Rotating Fan (model no.: 9CRL0612P0G001).



60 x 60 x 76 mm



Specifications

The models listed below **have pulse sensors with PWM control function.**

Model no.	Rated voltage [V]	Operating voltage range [V]	PWM duty cycle* [%]	Rated current [A]	Rated input [W]	Rated speed [min ⁻¹]		Max. airflow [m ³ /min] [CFM]		Max. static pressure [Pa] [inchH ₂ O]		SPL [dB(A)]	Operating temperature [°C]	Expected life [h]
						Inlet	Outlet	Inlet	Outlet	[Pa]	[inchH ₂ O]			
9CRLA0612P0G001	12	10.8 to 13.2	100	3.0	36.0	16500	17800	2.1	74.1	1400	5.62	70	-20 to +70	100000/60°C
			20	0.4	4.8	5000	5400	0.64	22.6	128	0.51	43		
9CRLA0612P0G003			100	3.0	36.0	16500	17800	2.1	74.1	1400	5.62	70		
			20	0.4	4.8	5000	5400	0.64	22.6	128	0.51	43		

* PWM frequency: 25 kHz. Fan does not rotate when PWM duty cycle is 0%.

Models with the following sensor specifications are also available as options: **Without sensor** **Lock sensor**

Common Specifications

- Material Frame: Aluminum (Black coating), Impeller: Plastic (Flammability: UL 94V-1)
- Expected life Refer to specifications
(L10 life: 90% survival rate for continuous operation in free air at 60°C, rated voltage)
- Motor protection system Current blocking function and reverse polarity protection
- Dielectric strength 50/60 Hz, 500 VAC, for 1 minute (between lead wire conductors and frame)
- Sound pressure level (SPL) At 1 m away from the air inlet
- Operating temperature Refer to specifications (Non-condensing)
- Storage temperature -30 to +70°C (Non-condensing)
- Lead wire Inlet: ⊕ Red ⊖ Black [Sensor] Yellow [Control] Brown
Outlet: ⊕ Orange ⊖ Gray [Sensor] Purple [Control] White
- Mass Approx. 310 g

Airflow - Static Pressure Characteristics

• PWM duty cycle

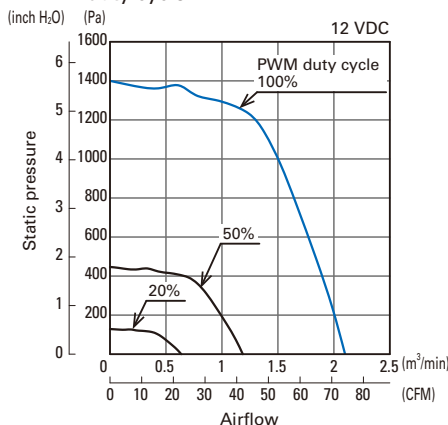

9CRLA0612P0G001
9CRLA0612P0G003

• Operating voltage range

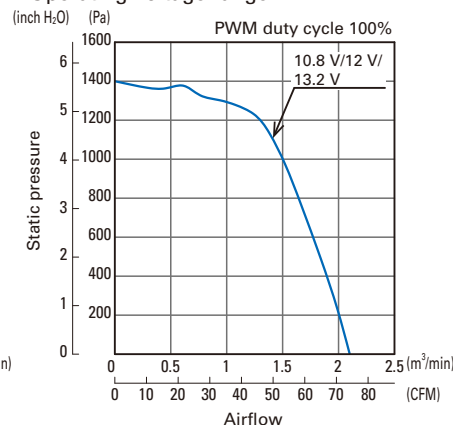

9CRLA0612P0G001
9CRLA0612P0G003

PWM Duty - Speed Characteristics Example

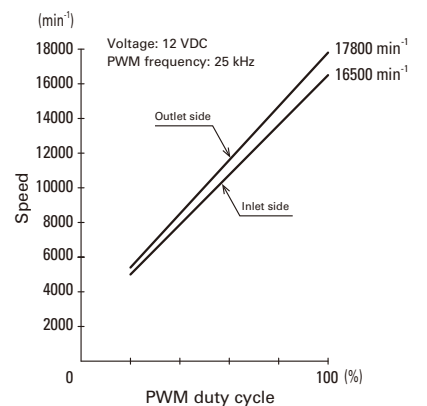

9CRLA0612P0G001
9CRLA0612P0G003

PWM Input Signal Example

Input signal waveform

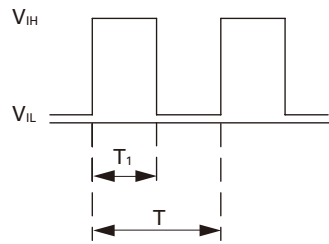

$V_{IH} = 4.75 \text{ to } 5.25 \text{ V}$ $V_{IL} = 0 \text{ to } 0.4 \text{ V}$
 PWM duty cycle (%) = $\frac{T_1}{T} \times 100$ PWM frequency 25 (kHz) = $\frac{1}{T}$
 Current source (I_{source}) = 5 mA max. (when control voltage is 0 V)
 Current sink (I_{sink}) = 5 mA max. (when control voltage is 5.25 V)
 Control terminal voltage = 5.25 V max. (when control terminal is open)

When the control terminal is open,
 fan speed is the same as when PWM duty cycle is 100%.
 Either TTL input, open collector or open drain can be used for
 PWM control input signal.

Example of Connection Schematic

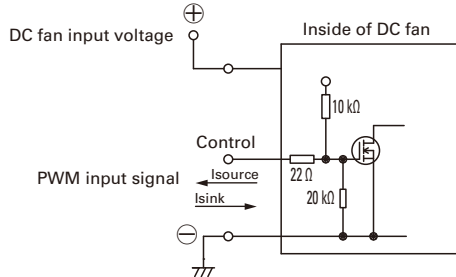

Specifications for Pulse Sensors

Output circuit: Open collector

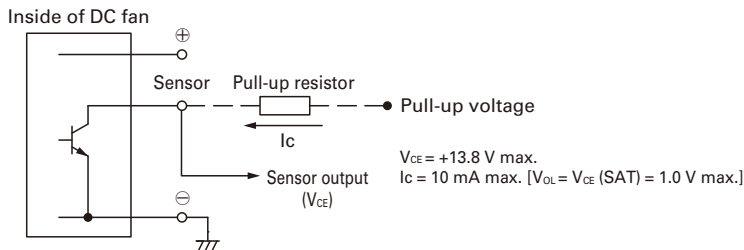

Output waveform (Need pull-up resistor)

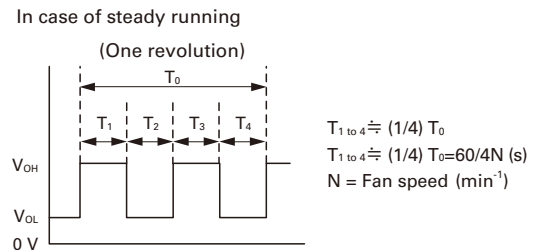

Dimensions (unit: mm)

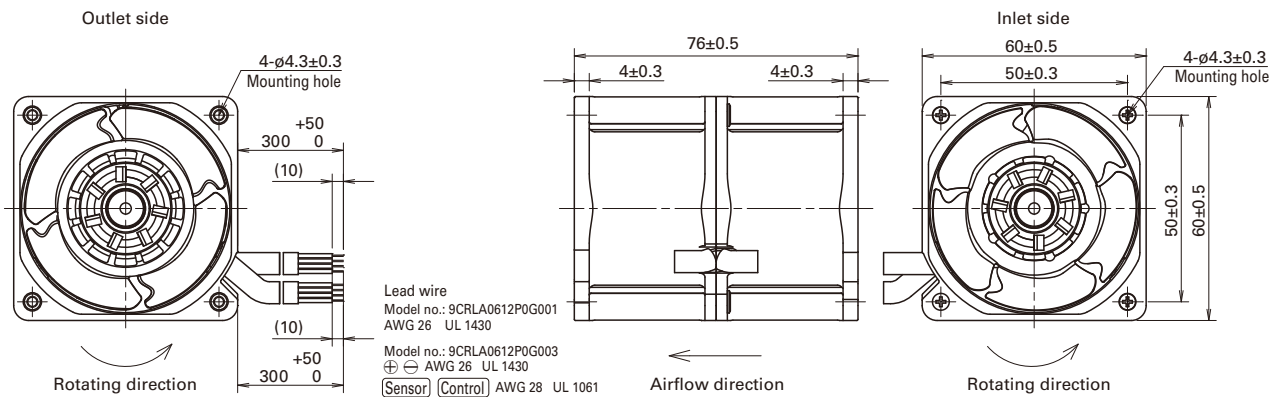

Reference Dimensions of Mounting Holes and Vent Opening (unit: mm)

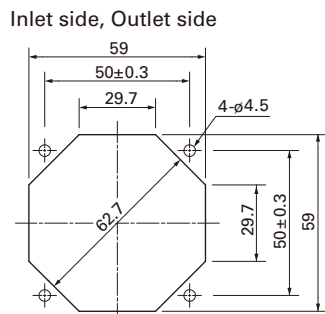

Notice

- Please read the "Safety Precautions" on our website before using the product.
- The products shown in this catalog are subject to Japanese Export Control Law. Diversion contrary to the law of exporting country is prohibited.
- For protecting fan bearings against electrolytic corrosion near strong electromagnetic noise sources, we provide effective countermeasures such as Electrolytic Corrosion Proof Fans and EMC guards. Contact us for details.

SANYO DENKI CO., LTD. 3-33-1, Minami-Otsuka, Toshima-ku, Tokyo 170-8451, Japan TEL: +81 3 5927 1020

<https://www.sanyodenki.com>

The names of companies and/or their products specified in this catalog are the trade names, and/or trademarks and/or registered trademarks of such respective companies. "San Ace" is a trademark of SANYO DENKI CO.,LTD. Specifications are subject to change without notice.

CATALOG No. C1083B002 '18.5