

FOR CIRCUIT SIZES 68 AND 80 ONLY

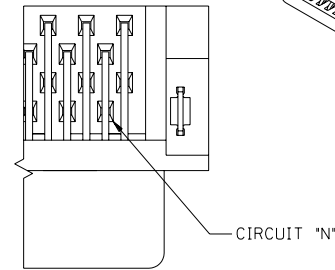

FOR CIRCUIT SIZE 50 ONLY

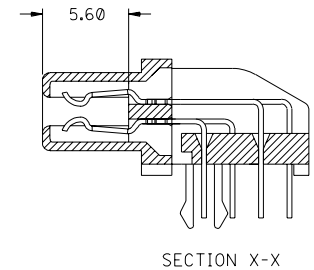
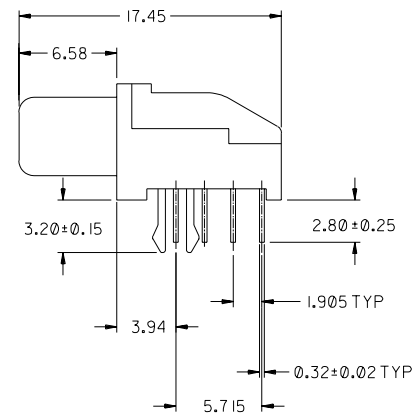
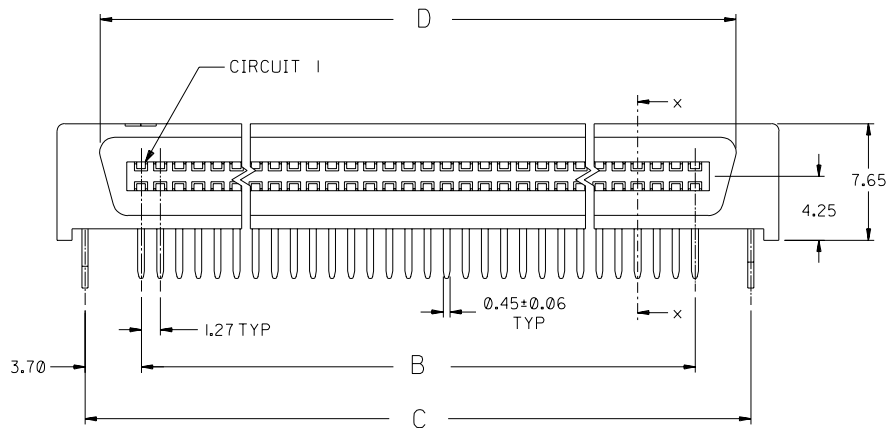
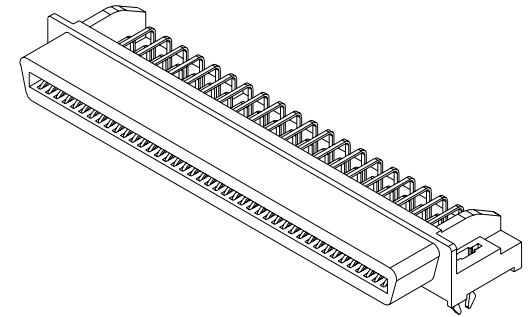

NOTES:

1. MATERIAL: HOUSING -- HIGH TEMP. THERMOPLASTIC, UL94-V0
TERMINALS -- COPPER ALLOY
2. PLATING:
 - 2A 0.76µM MIN. GOLD IN SELECTIVE CONTACT AREA AND 2.54µM MIN. TIN-LEAD IN SOLDER TAIL AREA, BOTH OVER 1.27µM MIN. NICKEL.
 - 2B 0.75µM MIN. GOLD IN SELECTIVE CONTACT AREA AND 2.5µM MIN. TIN IN SOLDER TAIL AREA, BOTH OVER 1.27µM MIN. NICKEL.
3. ASSEMBLY MATES WITH MOLEX P/N 71661-****.
4. RECOMMENDED P.C. BOARD THICKNESS IS 1.60MM.
5. PRODUCT SPEC. NO.: PS-87552-006
6. SEE TABLE ON SHEET 2 FOR ASSEMBLY PART NUMBERS.

ADD TIN PLATED OPTION	EC NO. S2004-0161	QUALITY SYMBOLS	GENERAL TOLERANCES: (UNLESS SPECIFIED)		SCALE 3:1	DESIGN UNITS <input checked="" type="checkbox"/> mm <input type="checkbox"/> INCH	THIRD ANGLE PROJECTION <input checked="" type="checkbox"/> <input type="checkbox"/>		DIMENSIONS: <input type="checkbox"/> mm <input type="checkbox"/> INCH <input type="checkbox"/> mm <input checked="" type="checkbox"/> ONLY		2	GI
	DRWN: KSEE 030930	MAJOR $\nabla = 0$	4 PLACES $\pm 0. -$	$\pm. -$	DRAWN BY & DATE D SOH 970401		TITLE: ASSY, 1.27mm PITCH, R/A EBBI RECEPT		1	GI	SHT	REV
	CHK: KCLING 030930	CRITICAL $\nabla = 0$	3 PLACES $\pm 0. -$	$\pm. -$	CHECKED BY & DATE KC LING 970506		APPROVED BY & DATE SK TOH 970508		MOLEX MOLEX INCORPORATED		REVISE ON CAD ONLY	
	APPR: SKTOH 030930	DESCRIPTION	2 PLACES ± 0.30	$\pm. -$	CAD FILENAME S87552AA.S01		MATERIAL NO. SEE CHART	DRAWING NO. SD-87552-007	SHEET NO. 1 OF 2			
REV			1 PLACE $\pm 0. -$	$\pm. -$	ANGULAR: $\pm 3^\circ$		THIS DRAWING CONTAINS INFORMATION THAT IS PROPRIETARY TO MOLEX INCORPORATED AND SHOULD NOT BE USED WITHOUT WRITTEN PERMISSION.		SIZE A3			

8	7	6	5	4	3	2	1
D	C	B	A	CKT SIZE	ASSEMBLY PART NUMBER (TIN/LEAD)	ASSEMBLY PART NUMBER (TIN)	
36.02	37.88	30.48	41.70	50	87552-0501	87552-0507	
47.45	49.31	41.91	53.13	68	87552-0681	87552-0687	
55.07	56.93	49.53	60.75	80	87552-0801	87552-0807	

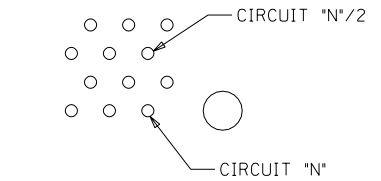
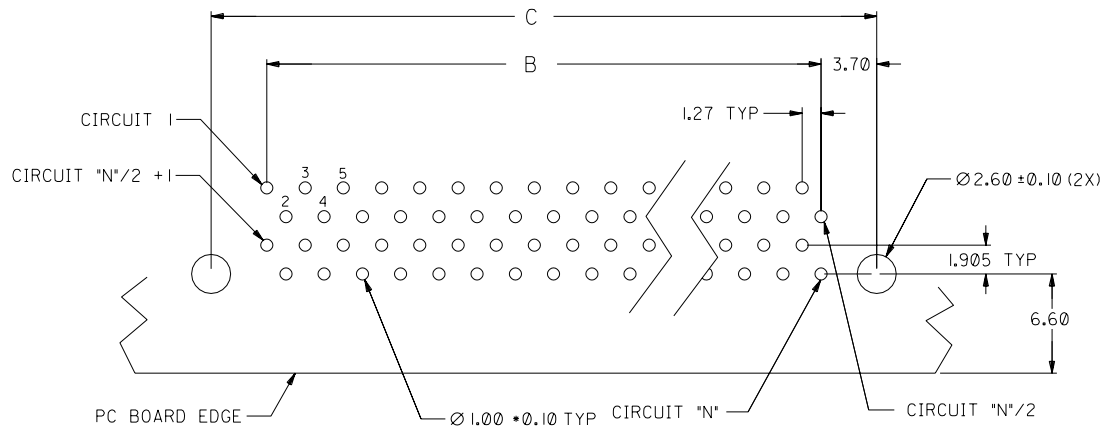

RECOMMENDED PC BOARD LAYOUT COMPONENT SIDE (FOR CIRCUIT SIZES 68 AND 80 ONLY)

(FOR CIRCUIT SIZE 50 ONLY)

ADD TIN PLATED OPTION EC NO. S2004-0161 DRWN: KSEE 030930 CHK: KCLING 030930 APPR: SKTOH 030930	QUALITY SYMBOLS MAJOR ▼ = 0 CRITICAL ▽ = 0	GENERAL TOLERANCES: (UNLESS SPECIFIED)		SCALE 3:1	DESIGN UNITS <input checked="" type="checkbox"/> mm <input type="checkbox"/> INCH	THIRD ANGLE PROJECTION <input checked="" type="checkbox"/>	DIMENSIONS: <input type="checkbox"/> mm <input type="checkbox"/> INCH <input checked="" type="checkbox"/> mm ONLY	SHT	REV	
		4 PLACES	±0. -	±. -	DRAWN BY & DATE D SOH 970401		TITLE: ASSY, 1.27mm PITCH, R/A EBBI RECEIPT			
		3 PLACES	±0. -	±. -	CHECKED BY & DATE KC LING 970506					
		2 PLACES	±0.30	±. -	APPROVED BY & DATE SK TOH 970508		MOLEX INCORPORATED			
1 PLACE	±0. -	±. -	ANGULAR: ± 3°		CAD FILENAME S87552AA.S01	MATERIAL NO. SEE CHART	DRAWING NO. SD-87552-007	SHEET NO. 2 OF 2	SIZE A3	
REV	DESCRIPTION	THIS DRAWING CONTAINS INFORMATION THAT IS PROPRIETARY TO MOLEX INCORPORATED AND SHOULD NOT BE USED WITHOUT WRITTEN PERMISSION.								