

## Precision Sine Wave Reference

### FEATURES

- Very High Accuracy: +7.071 Vrms  $\pm$ 0.5%
- Extremely Low Drift: 20 ppm/ $^{\circ}$ C (-55 $^{\circ}$ C to +125 $^{\circ}$ C)
- Excellent Stability: 10 ppm/1000 Hrs. Typical
- Low Distortion: 0.1% THD @ F = 3300 Hz
- Hermetic 14-pin Ceramic DIP
- Military Processing Option

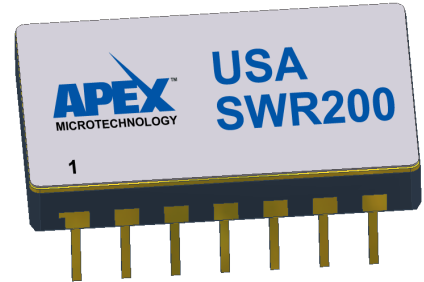

### APPLICATIONS

- Transducer Excitation
- High Resolution Servo Systems
- High Precision Test and Measurement Instruments
- AC Voltage Standard
- $L_{VDT}$  or  $R_{VDT}$  Reference
- Multiplying D/A Reference

### DESCRIPTION

SWR200 is a Precision Sine Wave Reference providing an ultra stable sine wave output of +7.071 V at  $\pm$ 0.5% initial accuracy and temperature coefficient as low as 20 ppm/ $^{\circ}$ C over the full military temperature range. The extreme accuracy is made possible by a chopper-based AGC circuit. The temperature characteristic of the chopper circuit compensates the typical nonlinearity of the internal DC zener reference, resulting in a nearly linear amplitude-temperature characteristic. Frequency of the SWR200 is programmable with two external capacitors.

The SWR200 is available in a 14-pin bottom braze package. They are hermetically sealed and “M” versions are screened for high reliability and quality.

SWR200 is well suited for any application requiring a stable sine wave source. The SWR200 can be used as a reference source in precision sensing systems based on  $L_{VDT}$  or  $R_{VDT}$  position sensors. A programmable AC reference can be constructed using the SWR200 as a reference for a high accuracy multiplying Digital to Analog Converter.

### SELECTION GUIDE

Type	Output (TYP)	Temperature Operating Range	Package
SWR200C	+7.071V	-25 $^{\circ}$ C to +85 $^{\circ}$ C	DIP
SWR200M	+7.071V	-55 $^{\circ}$ C to +125 $^{\circ}$ C	DIP

TYPICAL CONNECTION

Figure 1: Typical Connection

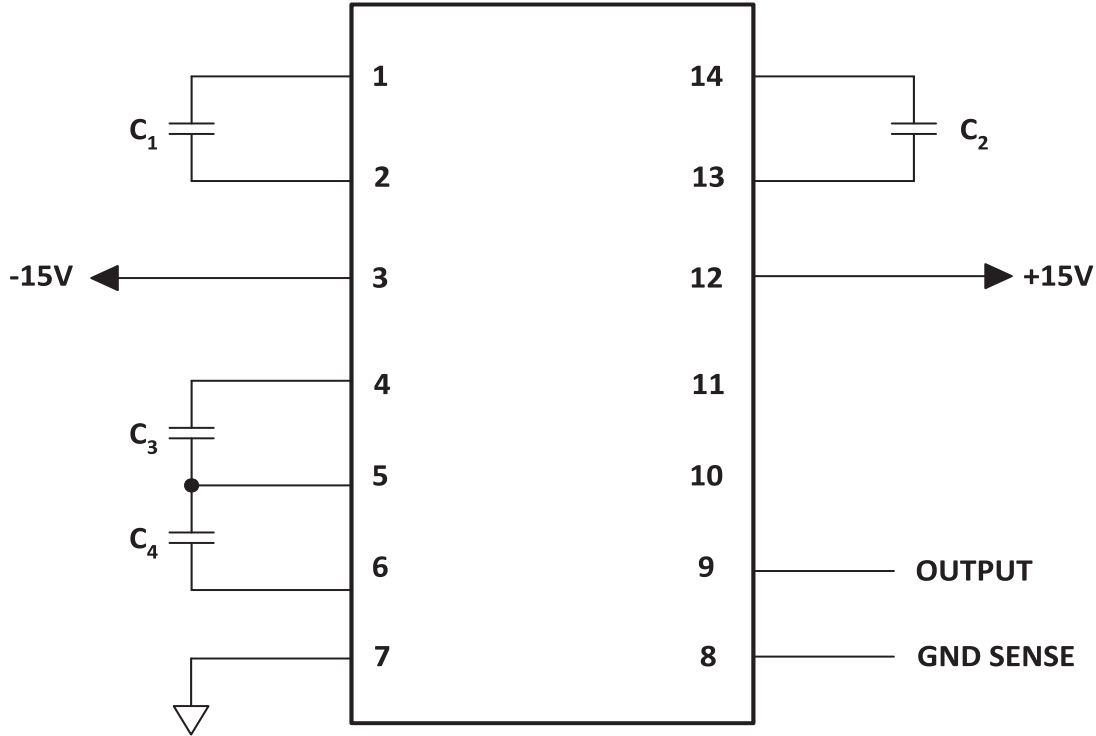

PIN DESCRIPTIONS

Pin Number	Name	Description
1, 2	C1	Frequency selection capacitor connection C <sub>1</sub> . See applicable selection.
3	-V <sub>PS</sub>	The negative supply voltage connection.
7	GND	Ground.
8	REF_GND	Provided for accurate ground sensing. Internally connected to GND.
9	OUT	The output.
12	+V <sub>PS</sub>	The positive supply voltage connection.
13, 14	C2	Frequency selection capacitor connection C <sub>2</sub> . See applicable selection.
4	C3	Optional frequency range expansion. Connect C <sub>3</sub> between pins 4 and 5 of value approximately 2 x C <sub>1</sub> .
5	Extended Range Connection	Optional frequency range expansion. See Typical Application drawing for connection.
6	C4	Optional frequency range expansion. Connect C <sub>4</sub> between pins 5 and 6 of value approximately 20 x C <sub>2</sub> .
10, 11	NC	No connection.

## SPECIFICATIONS

$V_{PS} = \pm 15\text{ V}$ ,  $T = 25^\circ\text{C}$ ,  $R_L = 10\text{ k}\Omega$  unless otherwise noted.

### ABSOLUTE MAXIMUM RATINGS

Parameter	SWR200C			SWR200M			Units
	Min	Typ	Max	Min	Typ	Max	
Power Supply	$\pm 13.5$	$\pm 15$	$\pm 22$	*	*	*	V
Operating Temperature	-25		+85	-55		+125	$^\circ\text{C}$
Storage Temperature	-65		+85	*		*	$^\circ\text{C}$
Short Circuit Protection	Continuous			*			

### ELECTRICAL SPECIFICATIONS

Parameter <sup>1</sup>	SWR200C			SWR200M			Units
	Min	Typ	Max	Min	Typ	Max	
Output Voltage		7.071			*		V
Initial Error			$\pm 0.5$			*	%
Warmup Drift		100			*		$\mu\text{V}$
DC Offset			3			*	mV
DC Offset Over Temp.		3	18		*	*	$\mu\text{V}/^\circ\text{C}$
$T_{\text{MIN}} - T_{\text{MAX}}^2$			20.0			30.0	ppm/ $^\circ\text{C}$
Long-Term Stability		10			*		ppm/ $^\circ\text{C}$
Output Current	$\pm 10$			*			mA
Line Regulation		10			*		ppm/V
Load Regulation		3			*		ppm/mA
Power Supply Current, +PS <sup>3</sup>		10.5	13		*	*	mA
Power Supply Current, -PS <sup>3</sup>		9.5	13		*	*	mA
Power Supply Current, Distortion <sup>3</sup>			0.5			*	%
Normalized Error	0.98	1	1.02	*	*	*	Hz
Range (f) $(f) = \frac{10^{-5}}{\sqrt{C_1 C_2}}$	400		10 k	*		*	Hz
$\frac{\Delta f}{f}$ vs. Temperature			15			*	ppm/ $^\circ\text{C}$

1. Pin 8 is internally connected to Pin 7 and can be used as Ref. GND.
2. Using the Box Method, the specified value is the maximum deviation from the output voltage at  $25^\circ\text{C}$  over the specified operating temperature range.
3. The specified values are unloaded.

**Notes:** \* Same as C Models

TYPICAL PERFORMANCE GRAPHS

Figure 2:  $V_{OUT}$  vs. Temperature (SWR200C)

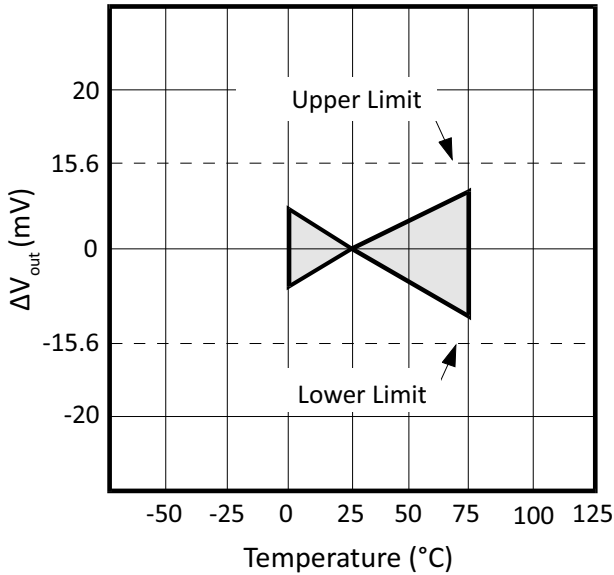

Figure 3:  $V_{OUT}$  vs. Temperature (SWR200M)

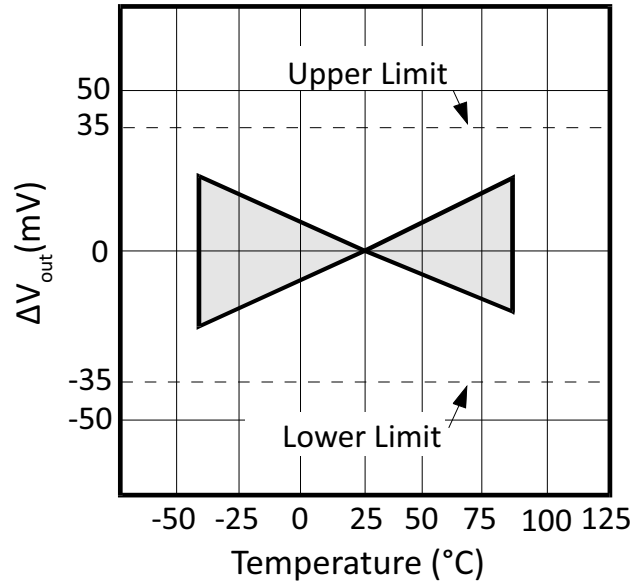

Figure 4: %  $\Delta$  Freq. vs. Temperature (SWR200C)

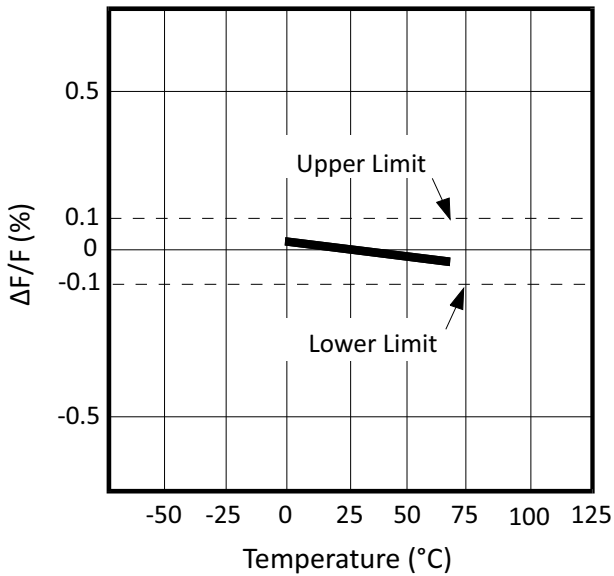
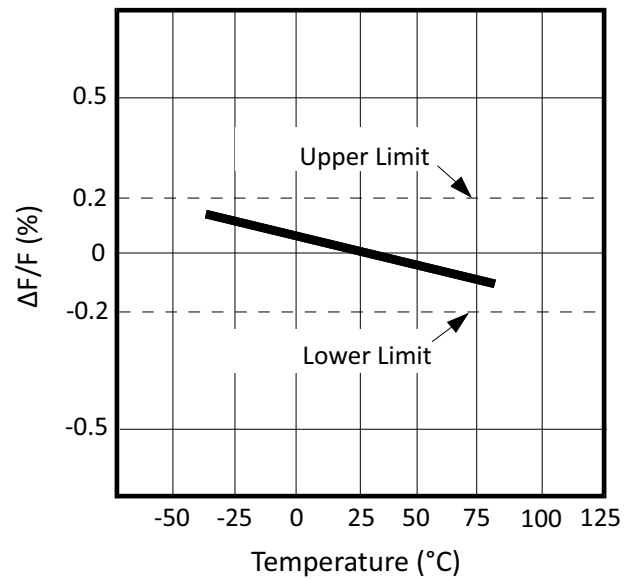
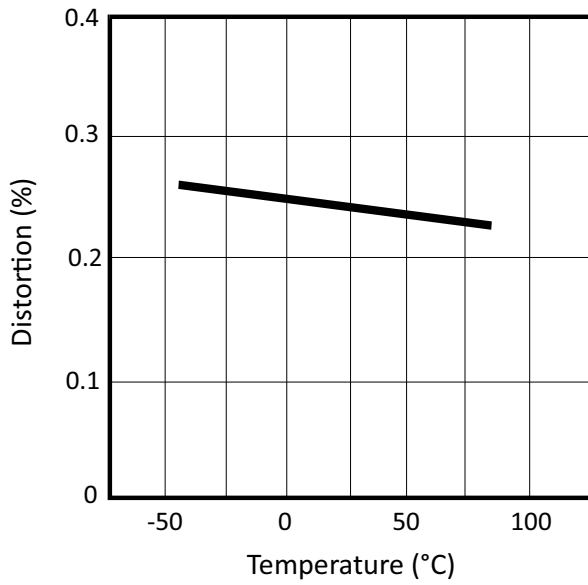

Figure 5: %  $\Delta$  Freq. vs. Temperature (SWR200M)



**Figure 6: Distortion vs. Temperature**



**Figure 7: Distortion vs. Frequency**

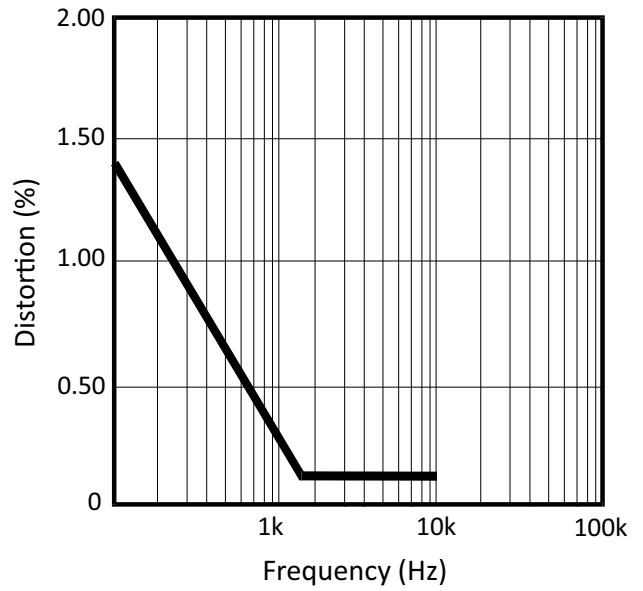

**Figure 8: Normalized Distortion vs. C2/C1**

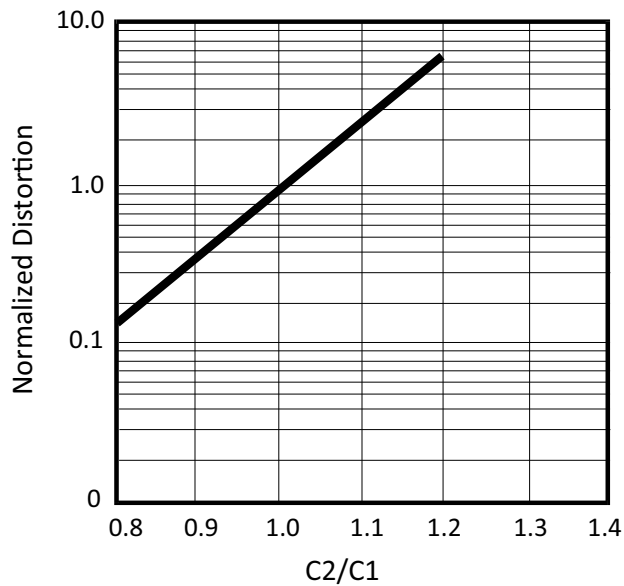

**Figure 9: Power Supply Current vs. Temperature**

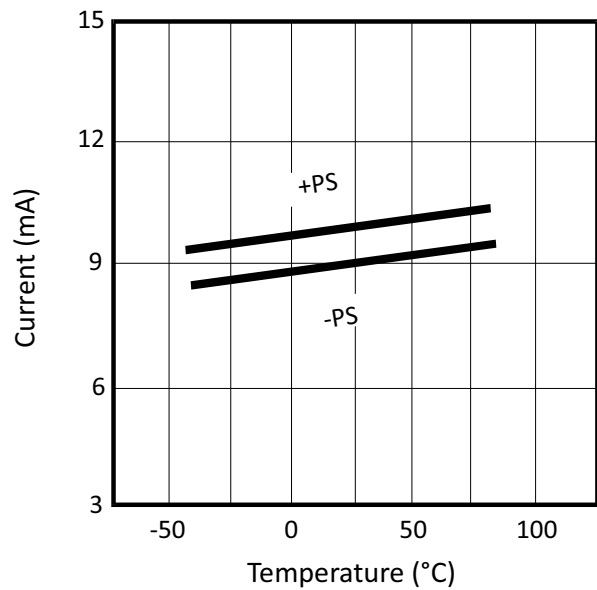

Figure 10: Case Temp. Rise Above Ambient vs. Output Current

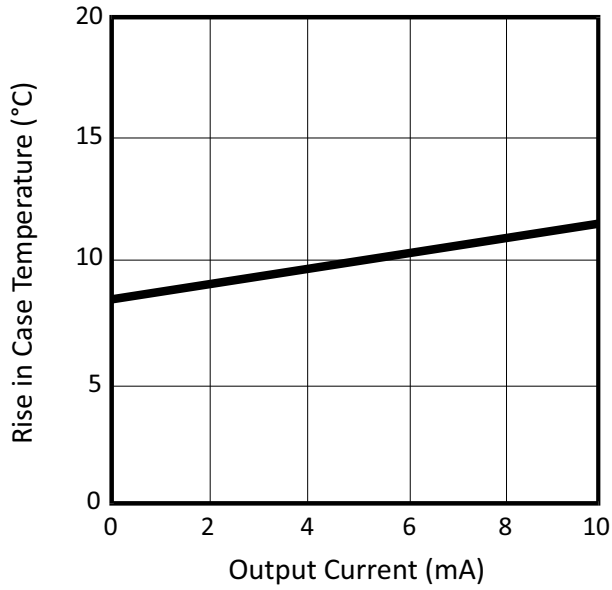
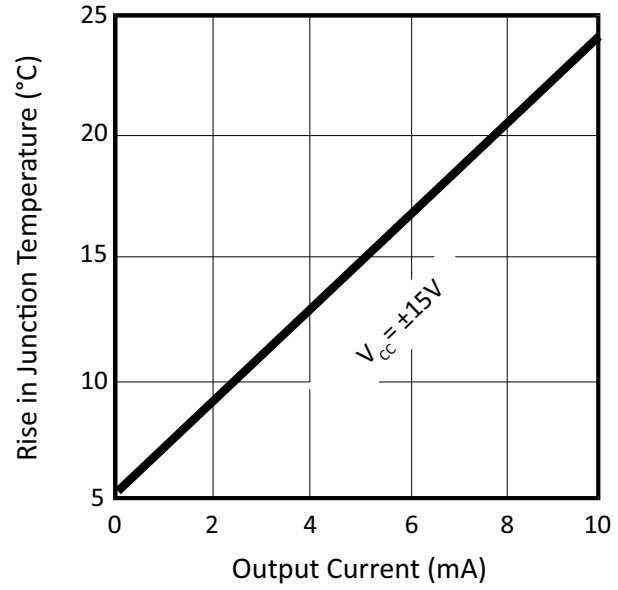
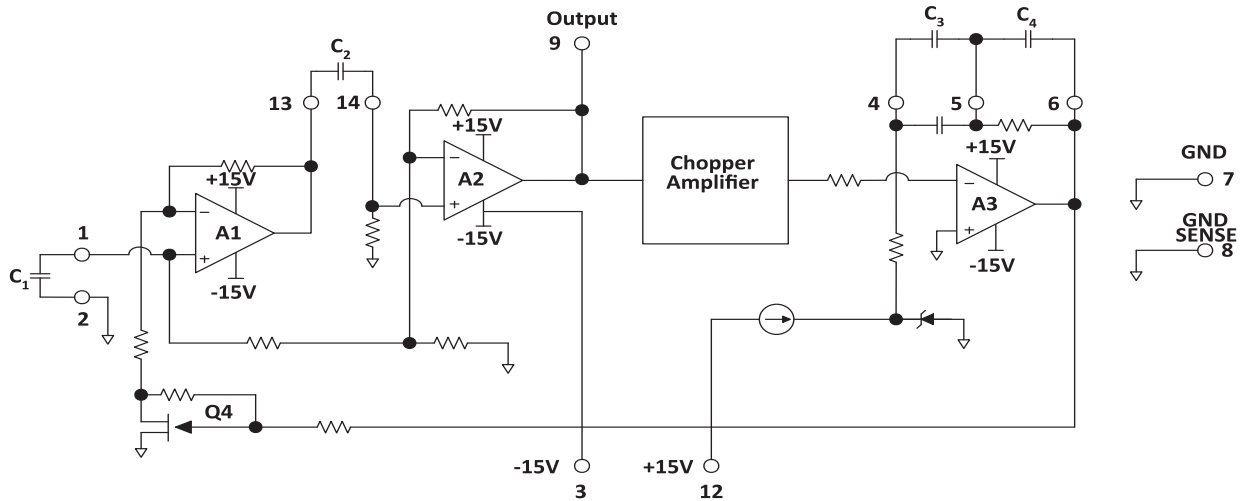

Figure 11: Junction Temp. Rise Above Case Temp. vs. Output Current



**BLOCK DIAGRAM**

Figure 12: Block Diagram



**THEORY OF OPERATION**

The following refers to the schematic in Figure 12. A1 and A2 are connected as a phase-shift oscillator circuit with the frequency set by the external capacitors C1 and C2. Q4 is included in the feedback loop of A1 as a gain control element.

The oscillator output is fed to the chopper amplifier which develops an absolute value representation of the oscillator output. The chopper output is compared to a precision DC reference in integrator amplifier A3. This DC error signal is used to control the gain setting FET Q4.

As in all precision zener based DC references, the drift of the zener becomes nonlinear at temperature extremes. The chopper amplifier drift characteristic is complementary to this nonlinearity and compensates for the reference drift.

**APPLICATION INFORMATION**

Figure 2 shows the connections for the SWR200 including the two frequency setting capacitors. The frequency is:

$$f = \frac{10^{-5}}{\sqrt{C_1 C_2}}$$

The frequency stability is directly related to the stability of the capacitors, therefore stable capacitors like NPO ceramic, polycarbonate or polypropylene film should be used. Specified device operation relies on the tight matching of capacitors C1 and C2. The capacitor mismatch must not exceed 10% over the entire operating temperature range. The recommended capacitor tolerance is 5% or less to ensure specified electrical performance.

Two separate ground pins are provided for accurate ground sensing. This minimizes errors due to drops in the ground pin which can become a significant source of error in sockets.

The offset of the SWR200 is fully specified for initial offset and drift and is low enough that it can normally be neglected. In applications which are especially sensitive to offset the output can be AC coupled. Proper capacitor sizing and high impedance sensing will minimize errors due to capacitive coupling.

## PIN CONFIGURATION

Figure 13: Pin Configuration

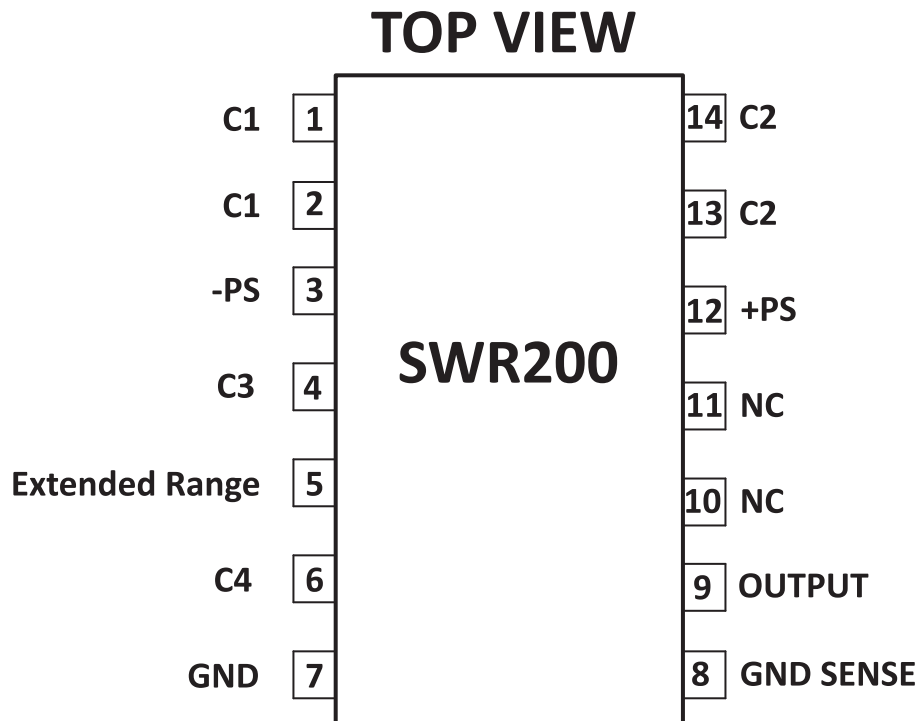



## EXTENDED FREQUENCY RANGE

The SWR200 with two external frequency setting capacitors is fully specified for operation from 400 Hz to 10 kHz. At lower frequencies, the limitations occurs in the AGC circuit that provides the high amplitude stability of the SWR200. There is also a slight increase in distortion from 1500 Hz down to 400 Hz, which continues as frequency decreases.

Two external capacitors (C3 and C4 in figure 14) can increase the time constant of the AGC circuit allowing for use at lower frequencies. This increase in time constant comes with the trade-off of a longer settling time from power on.

The value for the lower frequency AGC capacitors is given by the following schematic and formula. To predict AGC settling requirements, use the following formula:

$$\frac{300}{F} = T$$

Where: F is frequency in Hertz

T is time in seconds

Use of the external AGC capacitors can also have an effect on distortion. The SWR200 data sheet shows an increasing distortion with decreasing frequency starting at 1500 Hz. This effect is entirely due to time constants within the AGC circuitry which are correctable with the inclusion of C3 and C4.

Among the application possibilities provided by frequency range enhancement of the SWR200, mention should be made of the use of the SWR200 as an ultra-precise 60 Hz source. This can have wide application in 60 Hz testing and generation.

**Figure 14: Extended Frequency External Connections**

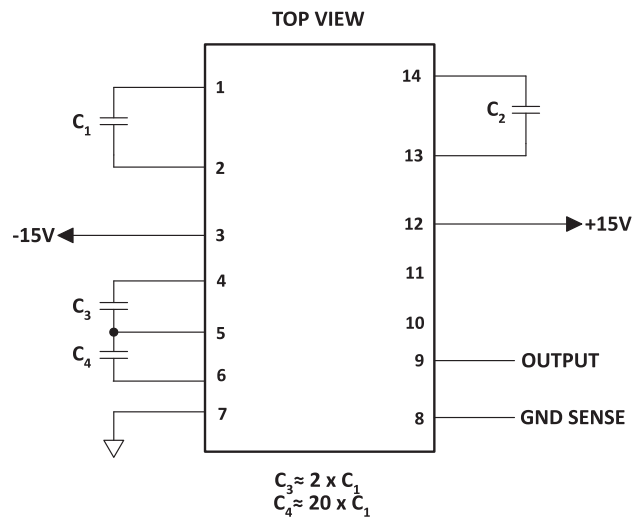

## PACKAGE OPTIONS

Part Number	Apex Package Style	Description
SWR200C	HC	Hermetic 14-pin Ceramic DIP
SWR200M	HC	Hermetic 14-pin Ceramic DIP

### PACKAGE STYLE HC

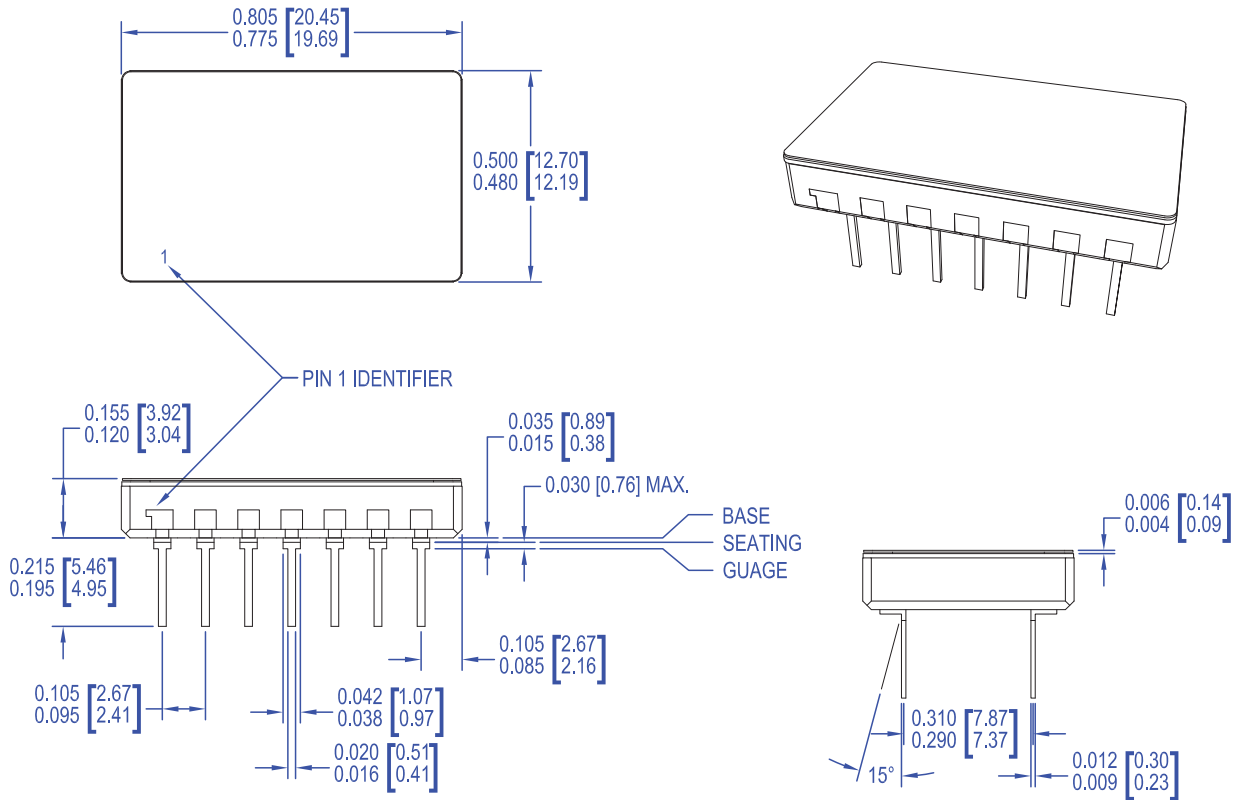

#### NOTES:

1. Dimensions are inches & [millimeters].
2. Bracketed alternate units are for reference only.
3. Pins: Phosphor bronze, Gold over Nickel plated.
4. Material: Alumina Ceramic substrate and cover.
5. Cover: Electroless Nickel plated.
6. Package weight: 0.092 oz. [2.605 g].

---

## **NEED TECHNICAL HELP? CONTACT APEX SUPPORT!**

For all Apex Microtechnology product questions and inquiries, call toll free 800-546-2739 in North America. For inquiries via email, please contact [apex.support@apexanalog.com](mailto:apex.support@apexanalog.com). International customers can also request support by contacting their local Apex Microtechnology Sales Representative. To find the one nearest to you, go to [www.apexanalog.com](http://www.apexanalog.com)

---

### IMPORTANT NOTICE

Apex Microtechnology, Inc. has made every effort to insure the accuracy of the content contained in this document. However, the information is subject to change without notice and is provided "AS IS" without warranty of any kind (expressed or implied). Apex Microtechnology reserves the right to make changes without further notice to any specifications or products mentioned herein to improve reliability. This document is the property of Apex Microtechnology and by furnishing this information, Apex Microtechnology grants no license, expressed or implied under any patents, mask work rights, copyrights, trademarks, trade secrets or other intellectual property rights. Apex Microtechnology owns the copyrights associated with the information contained herein and gives consent for copies to be made of the information only for use within your organization with respect to Apex Microtechnology integrated circuits or other products of Apex Microtechnology. This consent does not extend to other copying such as copying for general distribution, advertising or promotional purposes, or for creating any work for resale.

APEX MICROTECHNOLOGY PRODUCTS ARE NOT DESIGNED, AUTHORIZED OR WARRANTED TO BE SUITABLE FOR USE IN PRODUCTS USED FOR LIFE SUPPORT, AUTOMOTIVE SAFETY, SECURITY DEVICES, OR OTHER CRITICAL APPLICATIONS. PRODUCTS IN SUCH APPLICATIONS ARE UNDERSTOOD TO BE FULLY AT THE CUSTOMER OR THE CUSTOMER'S RISK.

Apex Microtechnology, Apex and Apex Precision Power are trademarks of Apex Microtechnology, Inc. All other corporate names noted herein may be trademarks of their respective holders.