

**Panasonic**  
ideas for life

**HIGH VOLTAGE AND  
CURRENT CUT-OFF  
CAPACITY IN A  
COMPACT PACKAGE**

**EP RELAYS**

**FEATURES**

150A 2 Form A



150A 1 Form A



60A



PC board type



TM type



**• Control of large voltages and currents**

The relays have a sealed construction that is filled with a hydrogen gas compound, and use a permanent magnet to establish a magnetic path for the arc. This allows them to switch high-level DC voltages of up to 400V DC.

**• Compact size and light weight**

The capsule contact construction is filled with a gas that has excellent thermal dissipation and insulation characteristics. Because of this we have been able to reduce the contact gap to one tenth that of conventional relays, and produce a compact and light design.

**• No arc space is required: size including arc space 1/9 (compared to conventional contactors)**

The arc is not exposed to the outside, therefore, no arc space is not required.

**• Safety construction**

The arc is not exposed, therefore, the contactor is explosion proof and intrinsically safe.

**• Quiet: operation noise 1/4 (compared to conventional contactors).**

Along with the above-mentioned miniaturization, the operation noise has been reduced to 70dB, and, in addition, the operation noise remains unchanged when a current of 1000A or more is interrupted.

**• High contact reliability**

The contact part is hermetically sealed, hence the contact resistance remains stable regardless of the ambient conditions.

**• Mounting direction is not specified**

The weight of the movable parts is light, and also the restoring force is large, hence the contactor is relatively unaffected by gravity.

**• Line-up of indicator types (150A Type only)**

1 Form A and 1 Form B types with indicators for detecting welding of the main contacts are available.

**• Line-up of PC board type and TM type (10A type only)**

**• 12 and 24V DC coil voltage types are available.**

**• Screw terminal blocks for easy wiring.**

**TYPICAL APPLICATIONS**

- AGV (Automatic guided vehicle) (motor control)
- Electrical discharge machine (capacitor charge and discharge control)
- Inverter control (Error cut-off circuit)
- UPS (uninterruptible power supplies)
- Solar power generation systems (battery control)
- Unmanned transport carts
- Battery inspection and testing equipment
- Welding equipment
- Elevator (Brake control)

**ORDERING INFORMATION**

Ex. A EP 1 5 0 12

Product Name	Contact arrangement	Contact rating	Indicator contact arrangement	Coil voltage
EP	1: 1 Form A 2: 2 Form A 3: 1 Form A PC board type (10A type only) 5: 1 Form A TM type (10A type only)	1: 10A 5: 150A 6: 60A	0: without indicator contact 1: a contact (150A type only) 3: b contact (150A type only)	12: 12V DC 24: 24V DC 48: 48V DC (10A type only) X0: 100V DC (10A type only)

## TYPES AND COIL DATA (at 20°C 68°F)

Part No.	Coil voltage, V DC	Pick-up voltage, V DC (max.) (at 20°C)	Drop-out voltage, V DC (min.) (at 20°C)	Nominal coil current, mA ( $\pm 10\%$ ) (at 20°C)	Operating power, W (12 V DC, at 20°C)	Max. allowable voltage, V DC
AEP25012*	12 V DC	9 V DC	1 V DC	2.8 A (at peak)*	35W (Inrush, approx. 0.1S) 5W (Stable)	16 V DC
AEP15012*				0.415 A	Max. 5W	
AEP16012						
AEP25024*	24 V DC	18 V DC	2 V DC	1.9 A (at peak)*	35W (Inrush, approx. 0.1S) Max. 5W (1 Form A) Max. 6W (2 Form A)	32 V DC
AEP15024*				2.2 A (at peak)*		
AEP16024				0.208 A	Max. 5W	
AEP31012	12 V DC	9 V DC	0.75 V DC	0.103 A (at peak)*	Approx. 1.4W	14 V DC
AEP31024	24 V DC	18 V DC	1.50 V DC	0.052 A (at peak)*		28 V DC
AEP31048	48 V DC	36 V DC	3.98 V DC	0.026 A (at peak)*		56 V DC
AEP310X0	100 V DC	75 V DC	8.3 V DC	0.012 A (at peak)*		116 V DC
AEP51012	12 V DC	9 V DC	0.75 V DC	0.103 A (at peak)*	Approx. 1.4W	14 V DC
AEP51024	24 V DC	18 V DC	1.50 V DC	0.052 A (at peak)*		28 V DC
AEP51048	48 V DC	36 V DC	3.98 V DC	0.026 A (at peak)*		56 V DC
AEP510X0	100 V DC	75 V DC	8.3 V DC	0.012 A (at peak)*		116 V DC

Note: \*Same coil data as Indicator type.

When using a DC power supply use one that has a leeway of at least 150% current capacity.

## Packing quantity

Types	Inner	Outer
150A 2 Form A	1pc.	5pcs.
150A 1 Form A	1pc.	10pcs.
60A 1 Form A	1pc.	20pcs.
10A 1 Form A	25pcs.	100pcs.

## SPARE PARTS

Installing parts	Part No.	Packing Quantity
M8 nut with washer for 150A type	AEV801	2pcs.
M5 screw for 60A type	AEV802	2pcs.
M4 screw for 30A type	AEV803	2pcs.
Bus bar for 60A type	AEV804	1pc.

## SPECIFICATIONS

### Contact

Type		150A type	60A type	10A type
Arrangement		1 Form A, 2 Form A	1 Form A	1 Form A
Rating	Nominal switching capacity (resistive load)	150A 400V DC 150A 277V AC	60A 400V DC 60A 277V AC	10A 400V DC
	Short term current	300A (10min) (harness wire: 40mm <sup>2</sup> )	120A (15min) (harness wire: 15mm <sup>2</sup> )	15A (2min), 30A (30s)
	Max. cut-off current	2,500A 300V DC (3 cycles) <sup>#1</sup>	600A 300V DC (5 cycles)	—
	Overload opening/closing rating	600A 300V DC (Min. 25 cycles)	180A 400V DC (Min. 100 cycles) <sup>#2</sup>	30A 400V DC (Min. 50 cycles)
	Reverse cut-off current	-300A 200V DC (Min. 25 cycles)	-60A 200V DC (Min. 1,000 cycles) <sup>#2</sup>	-10A 200V DC (Min. 2.5×10 <sup>3</sup> cycles)
	Contact voltage drop (Max.)	0.1V (When current [is 150A per 1] contact set)	0.1V (When current [is 60A per 1] contact set)	0.5V (When current [is 10A per 1] contact set)
Nominal operating power		35W (Inrush, approx 0.1s) 5W (Stable)	Max. 5W	—
Expected life (min. operations)	Mechanical	1 Form A: 10 <sup>5</sup> 2 Form A: 5 × 10 <sup>4</sup>	2 × 10 <sup>5</sup>	10 <sup>5</sup>
	Electrical	3 × 10 <sup>3</sup> 150A 400V DC (L/R ≤ 1ms)	3 × 10 <sup>3</sup> 60A 400V DC (L/R ≤ 1ms <sup>#2</sup> )	7.5 × 10 <sup>4</sup> 10A 400V DC (L/R ≤ 1ms <sup>#2</sup> )

### Notes:

Same specifications as the 12 V type.

#1 Condition: Nominal switching 100cycles, each cut off 2,500A

#2 Conditions: Varistor used for coil surge absorption. Note: if a diode is used the life will be lower.

## Characteristics

Initial insulation resistance		Min. 100 MΩ (at 500 V DC)*1
Initial breakdown voltage	Between open contacts	AC 2,500 Vrms for 1 min.*2
	Between contact and coil	AC 2,500 Vrms for 1 min.*2
Operate time (at 20°C) (at nominal voltage)		Max. 50ms*3
Reset time (without diode) (at 20°C) (at nominal voltage)		Max. 30ms*4
Shock resistance	Functional	Min. 196 m/s <sup>2</sup> {20 G}*5
	Destructive	Min. 490 m/s <sup>2</sup> {50 G}*6
Vibration resistance	Functional	43 m/s <sup>2</sup> {4.4 G} 10 to 200Hz*7
	Destructive	43 m/s <sup>2</sup> {4.4 G} 10 to 200 Hz*8
Conditions for operation, transport and storage (Not freezing and condensing at low temperature)	Ambient temperature	-40°C to +80°C*9 -40°F to +176°F
	Humidity	5 to 85% R.H.
Unit weight		150 A 1 Form A: 600 g 21.16oz 150 A 2 Form A: 1,100 g 38.80oz 60 A: 340 g 12.00oz 10 A: 80 g 2.820oz

## Remarks

\*1 Measurement at same location as "Initial breakdown voltage" section.

\*2 Detection current: 10mA.

\*3 Nominal voltage applied to the coil, excluding bounce time.

\*4 Nominal voltage applied to the coil.

\*5 Half-wave pulse of sine wave: 11 ms; detection time: 10μs.

\*6 Half-wave pulse of sine wave: 6 ms.

\*7 Detection time: 10 μs.

\*8 3 directions, each 4 hours.

\*9 Storage: Max. 85°C 185°F.

## Indicator ratings

Arrangement	1 Form A	1 Form B
Material		Gold-clad
Rating (resistive load)		0.1 A 30 V DC
Contact resistance		Max. 100 mΩ

Note: Indicator type is only available for the 150 A type.

## DIMENSIONS

mm inch

### 150A 2 Form A

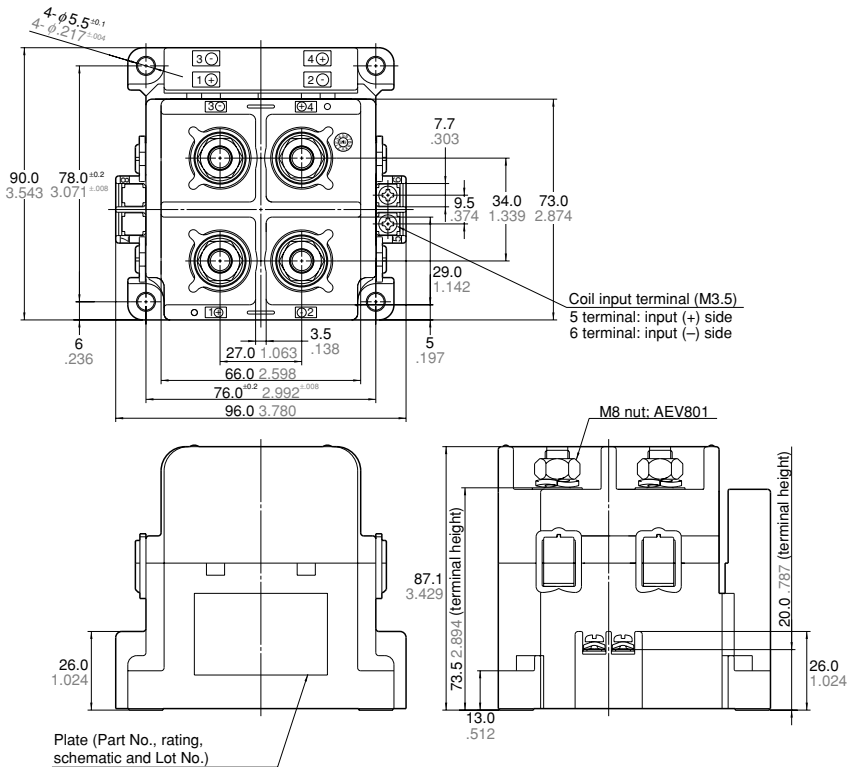

### Schematic (TOP VIEW)

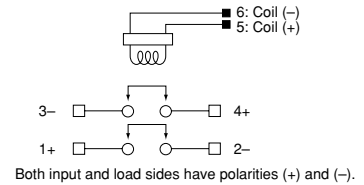

### Mounting dimensions

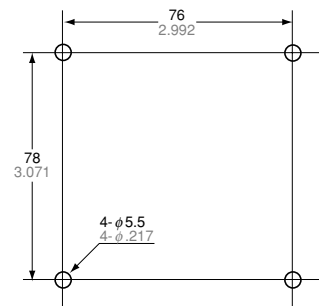

## General tolerance:

less than 10 .394 ±0.3 ±0.12

10 .394 to 50 1.969 ±0.6 ±0.24

more than 50 1.969 ±1.0 ±0.39

150A 2 Form A (Indicator Type)

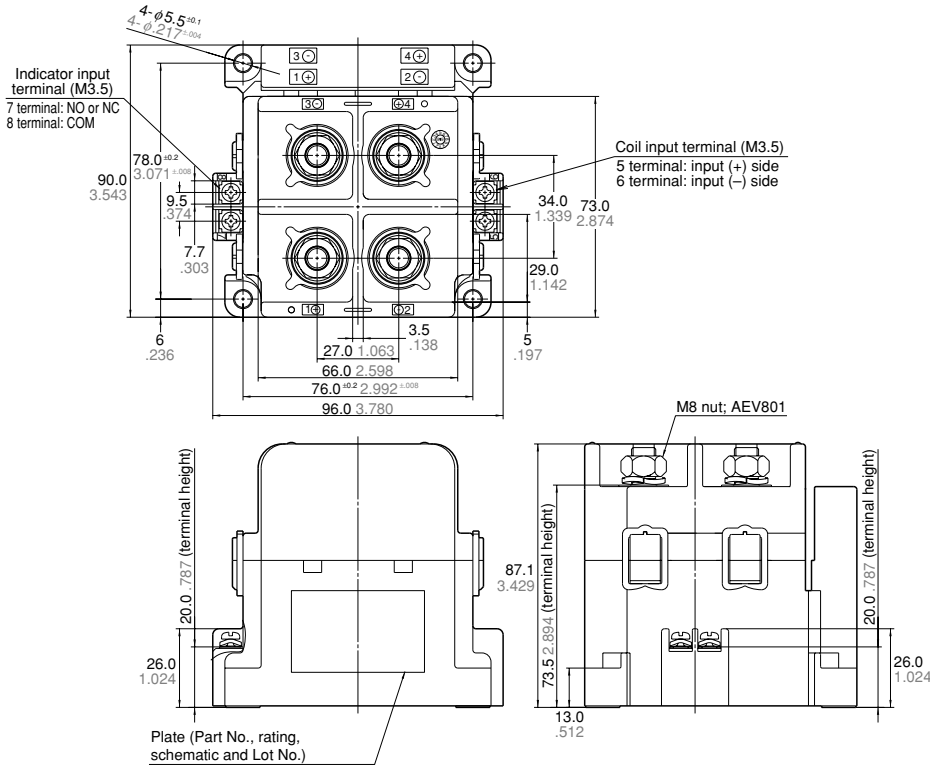

Schematic (TOP VIEW)  
1 Form A

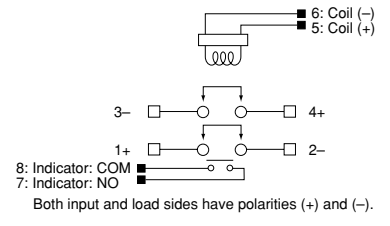

1 Form B

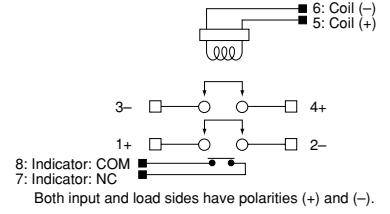

Mounting dimensions

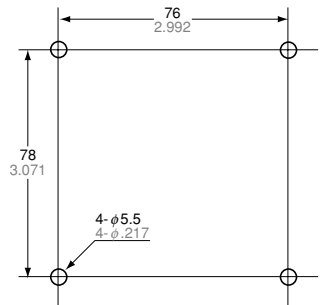

General tolerance:

- less than 10 .394 ±0.3 ±.012
- 10 .394 to 50 1.969 ±0.6 ±.024
- more than 50 1.969 ±1.0 ±.039

150A 1 Form A

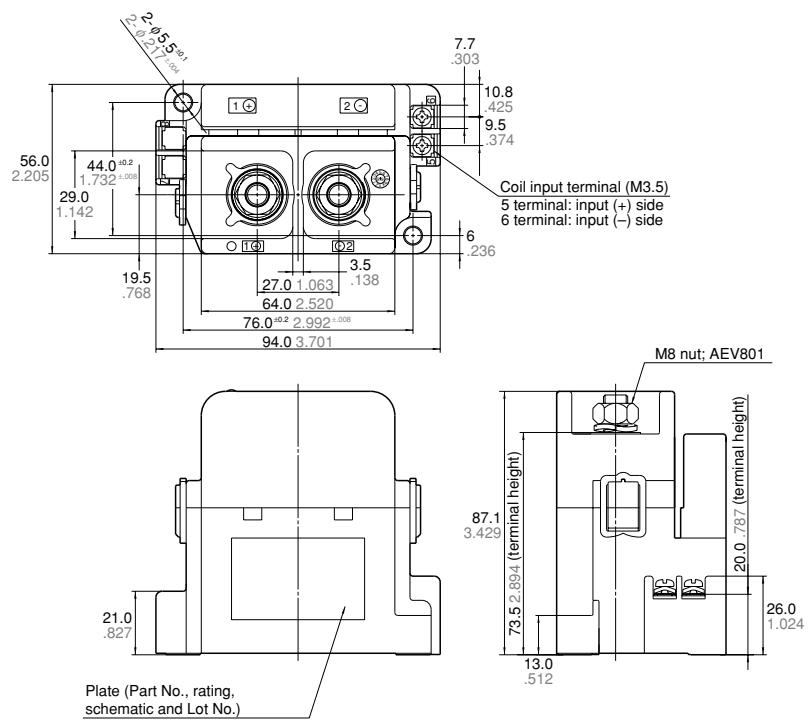

Schematic (TOP VIEW)

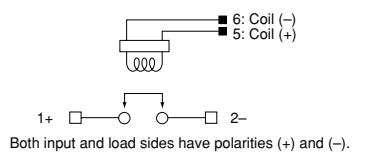

Mounting dimensions

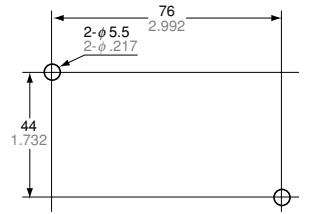

General tolerance:

- less than 10 .394 ±0.3 ±.012
- 10 .394 to 50 1.969 ±0.6 ±.024
- more than 50 1.969 ±1.0 ±.039

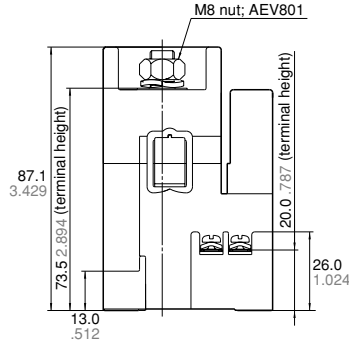
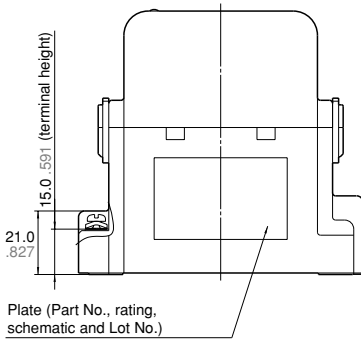
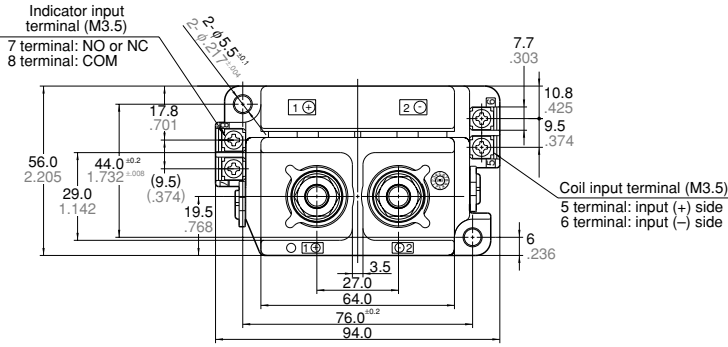

Schematic (TOP VIEW)  
1 Form A

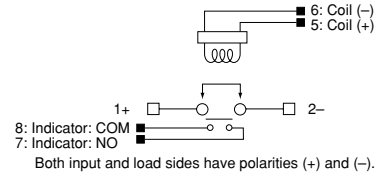

1 Form B

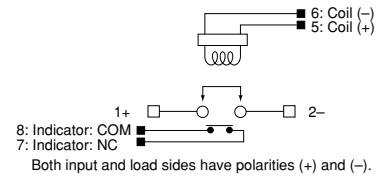

Mounting dimensions

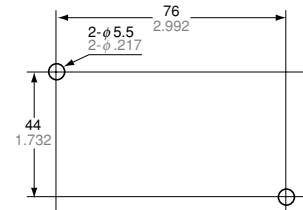

**General tolerance:**

less than 10 .394 ±0.3 ±0.12  
 10 .394 to 50 1.969 ±0.6 ±0.24  
 more than 50 1.969 ±1.0 ±0.39

**60A**

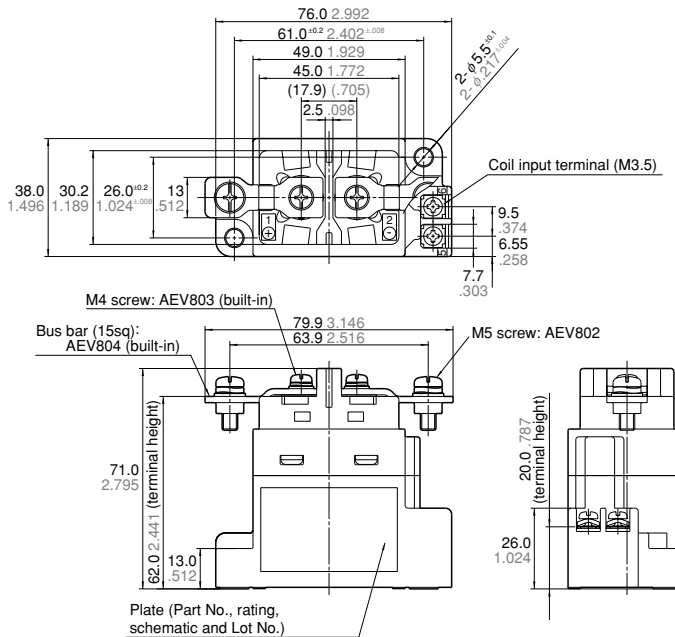

Schematic (TOP VIEW)

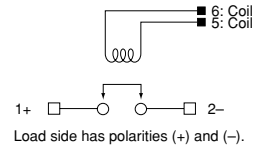

Mounting dimension

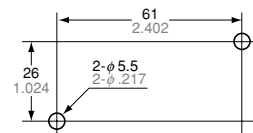

**General tolerance:**

less than 10 .394 ±0.3 ±0.12  
 10 .394 to 50 1.969 ±0.6 ±0.24  
 more than 50 1.969 ±1.0 ±0.39

10A PC board type

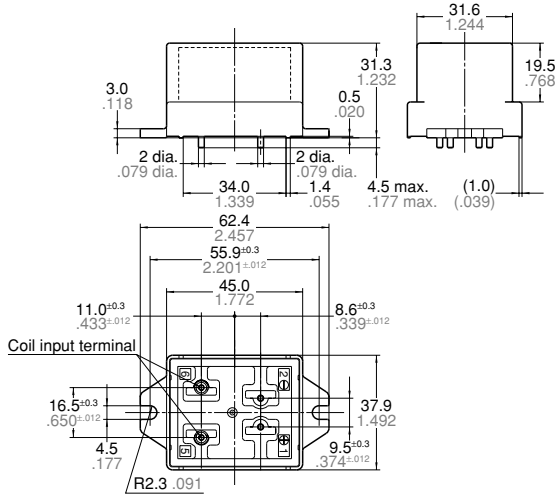

Schematic (TOP VIEW)

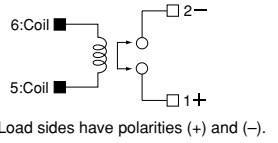

Mounting dimensions

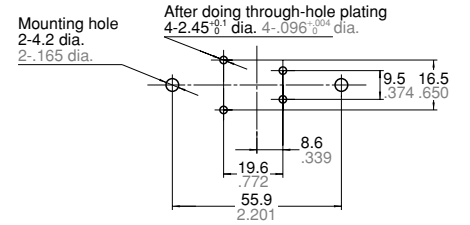

General tolerance:

- less than 10 .394 ±0.3 ±.012
- 10 .394 to 50 1.969 ±0.6 ±.024
- more than 50 1.969 ±1.0 ±.039

- Notes:
1. We recommend through-hole plating with land on both sides.
  2. Be careful of the insulation distance between land patterns with regards to the circuit voltage you will use.

10A TM type

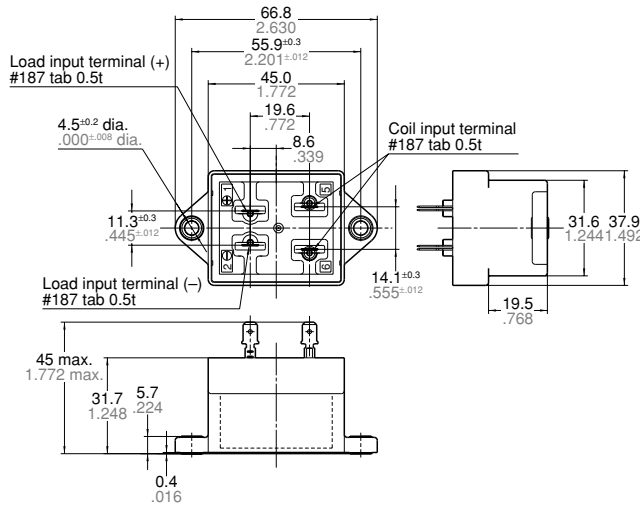

Schematic (TOP VIEW)

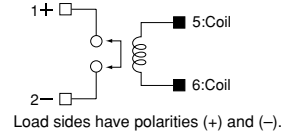

Mounting dimensions

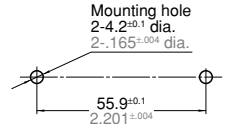

General tolerance:

- less than 10 .394 ±0.3 ±.012
- 10 .394 to 50 1.969 ±0.6 ±.024
- more than 50 1.969 ±1.0 ±.039

REFERENCE DATA

1-(1) Ambient temperature characteristics (150 A type)  
Sample: AEP15012, 3pcs

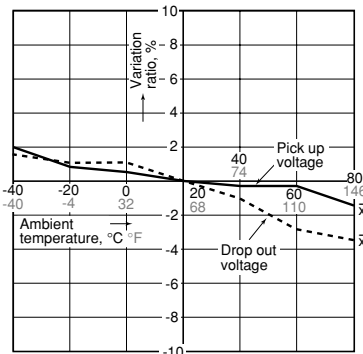

1-(2) Ambient temperature characteristics  
Sample: AEP16012, 3pcs

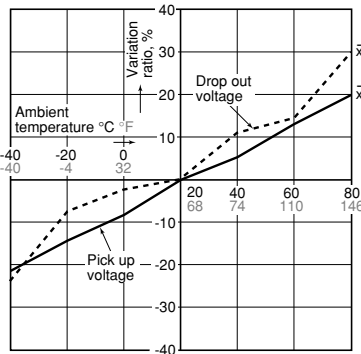

1-(3) Ambient temperature characteristics  
Sample: AEP51012, 3pcs

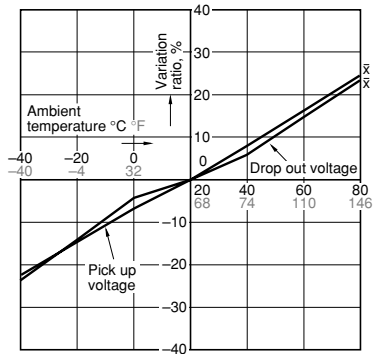

2. Max. switching capacity

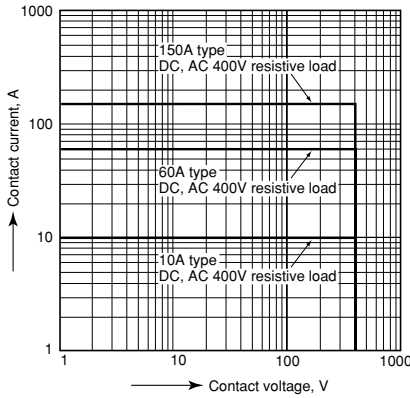

3-1) Switching life curve (150A, 60A type)

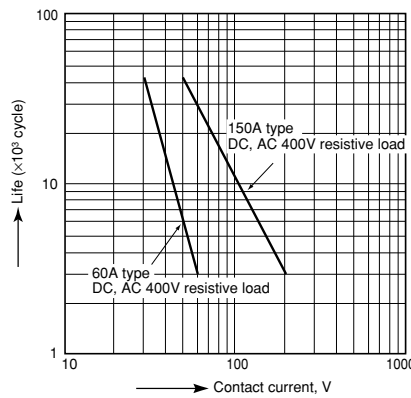

3-2) Switching life curve (10A type)

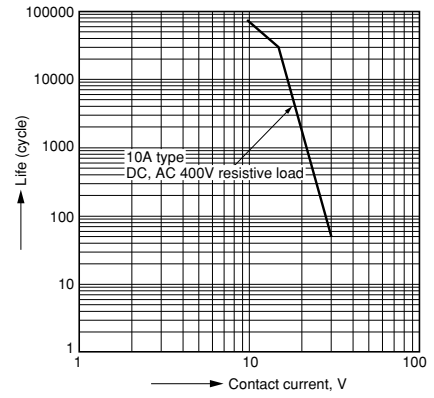

4. Cut-off life curve

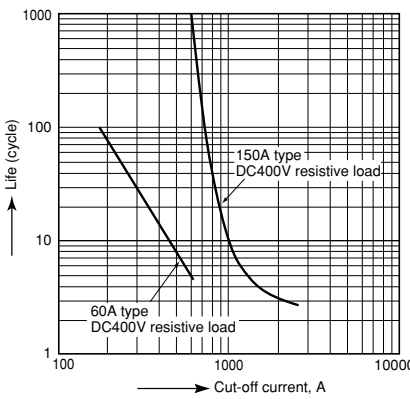

5. Carrying performance curve

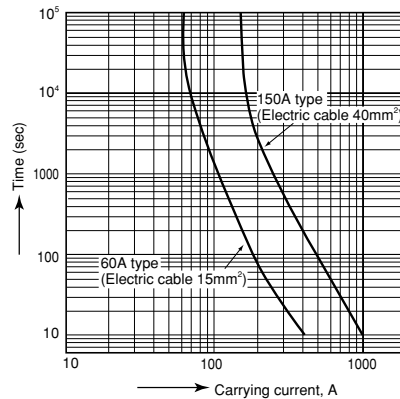

NOTES

1. When installing the relay, always use washers to prevent loosening of the screws.

Tighten each of the screws within the rated ranges given below. Exceeding the maximum torque may result in breakage. Mounting is possible in either direction.

- M8 screw (150 A main terminal): 8 to 10 N·m
- M5 screw (150 A, 60 A main unit mounting section): 2.5N·m to 3.6N·m
- M4 screw (60 A main terminal): 1.8 to 2.7 N·m
- M3.5 screw (Input terminal): 0.84 to 1.2 N·m
- M4 screw (10 A PC board type main unit mounting section): 0.98N·m to 1.2N·m (10 A TM type main unit mounting section): 1.8N·m to 2.7N·m

2. The coils (150 A type) and the contacts (10 A, 60 A, 150 A) of the relay are polarized. Please follow instructions in the connection schematic when connecting the coils and contacts.

The 150 A type contains a reverse surge voltage absorption circuit; therefore a surge protector is not needed. We recommend installing a surge protector varistor (ZNR) for the 10 A and the 60 A types. Avoid using a diode as this may result in decreased cut-off capability.

3. As a general rule, do not use a relay if it has been dropped.

4. Avoid mounting the relay in strong magnetic fields (near a transformer or magnet) or close to an object that radiates heat.

5. Electrical life

This relay is a high-voltage direct-current switch. In its final breakdown mode, it may lose the ability to provide the proper cut-off. Therefore, do not exceed the indicated switching capacity and life. (Please treat the relay as a product with limited life and replace it when necessary.)

In the event that the relay loses cut-off ability, there is a possibility that burning may spread to surrounding parts, so configure the layout so that the power is turned off within one second.

6. Permeation life of internal gas

This relay uses a hermetically encased contact (capsule contact) with gas inside. The gas has a permeation life that is affected by the temperature inside the capsule contact (ambient temperature + temperature rise due to flow of electrical current). For this reason, make sure the ambient operating temperature is between -40 and 80°C -40 and +176°F, and the ambient storage temperature is between -40 and 85°C -40 and +185°F.

7. The case is designed to remain in place during normal use and handling. If the case is removed, the relay will not function as intended and its performance cannot be guaranteed.

8. If the power is turned off and then immediately on after applying the rated voltage (current) continuously to the relay's coil and contact, the resistance of the coil will increase due to a rise in the coil temperature. This causes the pick-up voltage to rise, and possibly exceed the rated pick-up voltage. In these circumstances, take measures such as reducing the load current, limiting the duration of current flow, and applying a coil voltage higher than the rated operating voltage (quick start).

9. Coil operating power

Pure DC current should be applied to the coil. The wave form should be rectangular. If it includes ripple, the ripple factor should be less than 5%. However, check the actual circuit since the characteristics may be slightly different. The coil must only be supplied with its rated voltage. The voltage waveform supplied to the coil should be rectangular.



**10. Don't exceed maximum coil voltage. Exceeding maximum allowable coil voltage on continuous basis will damage the relay and could cause failure.**

**11. Ensure that the rated contacts voltage and current values are not exceeded.**

**12. The rated control capacity and life are given as guides.**

The contact life is heavily influenced by the type of load and other related conditions, and these factors must be kept in consideration when using the relay.

**13. If you are using an inductive load (L load) such that  $L/R > 1$  ms, add surge protection in parallel with the inductive load. If this is not done, the electrical life will decrease and cut-off failure may occur.**

**14. When using the 150 A type, mount it as far away as possible from Wireless transmitters or devices that may generate large surges. To prevent malfunctioning due to high emission levels, it may be necessary to take measures for E.M.I., such as adding a line noise filter or an electromagnetic shield.**

**15. A slight amount of superimposed line noise may be generated in the input line the coil current control. It is recommended to install a line filter to reduce or eliminate this noise.**

**16. Ensure that the main terminals are clean from oils and other foreign matters. Contamination is likely to cause increase in the terminal's temperature.**

- 150A type: nominal cross sectional area: min. 38mm<sup>2</sup>.
- 60A type: nominal cross sectional area: min. 14mm<sup>2</sup>.
- 10A TM type: Faston terminal for #187 tab terminal, 0.5 mm board thickness (JIS C2809-1992 compliant, flat type connection terminal)  
 Harness nominal cross sectional area  
 Load input terminal: min. 1.3 mm<sup>2</sup>  
 Coil input terminal: min. 0.3 mm<sup>2</sup>

**17. Avoid excessive stress on the terminals. Excessive stress can effect the performance of the contact operation.**

- M8 screw terminal (150A main terminal part)  
 Terminal pulling up strength ; Max.100N per terminal  
 The up-down rotation torque applied to the terminal ; Max.15N• m

**18. Use 40N to 70N of force as a guide to fasten the terminal connected to the 10A TM type. Please use caution when inserting or removing the terminal as the relay tab terminal may cause injury.**

**19. Place the PCB mount type (10A PCB type) securely by hand soldering after attaching it. Don't submerge assembled board in cleaning solution or water. Also, be careful not let flux overflow up from the PCB or adhere to the base of the relay.**

**20. Make sure the power is turned off when wiring.**

**21. Incorrect wiring may cause unexpected malfunction and failure.**

**22. For AC cut-off, there is no contact polarity. Confirm electrical life using actual load. In the case of DC cut-off, please note the contact polarity.**

**23. Lead-free solder (tin, silver and copper) is used as the spare solder for the terminals of the PCB mount type (10A PCB type).**

**For Cautions for Use, see Relay Technical Information.**