



# NuTiny-SDK-M0518SD2AE User Manual

*The information described in this document is the exclusive intellectual property of Nuvoton Technology Corporation and shall not be reproduced without permission from Nuvoton.*

*Nuvoton is providing this document only for reference purposes of NuMicro™ microcontroller based system design. Nuvoton assumes no responsibility for errors or omissions.*

*All data and specifications are subject to change without notice.*

*For additional information or questions, please contact: Nuvoton Technology Corporation.*



## Table of Contents

1	Overview .....	3
2	Introduction to NuTiny-SDK- M0518SD2AE .....	4
2.1	NuTiny-SDK- M0518SD2AE Jumper Description .....	5
2.2	Pin Assignment for Extended Connectors .....	6
2.3	NuTiny-SDK- M0518SD2AE PCB Placement .....	8
3	Starting to Use NuTiny-SDK- M0518SD2AE on the Keil $\mu$ Vision <sup>®</sup> IDE .....	9
3.1	Downloading and Installing Keil $\mu$ Vision <sup>®</sup> IDE Software .....	9
3.2	Downloading and Installing Nuvoton Nu-Link Driver .....	9
3.3	Hardware Setup .....	9
3.4	Example Program .....	10
4	Starting to Use NuTiny-SDK- M0518SD2AE on the IAR Embedded Workbench .....	11
4.1	Downloading and Installing IAR Embedded Workbench Software .....	11
4.2	Downloading and Installing Nuvoton Nu-Link Driver .....	11
4.3	Hardware Setup .....	11
4.4	Example Program .....	12
5	NuTiny-SDK- M0518SD2AE Schematics .....	13
5.1	NuTiny-EVB- M0518SD2AE Schematic .....	13
5.2	NuTiny-EVB- M0518SD2AE Schematic .....	14
5.3	Nu-Link-Me Schematic .....	15
6	Downloading NuMicro <sup>™</sup> Related Files from Nuvoton Website .....	16
6.1	Downloading NuMicro <sup>™</sup> Keil $\mu$ Vision <sup>®</sup> IDE Driver .....	16
6.2	Downloading NuMicro <sup>™</sup> IAR EWARM Driver .....	18
6.3	Downloading NuMicro <sup>™</sup> M0518SD2AE Series BSP Software Library .....	20
7	Revision History .....	22



## 1 Overview

The NuTiny-SDK- M0518SD2AE is a specific development tool for NuMicro™ M0518 series by which users can develop and verify the application program easily. The NuTiny-SDK-M0518SD2AE includes two portions: NuTiny-EVB-M0518SD2AE (an evaluation board) and Nu-Link-Me (Debug Adaptor). With the NuTiny-SDK-M0518SD2AE, users do not need additional ICE or debug equipment.

## 2 Introduction to NuTiny-SDK- M0518SD2AE

The following figure shows the NuTiny-SDK- M0518SD2AE for M0518SD2AE series, in which the left portion is called NuTiny-EVB- M0518SD2AE and the right portion is Debug Adaptor called Nu-Link-Me.

The NuTiny-EVB- M0518SD2AE is similar to other development board. Users can use it to develop and verify applications to emulate the real behavior. In fact, the real chip M0518SD2AE is mounted on the board. The NuTiny-EVB- M0518SD2AE can be a real system controller to design user target system.

The Nu-Link-Me is a Debug Adaptor which connects the USB port of your PC to your target system (via Serial Wired Debug Port) and allows you to program and debug embedded programs on the target hardware. To use the Nu-Link-Me Debug adaptor with Keil or IAR, please refer to “Nuvoton NuMicro™ IAR ICE Driver User Manual” or Nuvoton NuMicro™ Keil ICE Driver User Manual” for details.

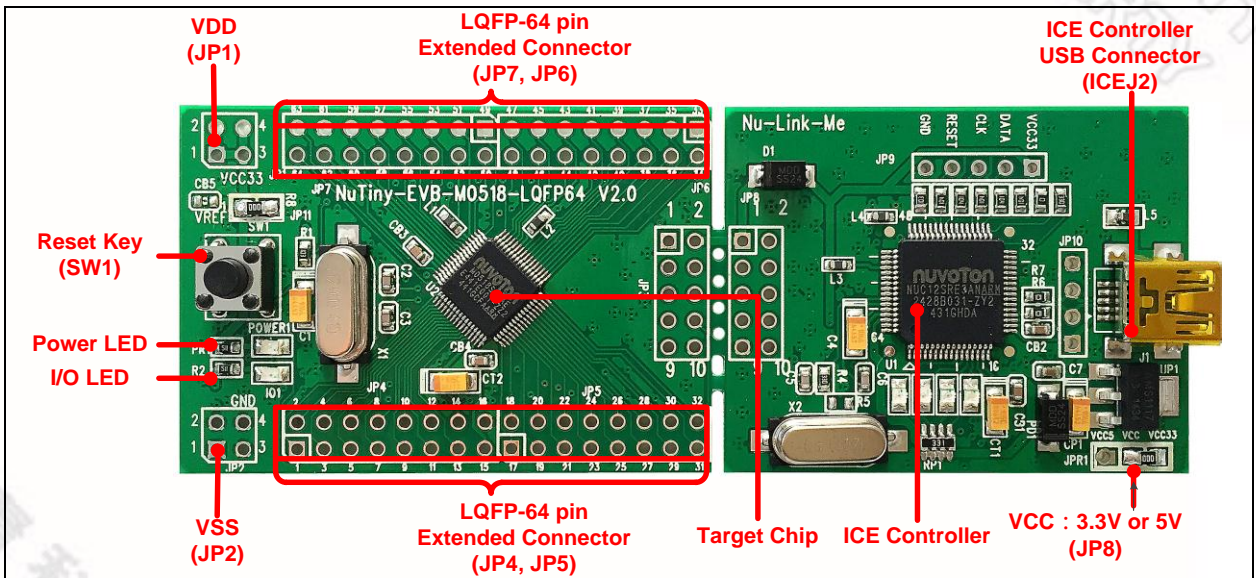

Figure 2-1 NuTiny-SDK- M0518SD2AE (Green PCB Board)

## 2.1 NuTiny-SDK- M0518SD2AE Jumper Description

### 2.1.1 Power Settings

- **JP1**: VDD Voltage connector in NuTiny-EVB- M0518SD2AE
- **J1**: USB port in Nu-Link-Me

Model	JPR1	J1 USB port	JP1 VDD	MCU Voltage
Model 1	Select VCC33 (default)	Connect to PC	DC 3.3V output	DC 3.3V
Model 2	X	X	DC 2.5 V ~ 5.5 V Input	Voltage by <b>JP1</b> input

X: Unused.

### 2.1.2 Debug Connectors

- **JP3**: Connector in target board (NuTiny-EVB- M0518SD2AE) for connecting with Nuvoton ICE adaptor (Nu-Link-Me)
- **JP8**: Connector in ICE adaptor (Nu-Link-Me) for connecting with a target board (e.g. NuTiny-EVB- M0518SD2AE)

### 2.1.3 USB Connectors

- **J1**: Mini USB Connector in Nu-Link-Me connected to a PC USB port

### 2.1.4 Extended Connectors

- **JP4, JP5, JP6 and JP7**: Show all chip pins in NuTiny-EVB- M0518SD2AE

### 2.1.5 Buttons

- **SW1**: Reset button in NuTiny-EVB- M0518SD2AE

### 2.1.6 Power Connectors

- **JP1**: VDD connector in NuTiny-EVB- M0518SD2AE
- **JP2**: VSS connector in NuTiny-EVB- M0518SD2AE





## 2.2 Pin Assignment for Extended Connectors

The NuTiny-EVB- M0518SD2AE provides the M0518SD2AE target chip on board and the extended connectors (**JP4**, **JP5**, **JP6** and **JP7**) for LQFP48-pin. The following table is the pin assignment for M0518SD2AE.

Pin No	Pin Name	Pin No	Pin Name
01	PB.14,INT0	33	PC.11,PWM1_BRAKE1
02	PB.13	34	PC.10,PWM1_BRAKE0
03	PB.12,CLKO,BPWM1_CH3	35	PC.9,PWM0_BRAKE1
04	PF.5,I2C0_SCL,PWM1_CH5	36	PC.8,PWM0_BRAKE0
05	PF.4,I2C0_SDA,PWM1_CH4	37	PA.15,PWM0_CH3
06	PA.11,I2C1_SCL,PWM1_CH3	38	PA.14,PWM0_CH2
07	PA.10,I2C1_SDA,PWM1_CH2	39	PA.13,PWM0_CH1,UART5_TXD
08	PA.9,I2C0_SCL,UART1_nCTS	40	PA.12,PWM0_CH0,UART5_RXD
09	PA.8,I2C0_SDA,UART1_nRTS	41	PF.7,ICE_DAT
10	PB.4,UART1_RXD	42	PF.6,ICE_CLK
11	PB.5,UART1_TXD	43	AVSS
12	PB.6,UART1_nRTS	44	PA.0,PWM0_CH4,ADC0,I2C1_SCL,UART5_TXD
13	PB.7,UART1_nCTS	45	PA.1,PWM0_CH5,ADC1,I2C1_SDA,UART5_RXD
14	LDO_CAP	46	PA.2,PWM1_CH0,ADC2,UART3_TXD
15	VDD	47	PA.3,PWM1_CH1,ADC3,UART3_RXD
16	VSS	48	PA.4,ADC4
17	PB.0,UART0_RXD	49	PA.5,UART3_RXD,ADC5
18	PB.1,UART0_TXD	50	PA.6,UART3_TXD,ADC6
19	PB.2,UART0_nRTS,TM2_EXT,TM2,PWM1_BRAKE1	51	PA.7,Vref,ADC7
20	PB.3,UART0_nCTS,TM3_EXT,TM3,PWM1_BRAKE0	52	AVDD
21	PD.6,BPWM1_CH1	53	PC.7,PWM0_BRAKE1,I2C0_S



			CL,UART4_RXD
22	PD.7,BPWM1_CH0	54	PC.6,PWM0_BRAKE0,I2C0_SDA,UART4_TXD
23	PD.14,BPWM0_CH5,UART2_RXD	55	PC.15
24	PD.15,BPWM0_CH4,UART2_TXD	56	PC.14
25	PC.3,BPWM0_CH3,SPI0_MOSI0	57	PB.15, ,BPWM1_CH5TM0, TM0_EXT,INT1
26	PC.2,BPWM0_CH2,SPI0_MISO0	58	PF.0,XT1_OUT
27	PC.1,BPWM0_CH1,SPI0_CLK	59	PF.1,XT1_IN
28	PC.0,BPWM0_CH0,SPI0_SS0	60	nRESET
29	PE.5,PWM0_CH5, TM1_EXT, TM1	61	VSS
30	PB.11, TM3, PWM0_CH4	62	VDD
31	PB.10, TM2	63	PF.8, PWM1_CH4, CLKO
32	PB.9, TM1	64	PB.8,BPWM1_CH2,CLKO, TM0,STADC

Table 2-1 Pin Assignment for M0518SD2AE

## 2.3 NuTiny-SDK- M0518SD2AE PCB Placement

The following figure shows the NuTiny-SDK- M0518SD2AE PCB placement.

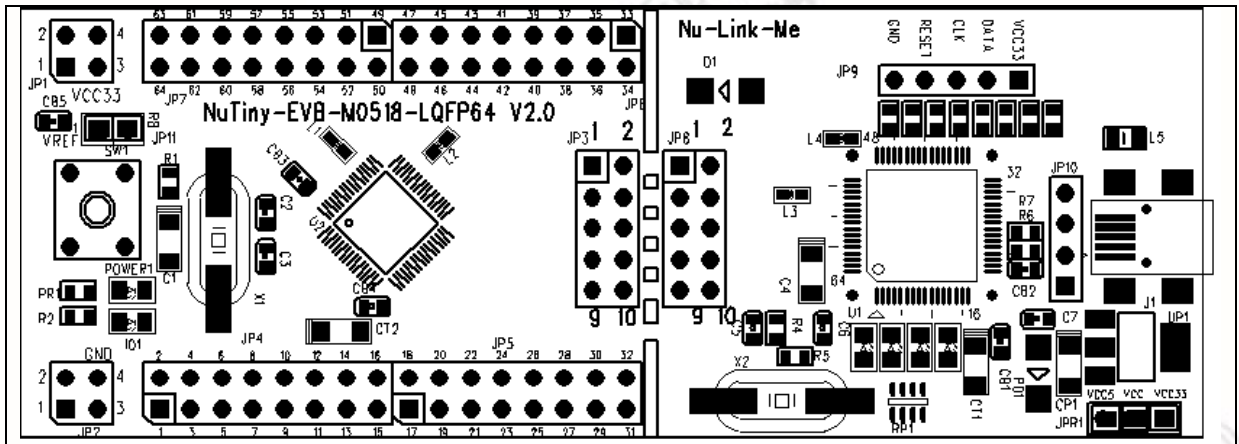

Figure 2-2 NuTiny-SDK- M0518SD2AE PCB Placement



## 3 Starting to Use NuTiny-SDK- M0518SD2AE on the Keil $\mu$ Vision<sup>®</sup> IDE

### 3.1 Downloading and Installing Keil $\mu$ Vision<sup>®</sup> IDE Software

Please connect to the Keil company website (<http://www.keil.com>) to download the Keil  $\mu$ Vision<sup>®</sup> IDE and install the RVMDK.

### 3.2 Downloading and Installing Nuvoton Nu-Link Driver

Please connect to Nuvoton NuMicro<sup>™</sup> website (<http://www.nuvoton.com/NuMicro>) to download the “NuMicro<sup>™</sup> Keil  $\mu$ Vision<sup>®</sup> IDE driver” file. Please refer to *section 6.1* for the detailed download flow. After the Nu-Link driver is downloaded, please unzip the file and execute the “Nu-Link\_Keil\_Driver.exe” to install the driver.

### 3.3 Hardware Setup

The hardware setup is shown in the following figure.



Figure 3-1 NuTiny-SDK- M0518SD2AE Hardware Setup

### 3.4 Example Program

This example demonstrates how to download and debug an application on a NuTiny-SDK- M0518SD2AE board.

The example file can be found in the directory list shown in the following figure.

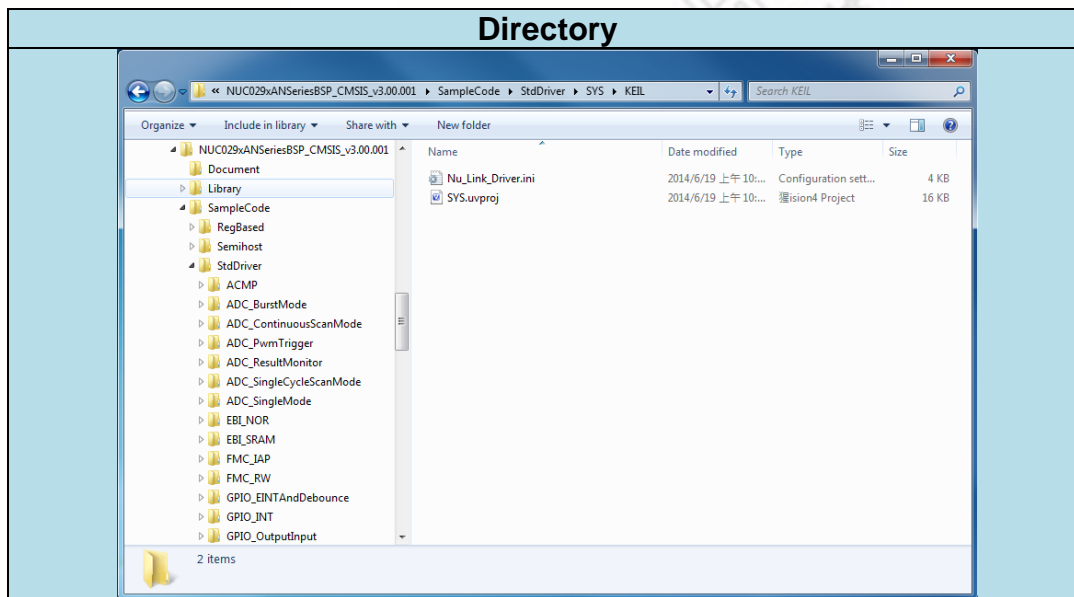

Figure 3-2 Example Directory

To use this example:

The I/O LED on the NuTiny-EVB- M0518SD2AE board will turn on.

- **Start µVision®**
- **Project – Open**  
Open the SYS.uvproj project file
- **Project – Build**  
Compile and link the SYS application
- **Flash – Download**  
Program the application code into on-chip Flash ROM
- **Start Debug mode**  
When using the debugger commands, you may:
  - ◆ Review variables in the watch window
  - ◆ Single step through code
  - ◆ Reset the device
  - ◆ Run the application

## 4 Starting to Use NuTiny-SDK- M0518SD2AE on the IAR Embedded Workbench

### 4.1 Downloading and Installing IAR Embedded Workbench Software

Please connect to IAR company website (<http://www.iar.com>) to download the IAR Embedded Workbench and install the EWARM.

### 4.2 Downloading and Installing Nuvoton Nu-Link Driver

Please connect to Nuvoton Company NuMicro™ website (<http://www.nuvoton.com/NuMicro>) to download “NuMicro™ IAR EWARM Driver” file. Please refer to *section 6.2* for the detail download flow. After the Nu-Link driver is downloaded, please unzip the file and execute the “Nu-Link\_IAR\_Driver.exe” to install the driver.

### 4.3 Hardware Setup

The hardware setup is shown in the following figure.



Figure 4-1 NuTiny-SDK- M0518SD2AE Hardware Setup

## 4.4 Example Program

This example demonstrates how to download and debug an application on a NuTiny-SDK- M0518SD2AE board.

The example file can be found in the directory list shown in the following figure.

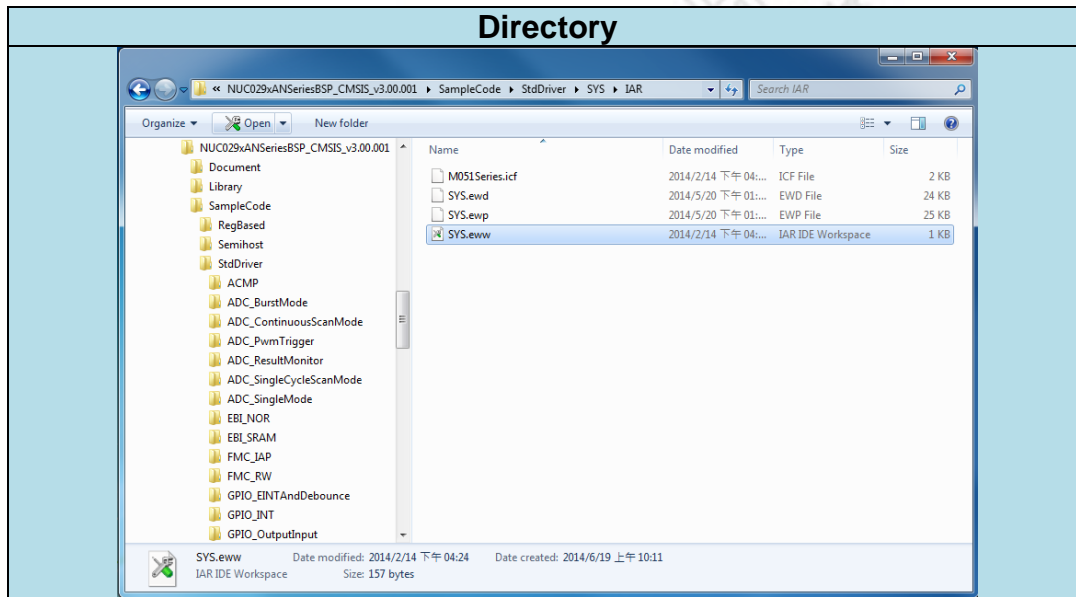







Figure 4-2 Example Directory

To use this example:

The I/O LED on the NuTiny-EVB- M0518SD2AE board will turn on.

-  **Start IAR Embedded Workbench**
- **File-Open-Workspace**  
Open the SYS.eww workspace file
-  **Project - Make**  
Compile and link the SYS application
-  **Project – Download and Debug**  
Program the application code into on-chip Flash ROM
  - ◆  Single step through code
  - ◆  Reset the device
  - ◆  Run the application

## 5 NuTiny-SDK- M0518SD2AE Schematics

### 5.1 NuTiny-EVB- M0518SD2AE Schematic

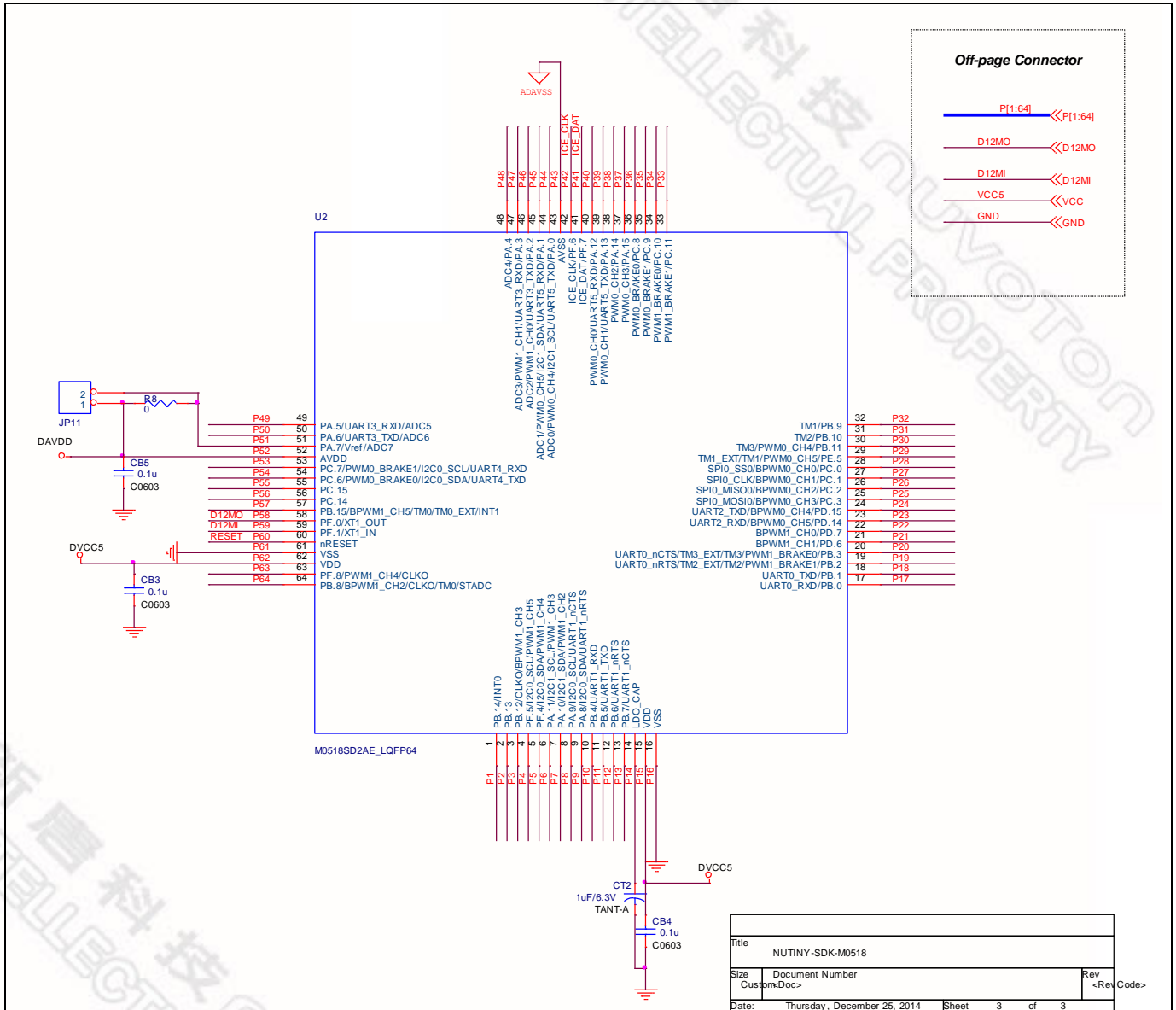

## 5.2 NuTiny-EVB- M0518SD2AE Schematic

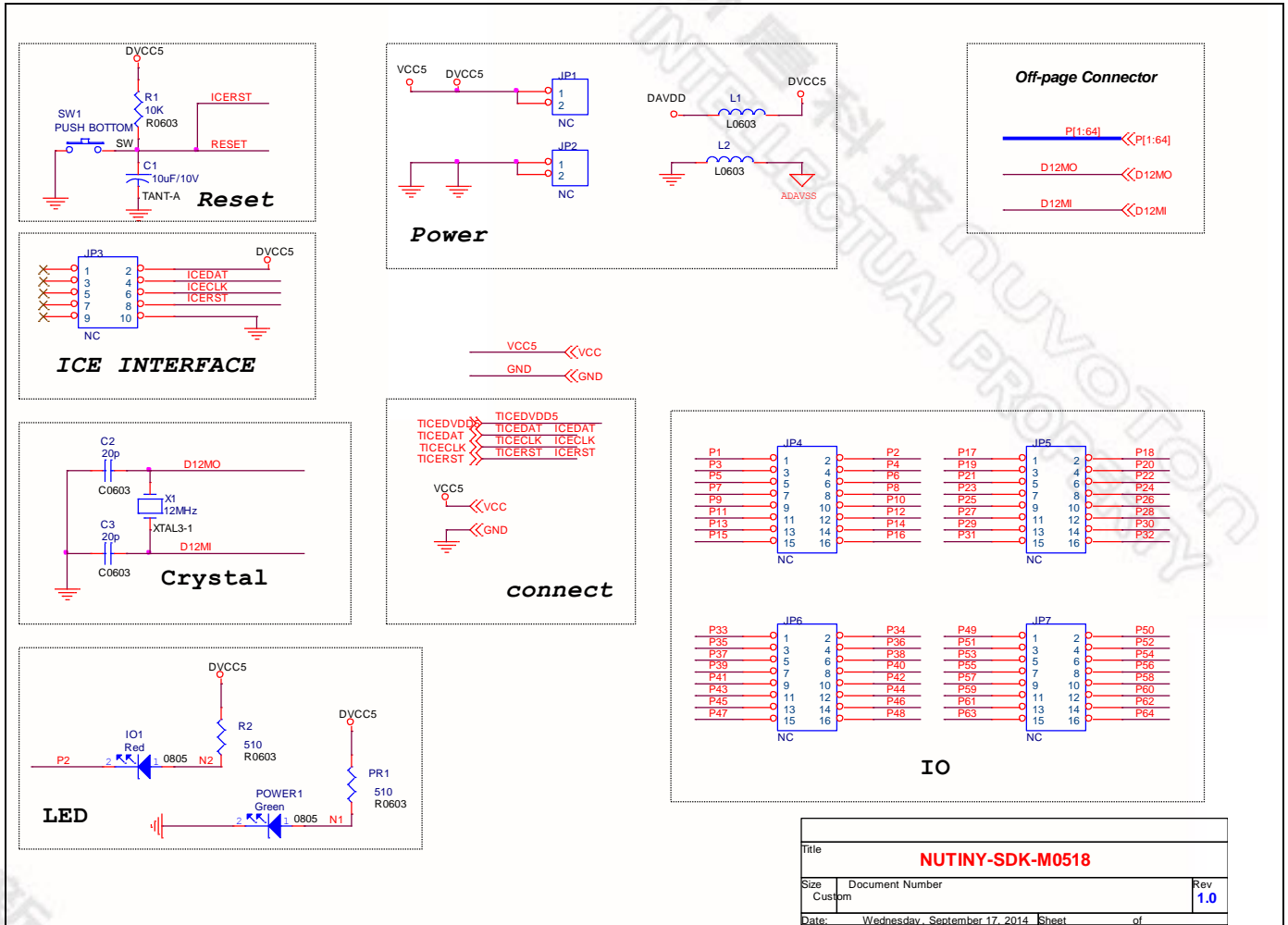



## 5.3 Nu-Link-Me Schematic

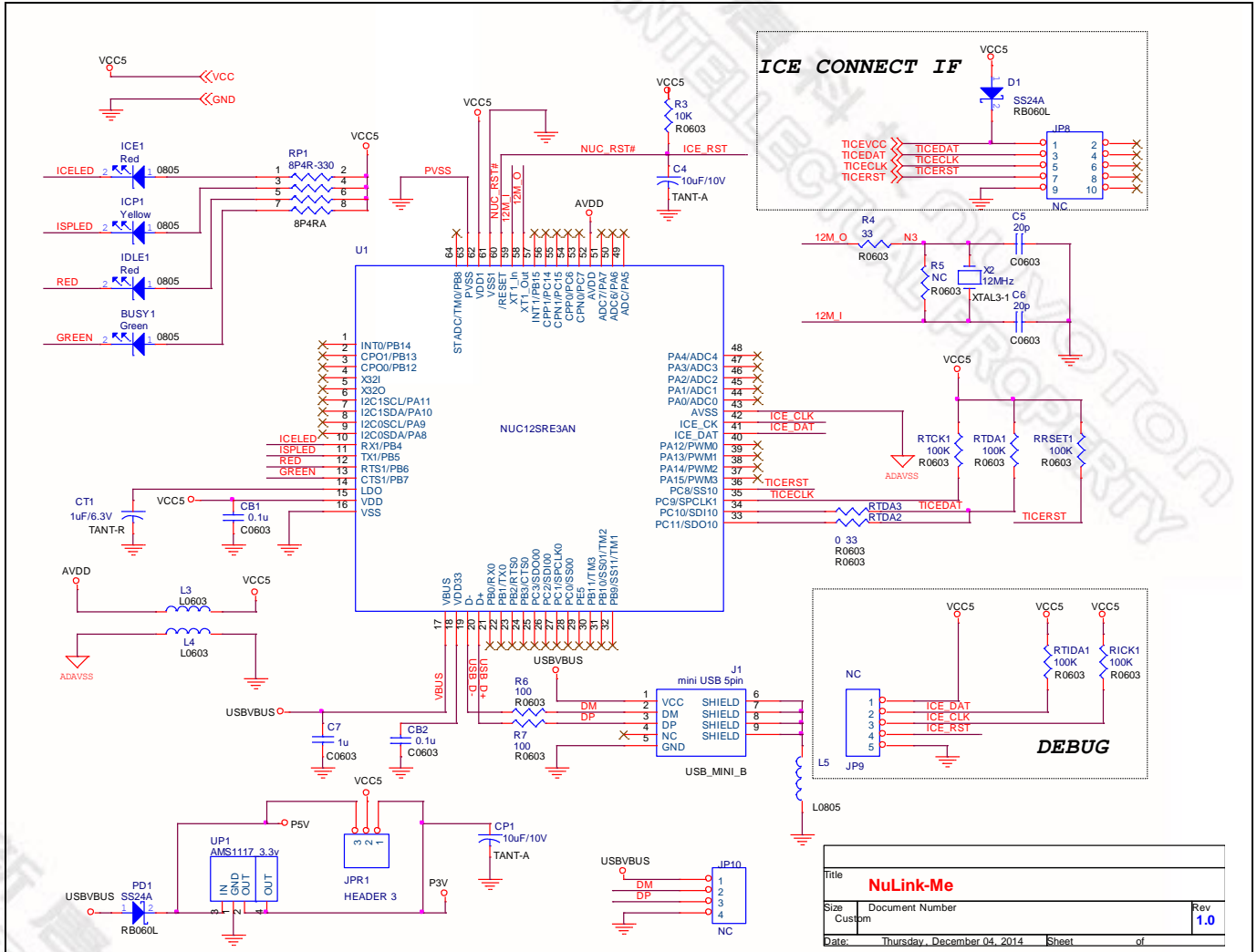



## 6 Downloading NuMicro™ Related Files from Nuvoton Website

### 6.1 Downloading NuMicro™ Keil µVision® IDE Driver

Step1	Visit the Nuvoton NuMicro™ website: <a href="http://www.nuvoton.com/NuMicro">http://www.nuvoton.com/NuMicro</a> .
Step2	<p>The screenshot shows the Nuvoton website interface. A yellow oval labeled '2-1. Move to "Support"' points to the 'Support' link in the top navigation bar. A red dashed box highlights the 'Support' dropdown menu, which includes options like 'Learning', 'Product Related Information', 'Tool &amp; Software', 'Reference Design', 'FAQ', 'Sales Support', 'Technical Support', and 'Forum'. A second yellow oval labeled '2-2. Click here to enter Tool &amp; Software' points to the 'Tool &amp; Software' option in the dropdown menu. The main content area displays a product matrix for ARM Cortex™-M0 MCUs, categorized by application (Industrial Control, Low Power, USB Application, Automotive Application, Audio Application) and memory size (16K, 32K, 64K, 128K, 256K). Specific product models like M051, Nano102, Nano112, Nano100, Nano110, Nano120, NUC100, NUC120, NUC122, NUC123, NUC130, NUC140, NUC220, NUC230, NUC240, and AU9110 are shown. A 'Featured Products' section lists M0516LDE, MINI54FDE, and NANO130KE3BN. A 'Featured Videos' section includes 'M0 Introduction(06:35)'. A 'Featured Applications' section is also visible at the bottom.</p>

Step3

Step4

**Programmer Software Tools Package**

File name	Description	Version	Date
<a href="#">ICP Programming Tool V1.27.6340.zip</a> <a href="#">Revision History</a>	NuMicro ICP tool & user manual	V1.27.6340	2014-10-30
<a href="#">ISP Programming Tool V1.44.zip</a> <a href="#">Revision History</a>	NuMicro ISP Programming Tool & user manual	V1.44	2014-09-01
<a href="#">NuGang Programmer V6.23.zip</a> <a href="#">Revision History</a>	NuMicro NuGang Programmer user manual	V6.23	2014-12-17

**Nu-Link Driver**

File name	Description	Version	Date
<a href="#">Nu-Link Driver for Keil RVMDK V1.27.6340.zip</a> <a href="#">Revision History</a>	This driver is to support Nu-Link to work under Keil RVMDK Development Environment for all NuMicro Family Devices.	V1.27.6340	2014-10-30
<a href="#">Nu-Link Driver for IAR EWARM V1.27.6340.zip</a> <a href="#">Revision History</a>	This driver is to support Nu-Link to work under IAR EWARM Development Environment for all NuMicro Family Devices.	V1.27.6340	2014-10-30

Step5

Download the NuMicro™ Keil μVision® IDE driver.



## 6.2 Downloading NuMicro™ IAR EWARM Driver

**Step1** Visit the Nuvoton NuMicro™ website: <http://www.nuvoton.com/NuMicro>.

**Step2**

The screenshot shows the Nuvoton NuMicro website interface. A yellow oval labeled "2-1. Move to 'Support'" points to the "Support" link in the top navigation bar. A red dashed box highlights the "Support" dropdown menu, with a yellow oval labeled "2-2. Click here to enter Tool & Software" pointing to the "Tool & Software" option. The main content area displays a product matrix for ARM Cortex-M0 MCUs, categorized by core size (16K, 32K, 64K, 128K, 256K) and application (Industrial Control, Low Power, USB Application, Automotive Application, Audio Application). Products shown include Mini51, M051, Nano102, Nano112, Nano100, Nano110, Nano120, NUC100, NUC120, NUC122, NUC123, NUC220, NUC240, NUC230, NUC140, NUC130, AU9110, and AU9120\*. A sidebar on the left lists "ARM Cortex™-M0 MCUs" and "Resources". A right sidebar features "Online Support" (Training, Forum, FAQ), "Featured Products" (M0516LDE, MINI54FDE, NANO130KE3BN), "Featured Videos" (M0 Introduction), and "Featured Applications".

As one of the leading Microcontroller (MCU) companies in the world, Nuvoton provides the state-



Register | Login
Language ▼

Search

Parametric Search

News | Events | CSR | Human Resources | Investors | Contact Us | NuvoTon Partner

Products
Applications
Support
Foundry Service
Buy
myNuvoTon
About NuvoTon

Home > Support > Tool & Software > Development Tool Hardware

**Development Tool Hardware**

Learning

Product Related Information

Tool & Software

Development Tool Hardware

Development Kit

Learning Board

Programmer

Software

Third Party Tool

Reference Design

FAQ

Sales Support

Technical Support

Forum

**Development**

**Mass Production**

On-Line In Circuit Programming

Customer Target Board

Off-Line In Circuit Programming

Customer Target Board

IC Programming

Novoton Gang Programmer

Third Party Writer

**Upgrade**

In System Programming

Novoton ISP AP

Through

- UART
- USB
- I2C
- SPI
- CAN
- I/O

**Events**

Nuovton Technology Hosts 32-bit Cortex™-M4 Ether... 2014-05-02

2014Q1 Investor Conference 2014-04-24

More...

**News**

Nuovton Announces Monthly Revenue for May 2014 2014-06-06

**Step3**

Click here to enter Software download page

**Programmer Software Tools Package**

File name	Description	Version	Date
ICP Programming Tool V1.27.6340.zip Revision History	NuMicro ICP tool & user manual	V1.27.6340	2014-10-30
ISP Programming Tool V1.44.zip Revision History	NuMicro ISP Programming Tool & user manual	V1.44	2014-09-01
NuGang Programmer V6.23.zip Revision History	NuGang Programmer software & user manual	V6.23	2014-12-17

**Nu-Link Driver**

File name	Description	Version	Date
Nu-Link Driver for Keil RVMDK V1.27.6340.zip Revision History	This driver is to support Nu-Link to work under Keil RVMDK Development Environment for all NuMicro Family Devices.	V1.27.6340	2014-10-30
Nu-Link Driver for IAR EWARM V1.27.6340.zip Revision History	This driver is to support Nu-Link to work under IAR EWARM Development Environment for all NuMicro Family Devices.	V1.27.6340	2014-10-30

Click here to download the file.

**Step4**

**Step5** Download the NuMicro™ IAR EWARM driver.



## 6.3 Downloading NuMicro™ M0518SD2AE Series BSP Software Library

**Step1** Visit the Nuvoton NuMicro™ website: <http://www.nuvoton.com/NuMicro>.

**Step2**

The screenshot shows the Nuvoton NuMicro website interface. A yellow oval labeled "2-1. Move to 'Support'" points to the "Support" link in the top navigation bar. A red dashed box highlights the "Support" dropdown menu, with a yellow oval labeled "2-2. Click here to enter Tool & Software" pointing to the "Tool & Software" option. The main content area displays a product matrix for ARM Cortex-M0 MCUs, categorized by core size (16K, 32K, 64K, 128K, 256K) and application (Industrial Control, Low Power, USB Application, Automotive Application, Audio Application). Various product models like NUC100, Nano120, NUC120, NUC230, Nano110, Nano140, NUC130, M051, NUC122, NUC123, Nano102, Nano112, Mini51, AU9110, NUC220, NUC240, and AU9120\* are shown. The right sidebar includes sections for "Online Support", "Featured Products", "Featured Videos", and "Featured Applications".

As one of the leading Microcontroller (MCU) companies in the world, Nuvoton provides the state-



<p><b>Step3</b></p>	<p>The screenshot shows the NuvoTon website's 'Development Tool Hardware' page. The left sidebar contains a list of links: Learning, Product Related Information, Tool &amp; Software, Development Tool Hardware, Development Kit, Learning Board, Programmer, <b>Software</b> (highlighted with a red dashed box and a yellow callout bubble), Third Party Tool, Reference Design, FAQ, Sales Support, Technical Support, and Forum. The main content area is divided into three columns: 'Development' (with links for Evaluation Board, Customer Target Board, and NuTiny Board), 'Mass Production' (with links for On-Line In Circuit Programming, Off-Line In Circuit Programming, and IC Programming), and 'Upgrade' (with links for In System Programming and Through). A yellow callout bubble with the text 'Click here to enter Software download page' points to the 'Software' link in the sidebar.</p>
<p><b>Step4</b></p>	<p>Download the NuMicro™ M0518 Series CMSIS BSP.</p>

新唐科技 NUVOTON  
INTELLECTUAL PROPERTY



## 7 Revision History

Revision	Date	Description
1.00	Des. 24, 2014	Preliminary version

### Important Notice

Nuvoton Products are neither intended nor warranted for usage in systems or equipment, any malfunction or failure of which may cause loss of human life, bodily injury or severe property damage. Such applications are deemed, "Insecure Usage".

Insecure usage includes, but is not limited to: equipment for surgical implementation, atomic energy control instruments, airplane or spaceship instruments, the control or operation of dynamic, brake or safety systems designed for vehicular use, traffic signal instruments, all types of safety devices, and other applications intended to support or sustain life.

All Insecure Usage shall be made at customer's risk, and in the event that third parties lay claims to Nuvoton as a result of customer's Insecure Usage, customer shall indemnify the damages and liabilities thus incurred by Nuvoton.

---

Please note that all data and specifications are subject to change without notice.  
All the trademarks of products and companies mentioned in this datasheet belong to their respective owners.