



Sanken High-Quality, High-Performance Power ICs
From Allegro MicroSystems, Inc.



Sanken Inverter Power Module Series **2007**

September 29, 2007



Introduction of High Voltage IPM for Motor Drive Application

- For Small Capacity Use (Up to 200W) SMA, SLA (“A” and “B” in photo)
 - ex. Fan motors for Air Conditioners, Compressor for Refrigerators, Pumps for Dishwashers, Pool Pumps, etc.
- For Middle Capacity Use (Up to 750W) SCM (“C” and “D” in photo)
 - ex. Compressors for Refrigerators and Air-Conditioners, Fan motors for Furnaces, Pumps and motors for Washers and Dryers, etc.

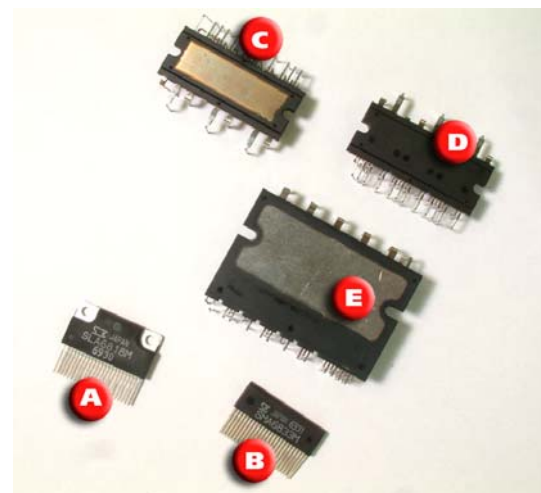

Large capacity parts (up to 1500W) are in development

IPM for Variable-Speed Motors for Home Appliances

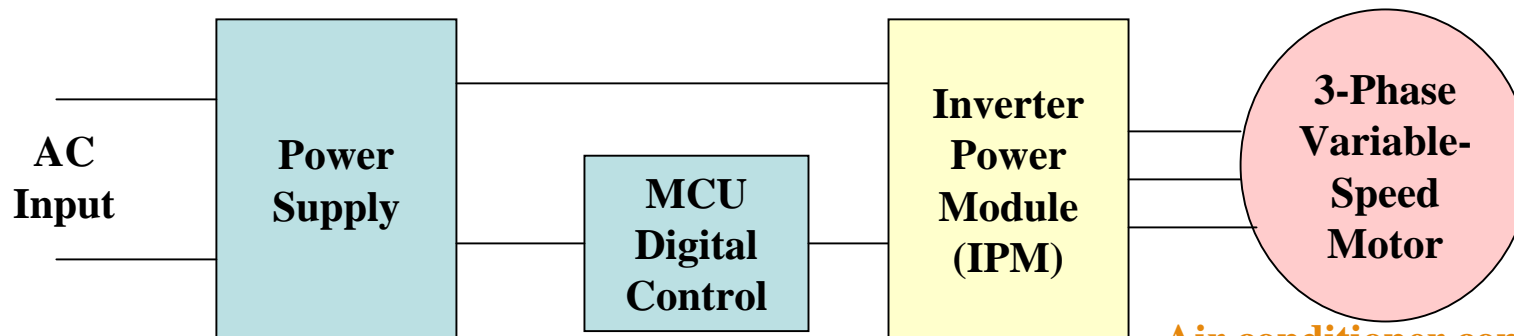

- Air conditioner compressors**
- Air conditioner fan motors**
- Refrigerator compressors**
- Washers & Dryers motors**
- Furnace fan motors**
- Dishwasher pumps**
- Pool pumps**
- Vacuum cleaner motors**
- Rug shampooers motors**
- Sump pump motors**



- Most appliance motors have been driven by inefficient electromechanical control systems, using up over 50% of USA electricity
- Electronic, variable-speed controllers, using IPM (Inverter, or Intelligent, Power Module) could save up to 60% of the energy consumed



Growing IPM Market in the USA

- NEW DRIVE since 2001: “Saving Energy” => A strategic goal in USA
 - To reduce reliance on the foreign oil
 - To follow “green” environmental goals – Energy Star requirements

Energy Use in North America
(US Department of Energy)

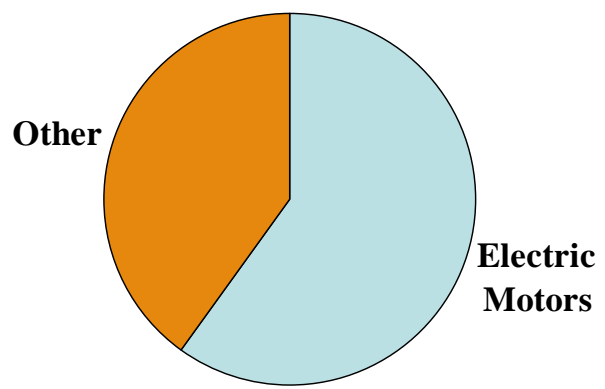

- ELECTRIC MOTORS => Over 60% of all the generated energy in the USA
 - Over 1,000 million motors in use in USA
 - 99% of motors in the USA
 - => SMALL MOTORS (15KW or less)

- Over 125 million HOMES in the USA => Each home use many motors
Major home appliances: Refrigerators, Washers & dryers, Vacuum cleaners
Air-conditioners, Furnaces, Dish washers, Rug Shampooers, Pool Pumps, etc.
- MARKET: Over 65 million major home appliances sold in 2005 in USA.
Inverters: 11% share in 2005 => Grow to 25% in 2011

Power Module for Inverter Application

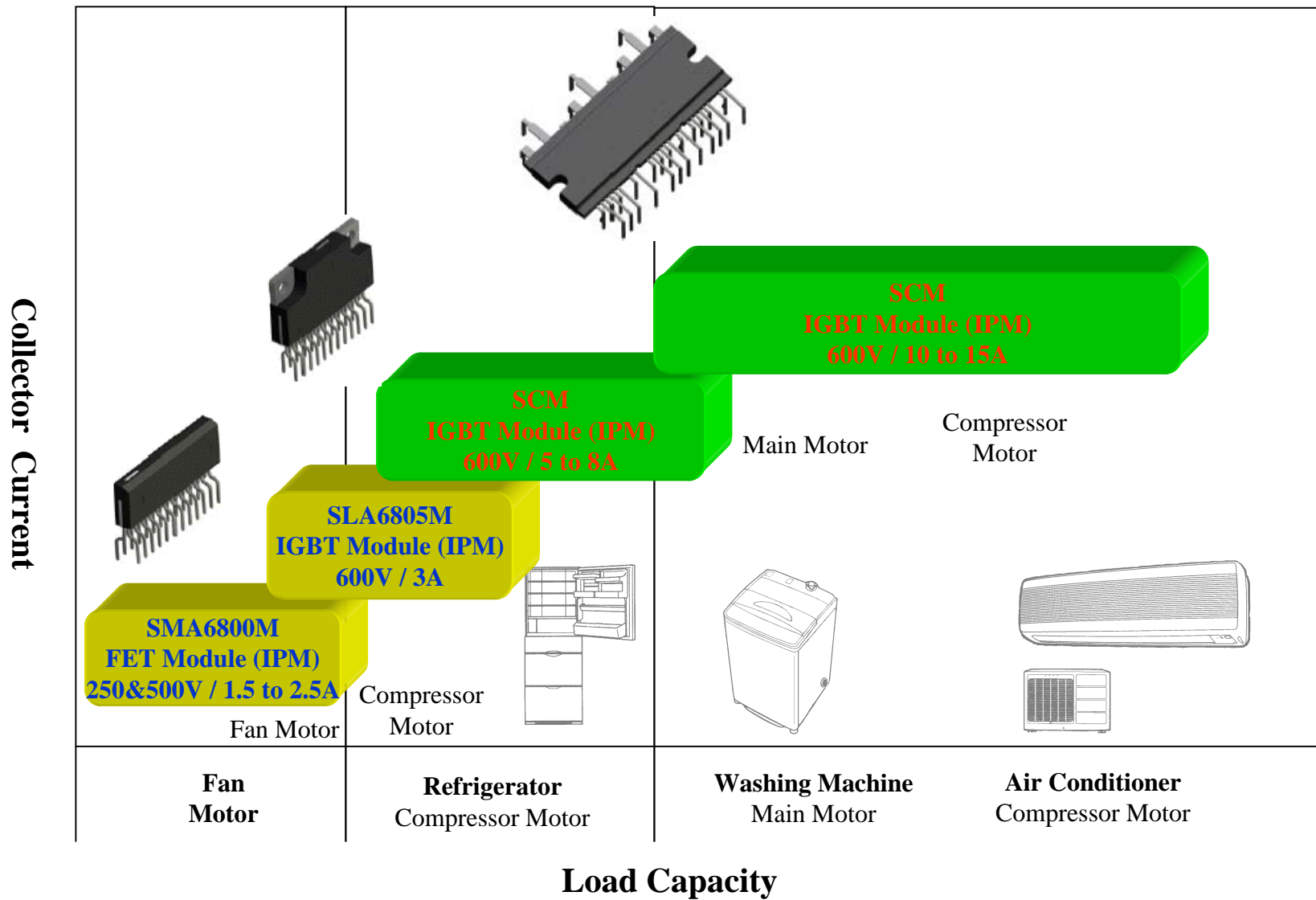



Residential Refrigerators in the USA

No. of Homes in the USA	Ave. No. of Refrig. / Home	Total No. of Refrig. in Use in the USA	No. of New Refrig. Sold in the USA	Ave. Size of Refrig. at Home in the USA	USA Energy Standard for Refrig.
125 million homes	1.2 units / Home	150 Million units	11.5 Million units / year	670 liters	Fed Std (2001) = 521KWH/yr Energy Star (2004) = 442 KWH / yr

- US Suppliers: Whirlpool (incl. Kenmore, Maytag, Amana, KitchenAid), Hotpoint, GE (incl. Hotpoint), Frigidaire (owned by Electrolux, Sweden)
- Foreign Suppliers: LG, Bosch Siemens, Samsung, Fisher & Paykel, Panasonic



Energy Star Qualified Home Refrigerators Sold in USA

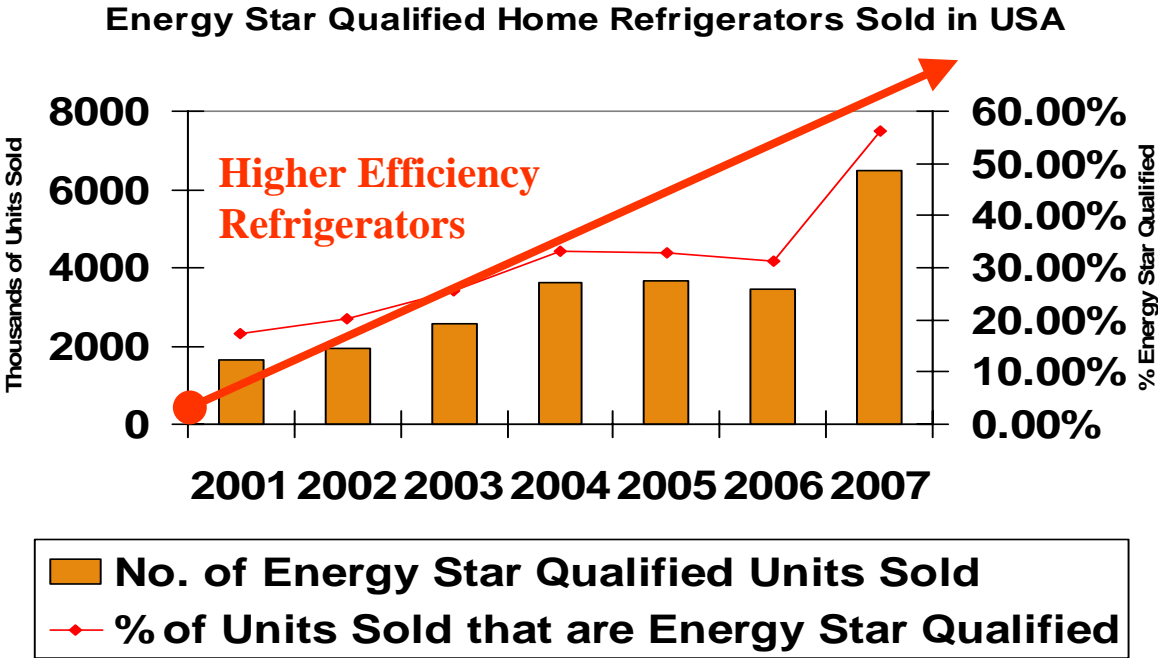

- Energy Star Standard: 2001 10% below Fed Std => 2004 15% below Fed Std
- Qualified Units Sold: 2001 1.6M units => 2004 3.6M => 2007 6.5M units
- In 2008, Energy Star Standard may be raised to “20% better than Fed Std”

Types of Refrigerators in use at Homes in the USA

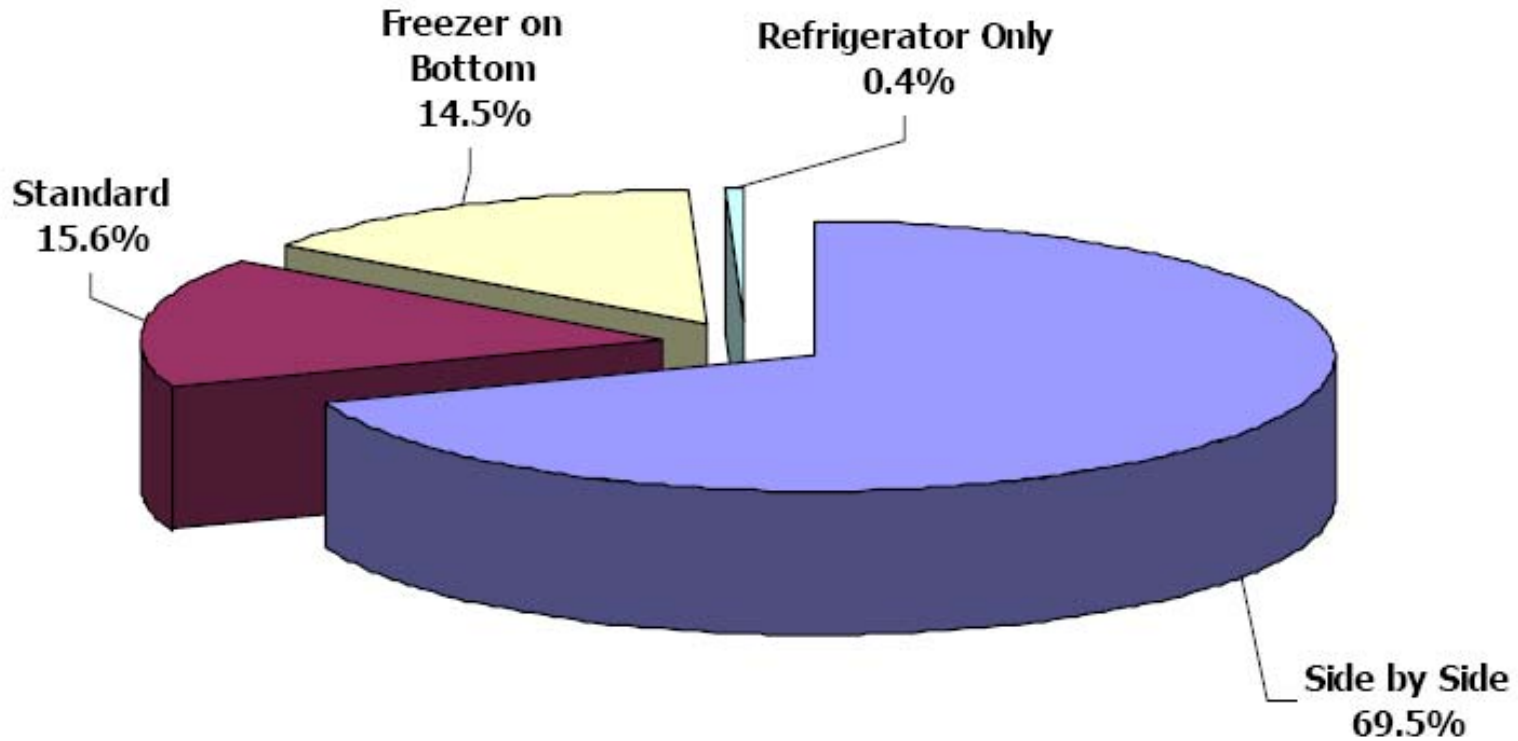



Residential Air Conditioners in the USA

No. of Homes in the USA	% of Homes with AC(s)	Total No. of AC's in Use in the USA	No. of New AC's Sold in the USA	Ave. Size of AC at Home in the USA	USA Energy Standard for AC's.
125 million homes	58% (72.5 million homes)	90 million AC units	14.0 Million units / year	3.5 ton capacity	Fed Std (2006) = SEER 13
		65M Central AC's 35M Room AC's	10M Central AC's 4M Room AC's		Energy Star (2006) = SEER 14

- AC's in the USA use over 50% of its electricity used during summer
- Central AC suppliers: Carrier, Goodman, Trane, Lennox
- Room AC suppliers: Frigidaire, GE, Whirlpool





Growth in Residential Air Conditioners (AC) in the USA

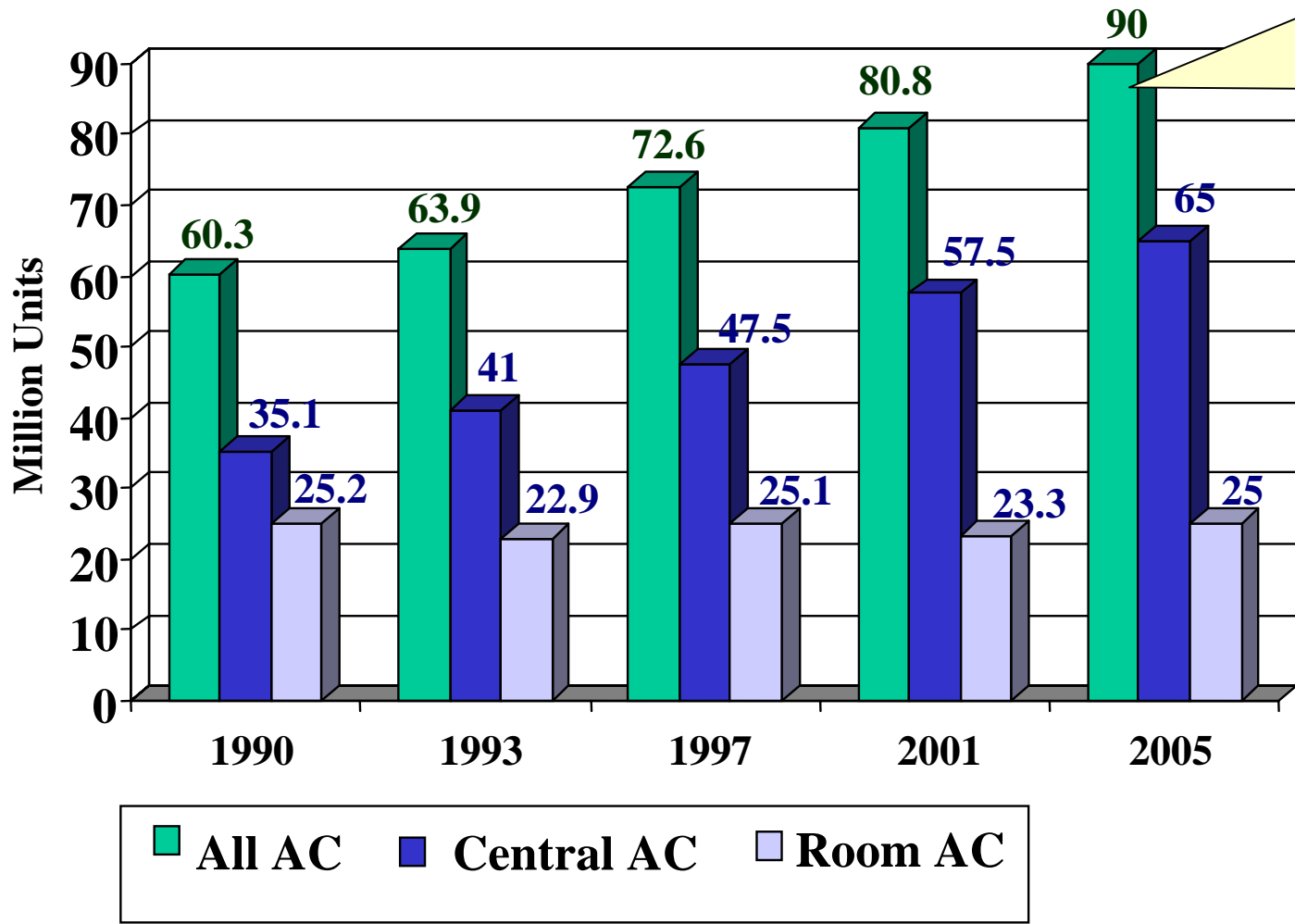

20% use inverter-based, variable-speed motor controllers.



USA Energy Regulations on Residential AC's

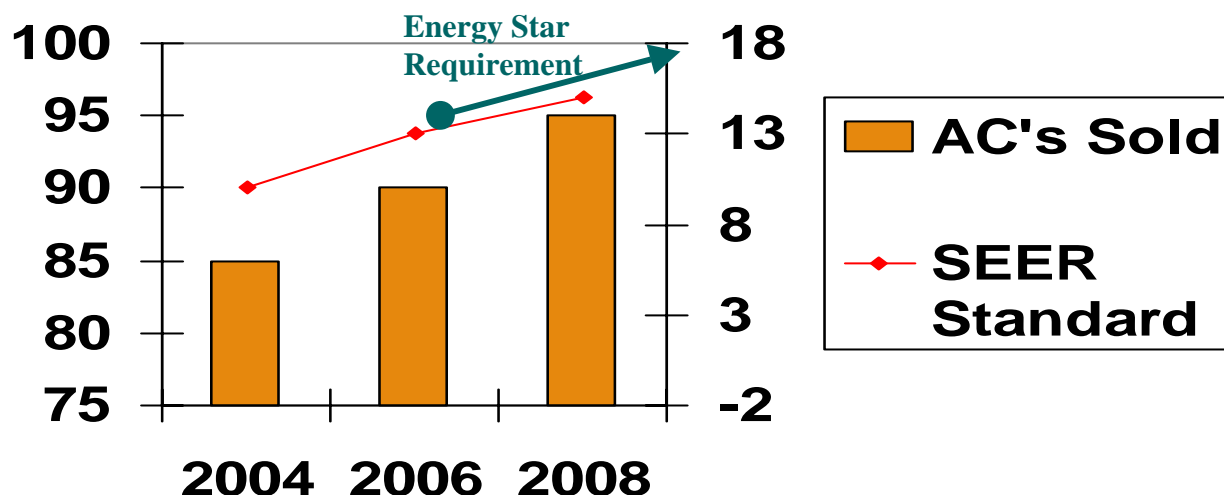

- Seasonal energy efficiency ratio (SEER) is a measure of air conditioning efficiency given in kBTU of cooling delivered per kWh of electrical energy consumed.
- In 2006, the national standard for Central AC's was raised from 10 to 13 SEER. The ENERGY STAR threshold was raised to 14 SEER.
- In 2008, the standard may be raised to 15, making it nearly imperative to use inverter-based controllers.
- For the room ACs, the current requirement is 9.7 or higher.



Residential Washers & Dryers in the USA

No. of Homes in the USA	% of Homes with Washers & Dryers	Total No. of Washers & Dryers in Use in the USA	No. of New washers & Dryers Sold in the USA	Ave. Size of Washers in use in the USA	USA Energy Standard for Washers
125 million homes	99.8%	240 million units	21.0 million units / year	Washers - 4 cubic foot capacity	Fed Std (2004) = MEF 1.04
		125M Washers 115M Dryers	11M Washers 10M Dryers		Energy Star (2004) = MEF 1.42

- 36% of washers are side-loading, which are nearly 100% inverter driven.
- Sale of inverter-driven washers in the USA grew at 23% in 2005
- Modified Energy Factor (MEF) = a ratio of cubic feet per kWh per cycle
- Suppliers: Whirlpool (also Kenmore, Maytag), Frigidaire, GE, Fisher & Paykel, Bosch



Residential Central Furnaces in the USA

No. of Homes in the USA	Ave. No. of Furnaces per Home	Total No. of Washers & Dryers in Use in the USA	No. of New washers & Dryers Sold in the USA	Ave. Size of Washers in use in the USA	USA Energy Standard for Washers
125 million homes	1.7 units	213 million units	15.0 million units / year	Gas Furnace = 69 kBtuH Electric Furnace = 2.5 kW	Fed Std (2007) = AFUE 83 Energy Star (2007) = AFUE 90
		181M Central Forced Air 18M Central Heat Pump	12.4M Natural or Propane Gas 2.6M Electric		

- Annual Fuel-Utilization Rating (AFUE) of 83 means that a minimum of 83% of the fuel consumed is directly converted to heat your home.
- The 1992 AFUE standard of 78 is being increased to 83 in the latest proposal.
- Variable speed furnaces are now available for higher efficiency.
- Suppliers: Trane, Bryant, Rheem, Armstrong (Lennox), Carrier, Goodman (incl. Amana), Coleman, York



Sanken's Power Module for Inverter Application

Sanken IPM Fundamental Structure

Introduction (SCM Series)

- A high voltage three-phase motor driver IC
- 100 to 200VAC input driver systems.
- IGBTs, or MOSFETs (for lower power)
- Each half-bridge circuit consists of a pre-driver circuit that is completely independent from the others
- Protection against simultaneous high- and low-side turning on Bootstrap diodes with series resistors for suppressing inrush current are incorporated
- CMOS compatible input (3.3 to 5 V)
- Designed to minimize simultaneous current through both high- and low-side IGBTs by optimizing gate drive resistors
- UVLO protection with auto restart
- Overcurrent protection with off-time period adjustable by an external capacitor
- Fault (FO indicator) signal output at protection activation:
- UVLO (low side only), OCP, and STP
- Proprietary power DIP package

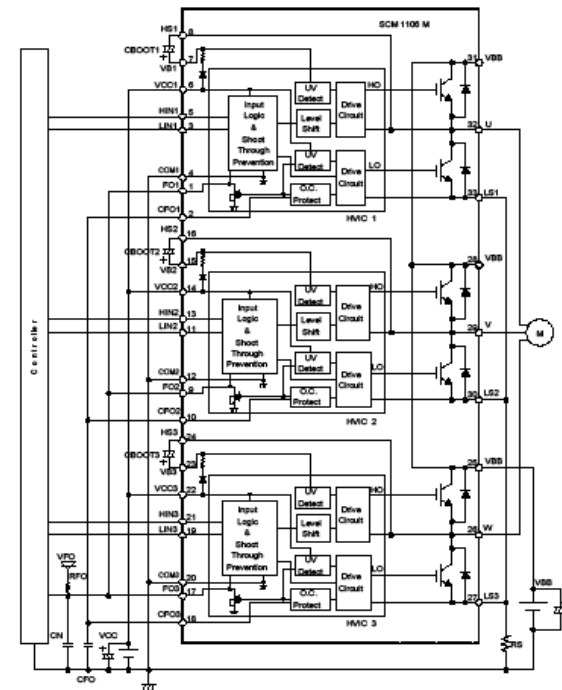



Small Capacity IPM (SIP IPM)

No. 1 Global Share in Inverter Air Conditioner Fan Application

1. Sales in 2006

SMA6800M series : 1.2M pcs

SMA6810M series : 0.6M pcs

SMA6820M series : 3.5M pcs

SLA6800M series : 0.5M pcs

Others : 0.2M pcs

Total : 6M pcs

Expected worldwide sales to double by 2008



Small Capacity IPM (SIP IPM)

SMA, SLA6800M Series

Functions and Features

- Built-in Pre-Drive IC
- Corresponding CMOS (5V) Input
- Adopted high-side driver by bootstrap topology
- Built-in protection circuit for control power supply voltage drop
- Built-in overheat detection circuit (TD) or overcurrent protection circuit (OCP)
- Output of fail signal during operation of protection circuit (during TD or OCP operation)
- $I_o=1.5$ to 3A
- Small SIP (SLA&SMA)

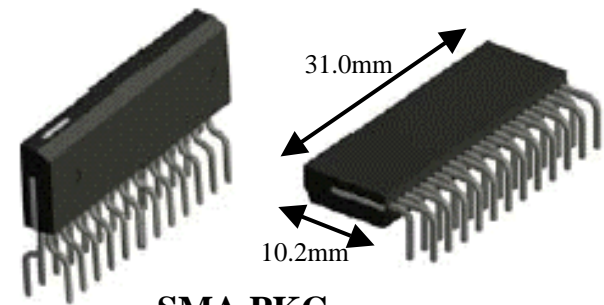

SMA PKG

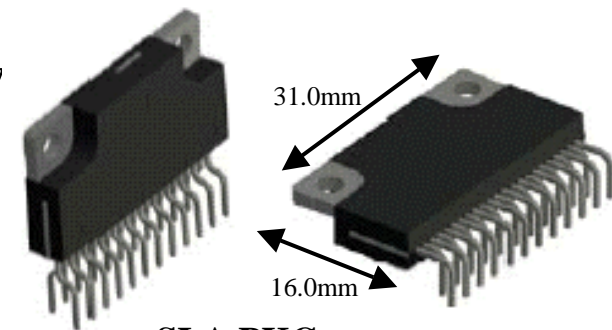

SLA PKG

Small Capacity IPM (SIP IPM)

Small size SIP (SLA&SMA) for inverter module

Realized high-density packaging (maximum 14 dies) with using SanKen unique bonding technology (BSOB)

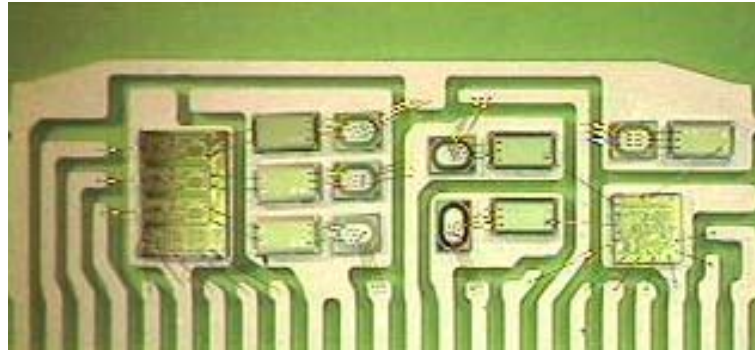
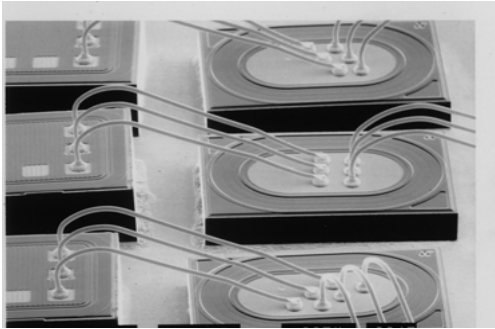

Improved surge breakdown energy by structuring power discrete chip

Multi-chip structure is employed to separate heat source. Consequently larger power dissipation is achieved.



Small Capacity IPM (SIP IPM)

Product lineup

Product No.	Vds	Id	Function	# of Pins
SLA6805M*	600V	3A	Overcurrent Protection	23
SLA6816M*	600V	3A	OCP, low noise	23
SMA6813M	500V	2.5A	Overcurrent Protection	23
SMA6843M	500V	2.5A	OHD, For 3 shunt use	24
SMA6821M	250V	2A	OHD, Reg Output, Bootstrap Di	24
SMA6822M	500V	1.5A	OHD, Reg Output, Bootstrap Di	24
SMA6823M	500V	2.5A	OHD, Reg Output, Bootstrap Di	24

***Power Device: IGBT**



Middle Capacity IPM

SCM1100M Series

New

Design Concept:

- Safe
- Reduction of external components count

Functions and Features

- Built-in pre-driver IC for each half-bridge
- Adapted high-side driver by bootstrap topology
- **Built-in bootstrap diode (protection diode against inrush current)**
- Built-in protection circuit for protection from high/low simultaneous ON (STP) (when simultaneous ON signal inputted)
- Built-in overcurrent protection circuit (OCP) (Stop high & low)
- Stop-time variable function during overcurrent protect operation (by external condenser)
- Built-in protection circuit for control power supply voltage reduction (UVLO, auto regression)
- Failure signal output during protection / CMOS circuit operation (UVLO (low side), during OCP&STP operation), corresponding 3.3V, 5V input level
- Minimize design for output penetrating current (Optimize gate resistance)
- DIP type power package

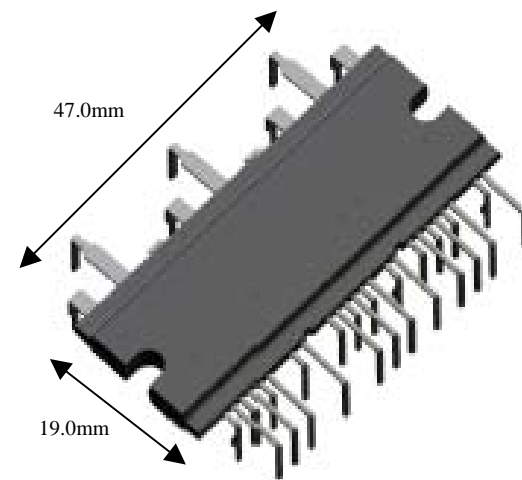



Middle Capacity IPM

SCM1100M Series Features

Built-in Bootstrap Diode

- As bootstrap diode (high voltage) is built-in, simple pattern design is possible (by reducing component count, which requires adequate creepage distance)
- Further reduction on component count by including inrush current absorbing resistor

Built-in protection circuit against high/low simultaneous ON (Shoot Through Prevention)

- By employing pre-driver for each half-bridge, prevent high/low simultaneous ON due to wrong command signal input or external noise.
- It realizes safer design

Short input-dead-time

- Embed pre-driver for each half-bridge and by doing so:
- Switching speed of high/low side is optimized
- Stable control is achieved



Middle Capacity IPM

SCM1100M Series Features (Cont.)

Arm-complete-stop (High & Low Side Gate Off) during overcurrent protection mode

- Embed pre-driver for each half-bridge, and by doing so:
- Avoid consecutive short-circuit mode when protection mode is released.
- Realizes safer design

Soft Off at shutoff by overcurrent protection

- Soft turn-off at shutoff in overcurrent protection
- Minimize negative voltage occurred in LS terminal (by restraining di/dt)
- Failure protection of IPM by negative voltage and of external current sense circuit
- Realizes safer design

Arm-complete-stop (3 Arms Gate Off) is possible during protection mode

- By connecting 3 fail signal output terminals externally, it enables to stop whole IPM *FO terminal is also used as enable input
- Avoid consecutive short-circuit mode when protection mode is released
- Realizes safer design



Middle Capacity IPM

SCM1100M Series Line-up

Products	Power device	Voltage	Current	Vsat (Speed)	Protection	Status
SCM1101M	IGBT	600V	10A	1.6V typ. (Low)	UVLO, OCP	MP
SCM1103M	IGBT	600V	5A	1.6V typ. (Low)	UVLO, OCP	MP
SCM1104M	IGBT	600V	8A	1.6V typ. (Low)	UVLO, OCP	MP
SCM1105MF	IGBT	600V	15A	1.6V typ. (Low)	UVLO, OCP	MP
SCM1106M	IGBT	600V	10A	2.2V typ. (High)	UVLO, OCP	MP
SCM1110MF	IGBT	600V	15A	2.2V typ. (High)	UVLO, OCP	MP



IPM Advantages vs. Discrete Solution

- PCB space reduction (compact design)
- Lower failure rate (less components and solder joints)
- Lower solution cost
 - IPM protection circuitry is complex to implement with discrete components
 - Smaller PCB
 - Smaller heatsink
 - Less assembly
 - Reduction of design time
- Shorter time to market
- Proven design
 - Already used in the field for many products
 - Design effort is minimum, just copy the application circuit
 - Not need to worry about gate resistors, trip circuitry and drive configuration
- Switching optimized for lower EMC noise



Sanken IPM advantages vs. Competitor IPM

- Improved protection functions (cross coupling prevention logic, soft-off, etc.)
- Lower thermal resistance
- Allegro/Sanken can support the design locally in terms of hardware & software:
 - Co-work with customers for board adjustments
 - Assist customer with EMI measurements
 - Support customer during software development
 - Knowledge transfer