

REVISIONS				
REV.	ECO. NO	DESCRIPTION	DATE	BY
D	556	UPDATE PRINT TO BE FOR SULLINS CUSTOMERS ONLY. SHOW ONLY CUSTOMER REQUIREMENTS	3/2/2005	MNH
E	669	ADDED UP TO 100 POSITIONS	7/5/2005	TT
F	880	UPDATED FORMAT	3/21/2006	MNH
G	1496	ADDED HEADER TO FOURTH ROW, TABULATED MATERIAL	3/18/2008	VJ
H	2475	ADDED POSI # TO 100, UPDATED DIM A (WAS A1 & A2), INSPECTION NOTE 16 & 17, DIM SIDE MTG HOLES TO TOP INSULATOR EDGE, CONTACT GAP $.030 \pm .010$, INSERTION FORCE 8OZ, PROCESSING TIME 20 SEC FOR 'G' & 'J' MTL	10/20/2011	JH
J	3028	UPDATE INSERT FROM FAR SIDE ON 'A' MOUNTING	7/30/2014	JHSU

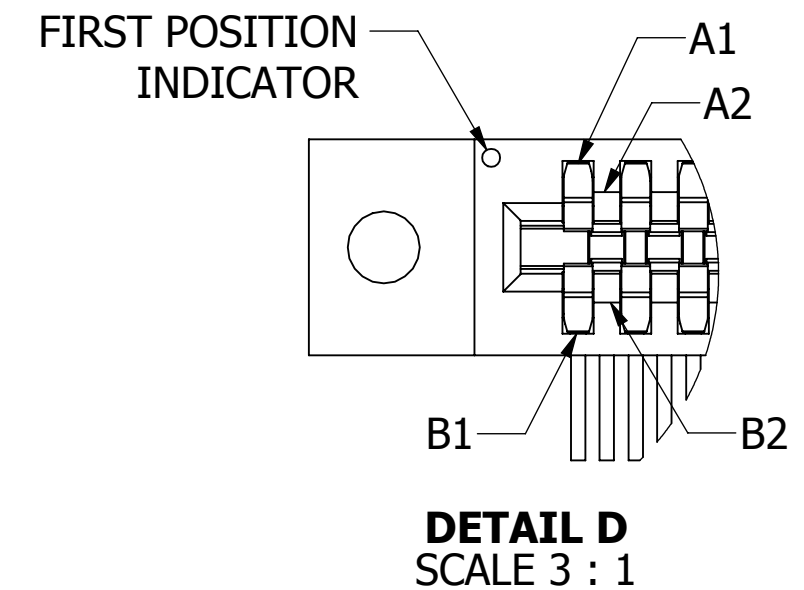

- NOTES:
- INSULATOR MATERIAL: SEE PART NUMBER CODING
 - CONTACT MATERIAL: SEE PART NUMBER CODING
 - PLATING: SEE PART NUMBER CODING
 - OPERATING TEMPERATURE: SEE PART NUMBER CODING
 - PROCESSING TEMP: SEE PART NUMBER CODING
 - UL FLAMMABILITY RATING: 94V-0
 - OPERATING VOLTAGE: 225 VAC MINIMUM AT SEA LEVEL
 - CURRENT RATING: 3 AMP
 - CONTACT RESISTANCE: 30 MILLI OHMS MAX
 - INSULATION RESISTANCE: 5000 MEGA OHMS
 - DURABILITY: 500 CYCLES MIN
 - CONNECTOR IDENTIFICATION: THE PART SHALL BE MARKED WITH A PART NUMBER AND LOT CODE
 - BOARD THICKNESS ACCOMMODATED: $.062 \pm .008 [1.57 \pm 0.20]$
 - INSERTION FORCE: 8 OZ MAX PER CONTACT PAIR WHEN USING A $.062 [1.57]$ TEST BLADE
 - WITHDRAWAL FORCE: 1 OZ MIN PER CONTACT PAIR USING $.062 [1.57]$ PCB

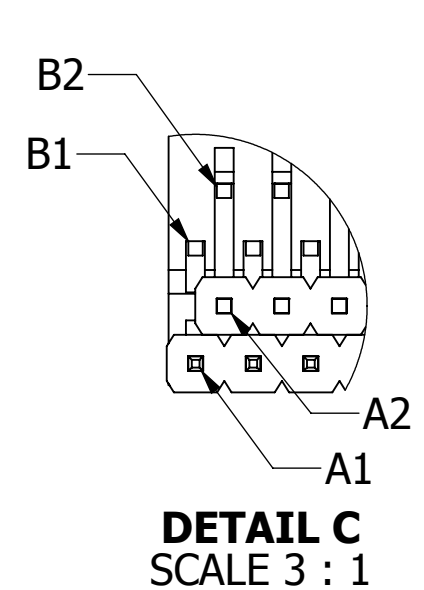
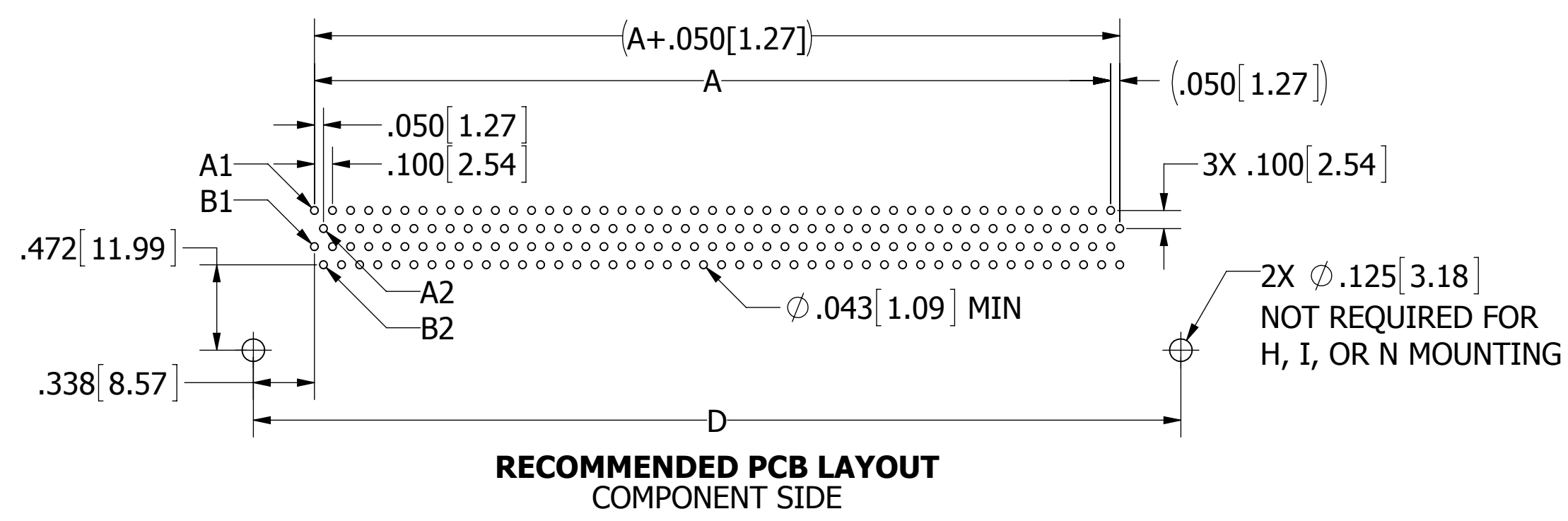
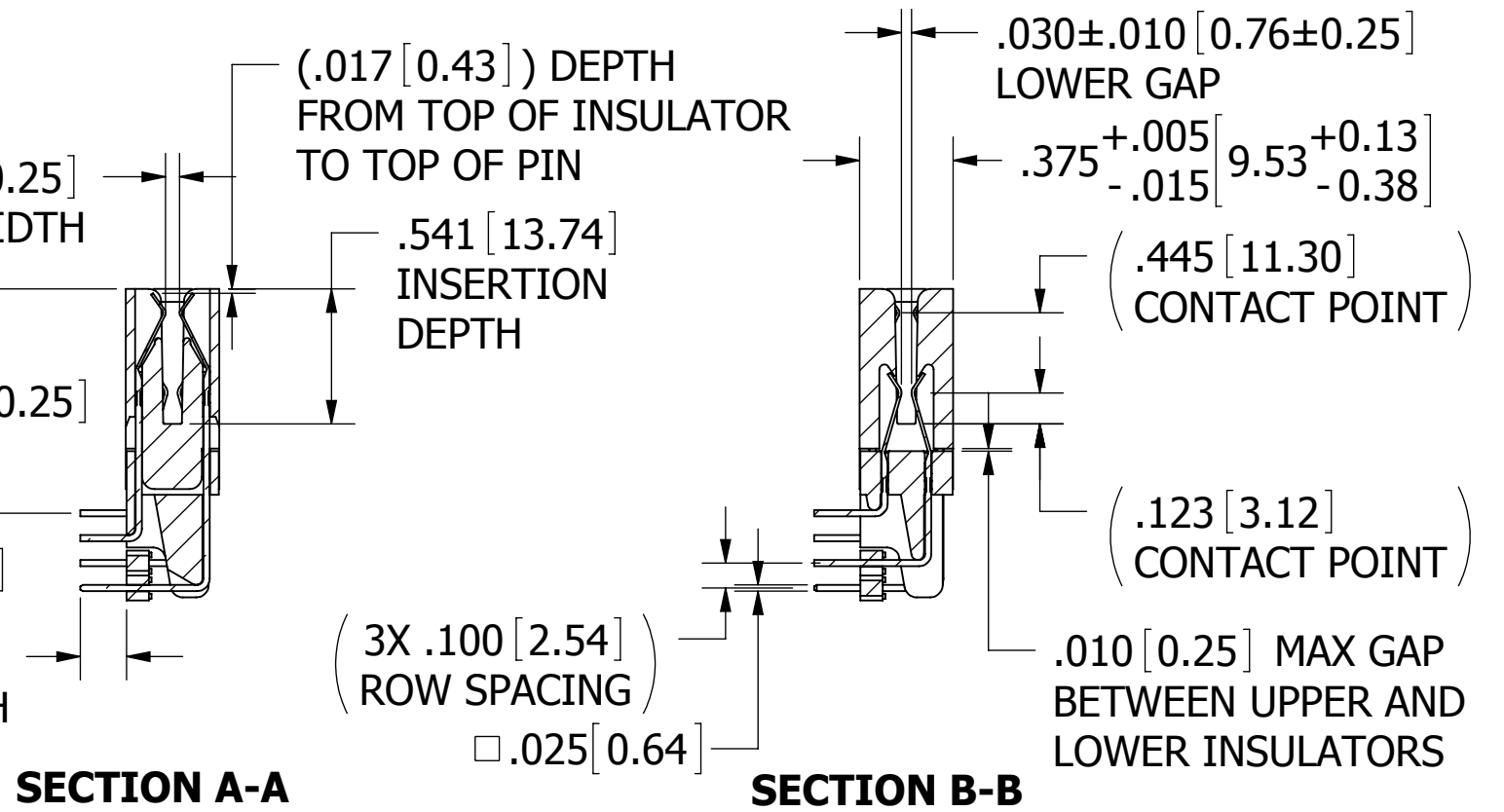
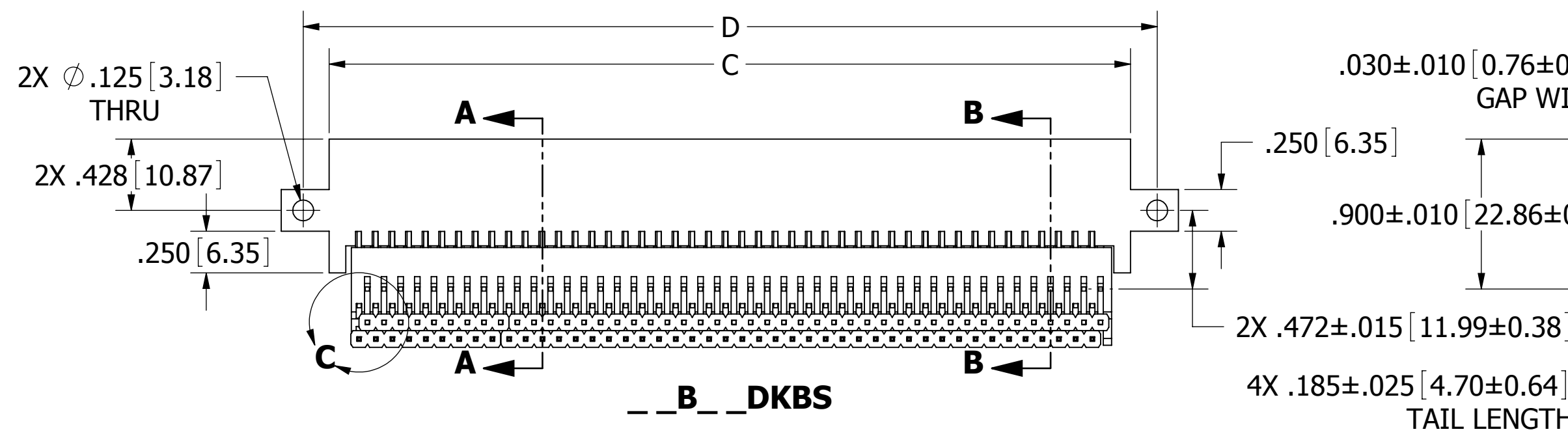
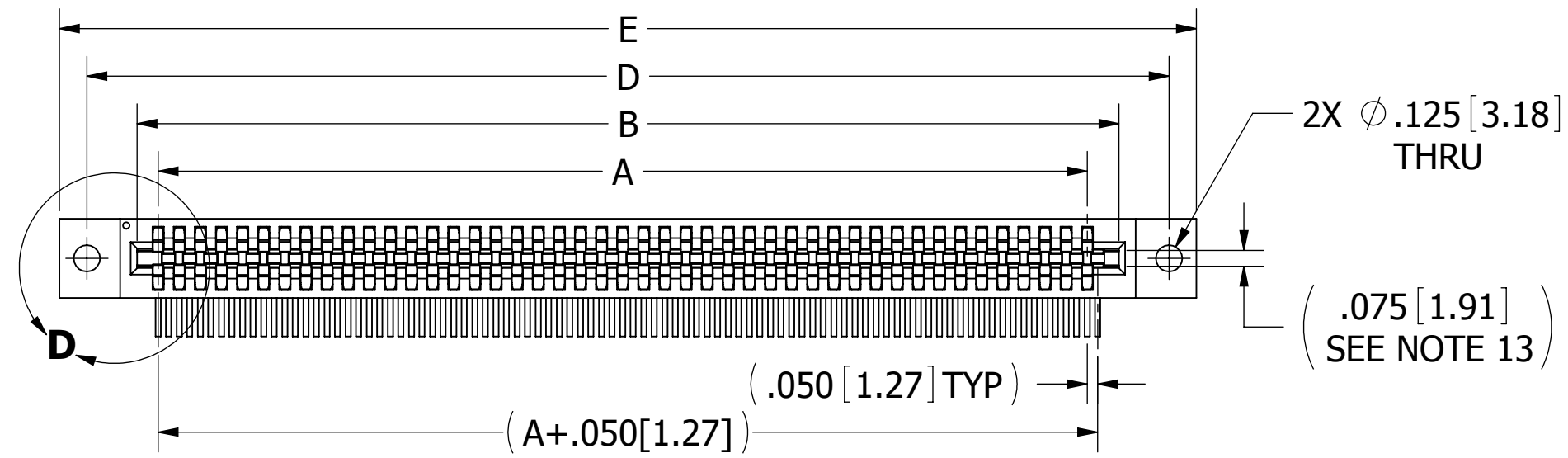

CUSTOMER COPY

UNLESS OTHERWISE SPECIFIED: DIMENSIONS ARE IN INCHES [MM]	DRAWN	DATE	NAME	
		5/24/2005	MNH	
TOLERANCES: ANGULAR: $\pm 1^\circ$ DECIMALS .XX = $\pm .02 [.5]$.XXX = $\pm .005 [.13]$.XXXX = $\pm .0005 [.013]$	<small>THE INFORMATION HEREIN CONTAINS PROPRIETARY INFORMATION OF SULLINS ELECTRONICS AND IS NOT TO BE REPRODUCED, USED OR DISCLOSED TO OTHERS FOR ANY PURPOSE EXCEPT AS SPECIFICALLY AUTHORIZED IN WRITING BY AN OFFICER OF SULLINS ELECTRONICS.</small>			TITLE
				BI-LEVEL, .050 CC, RAB
PART NUMBER				
__B__DKB__				
SIZE	CAGE CODE	DWG. NO.	REV	
C	54453	C10214	J	
SCALE: 2:1.5		SHEET 1 OF 4		

8 7 6 5 4 3 2 1

F
E
D
C
B
A

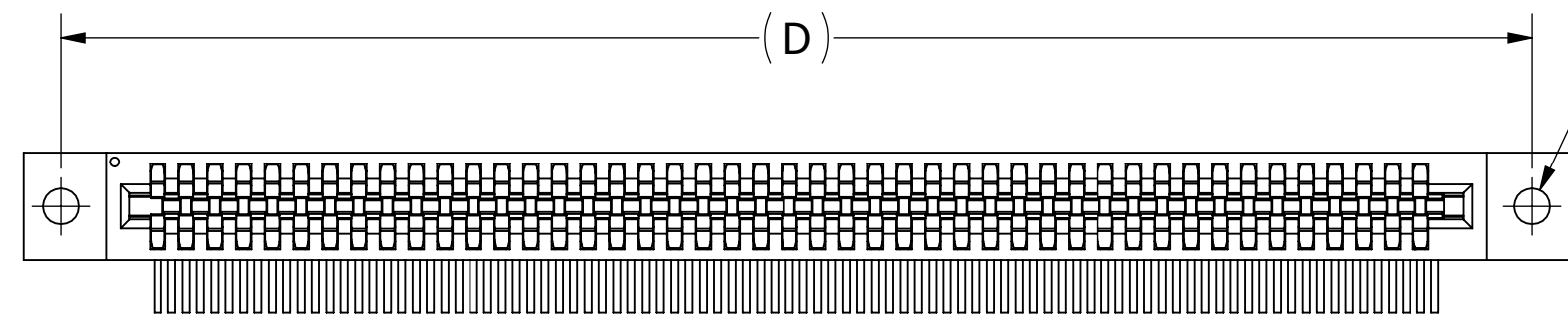

2X ϕ .125 [3.18]
THRU

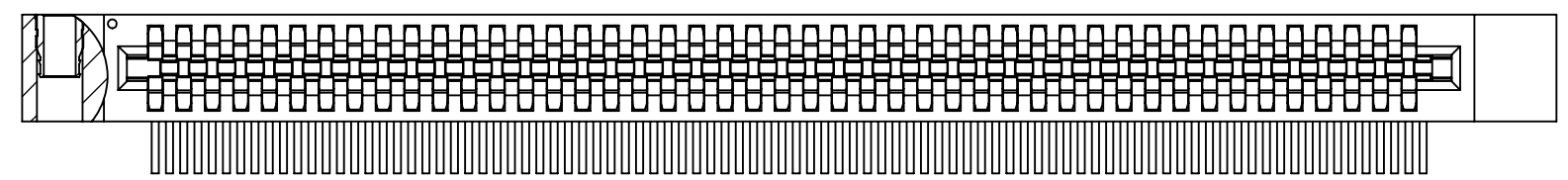

2X #4-40
THREADED INSERT
(FROM FAR SIDE)

2X .428 [10.87]

2X .472±.015 [11.99±0.38]

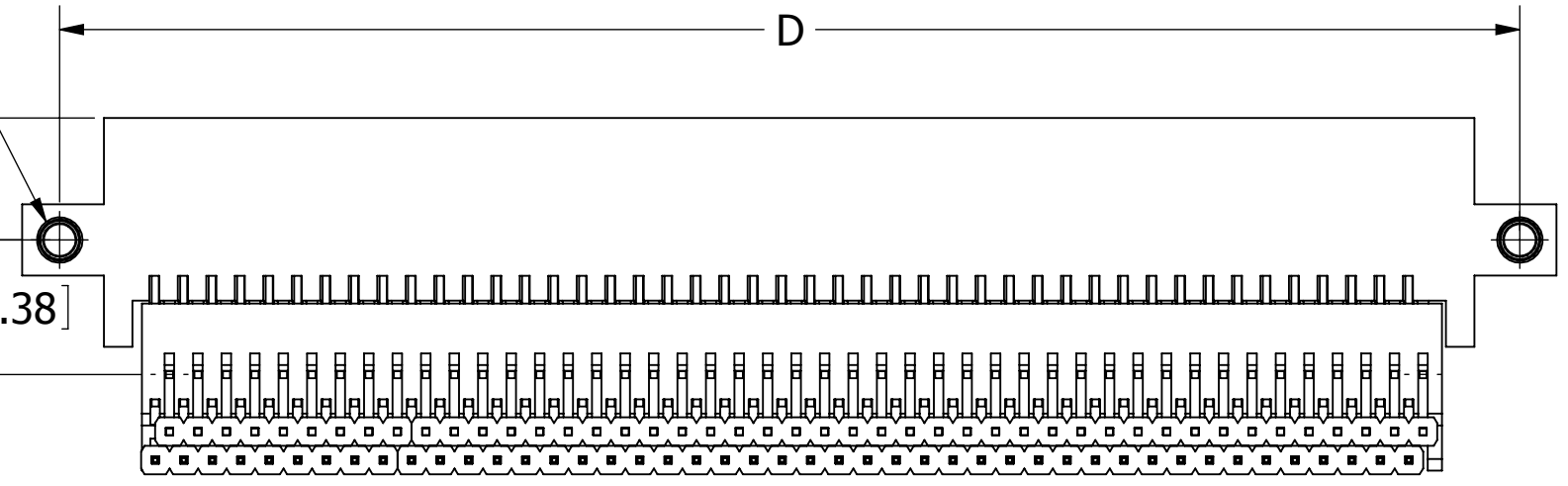
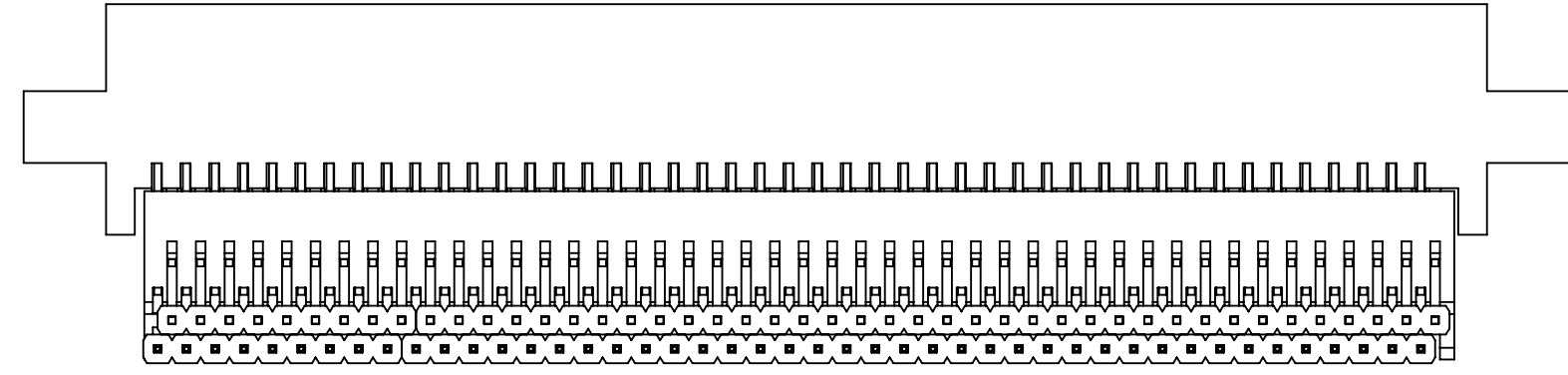

__B__DKBH

__B__DKBA

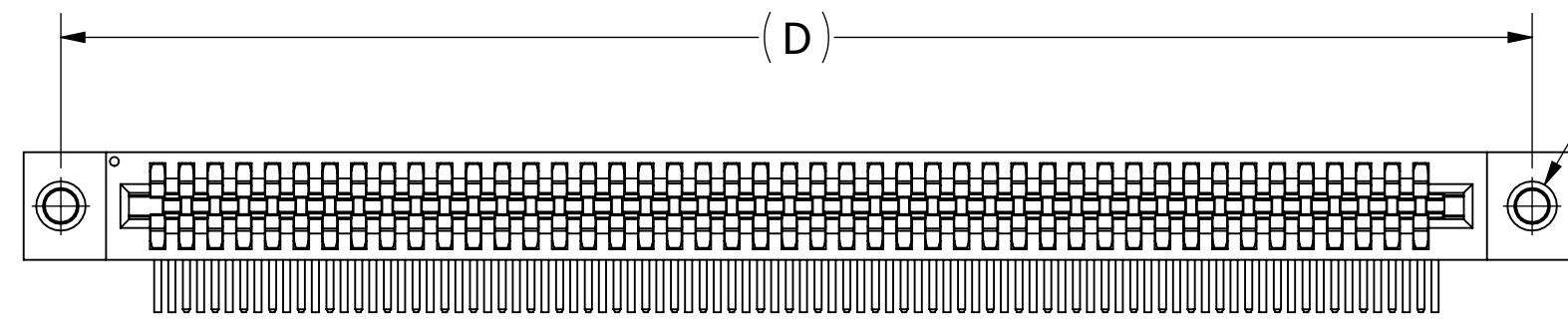

2X #4-40
THREADED
INSERTS

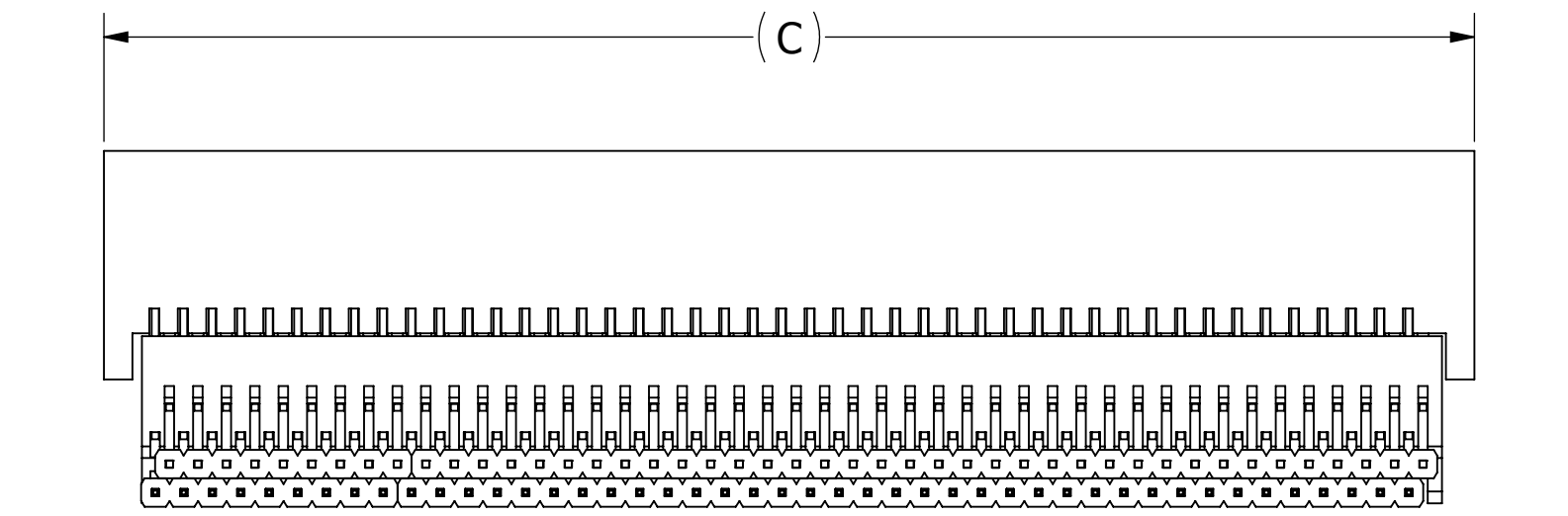
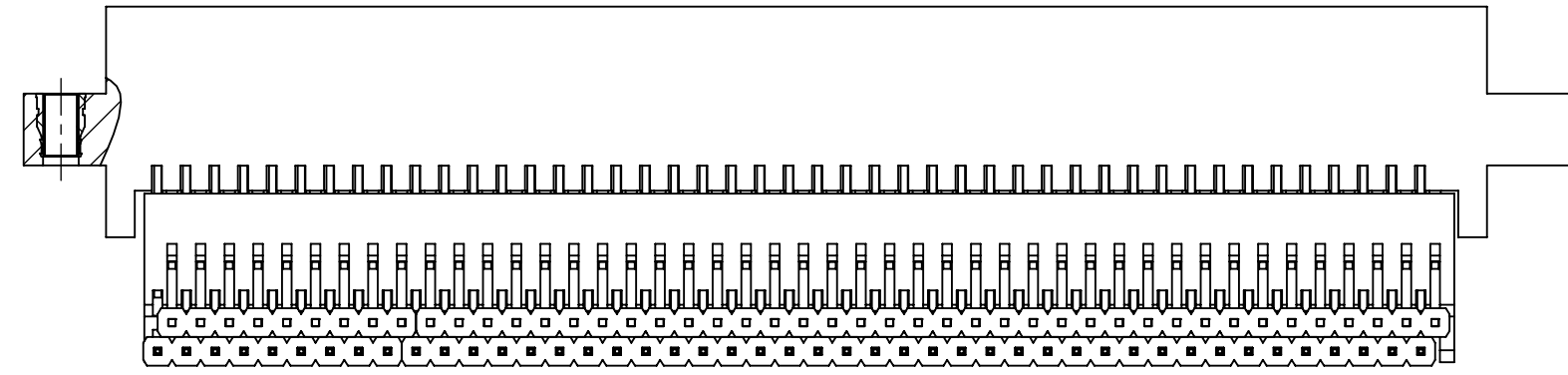
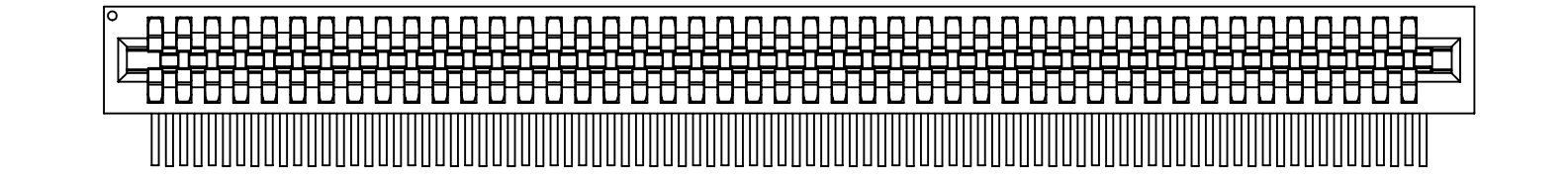

__B__DKBI

__B__DKBN

CUSTOMER COPY



UNLESS OTHERWISE SPECIFIED:
DIMENSIONS ARE IN INCHES [MM]

TOLERANCES:
ANGULAR: $\pm 1^\circ$

DECIMALS
.XX = $\pm .02$ [.5]
.XXX = $\pm .005$ [.13]
.XXXX = $\pm .0005$ [.013]

DRAWN	DATE	NAME
	5/24/2005	MNH
<small>THE INFORMATION HEREIN CONTAINS PROPRIETARY INFORMATION OF SULLINS ELECTRONICS AND IS NOT TO BE REPRODUCED, USED OR DISCLOSED TO OTHERS FOR ANY PURPOSE EXCEPT AS SPECIFICALLY AUTHORIZED IN WRITING BY AN OFFICER OF SULLINS ELECTRONICS.</small>		



TITLE		BI-LEVEL, .050 CC, RAB	
PART NUMBER		__B__DKB__	
SIZE	CAGE CODE	DWG. NO.	REV
C	54453	C10214	J
SCALE: 2:1.5		SHEET 2 OF 4	

8 7 6 5 4 3 2 1

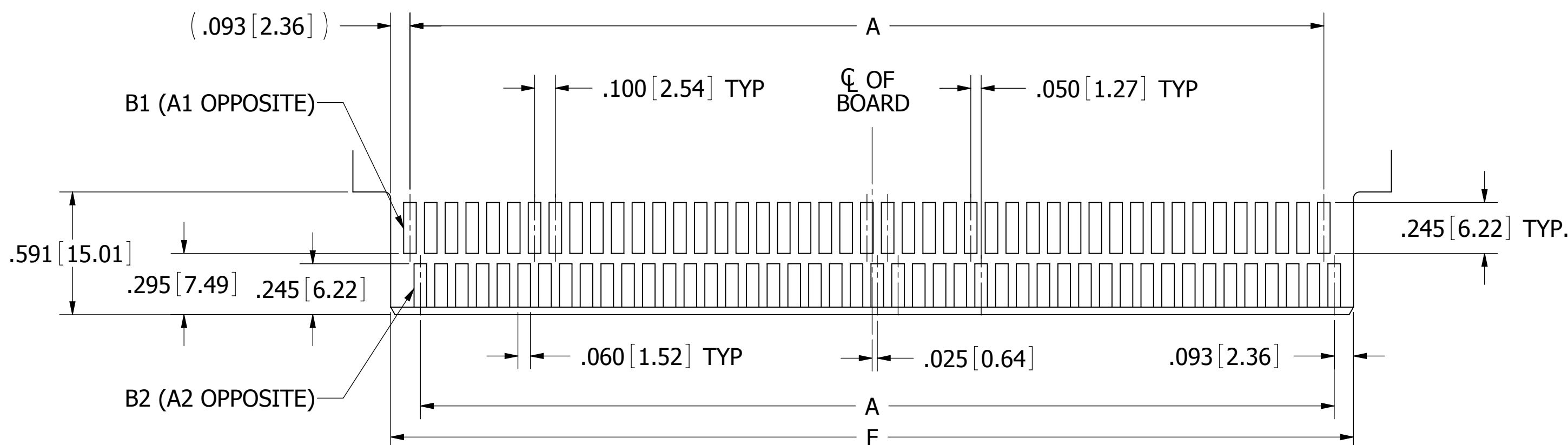

DAUGHTER CARD LAYOUT NUMBER 1
 90 POSITION SHOWN
 REFER TO PAGE 4 TO DETERMINE LAYOUT TO USE

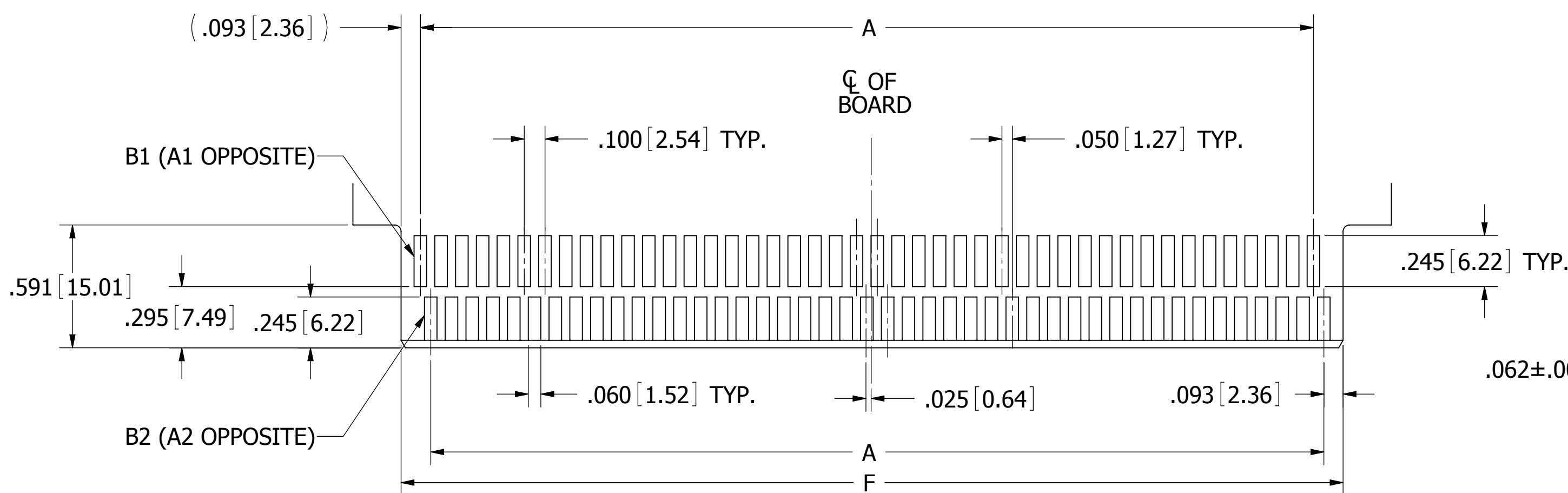

DAUGHTER CARD LAYOUT NUMBER 2
 88 POSITION SHOWN
 REFER TO PAGE 4 TO DETERMINE LAYOUT TO USE

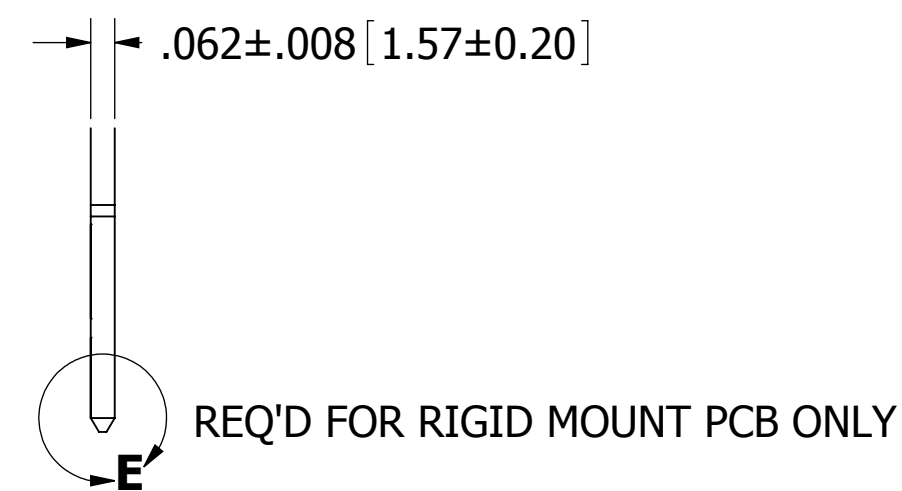

CUSTOMER COPY



RoHS COMPLIANT

UNLESS OTHERWISE SPECIFIED:
 DIMENSIONS ARE IN INCHES [MM]

TOLERANCES:

ANGULAR: ± 1°

DECIMALS
 .XX=± .02 [.5]
 .XXX=± .005 [.13]
 .XXXX=± .0005 [.013]

DRAWN	DATE	NAME
	5/24/2005	MNH

THE INFORMATION HEREIN CONTAINS PROPRIETARY INFORMATION OF SULLINS ELECTRONICS AND IS NOT TO BE REPRODUCED, USED OR DISCLOSED TO OTHERS FOR ANY PURPOSE EXCEPT AS SPECIFICALLY AUTHORIZED IN WRITING BY AN OFFICER OF SULLINS ELECTRONICS.



TITLE
 BI-LEVEL, .050 CC, RAB

PART NUMBER
 __B__DKB__

SIZE	CAGE CODE	DWG. NO.	REV
C	54453	C10214	J

SCALE: 2:1 SHEET 3 OF 4

PART NUMBER	POS	INCHES						POS	MILLIMETERS						DAUGHTER CARD LAYOUT
		A±.005	B±.005	C±.015	D±.010	E±.020	F		A±0.13	B±0.13	C±0.38	D±0.25	E±0.51	F	
B06DKB	6	0.200	0.450	0.610	0.925	1.185	0.436	6	5.08	11.43	15.49	23.50	30.10	11.07	1
B08DKB	8	0.300	0.550	0.710	1.025	1.285	0.536	8	7.62	13.97	18.03	26.04	32.64	13.61	2
B10DKB	10	0.400	0.650	0.810	1.125	1.385	0.636	10	10.16	16.51	20.57	28.58	35.18	16.15	1
B12DKB	12	0.500	0.750	0.910	1.225	1.485	0.736	12	12.70	19.05	23.11	31.12	37.72	18.69	2
B14DKB	14	0.600	0.850	1.010	1.325	1.585	0.836	14	15.24	21.59	25.65	33.66	40.26	21.23	1
B16DKB	16	0.700	0.950	1.110	1.425	1.685	0.936	16	17.78	24.13	28.19	36.20	42.80	23.77	2
B18DKB	18	0.800	1.050	1.210	1.525	1.785	1.036	18	20.32	26.67	30.73	38.74	45.34	26.31	1
B20DKB	20	0.900	1.150	1.310	1.625	1.885	1.136	20	22.86	29.21	33.27	41.28	47.88	28.85	2
B22DKB	22	1.000	1.250	1.410	1.725	1.985	1.236	22	25.40	31.75	35.81	43.82	50.42	31.39	1
B24DKB	24	1.100	1.350	1.510	1.825	2.085	1.336	24	27.94	34.29	38.35	46.36	52.96	33.93	2
B26DKB	26	1.200	1.450	1.610	1.925	2.185	1.436	26	30.48	36.83	40.89	48.90	55.50	36.47	1
B28DKB	28	1.300	1.550	1.710	2.025	2.285	1.536	28	33.02	39.37	43.43	51.44	58.04	39.01	2
B30DKB	30	1.400	1.650	1.810	2.125	2.385	1.636	30	35.56	41.91	45.97	53.98	60.58	41.55	1
B32DKB	32	1.500	1.750	1.910	2.225	2.485	1.736	32	38.10	44.45	48.51	56.52	63.12	44.09	2
B34DKB	34	1.600	1.850	2.010	2.325	2.585	1.836	34	40.64	46.99	51.05	59.06	65.66	46.63	1
B36DKB	36	1.700	1.950	2.110	2.425	2.685	1.936	36	43.18	49.53	53.59	61.60	68.20	49.17	2
B38DKB	38	1.800	2.050	2.210	2.525	2.785	2.036	38	45.72	52.07	56.13	64.14	70.74	51.71	1
B40DKB	40	1.900	2.150	2.310	2.625	2.885	2.136	40	48.26	54.61	58.67	66.68	73.28	54.25	2
B42DKB	42	2.000	2.250	2.410	2.725	2.985	2.236	42	50.80	57.15	61.21	69.22	75.82	56.79	1
B44DKB	44	2.100	2.350	2.510	2.825	3.085	2.336	44	53.34	59.69	63.75	71.76	78.36	59.33	2
B46DKB	46	2.200	2.450	2.610	2.925	3.185	2.436	46	55.88	62.23	66.29	74.30	80.90	61.87	1
B48DKB	48	2.300	2.550	2.710	3.025	3.285	2.536	48	58.42	64.77	68.83	76.84	83.44	64.41	2
B50DKB	50	2.400	2.650	2.810	3.125	3.385	2.636	50	60.96	67.31	71.37	79.38	85.98	66.95	1
B52DKB	52	2.500	2.750	2.910	3.225	3.485	2.736	52	63.50	69.85	73.91	81.92	88.52	69.49	2
B54DKB	54	2.600	2.850	3.010	3.325	3.585	2.836	54	66.04	72.39	76.45	84.46	91.06	72.03	1
B56DKB	56	2.700	2.950	3.110	3.425	3.685	2.936	56	68.58	74.93	78.99	87.00	93.60	74.57	2
B58DKB	58	2.800	3.050	3.210	3.525	3.785	3.036	58	71.12	77.47	81.53	89.54	96.14	77.11	1
B60DKB	60	2.900	3.150	3.310	3.625	3.885	3.136	60	73.66	80.01	84.07	92.08	98.68	79.65	2
B62DKB	62	3.000	3.250	3.410	3.725	3.985	3.236	62	76.20	82.55	86.61	94.62	101.22	82.19	1
B64DKB	64	3.100	3.350	3.510	3.825	4.085	3.336	64	78.74	85.09	89.15	97.16	103.76	84.73	2
B66DKB	66	3.200	3.450	3.610	3.925	4.185	3.436	66	81.28	87.63	91.69	99.70	106.30	87.27	1
B68DKB	68	3.300	3.550	3.710	4.025	4.285	3.536	68	83.82	90.17	94.23	102.24	108.84	89.81	2
B70DKB	70	3.400	3.650	3.810	4.125	4.385	3.636	70	86.36	92.71	96.77	104.78	111.38	92.35	1
B72DKB	72	3.500	3.750	3.910	4.225	4.485	3.736	72	88.90	95.25	99.31	107.32	113.92	94.89	2
B74DKB	74	3.600	3.850	4.010	4.325	4.585	3.836	74	91.44	97.79	101.85	109.86	116.46	97.43	1
B76DKB	76	3.700	3.950	4.110	4.425	4.685	3.936	76	93.98	100.33	104.39	112.40	119.00	99.97	2
B78DKB	78	3.800	4.050	4.210	4.525	4.785	4.036	78	96.52	102.87	106.93	114.94	121.54	102.51	1
B80DKB	80	3.900	4.150	4.310	4.625	4.885	4.136	80	99.06	105.41	109.47	117.48	124.08	105.05	2
B82DKB	82	4.000	4.250	4.410	4.725	4.985	4.236	82	101.60	107.95	112.01	120.02	126.62	107.59	1
B84DKB	84	4.100	4.350	4.510	4.825	5.085	4.336	84	104.14	110.49	114.55	122.56	129.16	110.13	2
B86DKB	86	4.200	4.450	4.610	4.925	5.185	4.436	86	106.68	113.03	117.09	125.10	131.70	112.67	1
B88DKB	88	4.300	4.550	4.710	5.025	5.285	4.536	88	109.22	115.57	119.63	127.64	134.24	115.21	2
B90DKB	90	4.400	4.650	4.810	5.125	5.385	4.636	90	111.76	118.11	122.17	130.18	136.78	117.75	1
B92DKB	92	4.500	4.750	4.910	5.225	5.485	4.736	92	114.30	120.65	124.71	132.72	139.32	120.29	2
B94DKB	94	4.600	4.850	5.010	5.325	5.585	4.836	94	116.84	123.19	127.25	135.26	141.86	122.83	1
B96DKB	96	4.700	4.950	5.110	5.425	5.685	4.936	96	119.38	125.73	129.79	137.80	144.40	125.37	2
B98DKB	98	4.800	5.050	5.210	5.525	5.785	5.036	98	121.92	128.27	132.33	140.34	146.94	127.91	1
B100DKB	100	4.900	5.150	5.310	5.625	5.885	5.136	100	124.46	130.81	134.87	142.88	149.48	130.45	2

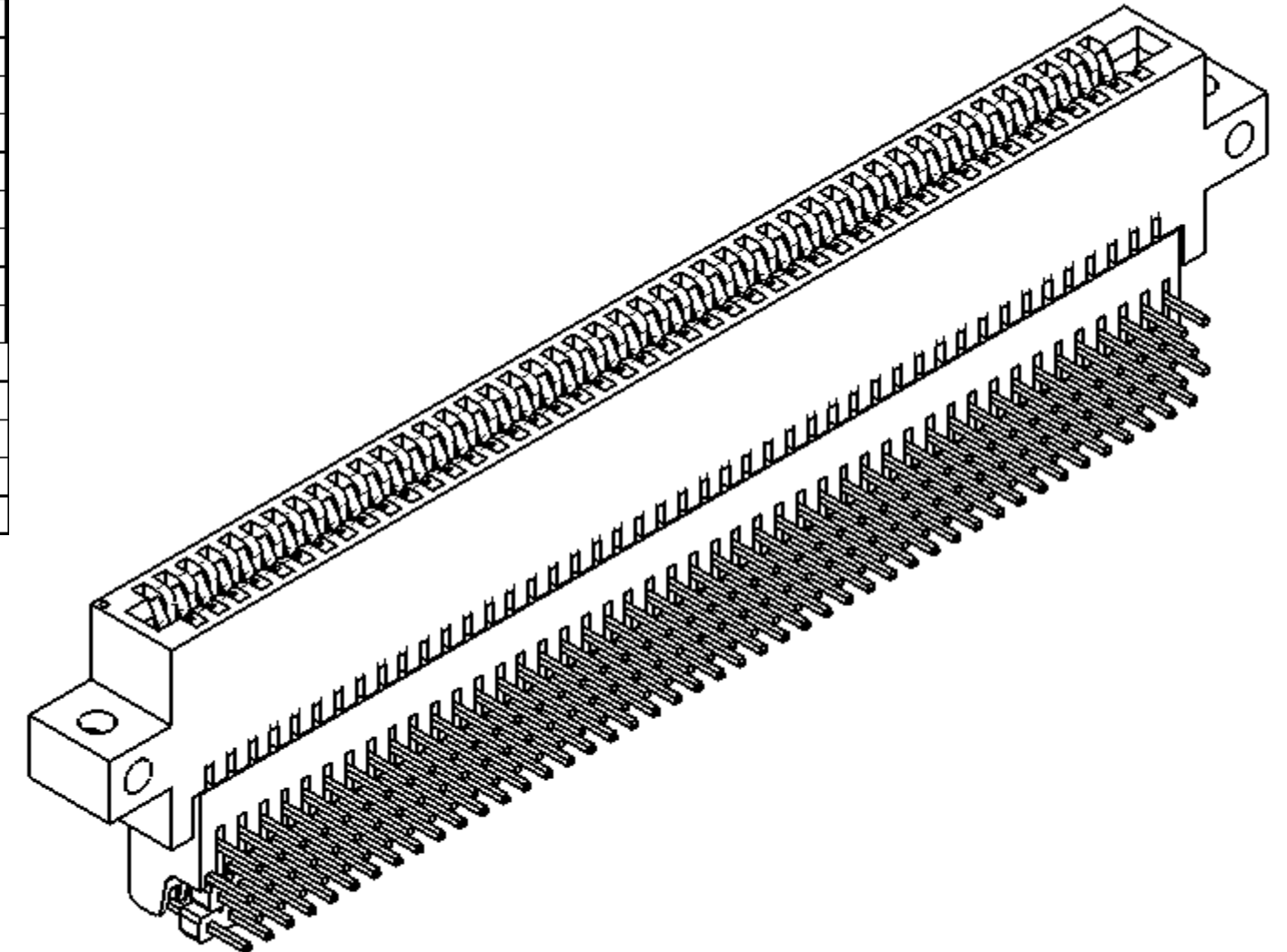

PART NUMBER CODING

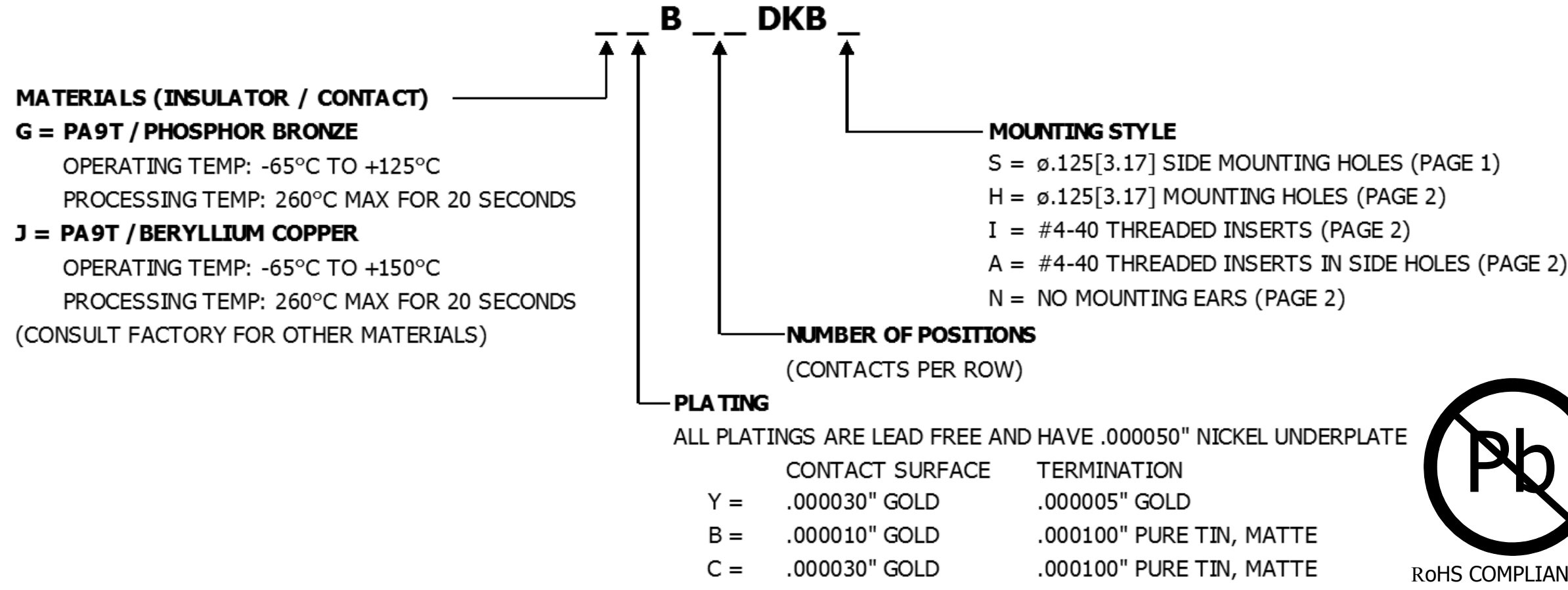

CUSTOMER COPY

UNLESS OTHERWISE SPECIFIED: DIMENSIONS ARE IN INCHES (MM)		DRAWN	DATE	NAME	
			5/24/2005	MNH	
TOLERANCES:					<small>THE INFORMATION HEREIN CONTAINS PROPRIETARY INFORMATION OF SULLINS ELECTRONICS AND IS NOT TO BE REPRODUCED, USED OR DISCLOSED TO OTHERS FOR ANY PURPOSE EXCEPT AS SPECIFICALLY AUTHORIZED IN WRITING BY AN OFFICER OF SULLINS ELECTRONICS.</small>
ANGULAR: ± 1°					
DECIMALS .XX = ± .02 [.5] .XXX = ± .005 [.13] .XXXX = ± .0005 [.013]					
TITLE					BI-LEVEL, .050 CC, RAB
PART NUMBER					_ B _ DKB _
SIZE	CAGE CODE	DWG. NO.	REV		
C	54453	C10214	J		
SCALE: 2:1					SHEET 4 OF 4