

BEF-KHS-N05N

Mounting systems

ACCESSORIES

SICK
Sensor Intelligence.



Ordering information

Type	Part no.
BEF-KHS-N05N	2051621

Other models and accessories → www.sick.com/Mounting_systems

Detailed technical data

Technical specifications

Accessory group	Universal bar clamp systems
Material	Stainless steel 1.4571 (sheet), Stainless steel 1.4408 (clamp)
Items supplied	Universal clamp (5322626), mounting hardware
Description	Plate N05N for universal clamp bracket, M12

Classifications

ECl@ss 5.0	27279202
ECl@ss 5.1.4	27279202
ECl@ss 6.0	27279202
ECl@ss 6.2	27279202
ECl@ss 7.0	27279202
ECl@ss 8.0	27279202
ECl@ss 8.1	27279202
ECl@ss 9.0	27273701
ETIM 5.0	EC002024
ETIM 6.0	EC002024
UNSPSC 16.0901	32131023

Dimensional drawing (Dimensions in mm (inch))

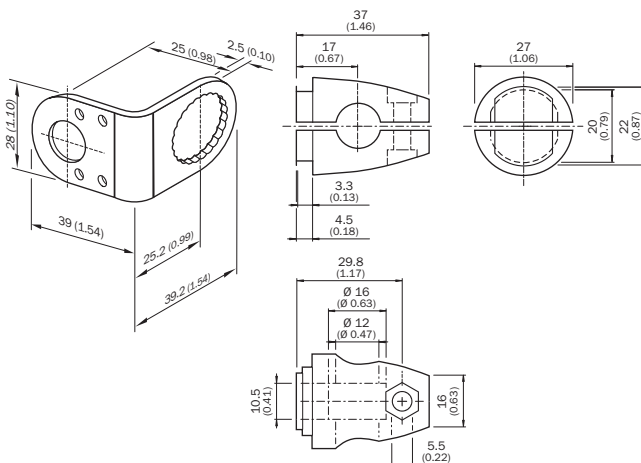

Recommended accessories

Other models and accessories → www.sick.com/Mounting_systems

Brief description	Type	Part no.
Universal bar clamp systems		
Universal clamp bracket for mounting bars with 12 mm diameter, Stainless steel V2A (1.4301), without mounting hardware	BEF-KHS-KH3N	5322627
Ring to connect two bar clamps 12 mm (bar clamp 5322627), Stainless steel 1.4404, Ring to connect two bar clamps (bar clamps not included)	BEF-KHS-VRN	4075320
Mounting bar, straight, 300 mm, stainless steel, Stainless steel (1.4571)	BEF-MS12G-NB	4058915
Bar clamp for bar diameter of 12 mm (fixing the mounting rod), Aluminum, 2 screws M6 x 30, 2 spring discs	BEF-RMC-D12	5321878

SICK AT A GLANCE

SICK is one of the leading manufacturers of intelligent sensors and sensor solutions for industrial applications. A unique range of products and services creates the perfect basis for controlling processes securely and efficiently, protecting individuals from accidents and preventing damage to the environment.

We have extensive experience in a wide range of industries and understand their processes and requirements. With intelligent sensors, we can deliver exactly what our customers need. In application centers in Europe, Asia and North America, system solutions are tested and optimized in accordance with customer specifications. All this makes us a reliable supplier and development partner.

Comprehensive services complete our offering: SICK LifeTime Services provide support throughout the machine life cycle and ensure safety and productivity.

For us, that is “Sensor Intelligence.”

WORLDWIDE PRESENCE:

Contacts and other locations –www.sick.com