

ESY, Aluminum Electrolytic, 105C LowZ, 270 uF, 20%, 63 VDC, -40/+105C, Lead Spacing = 5mm

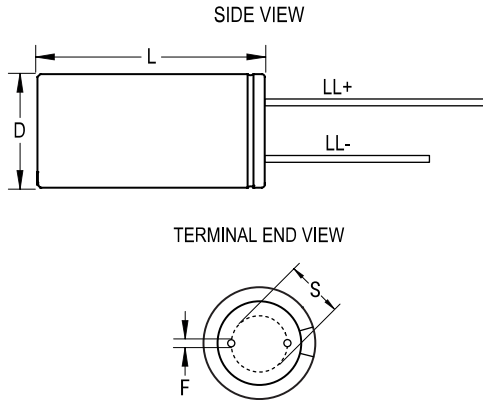

Dimensions

D	13mm +/-0.5mm
L	20mm +2mm
S	5mm +/-0.5mm
LL Negative	15mm MIN
LL Positive	20mm MIN
F	0.6mm NOM

Packaging Specifications

Packaging:	Bulk, Bag
Packaging Quantity:	2000

General Information

Supplier:	KEMET
Series:	ESY
Dielectric:	Aluminum Electrolytic
Description:	LowZ Single Ended Aluminum Electrolytic
Features:	Low Z
RoHS:	Yes
Lead:	Wire Leads

Specifications

Capacitance:	270 uF
Capacitance Tolerance:	20%
Voltage DC:	63 VDC, 79 VDC (Surge)
Temperature Range:	-40/+105C
Rated Temperature:	105C
Life:	5000 Hrs
Dissipation Factor:	9.00%
Resistance:	0.81 Ohms (100kHz)
Ripple Current:	1200 mAmps (100kHz 105C)
Leakage Current:	170.1 uA (2min 20C)
Impedance Ratio at -25C:	2
Impedance Ratio at -40C:	3