

## Reverse Gullwing SMD LED Red



### DESCRIPTION

This device has been designed to meet the increasing demand for AlInGaP technology.

It consists of a lead frame which is embedded in a white thermoplast. The reflector inside this package is filled up with clear epoxy.

LED is mounted top down and emits through the PCB.

### PRODUCT GROUP AND PACKAGE DATA

- Product group: LED
- Package: SMD reverse gullwing
- Product series: standard
- Angle of half intensity:  $\pm 60^\circ$

### FEATURES

- SMD LED with exceptional brightness
- Luminous intensity categorized
- Compatible with automatic placement equipment
- EIA and ICE standard package
- Compatible with IR reflow, vapor phase and wave solder processes according to CECC 00802 and J-STD-020C
- Available in 12 mm tape
- Low profile package
- Non-diffused lens: Excellent for coupling to light pipes and backlighting
- Low power consumption
- Luminous intensity ratio in one packaging unit  $I_{Vmax}/I_{Vmin} > 1.6$
- Preconditioning according to JEDEC level 2a
- ESD-withstand voltage: Up to 2 kV according to JESD22-A114-B
- AEC-Q101 qualified
- Material categorization: For definitions of compliance please see [www.vishay.com/doc?99912](http://www.vishay.com/doc?99912)

 AUTOMOTIVE  
GRADE

**RoHS**  
COMPLIANT  
HALOGEN  
**FREE**  
**GREEN**  
(5-2008)

### APPLICATIONS

- Automotive: Backlighting in dashboards and switches
- Telecommunication: Indicator and backlighting in telephone and fax
- Indicator and backlight for audio and video equipment
- Indicator and backlight in office equipment
- Flat backlight for LCDs, switches, and symbols
- General use

PARTS TABLE														
PART	COLOR	LUMINOUS INTENSITY (mcd)			at I <sub>F</sub> (mA)	WAVELENGTH (nm)			at I <sub>F</sub> (mA)	FORWARD VOLTAGE (V)			at I <sub>F</sub> (mA)	TECHNOLOGY
		MIN.	TYP.	MAX.		MIN.	TYP.	MAX.		MIN.	TYP.	MAX.		
VLRK31R1S2-GS08	Red	112	-	285	20	620	630	635	20	-	2.1	2.3	20	AllInGaP on GaAs
VLRK31R1S2-GS18	Red	112	-	285	20	620	630	635	20	-	2.1	2.3	20	AllInGaP on GaAs
VLRK31Q1R2-GS08	Red	71	-	180	20	620	630	635	20	-	2.1	2.3	20	AllInGaP on GaAs
VLRK31Q1R2-GS18	Red	71	-	180	20	620	630	635	20	-	2.1	2.3	20	AllInGaP on GaAs
VLRK31R1R2-GS08	Red	112	-	180	20	620	630	635	20	-	2.1	2.3	20	AllInGaP on GaAs
VLRK31R1R2-GS18	Red	112	-	180	20	620	630	635	20	-	2.1	2.3	20	AllInGaP on GaAs
VLRK31Q2R1-GS08	Red	90	-	140	20	620	630	635	20	-	2.1	2.3	20	AllInGaP on GaAs
VLRK31Q2R1-GS18	Red	90	-	140	20	620	630	635	20	-	2.1	2.3	20	AllInGaP on GaAs



<b>ABSOLUTE MAXIMUM RATINGS</b> ( $T_{amb} = 25\text{ }^{\circ}\text{C}$ , unless otherwise specified)				
<b>VLRK31..</b>				
PARAMETER	TEST CONDITION	SYMBOL	VALUE	UNIT
Reverse voltage <sup>(1)</sup>		$V_R$	5	V
DC forward current	$T_{amb} \leq 85\text{ }^{\circ}\text{C}$	$I_F$	30	mA
Surge forward current	$t_p \leq 10\text{ }\mu\text{s}$	$I_{FSM}$	1	A
Power dissipation		$P_V$	75	mW
Junction temperature		$T_j$	+ 125	$^{\circ}\text{C}$
Operating temperature range		$T_{amb}$	- 40 to + 100	$^{\circ}\text{C}$
Storage temperature range		$T_{stg}$	- 40 to + 100	$^{\circ}\text{C}$
Thermal resistance junction/ambient	mounted on PC board (pad size > 16 mm <sup>2</sup> )	$R_{thJA}$	400	K/W

**Note**

<sup>(1)</sup> Driving LED in reverse direction is suitable for short term application

<b>OPTICAL AND ELECTRICAL CHARACTERISTICS</b> ( $T_{amb} = 25\text{ }^{\circ}\text{C}$ , unless otherwise specified)							
<b>VLRE31.., YELLOW</b>							
PARAMETER	TEST CONDITION	PART	SYMBOL	MIN.	TYP.	MAX.	UNIT
Luminous intensity <sup>(1)</sup>	$I_F = 20\text{ mA}$	VLRK31R1S2	$I_V$	112	-	285	mcd
		VLRK31Q1R2	$I_V$	71	-	180	mcd
		VLRK31R1R2	$I_V$	112	-	180	mcd
		VLRK31Q2R1	$I_V$	90	-	140	mcd
Dominant wavelength <sup>(3)</sup>	$I_F = 20\text{ mA}$		$\lambda_d$	620	630	635	nm
Peak wavelength	$I_F = 20\text{ mA}$		$\lambda_p$	-	643	-	nm
Angle of half intensity	$I_F = 20\text{ mA}$		$\varphi$	-	$\pm 60$	-	deg
Forward voltage <sup>(2)</sup>	$I_F = 20\text{ mA}$		$V_F$	-	2.1	2.3	V
Reverse voltage	$I_R = 10\text{ }\mu\text{A}$		$V_R$	5	-	-	V
Junction capacitance	$V_R = 0\text{ V}$ , $f = 1\text{ MHz}$		$C_j$	-	15	-	pF

**Notes**

- <sup>(1)</sup> In one packing unit  $I_{Vmax}/I_{Vmin} > 1.6$   
<sup>(2)</sup> Forward voltages are tested at a current pulse duration of 1 ms and a tolerance of  $\pm 0.05\text{ V}$   
<sup>(3)</sup> Wavelengths are tested at a current pulse duration of 25 ms and an accuracy of  $\pm 1\text{ nm}$

<b>LUMINOUS INTENSITY CLASSIFICATION</b>			
GROUP	LUMINOUS INTENSITY $I_V$ (mcd)		
STANDARD	OPTIONAL	MIN.	MAX.
Q	1	71	90
	2	90	112
R	1	112	140
	2	140	180
S	1	180	224
	2	224	285

<b>CROSSING TABLE</b>	
VISHAY	OSRAM
VLRK31R1S2	LST776-R1S2
VLRK31Q1R2	LST776-Q1R2
VLRK31R1R2	LST776-R1R2
VLRK31Q2R1	LST776-Q2R1

**Note**

- Luminous intensity is tested at a current pulse duration of 25 ms and an accuracy of  $\pm 11\%$ .  
 The above type numbers represent the order groups which include only a few brightness groups. Only one group will be shipped on each reel (there will be no mixing of two groups on each reel).  
 In order to ensure availability, single brightness groups will not be orderable. In a similar manner for colors where wavelength groups are measured and binned, single wavelength groups will be shipped in any one reel.  
 In order to ensure availability, single wavelength groups will not be orderable.

**TYPICAL CHARACTERISTICS** ( $T_{amb} = 25\text{ }^{\circ}\text{C}$ , unless otherwise specified)

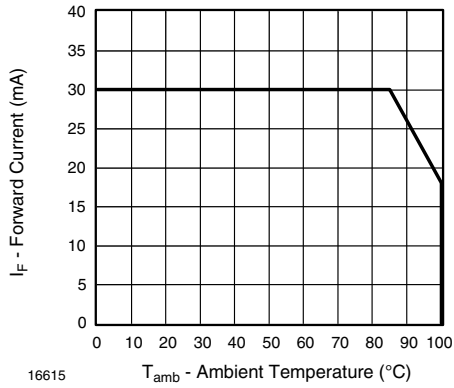

Fig. 1 - Forward Current vs. Ambient Temperature

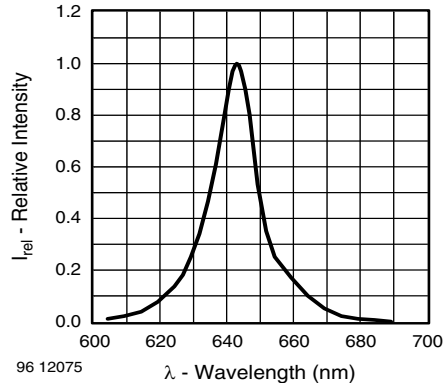

Fig. 4 - Relative Intensity vs. Wavelength

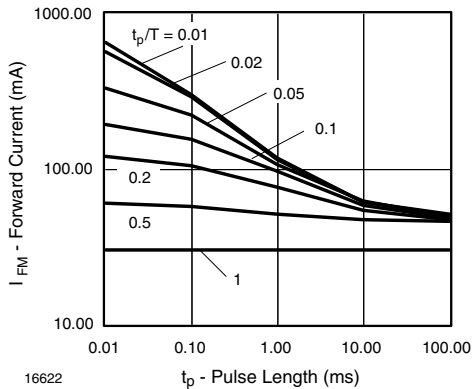

Fig. 2 - Forward Current vs. Pulse Length

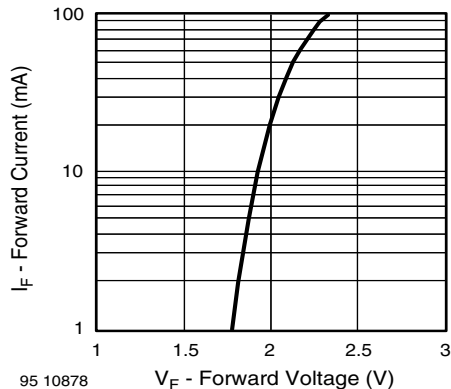

Fig. 5 - Forward Current vs. Forward Voltage

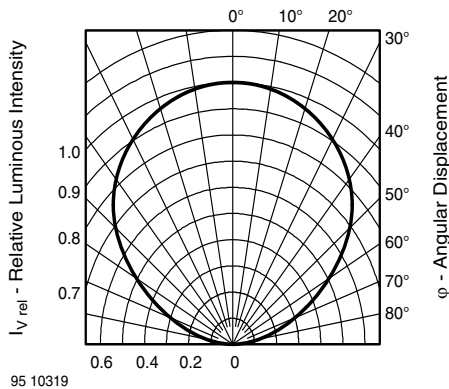

Fig. 3 - Relative Luminous Intensity vs. Angular Displacement

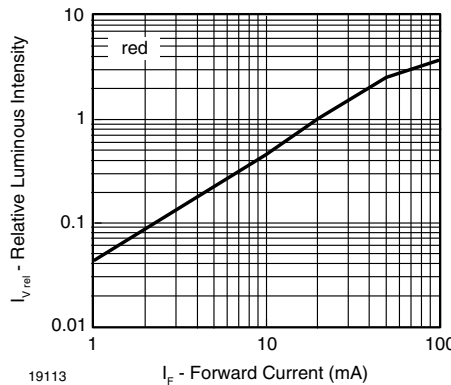

Fig. 6 - Relative Luminous Intensity vs. Forward Current

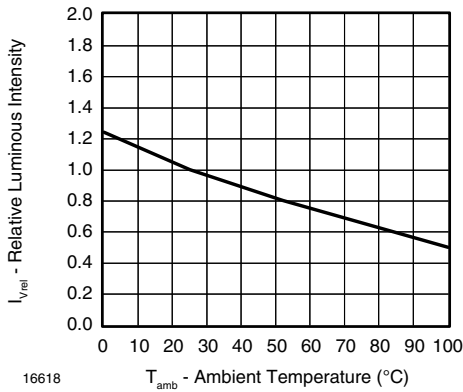

Fig. 7 - Relative Luminous Intensity vs. Ambient Temperature

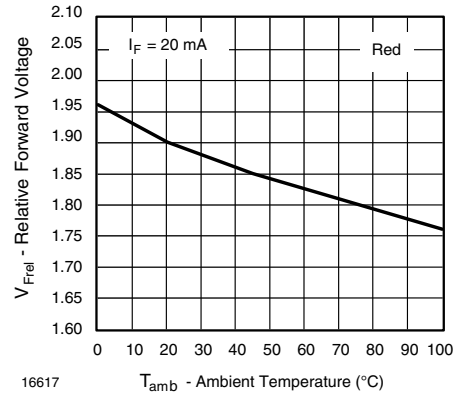
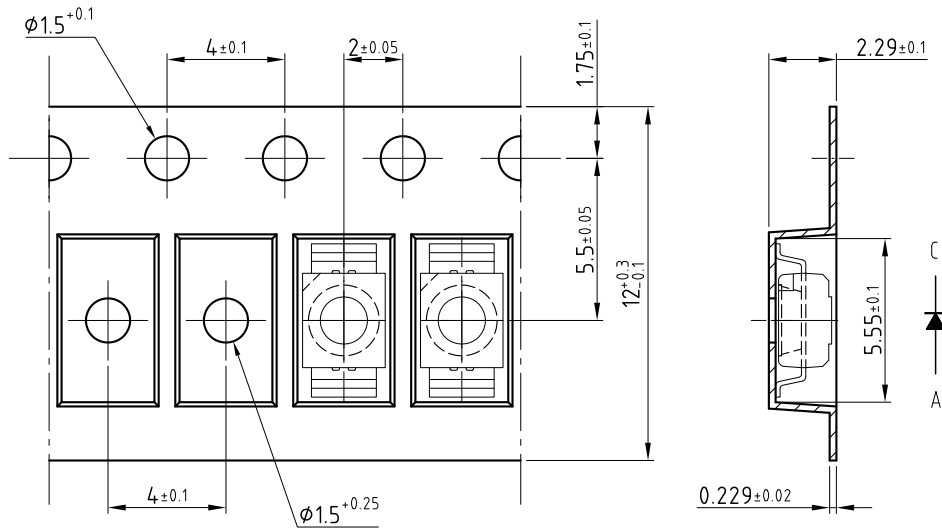

Fig. 8 - Forward Voltage vs. Ambient Temperature

**TAPING DIMENSIONS** in millimeters

Taping and orientation

Reels come in quantity of 8000 units or 2000 units.  
 Reel diameters are 330 mm and 180 mm respectively.



200 mm min. for $\phi$ 180 reel	480 mm min. for $\phi$ 180 reel
200 mm min. for $\phi$ 330 reel	9600 mm min. for $\phi$ 330 reel

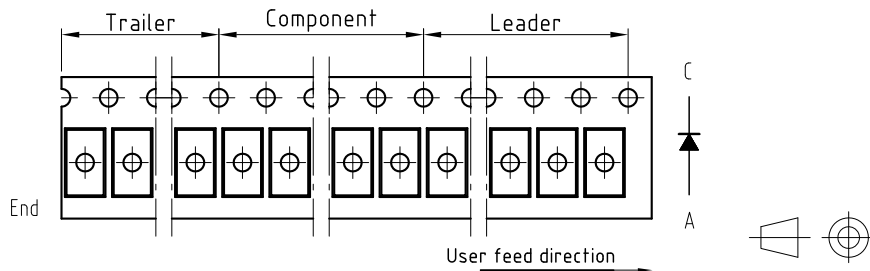

Drawing-No.: 9.700-5322.01-4  
 Issue: 1; 12.09.07  
 20858

Technical drawings according to DIN specifications

**PACKAGE DIMENSIONS** in millimeters

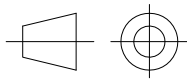
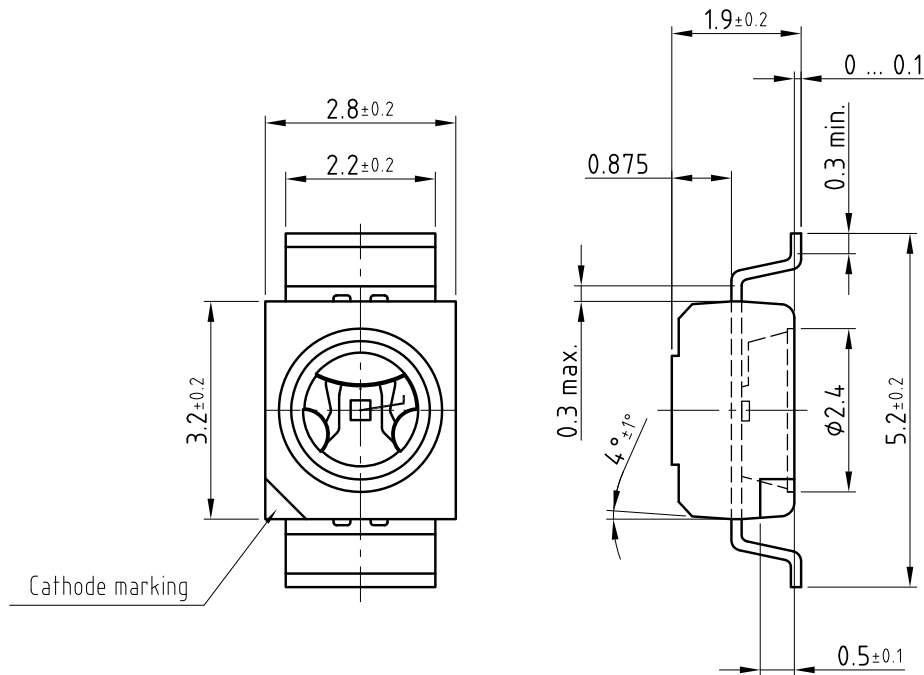

technical drawings according to DIN specifications

Drawing-No.: 6.541-5073.01-4  
 Issue: 1; 21.08.07  
 20859

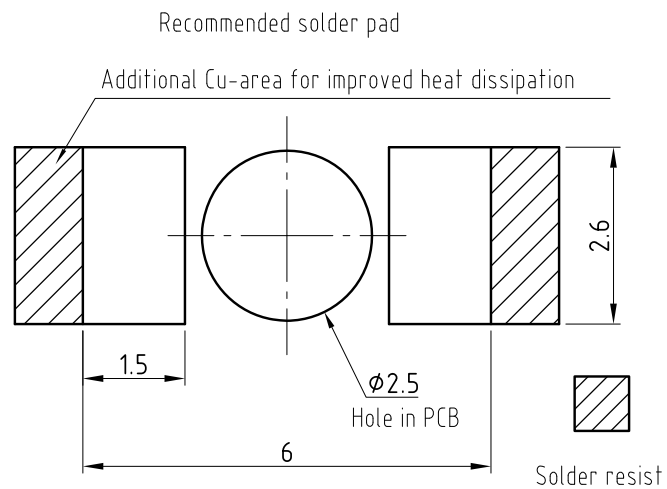

**REEL DIMENSIONS** in millimeters

Reel-dimension and shape:

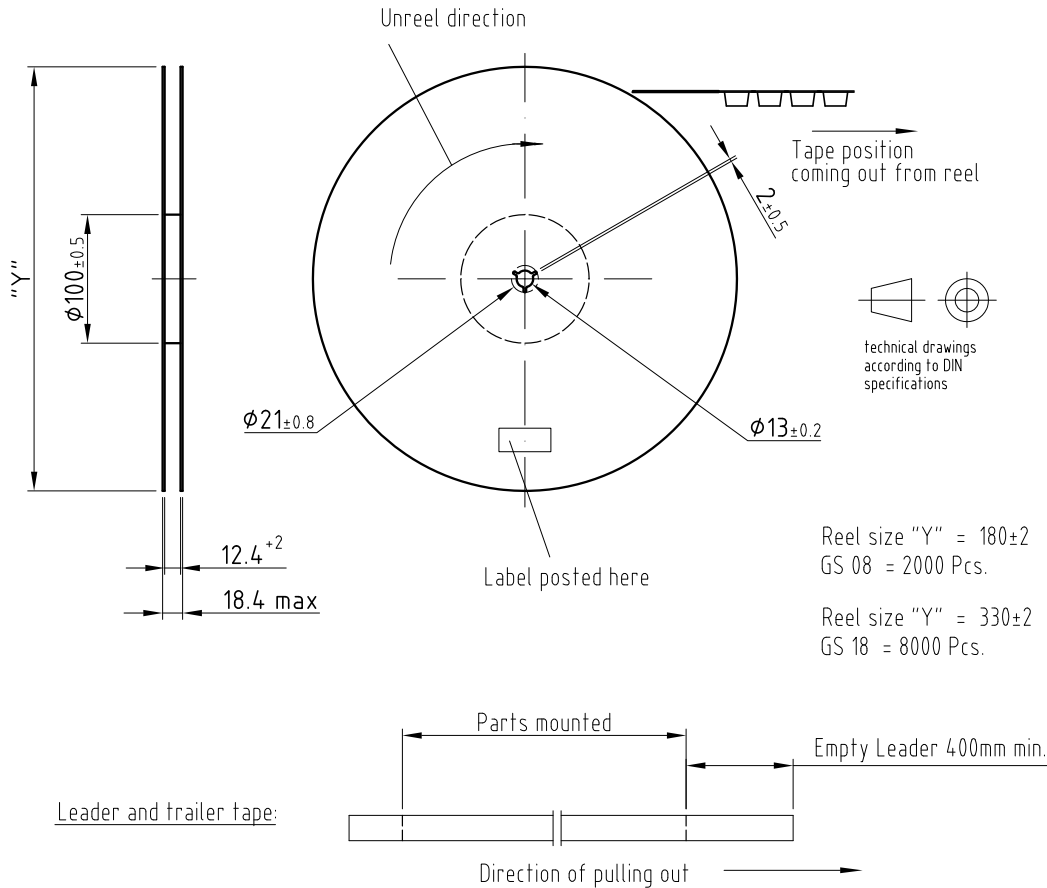

Drawing-No.: 9.800-5099.01-4

Issue: 2; 22.02.08

21067

**SOLDERING PROFILE**

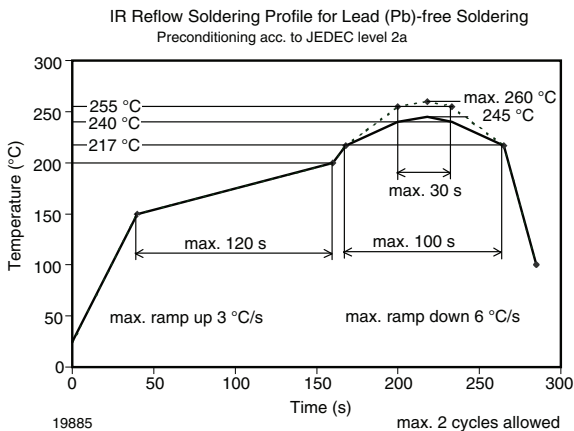

Fig. 9 - Vishay Lead (Pb)-free Reflow Soldering Profile (acc. to J-STD-020C)

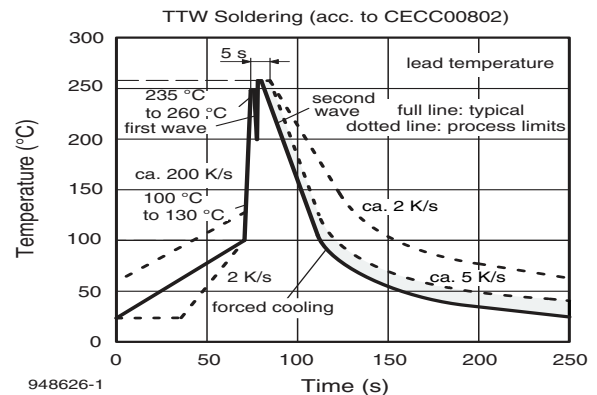
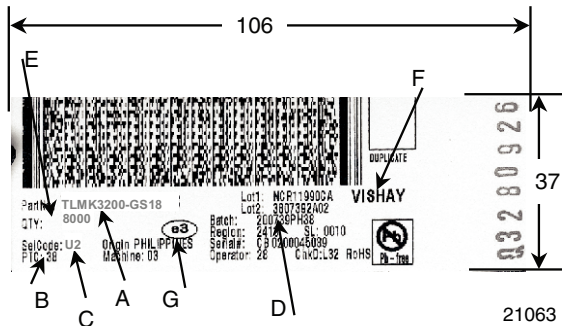

Fig. 10 - Double Wave Soldering of Opto Devices (all Packages)

**LABEL OF FAN FOLD BOX (example)**



- A. Type of component
- B. PTC = manufacturing plant
- C. SEL - selection code (bin):  
e.g.: U2 = code for luminous intensity group
- D. Batch/date code
- E. Company code
- F. Code for lead (Pb)-free classification (e3)

**DRY PACKING**

The reel is packed in an anti-humidity bag to protect the devices from absorbing moisture during transportation and storage.

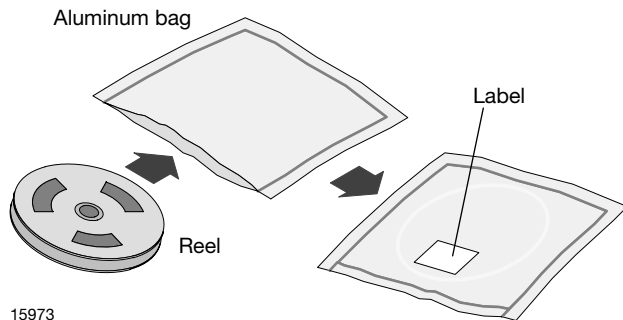

15973

**FINAL PACKING**

The sealed reel is packed into a cardboard box. A secondary cardboard box is used for shipping purposes.

**RECOMMENDED METHOD OF STORAGE**

Dry box storage is recommended as soon as the aluminum bag has been opened to prevent moisture absorption. The following conditions should be observed, if dry boxes are not available:

- Storage temperature 10 °C to 30 °C
- Storage humidity ≤ 60 % RH max.

After more than 672 h under these conditions moisture content will be too high for reflow soldering.

In case of moisture absorption, the devices will recover to the former condition by drying under the following condition: 192 h at 40 °C + 5 °C/- 0 °C and < 5 % RH (dry air/nitrogen) or

96 h at 60 °C + 5 °C and < 5 % RH for all device containers or  
24 h at 100 °C + 5 °C not suitable for reel or tubes.

An EIA JEDEC standard JESD22-A112 level 2a label is included on all dry bags.

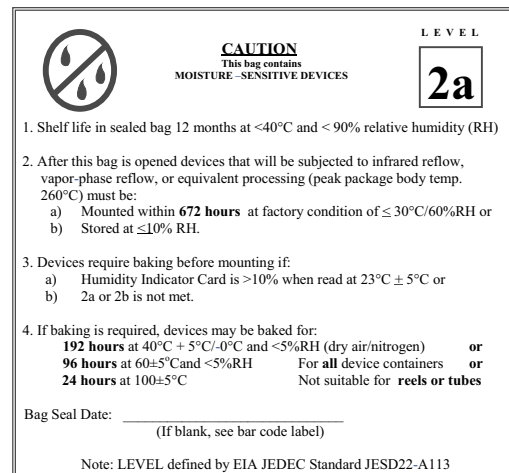

Example of JESD22-A112 level 2a label

**ESD PRECAUTION**

Proper storage and handling procedures should be followed to prevent ESD damage to the devices especially when they are removed from the antistatic shielding bag. Electro-static sensitive devices warning labels are on the packaging.

**VISHAY SEMICONDUCTORS STANDARD BAR CODE LABELS**

The Vishay Semiconductors standard bar code labels are printed at final packing areas. The labels are on each packing unit and contain Vishay Semiconductors specific data.



## **Disclaimer**

ALL PRODUCT, PRODUCT SPECIFICATIONS AND DATA ARE SUBJECT TO CHANGE WITHOUT NOTICE TO IMPROVE RELIABILITY, FUNCTION OR DESIGN OR OTHERWISE.

Vishay Intertechnology, Inc., its affiliates, agents, and employees, and all persons acting on its or their behalf (collectively, "Vishay"), disclaim any and all liability for any errors, inaccuracies or incompleteness contained in any datasheet or in any other disclosure relating to any product.

Vishay makes no warranty, representation or guarantee regarding the suitability of the products for any particular purpose or the continuing production of any product. To the maximum extent permitted by applicable law, Vishay disclaims (i) any and all liability arising out of the application or use of any product, (ii) any and all liability, including without limitation special, consequential or incidental damages, and (iii) any and all implied warranties, including warranties of fitness for particular purpose, non-infringement and merchantability.

Statements regarding the suitability of products for certain types of applications are based on Vishay's knowledge of typical requirements that are often placed on Vishay products in generic applications. Such statements are not binding statements about the suitability of products for a particular application. It is the customer's responsibility to validate that a particular product with the properties described in the product specification is suitable for use in a particular application. Parameters provided in datasheets and / or specifications may vary in different applications and performance may vary over time. All operating parameters, including typical parameters, must be validated for each customer application by the customer's technical experts. Product specifications do not expand or otherwise modify Vishay's terms and conditions of purchase, including but not limited to the warranty expressed therein.

Except as expressly indicated in writing, Vishay products are not designed for use in medical, life-saving, or life-sustaining applications or for any other application in which the failure of the Vishay product could result in personal injury or death. Customers using or selling Vishay products not expressly indicated for use in such applications do so at their own risk. Please contact authorized Vishay personnel to obtain written terms and conditions regarding products designed for such applications.

No license, express or implied, by estoppel or otherwise, to any intellectual property rights is granted by this document or by any conduct of Vishay. Product names and markings noted herein may be trademarks of their respective owners.