

**FLUKE®**

# 1730

Energy Logger

## Users Manual

September 2013

© 2013 Fluke Corporation. All rights reserved. Specifications are subject to change without notice.

All product names are trademarks of their respective companies.

## LIMITED WARRANTY AND LIMITATION OF LIABILITY

Each Fluke product is warranted to be free from defects in material and workmanship under normal use and service. The warranty period is two years and begins on the date of shipment. Parts, product repairs, and services are warranted for 90 days. This warranty extends only to the original buyer or end-user customer of a Fluke authorized reseller, and does not apply to fuses, disposable batteries, or to any product which, in Fluke's opinion, has been misused, altered, neglected, contaminated, or damaged by accident or abnormal conditions of operation or handling. Fluke warrants that software will operate substantially in accordance with its functional specifications for 90 days and that it has been properly recorded on non-defective media. Fluke does not warrant that software will be error free or operate without interruption.

Fluke authorized resellers shall extend this warranty on new and unused products to end-user customers only but have no authority to extend a greater or different warranty on behalf of Fluke. Warranty support is available only if product is purchased through a Fluke authorized sales outlet or Buyer has paid the applicable international price. Fluke reserves the right to invoice Buyer for importation costs of repair/replacement parts when product purchased in one country is submitted for repair in another country.

Fluke's warranty obligation is limited, at Fluke's option, to refund of the purchase price, free of charge repair, or replacement of a defective product which is returned to a Fluke authorized service center within the warranty period.

To obtain warranty service, contact your nearest Fluke authorized service center to obtain return authorization information, then send the product to that service center, with a description of the difficulty, postage and insurance prepaid (FOB Destination). Fluke assumes no risk for damage in transit. Following warranty repair, the product will be returned to Buyer, transportation prepaid (FOB Destination). If Fluke determines that failure was caused by neglect, misuse, contamination, alteration, accident, or abnormal condition of operation or handling, including overvoltage failures caused by use outside the product's specified rating, or normal wear and tear of mechanical components, Fluke will provide an estimate of repair costs and obtain authorization before commencing the work. Following repair, the product will be returned to the Buyer transportation prepaid and the Buyer will be billed for the repair and return transportation charges (FOB Shipping Point).

THIS WARRANTY IS BUYER'S SOLE AND EXCLUSIVE REMEDY AND IS IN LIEU OF ALL OTHER WARRANTIES, EXPRESS OR IMPLIED, INCLUDING BUT NOT LIMITED TO ANY IMPLIED WARRANTY OF MERCHANTABILITY OR FITNESS FOR A PARTICULAR PURPOSE. FLUKE SHALL NOT BE LIABLE FOR ANY SPECIAL, INDIRECT, INCIDENTAL OR CONSEQUENTIAL DAMAGES OR LOSSES, INCLUDING LOSS OF DATA, ARISING FROM ANY CAUSE OR THEORY.

Since some countries or states do not allow limitation of the term of an implied warranty, or exclusion or limitation of incidental or consequential damages, the limitations and exclusions of this warranty may not apply to every buyer. If any provision of this Warranty is held invalid or unenforceable by a court or other decision-maker of competent jurisdiction, such holding will not affect the validity or enforceability of any other provision.

Fluke Corporation  
P.O. Box 9090  
Everett, WA 98206-9090  
U.S.A.

Fluke Europe B.V.  
P.O. Box 1186  
5602 BD Eindhoven  
The Netherlands

11/99

To register your product online, visit [register.fluke.com](http://register.fluke.com).

# Table of Contents

Title	Page
Introduction .....	1
How to Contact Fluke .....	2
Safety Information.....	2
Before You Start .....	5
Tilt Stand.....	6
Hanger Accessory.....	6
Storage .....	7
Power Supply .....	7
How to Charge Battery .....	8
Accessories .....	9
Thin-Flexi Current Probe.....	10
Test Leads .....	11
Kensington Lock .....	11
Navigation and User Interface .....	12
Applying the Connector Panel Decal .....	14
Power ON/OFF .....	15
Mains Power Source .....	15
Measurement Line Power Source .....	15
Power from Battery .....	16

Touch Screen.....	17
Brightness Button.....	17
Calibration.....	17
Basic Navigation.....	17
Function Selection Buttons.....	18
Meter.....	18
Power.....	25
Logger.....	25
Memory/Settings Button.....	29
Logging Sessions.....	29
Screen Capture.....	30
Instrument Settings.....	30
Touch Screen Calibration.....	32
Firmware Update.....	33
Firmware Version.....	33
Reset to Factory Defaults.....	34
First-time Use/Setup Wizard.....	34
First Measurements.....	35
Maintenance.....	37
How to Clean.....	37
Battery Replacement.....	37
Calibration.....	37
Service and Parts.....	38
Energy Analyze Software.....	40
System Requirements.....	40
PC Connections.....	41
Wiring Configurations.....	42
Specifications.....	45

## ***List of Tables***

<b>Table</b>	<b>Title</b>	<b>Page</b>
1.	Symbols .....	4
2.	Accessories .....	9
3.	Front Panel .....	12
4.	Connector Panel .....	13
5.	Power/Battery Status .....	16
6.	Replacement Parts .....	38



## ***List of Figures***

<b>Figure</b>	<b>Title</b>	<b>Page</b>
1.	Country-Specific Mains Cords .....	5
2.	Hanger Accessory .....	6
3.	Power Supply and Battery .....	7
4.	R-Coil Operation Principle .....	10
5.	Test Leads with Color Coding .....	11
6.	Front Panel .....	12
7.	Connector Panel .....	13
8.	Decal for Connector Panel.....	14
9.	Replacement Parts .....	39
10.	Energy Logger to PC Connections .....	41
11.	iFlex Probe Window.....	51
12.	i40s-EL Setup .....	53





## **Introduction**

The 1730 Energy Logger (the Logger or Product) is a compact device for energy surveys. With a built-in touch screen and USB flash drive support, it is very easy to configure, verify, and download measurement sessions without the need of a computer at the measurement location.

The Logger makes these measurements:

- **Basic Measurements:** Voltage (V), Current (A), Frequency (Hz), Phase rotation indication, 2 dc Channels (supports user-supplied external sensor for other measurements such as temperature, humidity, and air speed)
- **Power:** Active Power (W), Apparent Power (VA), Non-active Power, (var), Power Factor
- **Fundamental Power:** Fundamental Active Power (W), Fundamental Apparent Power (VA), Fundamental Reactive Power (var), DPF (Cos $\Phi$ )

- **Energy:** Active Energy (Wh), Apparent Energy (VAh), Non-active Energy (varh)
- **Demand:** Demand (Wh), Maximum Demand (Wh), Energy costs
- **Harmonic Distortion:** Total Harmonic Distortion of Voltage and Current

Fluke Energy Analyze software is included with the Product for a thorough energy analysis and professional report of the measurement results.

## How to Contact Fluke

To contact Fluke, use one of these telephone numbers:

- USA: 1-800-760-4523
- Canada: 1-800-36-FLUKE (1-800-363-5853)
- Europe: +31 402-675-200
- Japan: +81-3-6714-3114
- Singapore: +65-6799-5566
- Anywhere in the world: +1-425-446-5500

Or, visit Fluke's website at [www.fluke.com](http://www.fluke.com).

To register your Product, visit <http://register.fluke.com>.

To view, print, or download the latest manual supplement, visit <http://us.fluke.com/usen/support/manuals>.

Go to [www.flukenation.com](http://www.flukenation.com) for more information about real-world applications and software downloads.

## Safety Information

A **Warning** identifies hazardous conditions and procedures that are dangerous to the user. A **Caution** identifies conditions and procedures that can cause damage to the Product or the equipment under test.

### Warning









To prevent possible electrical shock, fire, or personal injury:



- **Read all safety information before you use the Product.**
- **Use the Product only as specified, or the protection supplied by the Product can be compromised.**
- **Comply with local and national safety codes. Use personal protective equipment (approved rubber gloves, face protection, and flame-resistant clothes) to prevent shock and arc blast injury where hazardous live conductors are exposed.**
- **Examine the case before you use the Product. Look for cracks or missing plastic. Carefully look at the insulation around the terminals.**
- **Replace the mains power cord if the insulation is damaged or if the insulation shows signs of wear.**

- Use Product-approved measurement category (CAT), voltage, and amperage rated accessories (probes, test leads, and adapters) for all measurements.
- Do not use test leads if they are damaged. Examine the test leads for damaged insulation and measure a known voltage.
- Do not use the Product if it is damaged.
- The battery door must be closed and locked before you operate the Product.
- Do not work alone.
- Use this Product indoors only.
- Do not use the Product around explosive gas, vapor, or in damp or wet environments.
- Use only the external mains power supply included with the Product.
- Do not exceed the Measurement Category (CAT) rating of the lowest rated individual component of a Product, probe, or accessory.
- Keep fingers behind the finger guards on the probes.
- Do not use a current measurement as an indication that a circuit is safe to touch. A voltage measurement is necessary to know if a circuit is hazardous.
- Do not touch voltages >30 V ac rms, 42 V ac peak, or 60 V dc.
- Do not apply more than the rated voltage, between the terminals or between each terminal and earth ground.
- Measure a known voltage first to make sure that the Product operates correctly.
- De-energize the circuit or wear personal protective equipment in compliance with local requirements before you apply or remove the flexible current probe.
- Remove all probes, test leads, and accessories before the battery door is opened.

Table 1 is a list of symbols used on the Product or in this manual.

**Table 1. Symbols**

Symbol	Description
	Risk of Danger. Important information. See manual.
	Hazardous voltage
	Conforms to relevant South Korean EMC standards
	Battery
	Conforms to relevant Australian EMC standards
	Conforms to relevant North American Safety Standards
	Conforms to European Union directives
	Double Insulation
CAT II	Measurement Category II is applicable to test and measuring circuits connected directly to utilization points (socket outlets and similar points) of the low-voltage MAINS installation.

CAT III	Measurement Category III is applicable to test and measuring circuits connected to the distribution part of the building's low-voltage MAINS installation.
CAT IV	Measurement Category IV is applicable to test and measuring circuits connected at the source of the building's low-voltage MAINS installation.
 Li-ion	This product contains a Lithium-ion battery. Do not mix with the solid waste stream. Spent batteries should be disposed of by a qualified recycler or hazardous materials handler per local regulations. Contact your authorized Fluke Service Center for recycling information.
	This product complies with the WEEE Directive (2002/96/EC) marking requirements. The affixed label indicates that you must not discard this electrical/electronic product in domestic household waste. Product Category: With reference to the equipment types in the WEEE Directive Annex I, this product is classed as category 9 "Monitoring and Control Instrumentation" product. Do not dispose of this product as unsorted municipal waste. Go to Fluke's website for recycling information.

## **Before You Start**

Below is a list of the items included with your purchase. Carefully unpack and inspect each of the items:

- 1730 Energy Logger
- Power Supply
- Voltage Test Lead
- Dolphin Clip, Black
- i1730-flex1500 Thin-Flexi Current Probe, 30.5 cm (12 in) quantity 3
- Color-coded Wire Clips
- Power Cord (see Figure 1)
- Test lead with stackable plugs, 10 cm (3.9 in)
- Test lead with stackable plugs, 2 m (6.6 ft)
- DC Power Cable
- USB Cable A, Mini-USB
- Soft Storage Bag/Case
- Input Connector Decal

The power cord and input connector decal are country-specific and vary according to the order destination. See Figure 1.

- Documentation Info Pack (Quick Reference Card, Safety Information, Battery Pack Safety Information, iFlex Probe Safety Information, i40s-EL Current Clamp Safety Information)
- 4 GB USB Flash Drive (includes Users Manual and PC application software, Fluke Energy Analyze)

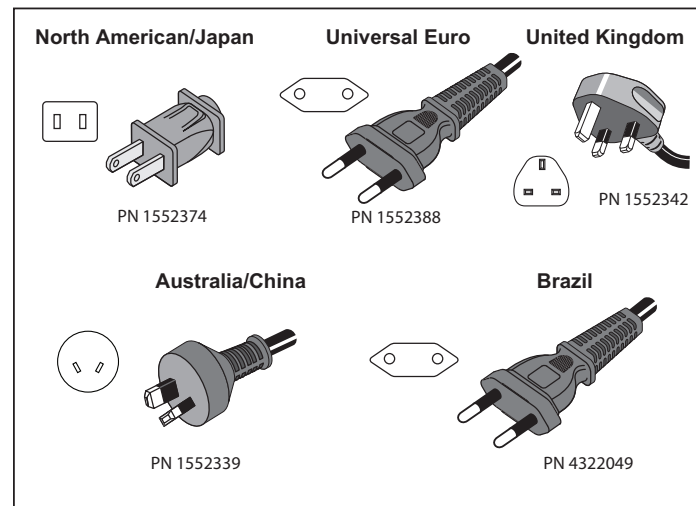

hcf059.eps

**Figure 1. Country-Specific Mains Cords**

### Tilt Stand

The power supply includes a tilt stand. When used, the tilt stand positions the display at a good angle for use on a tabletop surface. To use, attach the power supply to the Logger and open the tilt stand.

### Hanger Accessory

The optional hanger accessory shown in Figure 2 is used to:

- Hang the Logger with power supply attached (use two magnets)
- Hang the Logger separately (use two magnets)
- Hang the power supply separately (use one magnet)

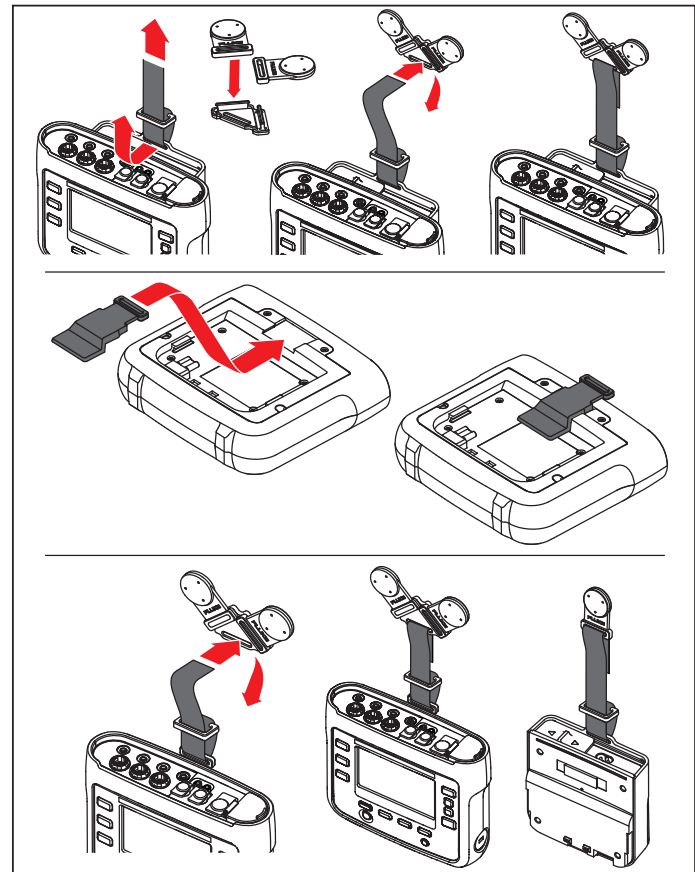

hcf058.eps

Figure 2. Hanger Accessory

## Storage

When not in use, keep the Logger in the protective storage bag/case. The bag/case has sufficient space for the Logger and all the accessories.

If the Logger is stored for an extended period of time or is not in use for a long time, you should charge the battery at least once every six months.

## Power Supply

The Logger includes a removable power supply, see Figure 3. The power supply is either attached to the Logger or used externally with a DC power cord. The configuration with the externally connected power supply is preferred in locations where the Logger with the power supply attached is too big to fit in a cabinet between the door and panel.

When the power supply is connected with the Logger and connected to line power, it:

- converts line power to dc power and is used directly by the Logger
- automatically turns on the Logger and continuously powers the Logger from the external source (after initial power on, the power button turns on and turns off the Logger)
- recharges the battery

The power cord/measurement line cover slides to select the input source.

### ⚠⚠ Warning

**To prevent possible electrical shock, fire, or personal injury, do not use the power supply if the power cord/measurement line slide-cover is missing.**

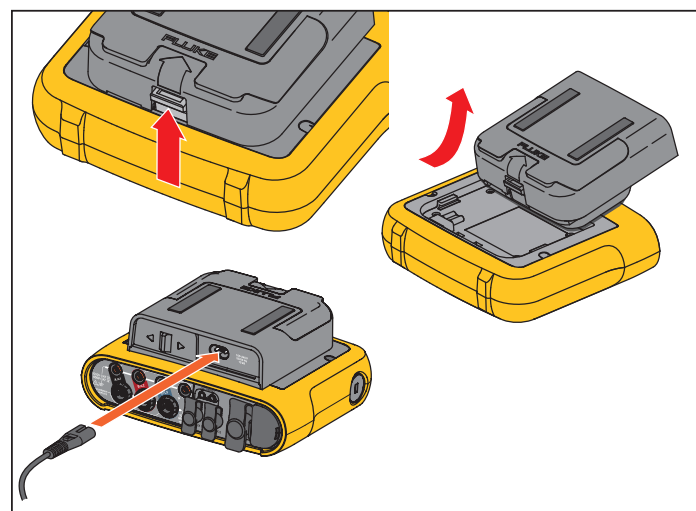

hcf031.eps

Figure 3. Power Supply and Battery

## How to Charge Battery

The Logger also operates on an internal rechargeable Lithium-ion battery. After you unpack and inspect the Logger, fully charge the battery before first use. Afterwards, charge the battery when the battery icon on the screen indicates that power is low. The battery automatically charges when the Logger is connected to the mains power. The Logger continues to charge when turned off and connected to mains power.

### Note

*The battery charge is faster when the Logger is turned off.*

To charge the battery:

1. Connect the mains cord to the ac input socket on the power supply.
2. Fit the power supply to the Logger or use the dc power cord to connect the power supply to the Logger.
3. Connect to mains power.

### Caution

To prevent damage to the Product:

- **Do not leave batteries unused for extended periods of time, either in the product or in storage.**
- **When a battery has not been used for six months, check the charge status and charge the battery as appropriate.**
- **Clean battery packs and contacts with a clean, dry cloth.**
- **Battery packs must be charged before use.**
- **After extended storage, it can be necessary to charge and discharge a battery pack to obtain maximum performance.**
- **Dispose properly.**

### Note

- *Li-ion batteries keep a charge longer if stored at room temperature.*
- *The clock resets when the battery is completely discharged.*
- *When the Logger shuts off because of low battery, enough battery capacity is available to back up the real-time clock for up to 2 months.*



## Accessories

Table 2 is a list of the accessories that are available and sold separately for the Logger. The warranty on included accessories is 1 year.

**Table 2. Accessories**

Description	Part Number
i1730-flex 1500 Thin-Flexi Current Probe (single)	4345324
i1730-flex1500/3PK Set of three Thin-Flexi Current Probes 1500 A 30.5 cm (12 in)	4357406
i1730-flex 3000 Thin-Flexi Current Probe (single)	4345616
i1730-flex3000/3PK Set of three Thin-Flexi Current Probes 3000 A 61 cm (24 in)	4357414
i1730-flex 6000 Thin-Flexi Current Probe (single)	4345625
i1730-flex6000/3PK Set of three Thin-Flexi Current Probes 6000 A 90.5 cm (36 in)	4357423
Fluke-1730 Test Lead, 0.10 m	4344653
Fluke-1730 Test Lead, 2 m	4344675

3PHVL-1730, Voltage Test Lead 3-phase + N,	4344712
i40s-EL Current Clamp, 40 A	4345270
i40s-EL/3PK, Set of three Current Clamps, 40 A	4357438
Fluke-1730-Hanger Kit	4358028
Lithium-ion Battery	4389436
Auxiliary Input Cable	4395217
C1730, Soft Case	4345187

### Thin-Flexi Current Probe

The Thin-Flexi Current Probe works on the Rogowski coil (R-coil) principle that is a toroid of wire used to measure an alternating current through a cable encircled by the toroid. See Figure 4.

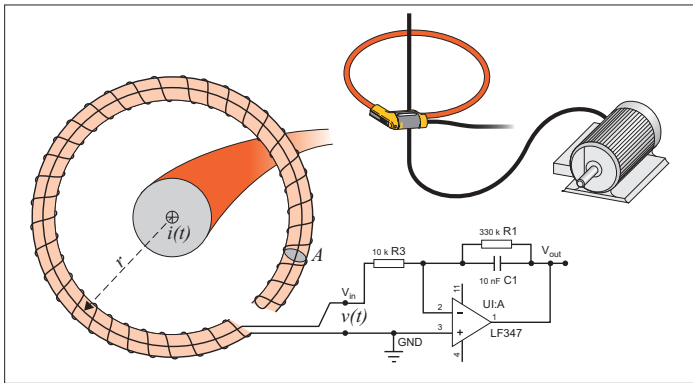

hcf028.eps

Figure 4. R-Coil Operation Principle

The R-coil has many advantages over other types of current transformers:

- It is not a closed loop. The second terminal is passed back through the center of the toroid core (commonly a plastic or rubber tube) and connected along the first terminal. This allows the coil to be open-ended, flexible, and able to be wrapped around a live conductor without disturbing it.
- It has an air core rather than an iron core. It has a low inductance and can respond to fast-changing currents.
- Because it has no iron core to saturate, it is highly linear even when subjected to large currents, such as those used in electric power transmission or pulsed-power applications.

A correctly formed R-coil, with equally spaced windings, is largely immune to electromagnetic interference.

### **Test Leads**

Test leads are four-core, flat, test leads that do not tangle and can be installed in tight spaces. On installations where the access to Neutral is out of reach with the three-phase test lead, use the black test lead to extend the Neutral lead.

For single phase measurements use the red and black test leads. See Figure 5.

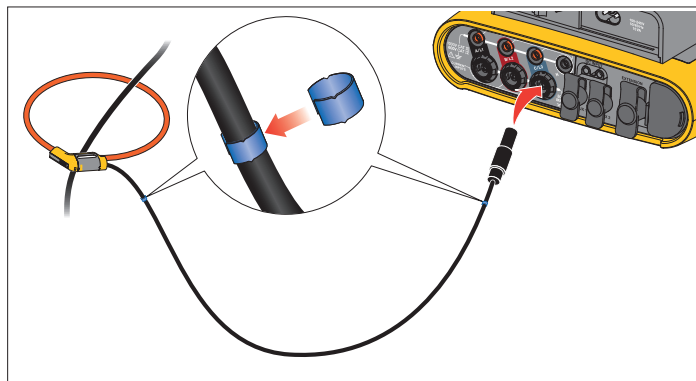

hcf025.eps

**Figure 5. Test Leads with Color Coding**

### **Kensington Lock**

A Kensington Security Slot (also called a K-Slot or Kensington lock) is part of a built-in anti-theft system. It is a small, metal-reinforced, oval hole found on the right side of the Logger (see item 6 in Table 3). It is used for attaching a lock-and-cable apparatus. The lock is secured in place with a key or combination lock attached to a plastic-cover metal cable. The end of the cable has a small loop that allows the cable to be looped around a permanent object, such as a cabinet door, to secure it in place. This lock is available from most electronics and computer suppliers.

## Navigation and User Interface

See Figure 8 and Table 3 for a list of the front panel controls and their functions. See Figure 7 and Table 4 is a list of the connectors and their functions.

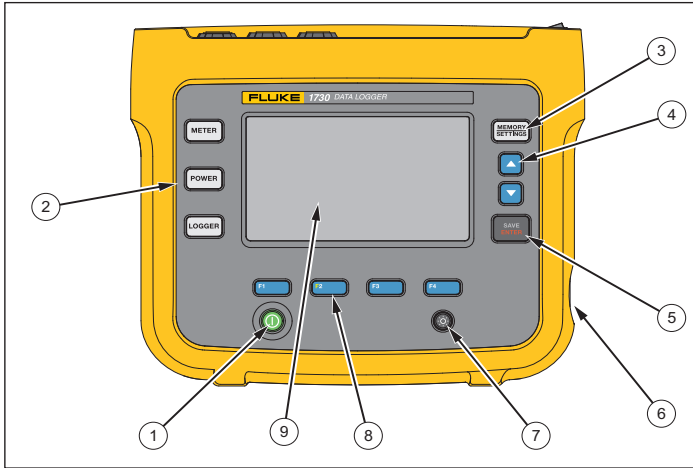

hcf023.eps

Figure 6. Front Panel

Table 3. Front Panel

Item	Control	Description
①	①	Power on/off and status
②	METER POWER LOGGER	Meter, Power, or Logger function selection
③	MEMORY SETTINGS	Memory/Setup selection
④	▲ ▼	Cursor control
⑤	SAVE ENTER	Selection control
⑥	Kensington lock	
⑦	☀	Backlight on/off
⑧	F1 F2 F3 F4	Softkey selection
⑨	Touch screen display	

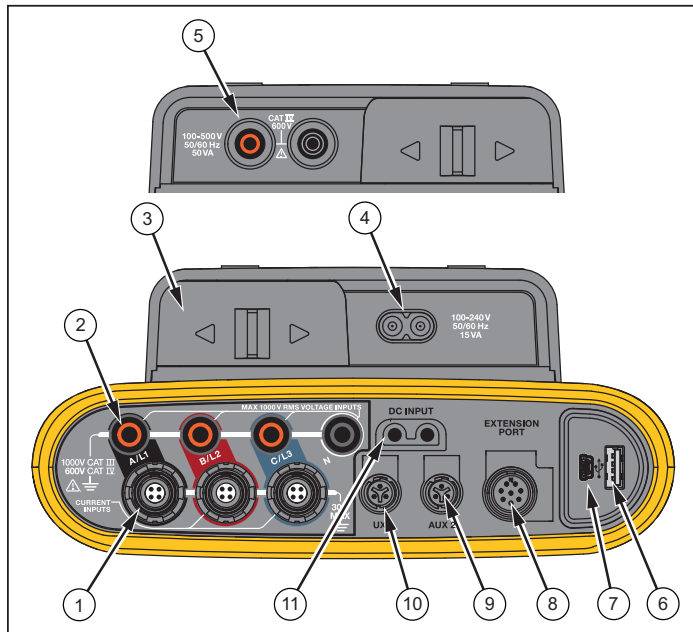

**Figure 7. Connector Panel**

hcf021.eps

**Table 4. Connector Panel**

Item	Description
①	Current measurement inputs (3 phases)
②	Voltage measurement inputs (3 phases)
③	Power Cord/Measurement Line Slide-Cover
④	Power Cord AC Input 100-240 V 50/60 Hz 15 VA
⑤	Measurement line AC Input 100-500 V 50/60 Hz 50 VA
⑥	USB connector
⑦	Mini-USB connector
⑧	Extension Port
⑨	Aux 2 connector
⑩	Aux 1 connector
⑪	DC Power Input

### Applying the Connector Panel Decal

Self-adhesive decals are supplied with the Logger. The decals correspond to the wiring color codes used in the USA, Europe and UK, UK (old), Canada, and China. Apply the decal appropriate for your local wiring codes around the current and voltage inputs on the connector panel as shown in Figure 8.

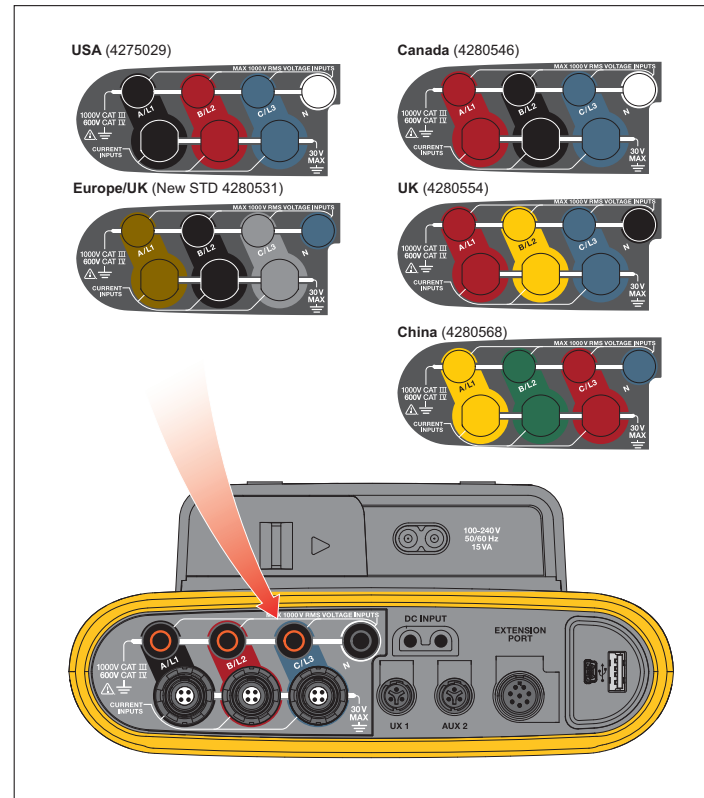

hcf022.eps

Figure 8. Decal for Connector Panel

## **Power ON/OFF**

The Logger has several options for power: mains, measurement line, and battery. The front panel LED shows the status. See Table 5 for more information.

### **Mains Power Source**

1. Attach the power supply to the Logger or use the dc power cord to connect the power supply to the Logger.
2. Move the slide-cover on the power supply to access the mains socket and connect the power cord into the Logger.

The Logger automatically turns on and is ready to use in <20 seconds.

3. Push  to turn on and turn off the Logger.

### **Measurement Line Power Source**

1. Attach the Power Supply to the Logger or use the dc power cord to connect the Power Supply with the Logger.
2. Move the slide-cover on the power supply to access the safety sockets and connect these sockets with the voltage input sockets A/L1 and N.

For 3-phase delta systems connect the safety sockets of the power supply with the input sockets A/L1 and B/L2.

Use the short test leads for all applications where the measured voltage does not exceed the rated input voltage of the power supply.

3. Connect the voltage inputs to the test points.

The Logger automatically turns on and is ready to use in <20 seconds.

#### **Caution**

**To prevent damage to the product, make sure the measured voltage does not exceed the input rating of the power supply.**

#### **Warning**







**To prevent injury, do not touch the metal parts of one test lead when the other is still connected to hazardous voltage.**

### Power from Battery

The Logger can operate on battery power without a connection to the power supply or dc power cord. Push ①. The Logger turns on and is ready to use in <20 seconds.

The battery symbol in the status bar and the power LED indicate the battery status.

**Table 5. Power/Battery Status**

Logger On						Logger OFF		
Power Source	Battery Symbol	Power LED	Estimated Runtime for LCD Hours:Minutes			Power Source	Battery Status	Power LED color
			Off	Brightness low	Brightness high			
Mains		green	NA			Mains	off	OFF
Battery		yellow	5:30	4:50	3:45			
Battery		yellow						
Battery		yellow						
Battery		yellow						
Battery		red	0:18	0:16	0:12			
<b>Logger Status</b>								
not logging		steady						
logging		flashing						



## **Touch Screen**

The touch screen enables you to interact directly with what is on the display. To change parameters, touch a target on the display with a finger. Touch targets are easy to recognize, such as large buttons, items in menus, or keys of the virtual keyboard. The Product can be operated with insulating gloves on (resistive touch).

### **Brightness Button**

The touch screen has a backlight for work in dimly lit spaces. See Table 3 for the location of the Brightness (⚙️) button. Push ⚙️ to adjust the brightness in two levels and to turn on and turn off the display.



The brightness is set to 100 % when the Logger is powered from mains. When powered from battery, the default brightness is set to the power-save level of 30 %. Push ⚙️ to toggle between the two brightness levels.



Push and hold ⚙️ for 3 seconds to turn off the display.  
Push ⚙️ to turn on the display.





## **Calibration**

The touch screen is pre-calibrated in the factory. If you notice that the targets do not align with your touch on the display, you can calibrate the display. Calibration of the touch screen is available in the  menu. See page 32 for more information about the touch screen calibration.

## **Basic Navigation**

When an option menu shows on the display, you can use   to move within the menu.

The  button has a dual use. In the Configuration and Setup screens, push  to confirm the selection. In all other screens, push  for 2 seconds to take a screen shot. A beep confirms the action. See *Screen Capture* for more information about how to review, manage, and copy the screen shots.

Along the bottom of the display, a row of labels shows the available functions. Push    or  below the display label to start that function. These labels also work as touch targets.

## Function Selection Buttons



The Logger has three buttons that toggle between the Meter, Power, and Logger function modes. The current mode shows in the upper left corner of the display:

### Meter

 – The Meter mode is for measurement values of each phase (A/L1, B/L2, C/L3) as:

- Voltage (V)
- Current (A)
- Frequency (Hz)
- THD of Voltage and Current (%)
- AUX Voltage (V)

You can determine the values or display a trend chart of the last 7 minutes. In the chart:

1. Use  or the cursor keys to show the list of available parameters.
  2. Push  (Reset) to clear the graph and restart.
- It is also possible to log the values with the logger function.

### Measurement Configuration

Use the **Change Configuration** touch button to access the measurement configuration screen. The configuration screen allows you to change the parameters for:

- Study type
- Topology
- Nominal voltage (for load studies only)
- Current range
- Scale factors for external VTs or CTs

### Study Type

Depending on the application, select either Load Study or Energy Study.

- **Energy Study:** Select this study type when power and energy values including active power (W) and PF are required.
- **Load Study:** For convenience, some applications require you to measure only the current that makes the connection to the point to measure.

Typical applications are:

- Verify the circuit capacity before adding additional load.
- Identify situations where the allowable load can be exceeded.

Optionally, a nominal voltage can be configured to get pseudo-apparent power readings.

### Topology (Distribution System)

Select the appropriate system. A connection diagram for the voltage test leads and current sensors is shown on the Logger.

A diagram is also available with  (Connection diagram) from the **Change Configuration** menu. Examples of these diagrams are shown on the following pages.

**Single Phase**

Example: Branch circuit at an outlet.

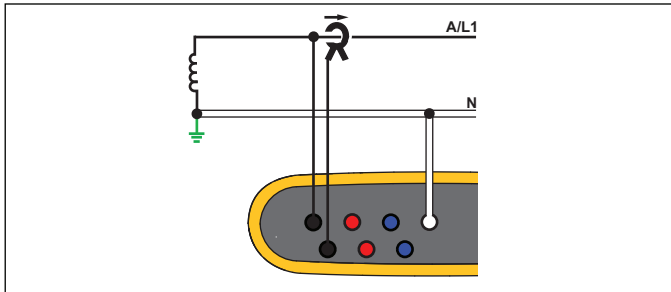

hcf040.eps

Energy Study

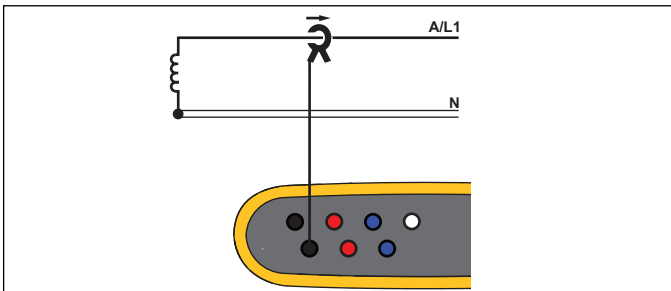

hcf041.eps

Load Study (no voltage measurement)

**Single Phase IT**

The logger has a galvanic isolation between the voltage inputs and ground based signals like USB and mains input.

Example: Used in Norway and in some hospitals. This would be the connection at a branch circuit.

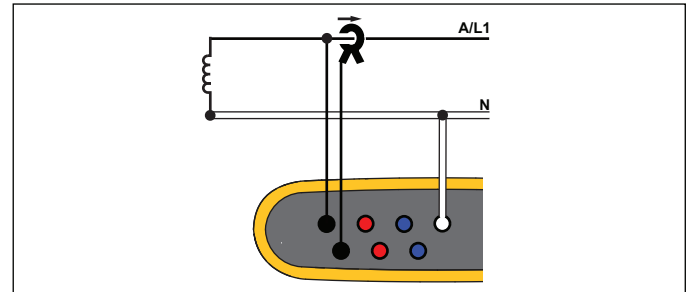

hcf042.eps

Energy Study

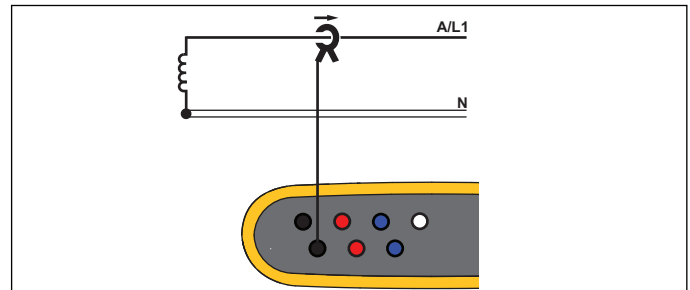

hcf041.eps

Load Study (no voltage measurement)

### Split Phase

Example: A North American residential installation at the service entrance.

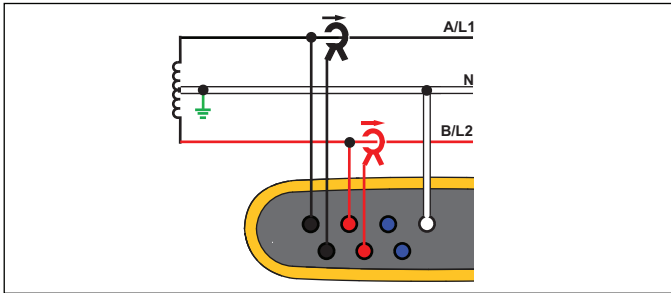

hcf043.eps

Energy Study

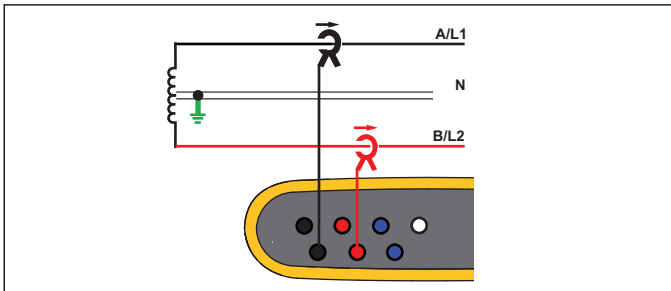

hcf044.eps

Load Study (no voltage measurement)

### 3- $\Phi$ Wye

Example: Also called "Star" or four-wire connection. Typical commercial building power.

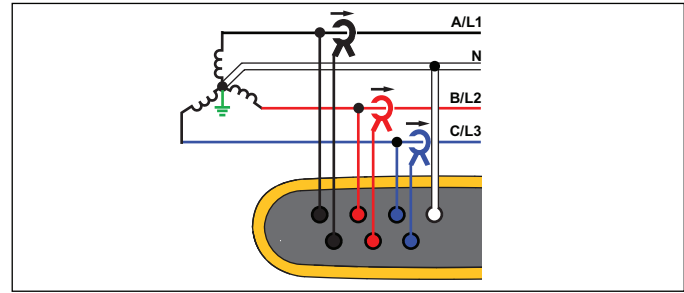

hcf045.eps

Energy Study

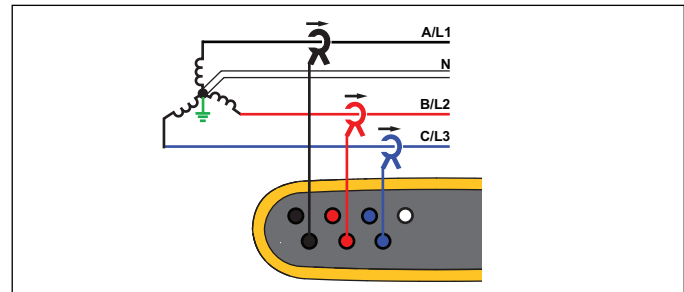

hcf046.eps

Load Study (no voltage measurement)

### 3- $\Phi$ Wye IT

The logger has a galvanic isolation between the voltage inputs and ground based signals like USB and mains input.

*Example: Industrial power in countries that use the IT (Isolated Terra) system, such as Norway.*

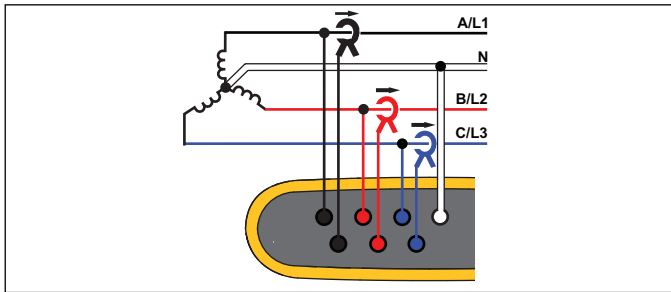

hcf047.eps

Energy Study

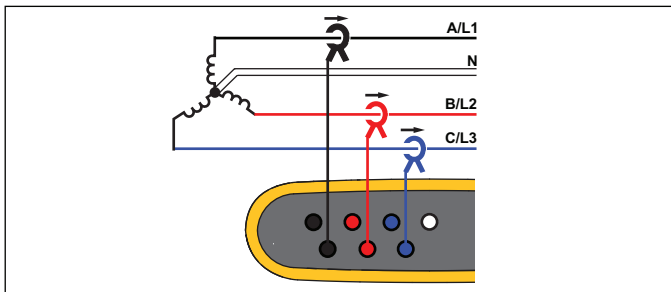

hcf048.eps

Load Study (no voltage measurement)

### 3- $\Phi$ Wye Balanced

*Example: For symmetrical loads like motors the connection can be simplified by measuring only one phase and assuming the same voltages/currents on the other phases.*

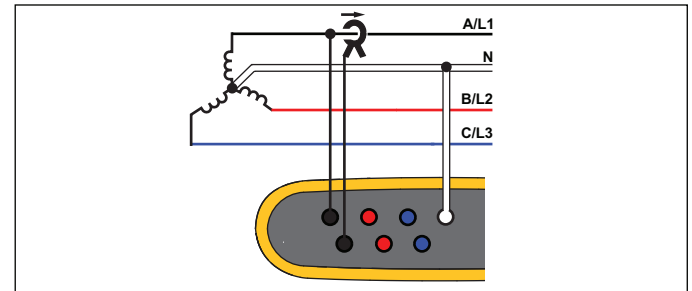

hcf049.eps

Energy Study

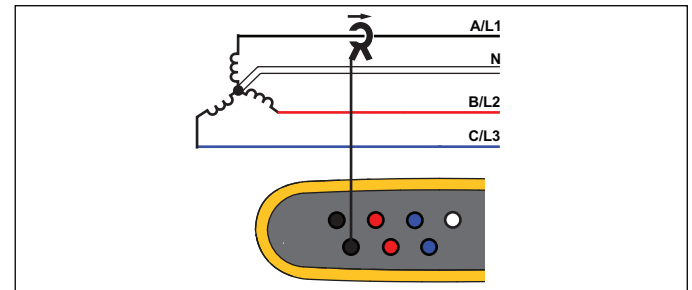

hcf050.eps

Load Study (no voltage measurement)

### 3- $\Phi$ Delta

Example: Often found in industrial settings where electric motors are used.

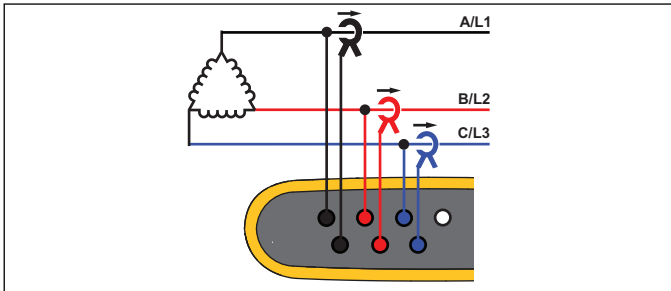

hcf051.eps

Energy Study

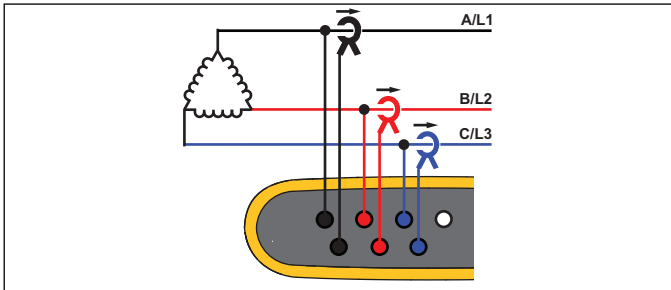

hcf052.eps

Load Study (no voltage measurement)

### 3- $\Phi$ Delta Open Leg

Example: A variant of power transformer winding type.

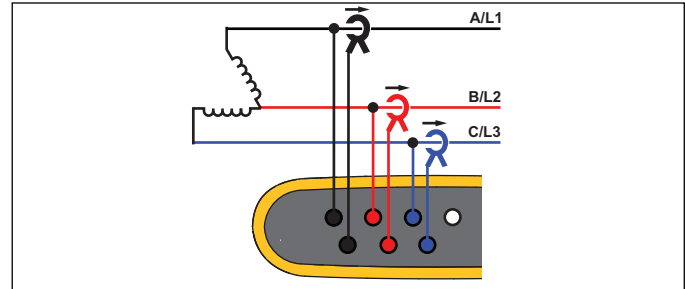

hcf053.eps

Energy Study

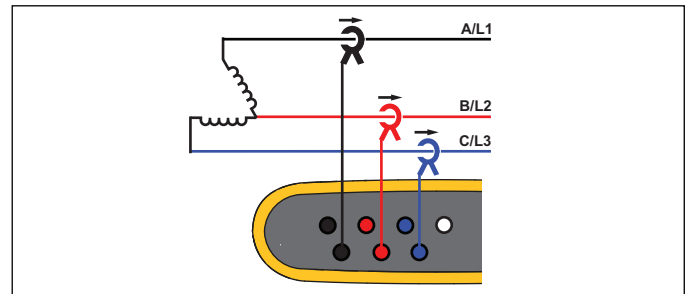

hcf054.eps

Load Study (no voltage measurement)

## 2 Element Delta (Aron/Blondel)

Example: Blondel or Aron connection, simplifies the connection by the use of only two current sensors.

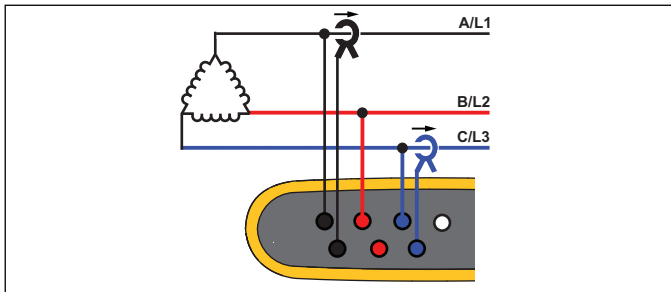

Energy Study

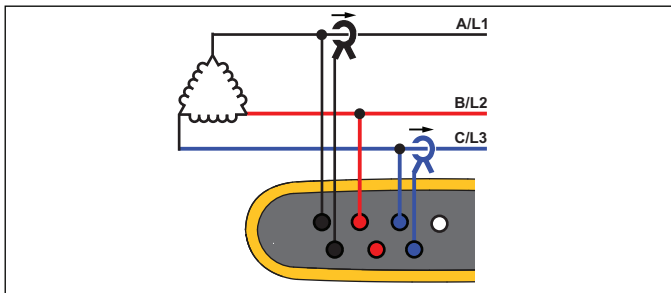

Load Study (no voltage measurement)

### Note

Make sure that the current arrow on the sensor is directed towards the load to provide positive power values. The current sensor direction can be corrected digitally in the Connection Verification screen.

## Nominal Voltage: Load Studies Only

Select a nominal voltage from the list. If a voltage is not shown in the list, a custom voltage can be entered. Set the nominal voltage to off if the apparent power readings are not required.

## Current Range

Configure the current range of the attached sensor. Three ranges are available:

- Auto
- Low Range
- High Range

When set to Auto, the current range is set automatically and depends on the measured current.

Low Range is 1/10 of the nominal range of the attached current sensor. For example, the low range of an iFlex1500-12 is 150 A.

High Range is the nominal range of the attached current sensor. For example 1500 A on an iFlex 1500-12.

### Note

Set the current range to Auto when you are not sure about the maximum current during the logging session. A specific application can require you to set the current range to a fixed range rather than Auto. This can occur because the Auto range is not gap-less and may lose too much information in the case of a highly fluctuating current.

### *Voltage Ratio (only in energy studies)*

Configure a ratio factor for the voltage inputs when a potential transformer (PT) is in series with the voltage connections such as when you want to monitor a medium-voltage network. The default value is 1:1.

### *Current Ratio*

Configure a ratio factor for the current sensors when a current transducer (CT) is used to measure the much higher level on the primary side at a substation or step-down transformer that has a built-in metering current transformer.

The current ratio also can be used to increase the sensitivity of flexible current sensor: Wrap the iFlex sensor around the primary conductor e.g. 2-times and enter a ratio factor of 1:2 to get correct readings.

The default value is 1:1.

### *Connection Verification and Correction*

Once the measurement is configured and the voltage and current inputs are connected to the system under test, use the **Verify Connection** touch button to confirm the connection.

The verification detects:

- Too low signal
- Phase rotation for voltage and current
- Inverted current probes
- Wrong phase map

In the connection verification screen:

1. Push **F1** (Correct Digitally) to access the connection correction screen. This screen allows you to virtually swap phases and invert the current inputs instead of a manual correction.
2. If the Logger is able to determine a better phase map or polarity, push **F2** (Auto Correct) to apply the new settings.

Auto Correct is not available if the algorithm is not able to detect a better phase map or when no errors are detected.

#### *Note*

*It is impossible to detect all incorrect hook-ups automatically. You must verify the suggested modifications carefully before you apply the digital correction.*

The algorithm works in a way that creates in three phase systems a sequence with a clockwise phase rotation.



## Power

**POWER** – In the Power mode you can get the values and a live trend chart for each phase (A, B, C or L1, L2, L3) and total as:

- Active Power (P) in W
- Apparent power (S) in VA
- Non-active power (D) in var
- Power factor (PF)

Use **F2** (Fundamental/RMS) to toggle between full bandwidth power values and power of the fundamental.

In the fundamental power screen you see these values:

- Fundamental Active Power in W
- Fundamental Reactive Power in var
- Fundamental Apparent Power in VA
- Displacement Power Factor (DPF) /  $\cos\phi$

### Note

*In the user interface, the term Fundamental is sometimes shortened to “Fund.” or “h01.”*

## Logger

**LOGGER** – In Logger mode, you can:

- Configure a new logging session
- Review the data of an ongoing logging session in memory
- Review the data of a completed logging session (as long as no new session has been started)

Push **MEMORY SETTINGS** and then **F1** (Logging Sessions) to review a logging session.

### Logging Session Setup

When no logging session is active, push **LOGGER** to display the Setup Summary screen for logging. This screen lists all logging parameters such as:

- Session name
- Duration
- Interval of the average calculation
- Demand interval (not available for load studies)
- Energy costs (not available for load studies)
- Description

Go to Meter > Change Configuration to select between Load Study and Energy Study. This Configuration screen also contains the measurement configuration parameters such as Topology, current range, voltage, and current ratios. See page 28 for more information about

measurement configuration. After you review these parameters, push the **Start Logging** touch target to start recording.

If you want to modify the parameters, push the **Edit Setup** touch target. The settings are kept also during a power cycle. This allows configuring the logging session in the office and it is more convenient to avoid the time consuming task in the field.

### **Name**

The Logger auto-generates a file name with the format ES.xxx or LS.xxx.

ES ... Energy Study

LS ... Load Study

xxx ... incremental file number

The counter resets when the Logger is set to factory defaults. See page 34 for details. You can also choose a custom file name with up to 31 characters.

### **Duration**

Select the duration of the measurement from the list. The logging session stops automatically when the time duration has elapsed. A manual stop during the logging session is also available.

A memory gauge shows the memory used by old sessions in black. The memory required for the new session is shown in green. In the case where the new logging session will not fit in the available memory, the gauge turns from green to red. You can adjust the average calculation interval to fit into the available memory.

### **Interval of the average calculation**

Select the time interval when a new average value is added to the logging session. The available intervals are: 1 s, 5 s, 10 s, 30 s, 1 min, 5 min, 10 min, 15 min, 30 min.

A shorter interval provides more details at the cost of higher memory consumption.

Examples of when a short interval is useful:

- Identify duty cycle of frequently switching loads
- Energy cost calculation of production steps

The Logger recommends an interval based on the duration to get the best balance between resolution and data size.

### Demand Interval

Electrical suppliers use this interval to measure the customer demand. Select an interval to get energy costs and the maximum demand value (average power measured over a demand interval).

A value of 15 minutes is normal. If you don't know the average interval, select 5 minutes. You can recalculate other interval lengths offline using the Energy Analyze software.

*Note*

*This value is not available for load studies.*

### Energy costs

Enter the costs/kWh for demand energy. The energy costs are applied to forward energy (positive energy) using the demand interval and can be reviewed in the Logger detail screen Energy - Demand.

Energy costs can be entered using a resolution of 0.001. The currency unit is changed in Instrument Settings. See page 32 for more information.

*Note*

*This value is not available for load studies.*

### Description

Enter more details about the measurement, such as customer, location, and load-rating plate data with the virtual keyboard. This description field is limited to 127 characters.

The Energy Analyze software allows more advanced input that supports line breaks and an unlimited number of characters.

### *Logging Session Review*

When a logging session is started, or when you review a completed session, the Logging home screen is shown. During active recording, this screen can be accessed when you push .

The Logger home screen shows the progress of an active recording. The screen shows the overview chart with active power and PF for energy studies and currents for load studies. Total energy is available also in energy studies.

The screen updates with each new average calculation interval at a maximum of every 5 seconds.

From the Logger home screen you have access to:

- V, A, Hz, + (A, Hz, + for load studies)
- Power
- Energy
- Details

In the "V, A, Hz, +" , "Power" and "Energy" screens, use **F4** (Show Menu) or the cursor keys to see a list of available parameters. Use **▲▼** to select a parameter and confirm the selection with **SAVE ENTER**.

Tables update with each new average calculation interval at a maximum of every 5 seconds. Push **F2** (Refresh) to update Charts on request.

### V, A, Hz, + (Load studies: A, Hz, +)

You can determine the average value measured over the logging duration as well as minimum/maximum values with high resolution.

Parameter	Min	Max	Resolution
V	+	+	Full cycle (typ. 20 ms @ 50 Hz, 16.7 ms @ 60 Hz)
A	-	+	Half cycle (typ. 10 ms @ 50 Hz, 8.3 ms @ 60 Hz)
Hz	+	-	200 ms
AUX	+	+	200 ms
THD-V/THD-A	-	+	200 ms

The algorithm to calculate Voltage min/max values is in accordance to established power quality standards to detect dips, swells, and interruptions.

Watch for values exceeding  $\pm 15\%$  of the nominal voltage. This is an indicator of power quality problems.

High maximum values on Currents can be an indicator for tripping circuit breakers.

Push **F1** (Graph) to display the measured values in a chart. The table on the right side of the screen shows the highest and lowest value of the graph measured with the average calculation interval. Triangular indicators point to the measurement value.

### Power

#### Note

*Not available on load studies without a nominal voltage.*

Review the power values in tabular format and as a time chart. Depending on the power parameter or the average value measured over the logging duration, additional values are available:

Parameter	Min/ Max	Top 3	Top 3 Forward/ Reverse
Active Power (W)	-	-	+/+
Apparent Power (VA)	-	+	-
Non-active Power (var)	-	-	+/+
Power Factor	+	-	-
Active Power fund. (W)	-	-	+/+
Apparent Power fund. (VA)	-	+	-
Reactive Power (var)	-	-	+/+
Displacement Power Factor/cos $\phi$	+	-	-

For all power values, except PF and DPF, the three highest values during the logging session are available. Use **F2** (Reverse Power/Forward Power) to toggle between Top-3 forward and Top-3 reverse values.

Push **F1** (Graph) to display the measured values in a chart. The table on the right side of the screen shows the highest and lowest value of the graph measured with the average calculation interval. Triangular indicators point to the measurement value.

### Energy

#### Note

*Not available on load studies without a nominal voltage.*

Determine the energy consumed/delivered since the logging session has been started.

Parameter	Forward/Reverse Energy	Total Energy
Active Energy (Wh)	+/+	+
Apparent Energy (Vah)	-/-	+
Reactive Energy (varh)	-/-	+

The Demand screen shows the values for:

- Consumed energy (= forward energy) in Wh
- Maximum Demand in W. Maximum demand is the highest active power measured over the demand interval and is often part of the contract with the electricity supplier.
- Energy cost. The currency can be configured in instrument settings. See page 32 for more information.

### Details

The details screen provides an overview of the logging setup. During an active session or when reviewing an already completed session, the description can be modified with the **Edit Setup** touch target. Once a session is complete, you can recalculate the total energy costs with a new configuration that has a different energy cost/kWh.

Push **View Configuration** to review the measurement configuration for the logging session.

### Memory/Settings Button

In this menu you can:

- Review the data from completed logging sessions
- Manage the data memory
- Copy measurement data to the USB flash drive
- Erase measurements
- Make adjustments to the instrument settings

### Logging Sessions

The list of stored logging sessions is available with **F1** (Logging Sessions). Push **▲▼** to move the screen highlight to the logging session of interest. Additional information such as start and end time, duration, logging description, and file size are shown.

1. Push **SAVE ENTER** to review the logging session. See *View Logging Sessions* for more details.

#### Note

*It is not possible to review a completed logging session when another session is active.*

2. Push **F1** (Delete) to remove the selected logging session. Push **F2** to remove all logging sessions.

#### Note

*An active logging session cannot be deleted. Stop the logging session before you delete.*

3. Push **F3** (Save to USB) to copy the selected logging session to an attached USB flash drive. The session is stored on the USB flash drive in the folder:

\\Fluke1730\<serial number>\sessions

### Screen Capture

In this screen you can review, erase, and copy saved screens to a USB flash drive.

1. Push **MEMORY SETTINGS**.
2. Push **F2** (Screen Capture) to show the list of all screens. See *Basic Navigation* for information about how to capture screens.
3. Push **▲ ▼** to move the screen highlight to a screen of interest. A thumbnail image of the screen is shown for easy identification.
4. Use **F1** (Delete) to delete the selected screen. Push **F2** to delete all screens.
5. Push **F3** or (Save All to USB) to copy all screens to an attached USB flash drive.

### Instrument Settings

The Logger has settings for language, date and time, phase information, firmware version and update, and calibration.

To change the settings:

1. Push **MEMORY SETTINGS**.
2. Push **F4** (Instrument Settings).

### Language

The user interface of the Logger is available in Czech, Chinese, English, French, German, Italian, Korean, Polish, Portuguese, Russian, Spanish, and Turkish.

To change the display language:

1. Push **MEMORY SETTINGS**.
2. Push **▲ ▼** to move the screen highlight to language field.
3. Push **SAVE ENTER** to activate language field.
4. Push **▲ ▼** to move through the language list.
5. Push **SAVE ENTER** to activate the new language.





The language immediately updates on the screen.

### Phase Color/Phase Labels

The phase colors are configurable to match with the connector panel decal. Five schemes are available:

	A/L1	B/L2	C/L3	N
US	black	red	blue	white
Canada	red	black	blue	white
EU	brown	black	grey	blue
UK (old)	red	yellow	blue	black
China	yellow	green	red	blue

To change the phase color/phase labels:





1. Push .
2. Push **F4** (Instrument Settings).
3. Push  to highlight Phases. Push  or touch **Phases** target.
4. Select one of the available schemes.
5. Push **F2** to toggle the phase label between **A-B-C** and **L1-L2-L3**.
6. Push  to confirm the selection.

### Date/Time Zone



The logger stores the measurement data in universal time coordinate (UTC) to ensure continuity in time and accounts for time changes due to daylight saving time (DST).

To display the time stamps of the measurement data correctly, it is required to set the time zone. The Logger adjusts automatically to DST. For example, a 1-week measurement started on 2-Nov-2013 8:00 am ends on 9-Nov-2013 08:00 am even though the clock was set back on 3-Nov-2013 from 02:00 to 01:00.

#### To set the time zone:

1. Push .
2. Push  to highlight or touch **Time Zone** target.
3. Push .
4. Select the regions/continents.
5. Push .
6. Continue to select the country/city/time zone until the time zone configuration is done and the Instrument Settings menu shows.

#### To set the date format:

1. Push  to highlight the **Date Format** target.
2. Push .
3. Select one of the available date formats.

4. Push **F2** to toggle between a 12 hour or 24 hour format. A preview of the configured date format shows on the display.
5. Push **SAVE ENTER** to confirm the selection.

#### To change the time:

1. Use the **+** and **-** touch targets for each field.
2. Push **SAVE ENTER** to confirm the change and exit the screen.

### Currency

The currency symbol used for energy cost values is configurable.

#### To set the currency:

1. Push **MEMORY SETTINGS**.
2. Push **F4** (Instrument Settings).
3. Push **▲ ▼** to highlight or touch **Currency**.
4. Select one of the currency symbols and push **SAVE ENTER**.
5. If a currency is not in the list, select **Custom** and push **F4** or touch **Edit Custom** target.
6. Enter a three-letter currency code with the keyboard and accept with **F4**.
7. Push **SAVE ENTER** to confirm the selection.

### Touch Screen Calibration

The touch screen has been calibrated at the factory before shipment. In case you do experience misalignment with the touch targets, use the touch screen calibration feature.

To calibrate:

1. Push **MEMORY SETTINGS**.
2. Push **F4** (Instrument Settings).
3. Push **F1** (Tools).
4. Push **▲ ▼** to highlight the **Touch Screen Calibration** target.
5. Push **SAVE ENTER** to open the calibration screen. Or, touch the **Touch Screen Calibration** target to open the calibration screen.
6. Follow the on-screen instructions to touch five targets in sequence.

The Logger reboots to complete the calibration.

#### Note

*Touch screen calibration is not available when a logging session is active.*



## Firmware Update



To update:

1. Take a USB flash drive with at least 40 MB of free space available and create a folder called "Fluke1730" (no spaces in file name).

*Note*

*Make sure the USB is formatted with FAT or FAT32 file system.*

In Windows USB flash drives  $\geq 32$ GB can be formatted with FAT/FAT32 only by using 3rd party tools.



2. Copy the firmware file (\*.bin) into this folder.
3. Make sure the Logger is powered from mains and operating.
4. Plug the flash drive into the Logger. The USB Transfer screen pops up and offers the firmware update.
5. Push   to select the firmware update and push .
6. Follow the instructions. When the firmware update is complete the Logger reboots automatically.

*Note*

*A firmware update deletes all user data such as measurement data and screen captures.*

This firmware update works only when the firmware version on the USB flash drive is newer than the installed version.

To install the same version or an older version:





1. Go to Memory/Settings menu.
2. Push  or **Instrument Settings**.
3. Push  or **Tools**.
4. Select Update firmware and follow the on-screen instructions.

*Note*

*If more than one firmware file (\*.bin) is located in the \Fluke1730 folder, the newest version is used for the update.*

## Firmware Version







To find the firmware version installed on your Logger:

1. Go to Memory/Settings menu.
2. Push  or **Instrument Settings**.
3. Push  or **Tools**.
4. Push   to highlight or touch **Instrument Information** target.
5. Push  to exit the screen.

### **Reset to Factory Defaults**

The reset function deletes all user data, such as logging sessions and screen captures, and sets the instrument settings to default values. It also enables the first-time use wizard the next time the instrument boots.

To reset:



1. Push .
2. Push  (Instrument Settings).
3. Push  (Tools).
4. Push   to highlight or touch **Reset to Factory Defaults** target.
5. Push  to continue. A display message will prompt you to continue or cancel the reset.

### **First-time Use/Setup Wizard**

To start the Logger:

1. Attach the power supply to the Logger or use the DC power cord to connect the Power Supply with the Logger.
2. Connect the power cord into the power supply.

The Logger starts up in <20 seconds and the Setup Wizard starts.

3. Pick the language (see page 30).
4. Push  (Next) or  to navigate to the next page.
5. Push  (Cancel) to close the setup wizard. If you cancel, the setup wizard starts again on next startup of the logger.
6. Pick the work standards for your region. This action selects the color codes and the phase descriptor (A, B, C or L1, L2, L3).  

This is the best time to apply the correlating decal on the connector panel. The decal helps you to quickly identify the appropriate voltage test lead and current probe for the different phases and neutral.
7. Attach the color clips to the current probe cables.
8. Pick your time zone and date format. Confirm that the correct date and time are shown on-screen.
9. Pick the currency sign or currency code.

The Logger is now ready for the first measurements or energy study.

*Note*

*Be aware that for power measurements in 3-phase systems:*

- *Total Active Power (W) is the sum of the individual phases*
- *Total Apparent Power (VA) also includes the neutral current that can result in a very different result than the sum of the three phases. This is especially noticeable when a signal is connected to all three phases (for example, a calibrator) the total value is approximately 41% higher than the sum of each phase.*
- *Total Fundamental Power (W) only delivers the sum of each phase when the phase rotation is clockwise. It is zero when the phase rotation is counter-clockwise.*

*For more information, see the white paper, Measurement Theory Formulas, at [www.fluke.com](http://www.fluke.com) for a list of formulas.*

## **First Measurements**

At the energy study site, look at the information in the panel and the rating plates on the machines. Based on knowledge of the electrical supply in the facility, determine the configuration.

To start measurements:

1. Connect the Logger to mains power.

*Note*

*See page 15 if you want to power the Logger from the measurement line.*

The Logger starts and shows the Meter screen with Volts, Amps and Hz readings.

2. Push **Change Configuration**. Confirm the study type and the wiring configuration is correct. For most applications the current range is set to Auto and the voltage and current ranges are 1:1.
3. Push **Configuration Diagram** for guidance on the voltage test lead and current probe connections.
4. Plug the voltage test leads into the Logger.
5. Use the Thin-Flexi current probes and plug the phase A current probe into the phase A/L1 input jack on the logger, the phase B/L2 current probe into the phase B/L2 input jack on the logger, and the phase C/L3 current probe into the phase C/L3 input jack on the logger.
6. Apply the iFlex Probes to the wires in the electrical panel. Make sure the arrow on the probe points to the load.
7. Connect the voltage test leads to neutral, phase A/L1, phase B/L2, and phase C/L3.

8. With all of the connections done, check that the voltages for phases A/L1, B/L2, and C/L3 are as expected.
9. Read the current measurements for phases A/L1, B/L2, and C/L3.
10. Push **Verify Connection** to check and correct the phase rotation, phase mapping, and polarity of current probes.
11. Push **Live-Trend** to display a chart of the last 7 minutes.  
In most installations a clockwise rotation is used.
12. Push **POWER** to determine the power values, especially active power and power factor.
13. Push **Live-Trend** to display a chart of the last 7 minutes.
14. Push **SAVE ENTER** for 3 seconds to take a snapshot of the measurements.
15. Push **LOGGER** and change the default configuration with **Edit Setup**.  
Typical setup:
  - 1 week duration
  - 1 minute for average calculation interval
  - 15 minutes for demand interval
16. Push **Start Logging**.  
You can review the live data with **METER** or **POWER**. Return to the active logging session with **LOGGER**. Once the

logging session is completed it is accessible in Memory/Settings - Logging Sessions.

17. Review the logged data using the softkeys **V, A, Hz, +, Power, and Energy**. See page 28 for more information.
18. To transfer and analyze the data using the PC software, attach the USB flash drive to the Logger and copy the logging session and screenshot.

*Note*

*You can also use the USB cable to transfer the measurement data but the transfer of the screenshot via cable is not supported.*

To analyze the data using the PC software:

1. Attach the USB flash drive to a PC with Energy Analyze installed.
2. In the software, click **Download** and copy the logging session from the USB flash drive.
3. Open the downloaded session and view the measured data.
4. Go to the Project Manager tab and click **Add Image** to add the screenshot.

For more information about how to use the Energy Analyze, see the online help for the software.

## **Maintenance**

If the Logger is used appropriately it does not require special maintenance or repair. Maintenance work may be executed only by trained and qualified personnel. This work may only be done at a company related service center within the guarantee period. See [www.fluke.com](http://www.fluke.com) for locations and contact information of Fluke Service Centers worldwide.

### **⚠⚠ Warning**

**To prevent possible electrical shock, fire, or personal injury:**

- **Do not operate the Product with covers removed or the case open. Hazardous voltage exposure is possible.**
- **Remove the input signals before you clean the Product.**
- **Use only specified replacement parts.**
- **Have an approved technician repair the Product.**

## **How to Clean**

### **⚠ Caution**

**To avoid damage, do not use abrasives or solvents on this instrument.**

If the Logger is dirty, wipe it off carefully with a damp cloth (without cleaning agents). Mild soap may be used.

## **Battery Replacement**

The Logger has an internal rechargeable Lithium-ion battery.

To replace the battery:

1. Remove the Power Supply.
2. Unscrew the four screws and remove the battery door.
3. Replace the battery.
4. Fasten the battery door.

### **⚠ Caution**

**To prevent damage to the Product, use only original Fluke batteries.**

## **Calibration**

As an additional service we offer the regular examination and calibration of your Logger. The recommended calibration cycle is 2 years.

More information about how to contact Fluke is on page 2.

## Service and Parts

Replacement parts and accessories are listed in Table 6 and shown in Figure 9. To order parts and accessories, see *How to Contact Fluke*.

**Table 6. Replacement Parts**

Ref.	Description	Qty.	Fluke Part or Model Number
①	Power Supply	1	4212737
②	Battery Door	1	4388072
③	Battery Pack, Li ion 3.7 2500 mAh	1	4146702
④	USB Cable	1	1671807
⑤	Input Decal, country specific (US, Canada, Europe/UK, UK/old, China)	1	see Figure 8
⑥	Line Cord, country specific (N. American, Europe, UK, Australia, Japan, India/S. Africa, Brazil)	1	see Figure 1
⑦	Test Lead 0.10 m Red, 1000 V Cat III	1	4382584
⑧	Test Lead 2 m Red, 1000 V Cat III	1	4382591
⑨	Color-coded Wire Clips	1 set	4394925
⑩	USB Flash Drive	1	4298561
⑪	Users Manual on USB Flash Drive	1	NA

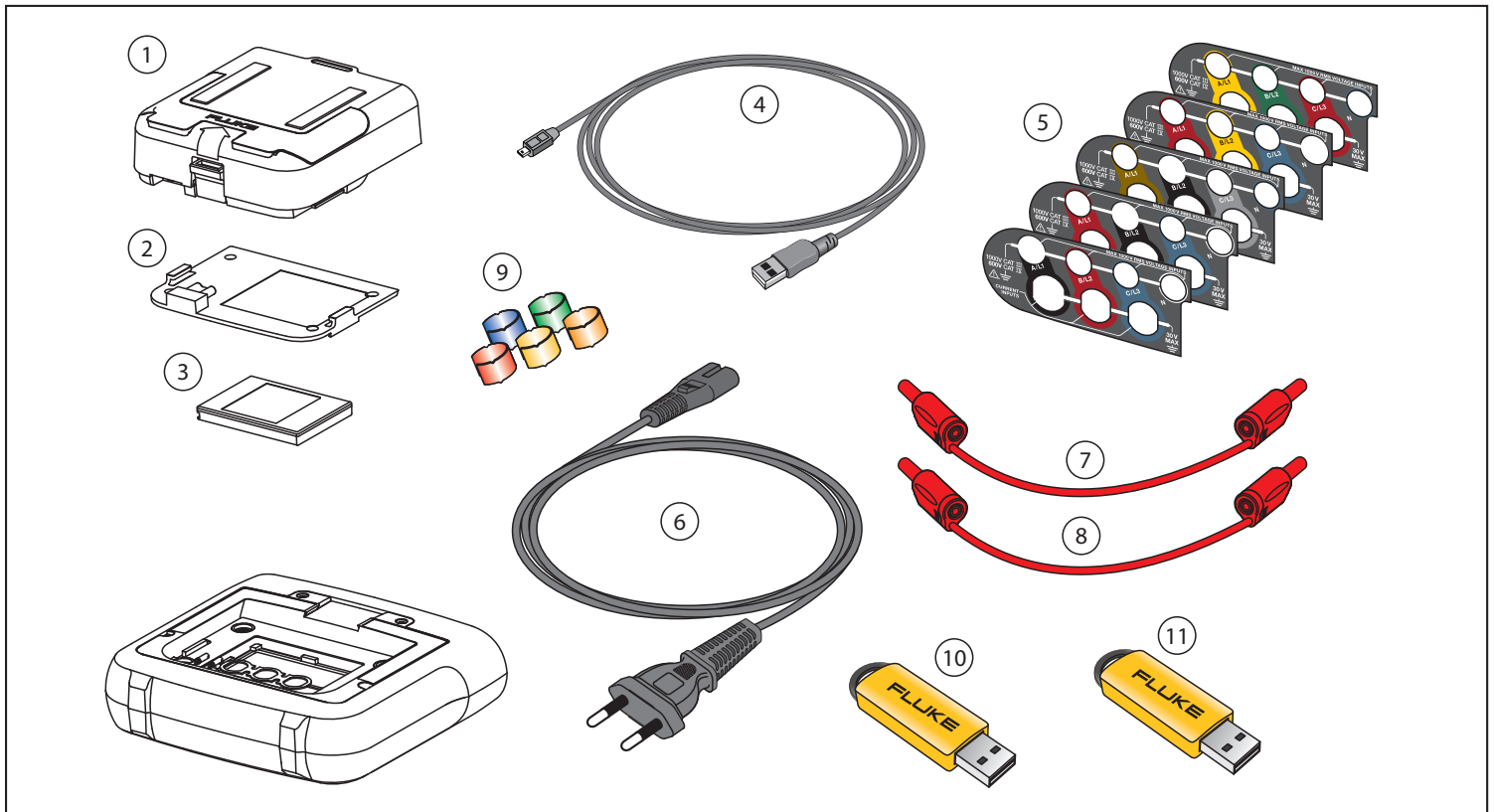

hcf060.eps

Figure 9. Replacement Parts

## Energy Analyze Software

The 1730 Energy Logger includes the Fluke Energy Analyze software that lets you do tasks from a computer.

You can:

- Download campaign results for further processing and archiving.
- Analyze energy or load profiles, including zoom-in and zoom-out on details.
- Add comments, annotations, pictures, and other supplementary information to campaign data.
- Overlay data from different campaigns to identify and document changes.
- Create a report from the analysis you performed.
- Export measurement results for further processing using a third party tool.

## System Requirements

The computer hardware requirements for the Energy Analyze software are:

- Free Hard Disk space 50 MB,  
>10 GB (for measurement data) recommended
- Installed Memory:
  - 1 GB minimum for 32-bit systems
  - ≥2 GB recommended for 32-bit systems,  
≥4 GB recommended for 64-bit systems
- Monitor, 1280 x 1024 (@4:3) or 1440 x 900 (@16:10), wide-screen (16:10) at higher resolution recommended
- USB 2.0 ports
- WinXP 32-bit, Windows 7 32/64-bit, Windows 8 32/64-bit.

### *Note*

*Windows 7 Starter edition and Windows 8 RT are not supported.*



### **PC Connections**

To connect the computer to the Logger:

1. Power on the computer and the Logger.
2. Connect the USB cable to the USB ports of the computer and the Logger as shown in Figure 10.
3. Install the Energy Analyze Software.

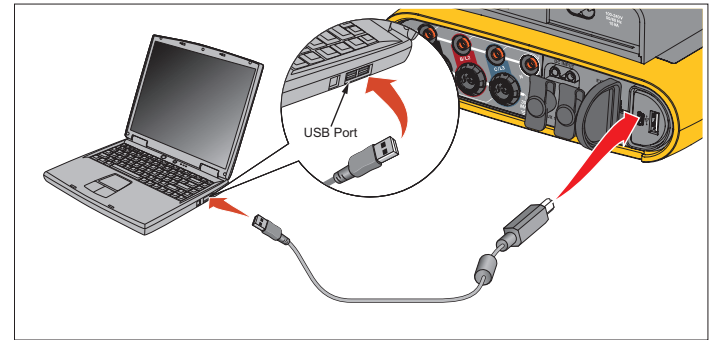

hcf024.eps

**Figure 10. Energy Logger to PC Connections**

See the *Energy Analyze Online Help* for information about how to use the software.

## Wiring Configurations

V, A, Hz, +

		Single Phase Single Phase IT	Split Phase (2P-3W)	3-ph Wye 3-ph Wye IT (3P-4W)	Balanced 3-ph Wye	3-ph Delta (3P-3W)	3-ph Delta Open Leg (3P-3W)	Balanced 3-ph Delta	2 Element Delta Aron/Blondel
$V_{AN}^{[1]}$	V	•	•	•	•				
$V_{BN}^{[1]}$	V		•	•	○				
$V_{CN}^{[1]}$	V			•	○				
$V_{AB}^{[1]}$	V		• <sup>[2]</sup>	• <sup>[2]</sup>	○ <sup>[2]</sup>	•	•	•	•
$V_{BC}^{[1]}$	V			• <sup>[2]</sup>	○ <sup>[2]</sup>	•	•	○	•
$V_{CA}^{[1]}$	V			• <sup>[2]</sup>	○ <sup>[2]</sup>	•	•	○	•
$I_A$	A	•	•	•	•	•	•	•	•
$I_B$	A		•	•	○	•	•	○	X
$I_C$	A			•	○	•	•	○	•
f	Hz	•	•	•	•	•	•	•	•
Aux 1, 2	mV	•	•	•	•	•	•	•	•

THD $V_A$ <sup>[3]</sup>	%	●	●	●	●				
THD $V_B$ <sup>[3]</sup>	%		●	●	○				
THD $V_C$ <sup>[3]</sup>	%			●	○				
THD $V_{AB}$ <sup>[3]</sup>	%					●	●	●	●
THD $V_{BC}$ <sup>[3]</sup>	%					●	●	○	●
THD $V_{CA}$ <sup>[3]</sup>	%					●	●	○	●
THD $I_A$	%	●	●	●	●	●	●	●	●
THD $I_B$	%		●	●	○	●	●	○	●
THD $I_C$	%			●	○	●	●	○	●
<p>● Measured values</p> <p>[1] Simulated in load studies if <math>U_{nom}</math> is specified</p> <p>[2] Secondary displayed values</p> <p>[3] Not available in load studies</p> <p>X Calculated values</p> <p>○ Simulated values (derived from phase 1)</p>									

Power

		Single Phase Single Phase IT	Split Phase (2P- 3W)	3-ph Wye (3P- 4W)	Balanced 3-ph Wye	3-ph Delta (3P- 3W)	3-ph Delta Open Leg (3P-3W)	Balanced 3-ph Delta	2 Element Delta Aron/Blondel
$P_A, P_{A \text{ fund}}^{[3]}$	W	●	●	●	●				
$P_B, P_{B \text{ fund}}^{[3]}$	W		●	●	○				
$P_C, P_{C \text{ fund}}^{[3]}$	W			●	○				
$P_{\text{Total}}, P_{\text{Total fund}}^{[3]}$	W		●	●	○	●	●	●	●
$Q_A, Q_{A \text{ fund}}^{[3]}$	var	●	●	●	●				
$Q_B, Q_{B \text{ fund}}^{[3]}$	var		●	●	○				
$Q_C, Q_{C \text{ fund}}^{[3]}$	var			●	○				
$Q_{\text{Total}}, Q_{\text{Total fund}}^{[3]}$	var			●	○	●	●	●	●
$S_A^{[1]}$	VA	●	●	●	●				
$S_B^{[1]}$	VA		●	●	○				
$S_C^{[1]}$	VA			●	○				
$S_{\text{Total}}^{[1]}$	VA		●	●	○	●	●	●	●
$PF_A^{[3]}$		●	●	●	●				
$PF_B^{[3]}$			●	●	○				
$PF_C^{[3]}$				●	○				
$PF_{\text{Total}}^{[3]}$			●	●	○	●	●	●	●
<p>● Measured values</p> <p>[1] Simulated in load studies if <math>U_{\text{nom}}</math> is specified</p> <p>[2] Secondary displayed values</p> <p>[3] Not available in load studies</p> <p>X Calculated values</p> <p>○ Simulated values (derived from phase 1)</p>									

## Specifications

### General Specifications

**Color LCD Display** ..... 4.3-inch active matrix TFT, 480 pixels x 272 pixels, resistive touch panel. Text and graphics in color.

#### Power/Charging/LED Indicator

#### Warranty

1730 and Power Supply ..... 2 years (battery not included)  
Accessories ..... 1 year

**Calibration Cycle** ..... 2 years

#### Dimensions

1730 ..... 19.8 cm x 16.7 cm x 5.5 cm (7.8 in x 6.6 in x 2.2 in)  
Power Supply ..... 13.0 cm x 13.0 cm x 4.5 cm (5.1 in x 5.1 in x 1.8 in)  
1730 with power supply attached ..... 19.8 cm x 16.7 cm x 9 cm (7.8 in x 6.6 in x 3.5 in)

#### Weight

1730 ..... 1.1 kg (2.5 lb)  
Power Supply ..... 400 g (0.9 lb)

**External Protection** ..... Holster, Kensington lock

### Environmental Specifications

**Operating Temperature** ..... -10 °C to 50 °C (14 °F to 122 °F)

**Storage Temperature** ..... -20 °C to 60 °C (-4 °F to 140 °F), with battery: -20 °C to 50 °C (-4 °F to 122 °F)

**Operating Humidity** ..... <10 °C (<50 °F) non condensing  
10 °C to 30 °C (50 °F to 86 °F) ≤95 %  
30 °C to 40 °C (86 °F to 104 °F) ≤75 %  
40 °C to 50 °C (104 °F to 122 °F) ≤45 %

**Operating Altitude** ..... 2,000 m (up to 4,000 m derate to 1000 V CAT II/600 V CAT III/300 V CAT IV)

**Storage Altitude** ..... 12,000 m

**IP Rating** ..... IEC 60529:IP50, in connected condition with protection caps in place.

**Vibration** ..... MIL 28800E, Type 3, Class III, Style B

**Safety** ..... IEC 61010-1: Overvoltage CAT IV, Measurement 1000 V CAT III / 600 V CAT IV, Pollution Degree 2

**Electromagnetic Environment** ..... IEC 61326-1: Industrial

**Electromagnetic Compatibility** ..... Applies to use in Korea only. Class A Equipment (Industrial Broadcasting & Communication Equipment) <sup>[1]</sup>

[1] This product meets requirements for industrial (Class A) electromagnetic wave equipment and the seller or user should take notice of it. This equipment is intended for use in business environments and not to be used in homes.

**Radio Frequency Emissions**..... IEC CISPR 11: Group 1, Class A.  
*Group 1* has intentionally generated and/or use conductively coupled radio-frequency energy which is necessary for the internal functioning of the equipment itself.  
*Class A* equipment is suitable for use in non-domestic locations and/or directly connected to a low-voltage power supply network.

## Electrical Specifications

### Power Supply

Voltage Range ..... nominal 100 V to 500 V (85 V min to 550 V max) using safety plug input  
Mains Power ..... nominal 100 V to 240 V (85 V min to 265 V max) using IEC 60320 C7 input (figure 8 power cord)  
Power consumption ..... Maximum 50 VA (max. 15 VA when powered using IEC 60320 input)  
Standby Power ..... <0.3 W only when powered using IEC 60320 input  
Efficiency .....  $\geq 68.2\%$  (in accordance with energy efficiency regulations)  
Mains Frequency ..... 50/60 Hz  $\pm 15\%$   
Battery Power ..... Li-ion 3.7 V, 9.25 Wh, customer-replaceable  
On-Battery Runtime ..... up to 4 hr (up to 5.5 hr in energy saving mode)  
Charging Time ..... <6 hr

### Data Acquisition

Resolution ..... 16-bit synchronous sampling  
Sampling Frequency ..... 5120 Hz  
Input Signal Frequency ..... 50/60 Hz (42.5 to 69 Hz)  
Wiring Configurations ..... 1- $\Phi$ , 1- $\Phi$  IT, Split phase, 3- $\Phi$  wye, 3- $\Phi$  wye IT, 3- $\Phi$  wye balanced, 3- $\Phi$  delta, 3- $\Phi$  Aron/Blondel (2-element delta), 3- $\Phi$  delta open leg, Currents only (load studies)

### Interfaces

USB-A ..... File transfer via USB Flash Drive, Firmware updates, max. supply current: 120 mA  
USB-mini ..... Data download device to PC  
Extension port ..... Accessories

Total Harmonic Distortion (THD) ..... THD for voltage and current is calculated on 25 harmonics  
 Averaging Time ..... User selectable: 1 sec, 5 sec, 10 sec, 1 min, 5 min, 10 min, 15 min, 30 min  
 Demand Interval ..... User selectable: 5 min, 10 min, 15 min, 20 min, 30 min  
 Data Storage ..... Internal flash memory (not user replaceable)  
 Memory Size ..... Typical 20 logging sessions of 10 weeks with 10-minute intervals<sup>[1]</sup>

**Logging Period**

<b>Averaging Period</b>	<b>Recommended for 20 sessions</b>	<b>Logging Period for 1 session</b>
1 sec	3 hr	2.5 days
5 sec	15 hr	12 days
10 sec	28 hr	24 days
30 sec	3.5 days	10 weeks
1 min	7 days	20 weeks
5 min	5 weeks	2 years
10 min	10 weeks	>2 years
15 min	3.5 months	>2 years
30 min	7 months	>2 years

[1] The number of possible logging sessions and logging period depends on user requirements.

**Voltage Inputs**

Number of Inputs .....	4 (3 phases and neutral)
Maximum Input Voltage .....	1000 V <sub>rms</sub> (1700 V <sub>pk</sub> ) phase to neutral
Input Impedance .....	10 MΩ each phase to neutral
Bandwidth (–3 dB) .....	2.5 kHz
Scaling .....	1:1, 10:1, 100:1, 1000:1, variable

**Current Inputs**

Number of Inputs .....	3, mode selected automatically for attached sensor
Current Sensor Output Voltage	
Clamp .....	500 mV <sub>rms</sub> / 50 mV <sub>rms</sub> ; CF 2.8
Rogowski Coil .....	150 mV <sub>rms</sub> / 15 mV <sub>rms</sub> at 50 Hz, 180 mV <sub>rms</sub> / 18 mV <sub>rms</sub> at 60 Hz; CF 4; all at nominal probe range
Range .....	1 A to 150 A / 10 A to 1500 A with iFlex1500-12
	3 A to 300 A / 30 A to 3000 A with iFlex3000-24
	6 A to 600 A / 60 A to 6000 A with iFlex6000-36
	40 mA to 4 A / 0.4 A to 40 A with 40 A clamp i40s-EL
Bandwidth (–3 dB) .....	1.5 kHz
Scaling .....	1:1, variable

**Auxiliary Inputs**

Number of Inputs .....	2
Input Range .....	0 to ±10 V dc, 1 reading/s



**Accuracy at Reference Conditions**

Parameter		Range	Resolution	Intrinsic Accuracy at Reference Conditions (% of Reading + % of Range)
Voltage		1000 V	0.1 V	$\pm(0.2 \% \text{ of rdg.} + 0.01\%)$
Direct Input	Rogowski Mode	15 mV	0.01 mV	$\pm(0.3 \% + 0.02 \%)$
		150 mV	0.1 mV	$\pm(0.3 \% + 0.02 \%)$
	Clamp Mode	50 mV	0.01 mV	$\pm(0.2 \% + 0.02 \%)$
		500 mV	0.1 mV	$\pm(0.2 \% + 0.02 \%)$
1500 A iFlex		150 A	0.1 A	$\pm(1 \% + 0.02 \%)$
		1500 A	1 A	$\pm(1 \% + 0.02 \%)$
3000 A iFlex		300 A	1 A	$\pm(1 \% + 0.03 \%)$
		3000 A	10 A	$\pm(1 \% + 0.03 \%)$
6000 A iFlex		600 A	1 A	$\pm(1.5 \% + 0.03 \%)$
		6000 A	10 A	$\pm(1.5 \% + 0.03 \%)$
40 A		4 A	1 mA	$\pm(0.7 \% + 0.02 \%)$
		40 A	10 mA	$\pm(0.7 \% + 0.02 \%)$
Frequency		42.5 Hz to 69 Hz	0.01 Hz	$\pm 0.1 \%$
Aux Input		$\pm 10 \text{ Vdc}$	0.01 V	$\pm(0.2 \% + 0.02 \%)$
Voltage Min/Max		1000 V	0.1 V	$\pm(1 \% + 0.1 \%)$
Current Min/Max		defined by accessory	defined by accessory	$\pm(5 \% + 0.2 \%)$
THD on Voltage		1000 %	0.1 %	$\pm(2.5 \% + 0.05 \%)$
THD on Current		1000 %	0.1 %	$\pm(2.5 \% + 0.05 \%)$
Power Factor		$0 \leq \text{PF} \leq 1$	0.01	$\pm 0.025$
Cos $\phi$ /DPF		$0 \leq \text{Cos}\phi \leq 1$	0.01	$\pm 0.025$

Intrinsic Uncertainty $\pm$ (% of reading + % of range) <sup>[1]</sup>						
Parameter	Influence Quantity	Direct Input	iFlex1500-12	iFlex3000-24	iFlex6000-36	i40S-EL
			150A/1500A	300A/3000A	600/6000A	4A/40A
Active Power P	PF $\geq$ 0.99	0.5 % + 0.005 %	1.2 % + 0.005 %	1.2 % + 0.0075 %	1.7 % + 0.0075 %	1.2 % + 0.005 %
	0.5 <PF <0.99	0.5 % + 3 x (1-PF) + 0.005 %	1.2 % + 7 x (1-PF) + 0.005 %	1.2 % + 7 x (1-PF) + 0.0075 %	1.7 % + 7 x (1-PF) + 0.0075 %	1.2 % + 10 x (1-PF) + 0.005 %
Apparent Power S, S fund.	0 $\leq$ PF $\leq$ 1	0.5 % + 0.005 %	1.2 % + 0.005 %	1.2 % + 0.0075 %	1.7 % + 0.0075 %	1.2 % + 0.005 %
Reactive Power N, Q fund.	0 $\leq$ PF $\leq$ 1	2.5 % of measured apparent power				
Additional uncertainty in % of range <sup>[1]</sup>	U >250V	0.015 %	0.015 %	0.0225 %	0.0225 %	0.015 %

[1] Range = 1000V x Irange

Reference Conditions:

- Environmental: 23 °C  $\pm$ 5 °C, instrument operating for at least 30 minutes, no external electrical/magnetic field, RH <65 %
- Input Conditions: Cos $\Phi$ /PF=1, Sinusoidal signal f=50/60 Hz, power supply 110V/230V  $\pm$ 10 %.
- Current and power specifications: Input voltage 1ph: 120V/230V or 3ph wye/delta: 230V/400V
- Input Current: I > 10 % of Irange
- Primary conductor of clamps or Rogowski coil in center position
- Temperature Coefficient: Add 0.1 x specified accuracy for each degree C above 28 °C or below 18 °C

### **iFlex Probe Specifications**

**Measuring range**

iFlex 1500-12.....	1 to 150 A ac / 10 to 1500 A ac
iFlex 3000-24.....	3 to 300 A ac / 30 to 3000 A ac
iFlex 6000-36.....	6 to 600 A ac / 60 to 6000 A ac
Nondestructive current .....	100 kA (50/60 Hz)

**Intrinsic Error at reference condition<sup>[1]</sup>**

.....  $\pm 0.7\%$  of reading

**Accuracy 1730 + iFlex**

iFlex 1500-12 & iFlex 3000-24.....  $\pm(1\%$  of reading + 0.02 % of range)

iFlex 6000-36.....  $\pm(1.5\%$  of reading + 0.03 % of range)

**Temperature Coefficient over operating temperature range**

iFlex 1500-12 & iFlex 3000-24..... 0.05 % of reading / °C (0.09 % of reading / °F)

iFlex 6000-36..... 0.1 % of reading / °C (0.18 % of reading / °F)

Positioning error with position of conductor in the probe window (see Figure 11)

	<b>iFlex1500-12, iFlex3000-24</b>	<b>iFlex6000-36</b>
<b>Probe Window A</b>	$\pm(1\%$ of reading + 0.02 % of range)	$\pm(1.5\%$ of reading + 0.03 % of range)
<b>Probe Window B</b>	$\pm(1.5\%$ of reading + 0.02 % of range)	$\pm(2.0\%$ of reading + 0.03 % of range)
<b>Probe Window C</b>	$\pm(2.5\%$ of reading + 0.02 % of range)	$\pm(4\%$ of reading + 0.03 % of range)

External magnetic field rejection in reference to external current (with cable >100 mm from the head-coupling and r-coil)..... 40 dB  
Phase shift.....  $< \pm 0.5^\circ$

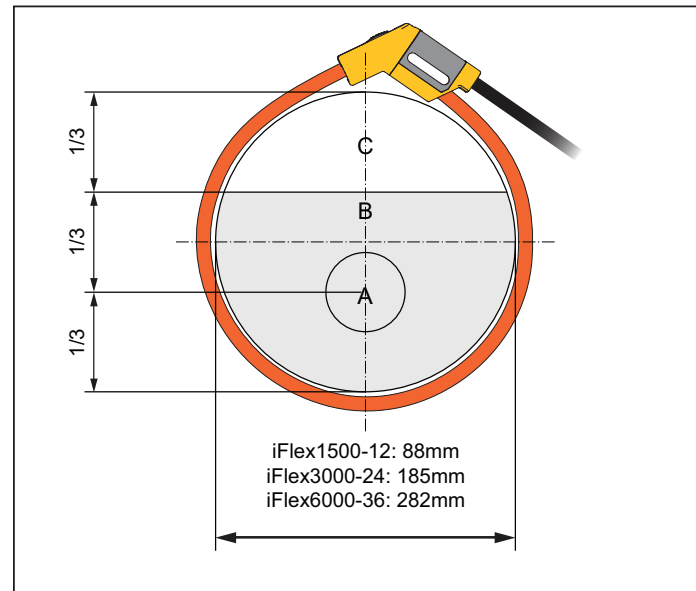

hctf057.eps

**Figure 11. iFlex Probe Window**

Bandwidth..... 10 Hz to 2.5 kHz  
Frequency derating.....  $I \times f \leq 385$  kA Hz  
Working Voltage..... 1000V CATIII, 600V CATIV

**[1] Reference Condition:**

- Environmental: 23 °C  $\pm 5$  °C, no external electrical/magnetic field, RH 65 %
- Primary conductor in center position

Transducer length	
iFlex 1500-12 .....	305 mm (12 in)
iFlex 3000-24 .....	610 mm (24 in)
iFlex 6000-36 .....	915 mm (36 in)
Transducer cable diameter .....	
	7.5 mm (0.3 in)
Minimum bending radius.....	
	38 mm (1.5 in)
Output cable length	
iFlex 1500-12 .....	2 m (6.6 ft)
iFlex 3000-24 & iFlex 6000-36.....	3 m (9.8 ft)
Weight	
iFlex 1500-12 .....	115 g
iFlex 3000-24 .....	170 g
iFlex 6000-36 .....	190 g
Material	
Transducer cable .....	TPR
Coupling.....	POM + ABS/PC
Output cable .....	TPR/PVC
Operating Temperature .....	
	-20 °C to +70 °C (-4 °F to 158°F) temperature of conductor under test shall not exceed 80°C (176°F)
Storage temperature .....	
	-40 °C to +80 °C (-40 °F to 176 °F)
Operating relative humidity, .....	
	15 % to 85 % noncondensing
IP Rating .....	
	IEC 60529:IP50
Operating Altitude .....	
	2000 m (6,500 ft) up to 4000 m (13,000 ft) derate to 1000 V CAT II/600 V CAT III/300 V CAT IV
Storage Altitude .....	
	12 km (40,000 ft)
Warranty .....	
	1 year

### *i40s-EL Current Clamp Specifications*

Measuring range .....	40mA to 4A ac / 0.4 to 40A ac
Crest factor .....	≤ 3
Nondestructive current.....	200 A (50/60Hz)
Intrinsic Error at reference condition <sup>[1]</sup> .....	±0.5% of reading
Accuracy 1730 + clamp.....	±(0.7 % of reading + 0.02% of range)
Phase shift	
<40 mA.....	unspecified
40 mA to 400 mA .....	< ± 1.5°
400 mA to 40 A .....	< ± 1°
Temperature Coefficient over operating temperature range .....	
	0.015 % of reading / °C 0.027 % of reading / °F
Influence of adjacent conductor .....	
	≤15 mA/A (@ 50/60 Hz)
Influence of conductor position in jaw opening .....	
	±0.5 % of reading (@ 50/60 Hz)
Bandwidth .....	
	10 Hz to 2.5 kHz
Working Voltage.....	
	600 V CATIII, 300 V CATIV
[1] Reference Condition:	
	• Environmental: 23 °C ±5 °C, no external electrical/magnetic field, RH 65 %
	• Primary conductor in center position
Size (H x W x L) .....	
	110 mm x 50 mm x 26 mm (4.33 in x 1.97 in x 1.02 in)
Maximum conductor size .....	
	15 mm (0.59 in)
Output cable length.....	
	2 m (6.6 ft)
Weight.....	
	190 g (6.70 oz)
Material .....	
	Case ABS and PC Output cable: TPR/PVC
Temperature operating .....	
	-10 °C to +55 °C (-14 °F to 131 °F)
Temperature, non-operating .....	
	-20 °C to +70 °C (-40 °F to 158 °F)



