

NOTES:

1. ROHS COMPLIANT
2. HEADER: THERMOSET PLASTIC MATERIAL WITH FLAMMABILITY RATING UL 94V-0 OR BETTER.
3. STORAGE TEMPERATURE: -20°C TO +125°C
4. COMPLIANCE TO J-STD:
 - A. J-STD-002: SOLDERABILITY AT 245°C REFLOW PROFILE
 - B. J-STD-020: LEVEL 1, NO MOISTURE SENSITIVE
 - C. J-STD-075: R7, 245°C MAXIMUM THROUGH REFLOW SOLDER
5. TO ORDER TAPE & REEL PACKAGING ADD A "T" SUFFIX TO THE PART NUMBER(i.e H1197NL BECOMES H1197NLT).

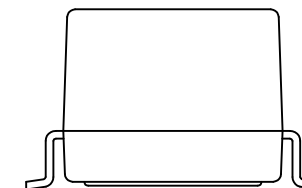
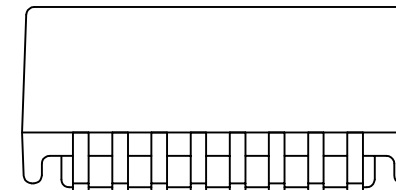
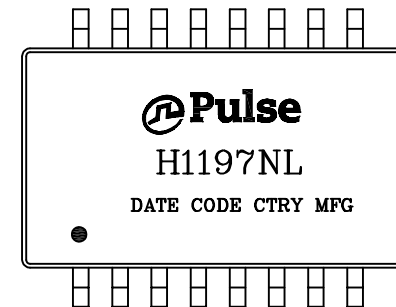

FINAL OUTLINE

© Copyright, 2015. Pulse Electronics Corp. All rights reserved. Pulse confidential & proprietary. (07/31/15)

PRODUCT DESCRIPTION	TLA DRAWING	PS DRAWING	SHEET	PART NO.	DATASHEET REV.
XFRM,SIN,100D,1:1,SMT	H1197NL-13	PS-2005.001-F	1 OF 3	H1197NL	A

ELECTRICAL CHARACTERISTICS AT +25°C UNLESS OTHER SPECIFIED
MEETS IEEE 802.3 SPECIFICATION

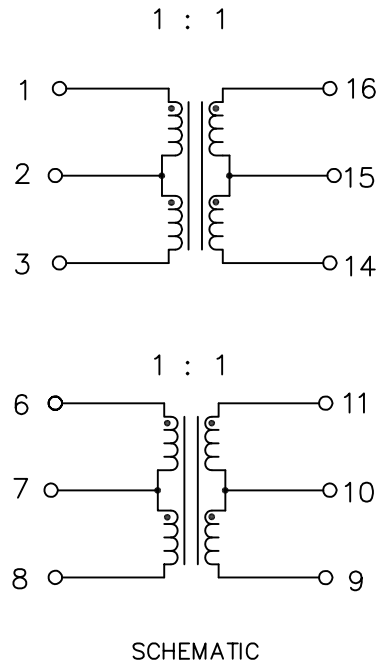

PARAMETER	SPECIFICATIONS	
OPERATING TEMP	0°C – 70 °C	
URNS RATIO	1 : 1 ±2%	
POLARITY	PER SCHEMATIC	
INSERTION LOSS	100 KHz	1–125 MHz
	–.3 dB MAX	–.3–.002*f ^{1.31}
RETURN LOSS (Z OUT = 100 OHM ±15%)	.1–40 MHz	40–100 MHz
	–18 dB MIN	–12+20*LOG ₁₀ (f/80 MHz) dB MIN
INDUCTANCE (OCL) (MEDIA SIDE, 0°C–70°C)	1200 uH MINIMUM (MEASURED AT 100 KHz, 100 mVRMS) AND WITH 8 mA DC BIAS)	
URNS RATIO	(1–3) : (16–14) = 1:1 ±1% (6–8) : (11–9) = 1:1 ±1%	
DC RESISTANCE	0.8 OHMS MAX	
LEAKAGE INDUCTANCE	0.35 uH MAX	
DC RESISTANCE BALANCE	±.065 OHMS	
INPUT – OUTPUT ISOLATION	1500 VRMS MIN @ 60 SECONDS	

NOTE: f IS FREQUENCY IN MHz.

© Copyright, 2015. Pulse Electronics Corp. All rights reserved. Pulse confidential & proprietary. (07/31/15)

PRODUCT DESCRIPTION	TLA DRAWING	PS DRAWING	SHEET	PART NO.	DATASHEET REV.
XFRM,SIN,100D,1:1,SMT	H1197NL–13	PS–2005.001–F	2 OF 3	H1197NL	A

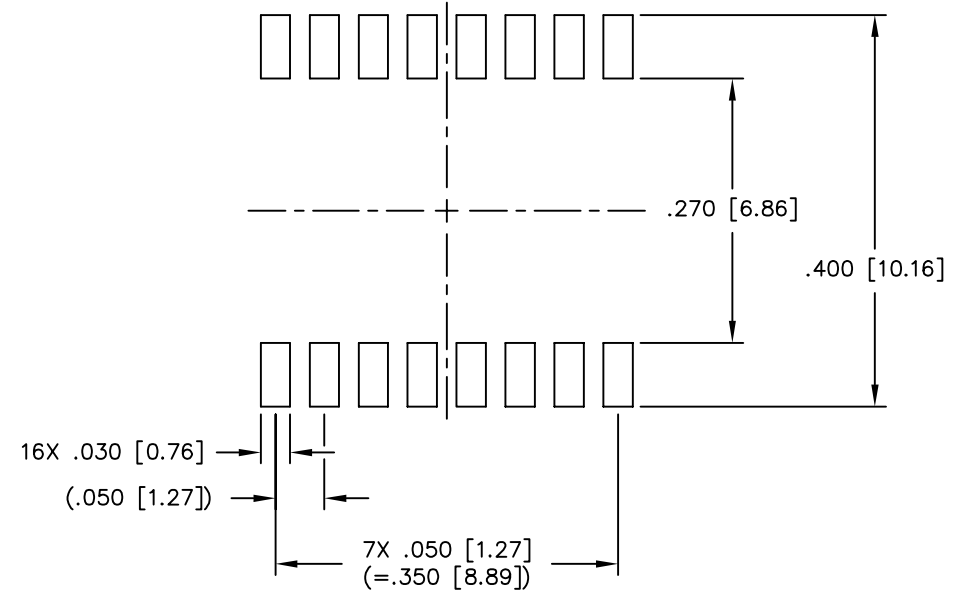
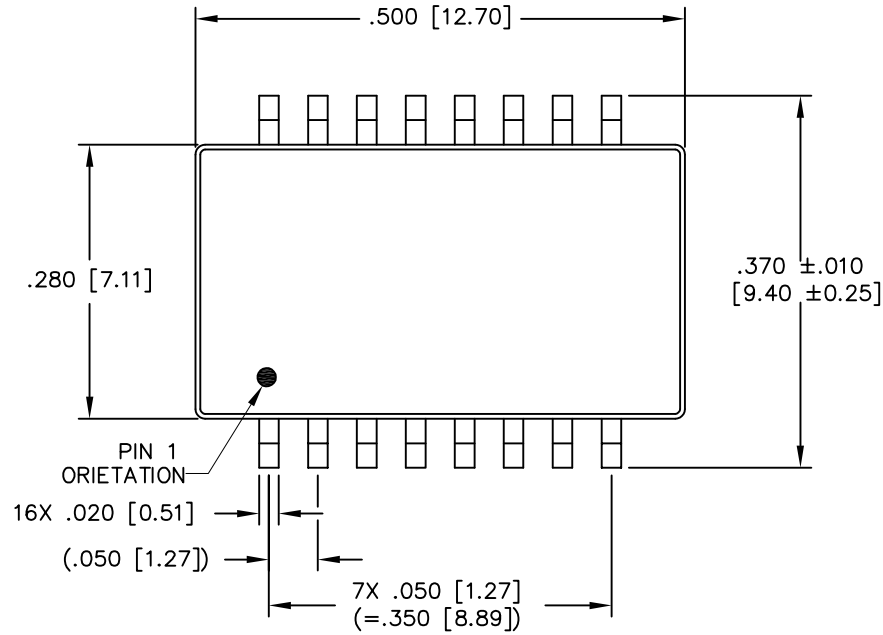

SUGGESTED LAND PATTERN

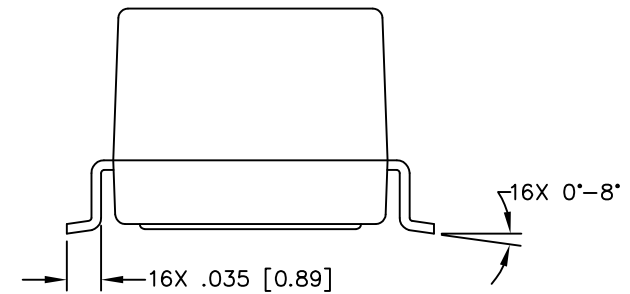
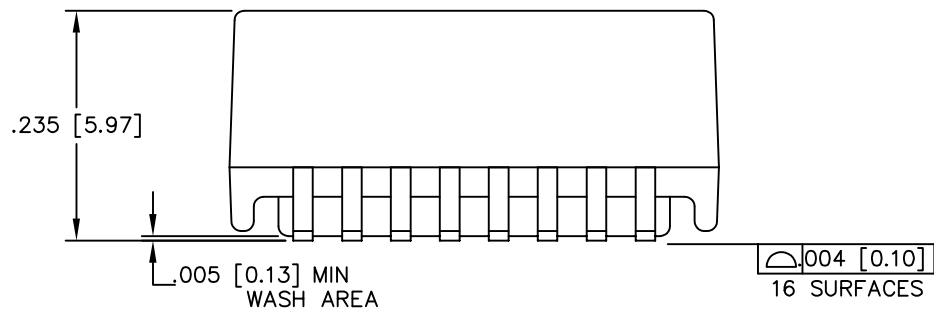

DIMENSIONS ARE IN INCHES [MILLIMETERS] WITH THE FOLLOWING TOLERANCES: [MILLIMETERS] ARE FOR REFERENCE ONLY.
.XX= ±.01 [±0.25]
.XXX= ±.005 [±0.13]

© Copyright, 2015. Pulse Electronics Corp. All rights reserved. Pulse confidential & proprietary. (07/31/15)

PRODUCT DESCRIPTION	TLA DRAWING	PS DRAWING	SHEET	PART NO.	DATASHEET REV.
XFRM,SIN,100D,1:1,SMT	H1197NL-13	PS-2005.001-F	3 OF 3	H1197NL	A