



# Inductors for Decoupling Circuits

Wound ferrite

**ADL-VT series (for automobiles)**

# ADL3225VT<sub>type</sub>

---

ADL3225VT 3225 [1210 inch]\*

\* Dimensions code JIS[EIA]

## **Caution**

This catalog includes the products which are in preparation for mass production.

---

# INDUCTORS



Products in this page are in preparation for mass production.

Part No.	Status
ADL3225VT-100M-TL000	Preliminary

## Reminders for using these products

Before using these products, be sure to request the delivery specifications.

### Safety reminders

Please pay sufficient attention to the warnings for safe designing when using this products.

#### Reminders

- The storage period is less than 6 months. Be sure to follow the storage conditions (temperature: 5 to 40°C, humidity: 10 to 75% RH or less).  
If the storage period elapses, the soldering of the terminal electrodes may deteriorate.
- Do not use or store in locations where there are conditions such as gas corrosion (salt, acid, alkali, etc.).
- Before soldering, be sure to preheat components.  
The preheating temperature should be set so that the temperature difference between the solder temperature and chip temperature does not exceed 150°C.
- Soldering corrections after mounting should be within the range of the conditions determined in the specifications.  
If overheated, a short circuit, performance deterioration, or lifespan shortening may occur.
- When embedding a printed circuit board where a chip is mounted to a set, be sure that residual stress is not given to the chip due to the overall distortion of the printed circuit board and partial distortion such as at screw tightening portions.
- Self heating (temperature increase) occurs when the power is turned ON, so the tolerance should be sufficient for the set thermal design.
- Carefully lay out the coil for the circuit board design of the non-magnetic shield type.  
A malfunction may occur due to magnetic interference.
- Use a wrist band to discharge static electricity in your body through the grounding wire.
- Do not expose the products to magnets or magnetic fields.
- Do not use for a purpose outside of the contents regulated in the delivery specifications.
- The products listed on this catalog are intended for use in general electronic equipment (AV equipment, telecommunications equipment, home appliances, amusement equipment, computer equipment, personal equipment, office equipment, measurement equipment, industrial robots) under a normal operation and use condition.  
The products are not designed or warranted to meet the requirements of the applications listed below, whose performance and/or quality require a more stringent level of safety or reliability, or whose failure, malfunction or trouble could cause serious damage to society, person or property.  
If you intend to use the products in the applications listed below or if you have special requirements exceeding the range or conditions set forth in the each catalog, please contact us.

- (1) Aerospace/aviation equipment
- (2) Transportation equipment (electric trains, ships, etc.)
- (3) Medical equipment
- (4) Power-generation control equipment
- (5) Atomic energy-related equipment
- (6) Seabed equipment
- (7) Transportation control equipment

- (8) Public information-processing equipment
- (9) Military equipment
- (10) Electric heating apparatus, burning equipment
- (11) Disaster prevention/crime prevention equipment
- (12) Safety equipment
- (13) Other applications that are not considered general-purpose applications

When designing your equipment even for general-purpose applications, you are kindly requested to take into consideration securing protection circuit/device or providing backup circuits in your equipment.

# Inductors for Decoupling Circuits

Wound ferrite

Product compatible with RoHS directive  
Halogen-free  
Compatible with lead-free solders  
AEC-Q200

## Overview of ADL3225VT type

### FEATURES

- Small size and thin form factor (mounting area 3.2 x 2.5 mm, height 2.5mm max.)
- Achieving broadband impedance characteristics and good DC superimposition characteristics as the result of an original coiled wiring design and original structure
- Ensuring consistent high quality and reliability as the result of a completely automated manufacturing process

### APPLICATION

- Inductor for use with separate signal and power lines in in-vehicle PoC (Power Over Coax)

### PART NUMBER CONSTRUCTION

ADL	3225V	T	-	4R7	M	-	TL	000
Series name	LxWxH dimensions (mm) 3.2x2.5x2.3	Metal terminals		Inductance (μH) 4R7   4.7	Inductance Tolerance M   ±20%		Packaging style TL   ø330mm reel	Internal code 000

### OPERATING TEMPERATURE RANGE, PACKAGE QUANTITY, PRODUCT WEIGHT

Type	Temperature ranges		Package quantity (pieces/reel)	Individual weight (g)
	Operating temperature* (°C)	Storage temperature (°C)		
ADL3225VT	-40 to +150	-40 to +150	6000	0.063

\* The operating temperature range includes self-temperature rise.

- RoHS Directive Compliant Product: See the following for more details.<https://product.tdk.com/info/en/environment/rohs/index.html>
- Halogen-free: Indicates that Cl content is less than 900ppm, Br content is less than 900ppm, and that the total Cl and Br content is less than 1500ppm.

 Please be sure to request delivery specifications that provide further details on the features and specifications of the products for proper and safe use.  
Please note that the contents may change without any prior notice due to reasons such as upgrading.

# ADL3225VT type

## RECOMMENDED REFLOW PROFILE

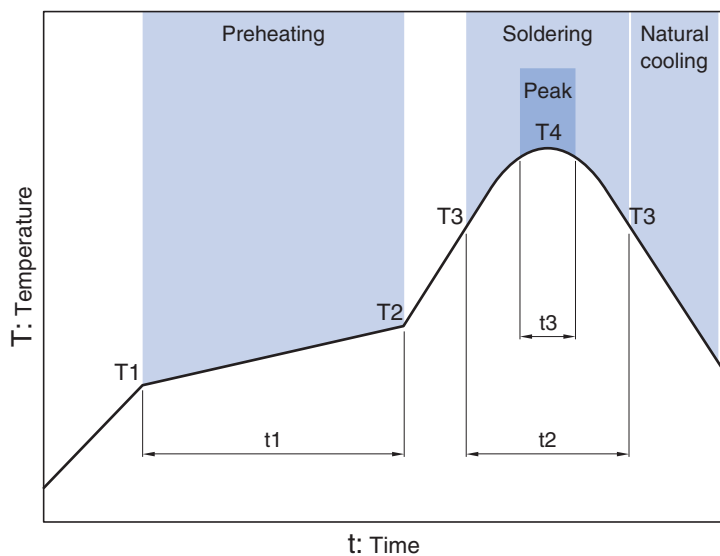

Preheating			Soldering		Peak	
Temp.		Time	Temp.	Time	Temp.	Time
T1	T2	t1	T3	t2	T4	t3
150°C	180°C	90 to 120s	230°C	40s	245°C	5s max.

# ADL3225VT type

## SHAPE & DIMENSIONS

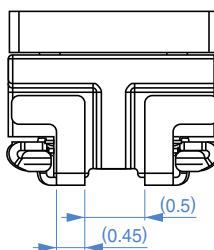
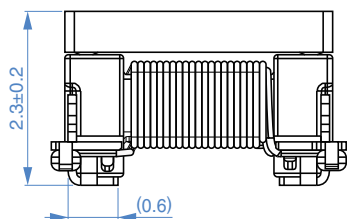
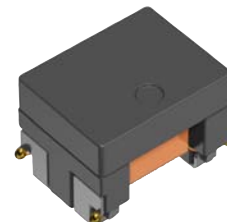
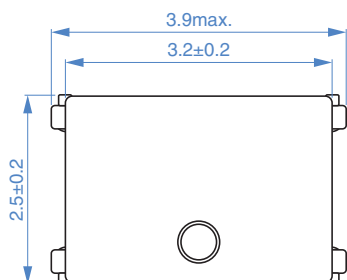

Dimensions in mm

## RECOMMENDED LAND PATTERN

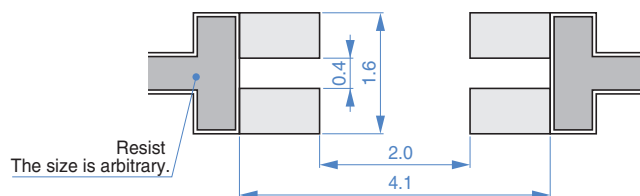

Dimensions in mm

# ADL3225VT type

## ELECTRICAL CHARACTERISTICS

### CHARACTERISTICS SPECIFICATION TABLES

L ( $\mu$ H)	Tolerance	L measuring frequency (kHz)	DC resistance ( $\Omega$ )max.	Rated current*		Part No.
				Isat (mA)typ.	Itemp (mA)typ.	
4.7	$\pm 20\%$	100	0.1	720	1500	ADL3225VT-4R7M-TL000
10	$\pm 20\%$	100	0.15	450	1300	ADL3225VT-100M-TL000

\* Rated current: smaller value of either Isat or Itemp.

Isat: when based on the inductance change rate (30% below the initial L value)

Itemp: When based on the temperature increase (temperature increase of 40°C by self heating)

#### Measurement equipment

Measurement item	Product No.	Manufacturer
Inductance	4294A	Keysight Technologies
DC resistance	4338A	Keysight Technologies

\* Equivalent measurement equipment may be used.

# ADL3225VT type

## ■ ELECTRICAL CHARACTERISTICS

### □ IMPEDANCE FREQUENCY CHARACTERISTICS GRAPH

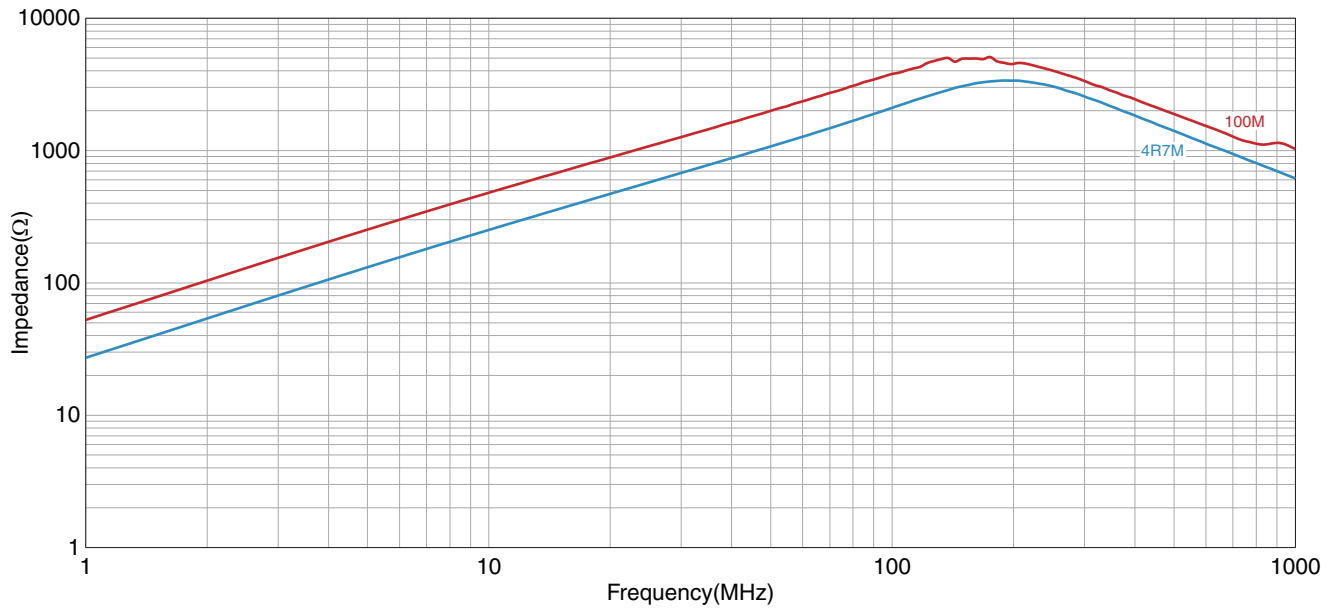



# ADL3225VT type

## ELECTRICAL CHARACTERISTICS

### INDUCTANCE VS. DC BIAS CHARACTERISTICS GRAPH

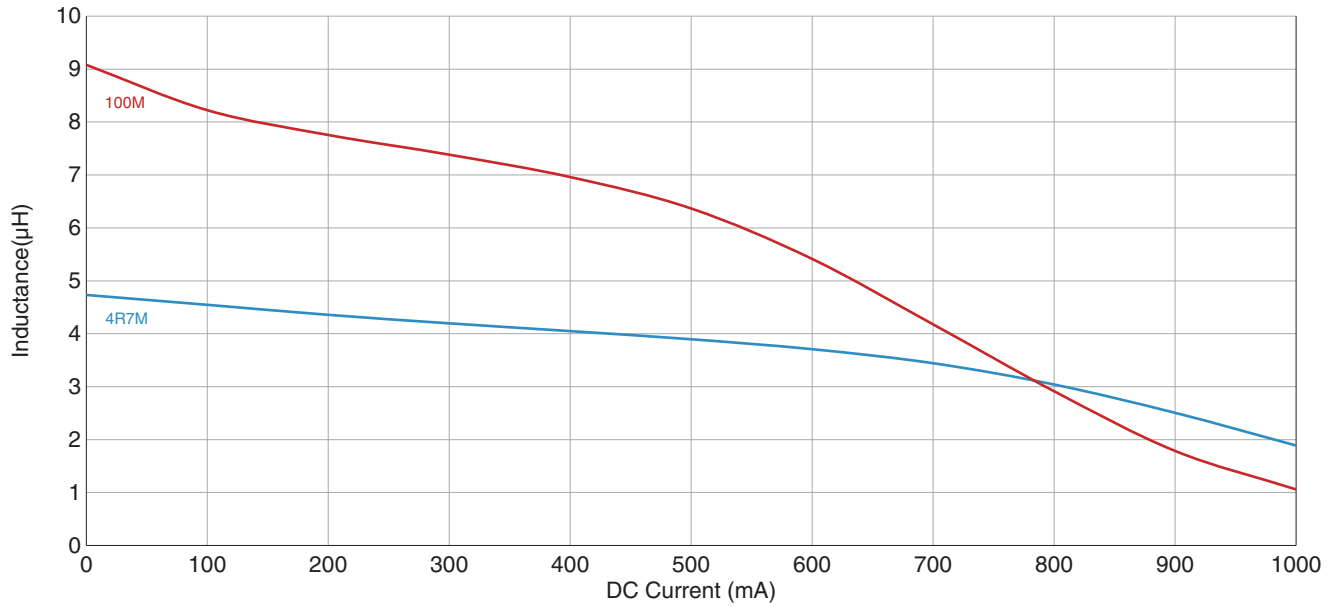

# ADL3225VT type

## PACKAGING STYLES

### REEL DIMENSIONS

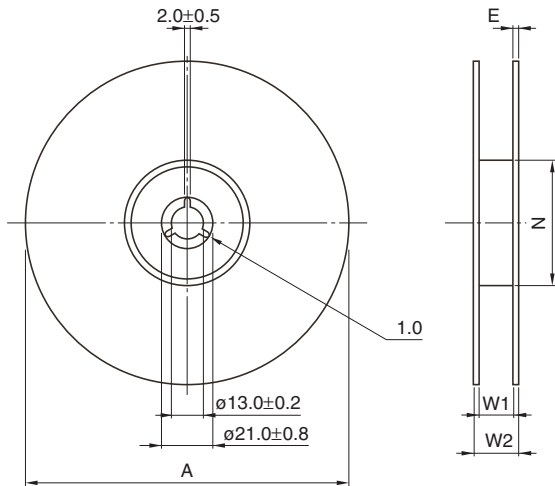

Type	A	W1	W2	N	E
ADL3225VT	ø330±2	13.5±0.5	17.5±1	100±1	2 typ.

Dimensions in mm

### TAPE DIMENSIONS

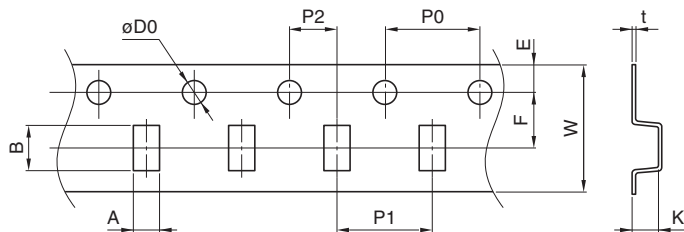

Dimensions in mm

Type	A	B	øD0	E	F	P0	P1	P2	W	K	t
ADL3225VT	2.85±0.1	4.2±0.1	1.5+0.1/-0	1.75±0.1	5.5±0.05	4±0.1	4±0.1	2±0.05	12+0.3/-0	2.7±0.1	0.35±0.1