

Printed-circuit board connector - DFMC 1,5/ 9-ST-3,5 - 1790179

Please be informed that the data shown in this PDF Document is generated from our Online Catalog. Please find the complete data in the user's documentation. Our General Terms of Use for Downloads are valid (<http://phoenixcontact.com/download>)

Plug, nominal current: 8 A, rated voltage (III/2): 160 V, number of positions: 9 with 18 contacts, pitch: 3.5 mm, connection method: spring-cage connection, color: green, contact surface: tin

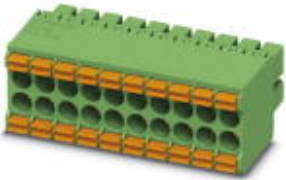

The figure shows a 10-pos. version with 20 contacts

Why buy this product

- Time saving push-in connection, tools not required
- Defined contact force ensures that contact remains stable over the long term
- Intuitive use through colour coded actuation lever
- Optimized for tight installation situations: operation and conductor connection from one direction

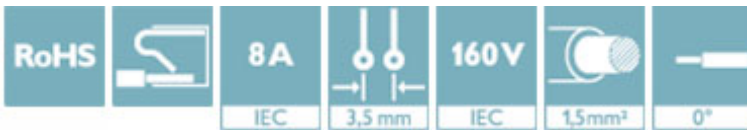

Key Commercial Data

Packing unit	50 STK
GTIN	 4 046356 594325
GTIN	4046356594325

Technical data

Dimensions

Length [l]	23.35 mm
Width [w]	32.3 mm
Height [h]	13.25 mm
Pitch	3.5 mm
Dimension a	28 mm

General

Range of articles	DFMC 1,5/...-ST
Type of contact	Female connector
Number of positions	9
Connection method	Push-in spring connection
Insulating material group	I

Printed-circuit board connector - DFMC 1,5/ 9-ST-3,5 - 1790179

Technical data

General

Rated surge voltage (III/3)	2.5 kV
Rated surge voltage (III/2)	2.5 kV
Rated surge voltage (II/2)	2.5 kV
Rated voltage (III/3)	160 V
Rated voltage (III/2)	160 V
Rated voltage (II/2)	250 V
Connection in acc. with standard	EN-VDE
Nominal current I_N	8 A
Nominal cross section	1.5 mm ²
Maximum load current	8 A
Insulating material	PA
Flammability rating according to UL 94	V0
Internal cylindrical gage	A1
Stripping length	10 mm

Connection data

Conductor cross section solid min.	0.2 mm ²
Conductor cross section solid max.	1.5 mm ²
Conductor cross section flexible min.	0.2 mm ²
Conductor cross section flexible max.	1.5 mm ²
Conductor cross section flexible, with ferrule without plastic sleeve min.	0.25 mm ²
Conductor cross section flexible, with ferrule without plastic sleeve max.	1.5 mm ²
Conductor cross section flexible, with ferrule with plastic sleeve min.	0.25 mm ²
Conductor cross section flexible, with ferrule with plastic sleeve max.	0.75 mm ²
Conductor cross section AWG min.	24
Conductor cross section AWG max.	16
Minimum AWG according to UL/CUL	16
Maximum AWG according to UL/CUL	24

Specifications for ferrules

Recommended crimping pliers	1212034 CRIMPFOX 6
Ferrules without insulating collar, according to DIN 46228-1	Cross section: 0.25 mm ² ; Length: 5 mm ... 7 mm
	Cross section: 0.5 mm ² ; Length: 8 mm ... 10 mm
	Cross section: 0.75 mm ² ; Length: 8 mm ... 10 mm
	Cross section: 1 mm ² ; Length: 8 mm ... 10 mm
	Cross section: 1.5 mm ² ; Length: 10 mm

Standards and Regulations

Connection in acc. with standard	EN-VDE
	CUL
Flammability rating according to UL 94	V0

Environmental Product Compliance

Printed-circuit board connector - DFMC 1,5/ 9-ST-3,5 - 1790179

Technical data

Environmental Product Compliance

China RoHS	Environmentally friendly use period: unlimited = EFUP-e
	No hazardous substances above threshold values

Drawings

Diagram

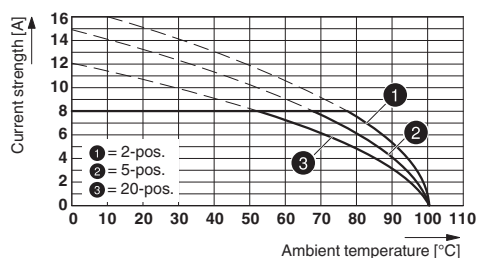

Dimensional drawing

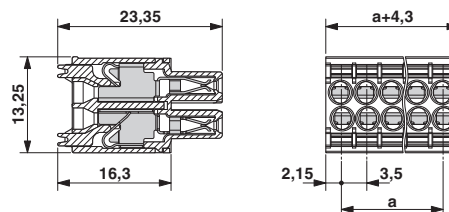

Typ: DFMC 1,5/...-ST-3,5 with DMCV 1,5/...-G1-3,5 P20 THR

Schematic diagram

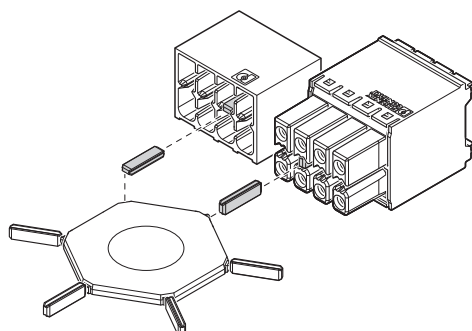

Diagram

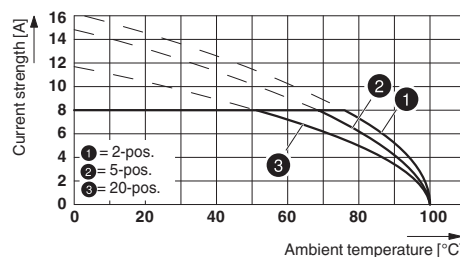

Typ: DFMC 1,5/...-ST-3,5 with DMC 1,5/...-G1-3,5 P20 THR

Use of the CP-DMC... coding profile

Approvals

Approvals

Approvals

VDE Gutachten mit Fertigungsüberwachung / IEC60335 CB Scheme / EAC / cULus Recognized

Ex Approvals

Approval details

Printed-circuit board connector - DFMC 1,5/ 9-ST-3,5 - 1790179

Approvals

VDE Gutachten mit Fertigungsüberwachung		http://www2.vde.com/de/Institut/Online-Service/ VDE-gepruefteProdukte/Seiten/Online-Suche.aspx	40038423
Nominal voltage UN		160 V	
Nominal current IN		8 A	
mm ² /AWG/kcmil		0.2-1.5	

IECEE CB Scheme		http://www.iecee.org/	DE1-60359_B1_B2
Nominal voltage UN		160 V	
Nominal current IN		8 A	

EAC		B.01742
-----	---	---------

cULus Recognized		http://database.ul.com/cgi-bin/XYV/template/LISEXT/1FRAME/index.htm	E60425-19920306
	D	B	C
Nominal voltage UN	300 V	300 V	50 V
Nominal current IN	8 A	8 A	8 A
mm ² /AWG/kcmil	24-16	24-16	24-16

Phoenix Contact 2018 © - all rights reserved
<http://www.phoenixcontact.com>

PHOENIX CONTACT GmbH & Co. KG
 Flachsmarktstr. 8
 32825 Blomberg
 Germany
 Tel. +49 5235 300
 Fax +49 5235 3 41200
<http://www.phoenixcontact.com>