

# PocketProjector

Quick Start Guide

3M™ MPro**150**





## Parts

- 1 Directional Pad
- 2 OK Button
- 3 Back Button
- 4 Power Button
- 5 Micro SD Card Slot
- 6 Status Indicator
- 7 Focus Wheel
- 8 Lens
- 9 Speaker
- 10 DC Power Input
- 11 Micro-USB Port
- 12 Headphone Jack
- 13 VGA-AV Input
- 14 Battery Cover
- 15 Tripod Socket
- 16 Flip Stand

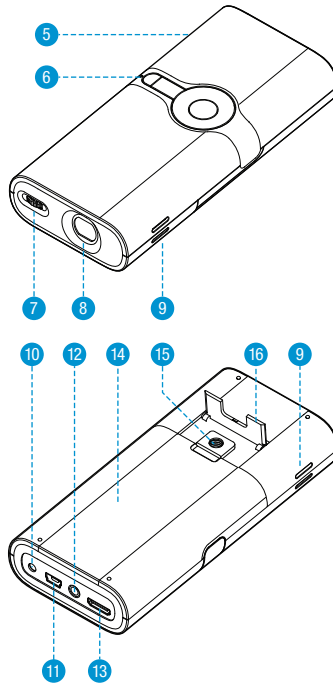
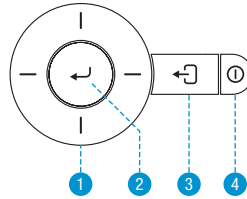

## Read Safety Guide First

**Lire d'abord le manuel de sécurité • Zuerst die Sicherheitshinweise lesen**  
**Lea la Guía de Seguridad primero • Prima leggere la guida per la sicurezza**  
**Lees eerst de veiligheids gids • Läs säkerhetsguiden först**  
 首先要阅读安全指南 • 先閱讀工安指南 • 安全ガイドを最初に読んでください。





3M™ Pocket Projector MPro150

## Install the Battery

Installation de la batterie • Akku installieren •  
 Instalar la batería • Installare la batteria •  
 De accu installeren • Installera batteriet •  
 安装电池 • 安裝電池 • 電池の取り付け

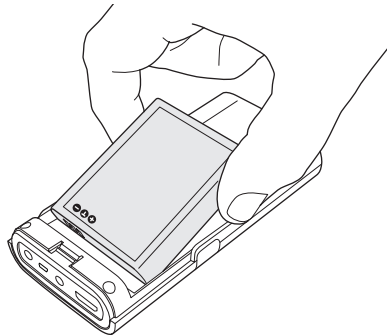
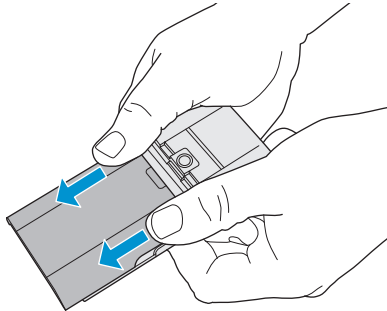

## Assemble the Power Adapter

Assemblage du bloc secteur • Zusammenbau des  
 netzteils • Ensamble el adaptador de alimentación  
 • Montare l'alimentatore • Montage van de  
 stroomadapter • Sätt ihop strömadaptern •  
 组装该电源适配器 • 裝配電源轉換器 •  
 の組立て ACアダプタ

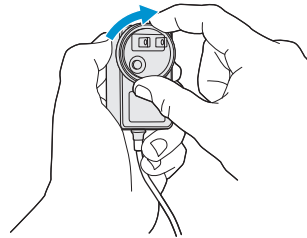
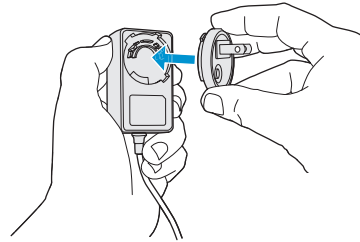



## Charge the Battery

Mise en charge de la batterie • Akku laden • Cargar la batería • Caricare la batteria • Accu opladen • Ladda batteriet • 给電池充电 • 給電池充電 • 電池の充電

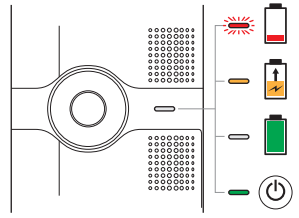
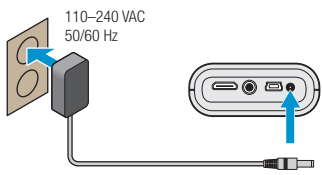

## Turn the Projector On and Off

Mise en marche et arrêt du projecteur • Stellen Sie den Projektor an und ab • Dé vuelta al proyector por intervalos • Giri il proiettore in funzione e a riposo • Draai de aan en uit Projector • Vänd projektorn på och stänga av • 打开和关上放映机 • 打開和關上放映機 • プロジェクターを不規則に回しなさい

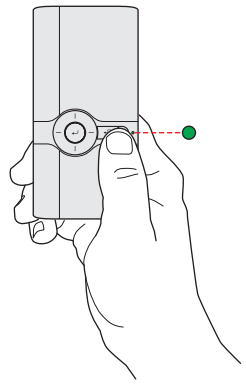



## Projection Mode

Mode de projection • Projektionsmodus • Modo proyección •  
Modalità proiezione • Projectiemodus • Visningsläge •  
投影模式 • 投影模式 • 投影モード

## Connect a Video Source

Connexion d'une source vidéo • Eine Videoquelle anschließen • Conecte una fuente de video • Collegare a una sorgente video • Een videobron aansluiten • Anslut en video • 连接视频源 • 连接视频源 • ビデオソースの接続

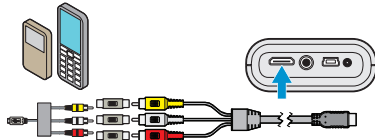
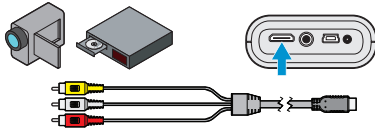

*Note: Some devices require a special cable to connect to the projector.*

*Remarque: Certains dispositifs nécessitent un câble spécial pour effectuer le branchement au projecteur.*

*Hinweis: Einige Geräte erfordern ein besonderes Kabel für den Anschluss an den Projektor.*

*Note: Algunos dispositivos requieren un especialCable para conectar el proyector.*

*Nota: Alcuni dispositivi richiedono un cavo speciale per il collegamento al proiettore.*

*Opmerking: Sommige apparaten hebben een speciale kabel nodig om te kunnen worden aangesloten op de projector.*

*OBS: Vissa enheter kräver speciella kablar för anslutning till projektorn.*

**注意：**一些设备需要一条特殊的电缆，以连接到投影机上。

**注意：**一些設備需要一條特別的電纜，以连接到該投影机。

**メモ：**デバイスの中には、プロジェクターに接続する特別なケーブルを必要とするものがあります。

## Connect a Computer

Connexion d'un ordinateur • Einen Computer anschließen • Conectar un ordenador • Collegare un computer • Aansluiten op een computer • Anslut en dator • 连接电脑 • 连接电脑 • コンピュータの接続

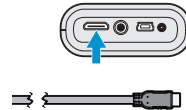

Description	Resolution	Refresh Rate
VGA	640 x 480	60 Hz
SVGA	800 x 600	60 Hz
XGA	1024 x 768	60 Hz
WXGA	1280 x 768	60 Hz





## Projection Mode

Mode de projection • Projektionsmodus • Modo proyección •  
Modalità proiezione • Projectiemodus • Visningsläge •  
投影模式 • 投影模式 • 投影モード

## Adjust the Volume

Réglage du volume • Einstellen der Lautstärke •  
Ajustar el volumen • Regolare il volume •  
Het volume aanpassen • Justera volymen •  
调节音量 • 調整音量 • 音量の調整

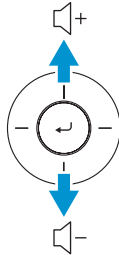

## Check the Battery Level

Vérification du niveau de la batterie • Prüfen des  
Akku-Ladezustands • Comprobar el nivel de batería  
• Controllare il livello della batteria • Het accuniveau  
controleren • Kontrollera batterinivån •  
检查电池水平 • 檢查電池水平 •  
電池レベルのチェック

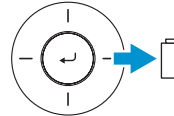

## Change the Brightness

Modification de la luminosité • Ändern der Helligkeit  
• Cambiar el brillo • Modificare la luminosità •  
De helderheid wijzigen • Ändra ljusstyrka •  
改变亮度 • 改變亮度 • 輝度の変更

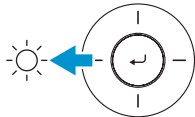



## Media Player Mode

Mode lecture de média • Media Player-Modus • Modo de reproducción de medios •  
 Modalità riproduttore multimediale • Media playermodus • Mediaspelning •  
 媒体播放机模式 • 媒體播放器模式 • メディアプレーヤーのモード

## Install Optional Micro SD Card

Installation d'une carte micro SD en option •  
 Einlegen der optionalen Mikro SC-Karte • Instalar la tarjeta Micro SD opcional • Installare la scheda opzionale Micro SD • De optionele Micro SD-kaart installeren • Installera (valfritt) Micro SD-kort •  
 安装可选的Micro SD卡 • 安裝可選的Micro SD卡 • オプションのマイクロ SD カードの取り付け

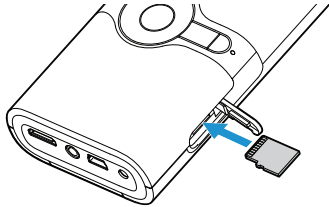

To insert or remove the Micro SD card, press it in until it clicks.  
 Pour introduire et retirer la carte micro SD, appuyer sur celle-ci jusqu'à percevoir un dé clic.  
 Zum Einschieben oder Entfernen der Mikro SD-Karte drücken Sie diese ein, bis ein Klicken hörbar ist.  
 Para insertar o quitar la tarjeta Micro SD, presiónela hasta que haga clic.  
 Per inserire o rimuovere la scheda Micro SD, spingerla fino ad avvertire uno scatto.  
 Druk op de Micro SD-kaart tot deze klikt om de kaart te plaatsen of te verwijderen.  
 För att stoppa i eller ta ut Micro SD-kortet, tryck det inåt tills ett klick hörs.  
 要插入或取出Micro SD卡，將其按入至听到咔嚓声为止。  
 要插入或者取出Micro SD卡，將其按入，直至聽到啵啵聲為止。  
 マイクロ SD カードを取り付けまたは取り外しするには、カチッと音がするまで押し込みます。

## Transfer Files

Transfert de fichiers • Übertragung von Dateien •  
 Transferir archivos • Trasferire file • Bestanden overzetten • Överföringsfiler • 传送文件 •  
 傳送文件 • ファイルの転送

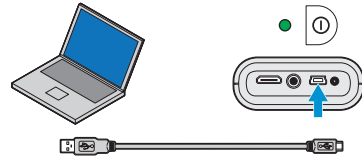



## Replacement Parts & Accessories

Description	3M Part Number
Power Adapter with US, EU, UK, AUS plugs	78-6972-0003-4
Lithium-Ion Polymer Battery	78-6972-0004-2
AV Video Cable	78-6972-0006-7
VGA Cable	78-6972-0007-5
Car Charger	78-6972-0002-6
Component AV cable	78-6972-0005-9
3M Adapter Cable for Apple®	78-6972-0001-8
Portable Presentation Binder	78-6969-9997-4

3M is a trademark of 3M Company.

# 3M

### Projection Systems 3M Austin Center

6801 River Place Blvd.  
Austin, TX 78726-9000  
866-631-1656  
[www.3M.com/meetings](http://www.3M.com/meetings)  
[meetings@mmm.com](mailto:meetings@mmm.com)

Please Recycle. Printed in USA.  
© 3M 2009. All Rights Reserved.  
78-6971-1517-4

