

**MCP3020 MCP3021
MCP3022**

PACKAGE DIMENSIONS

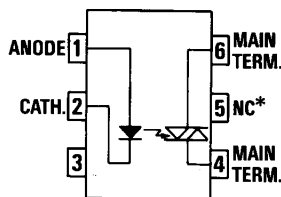
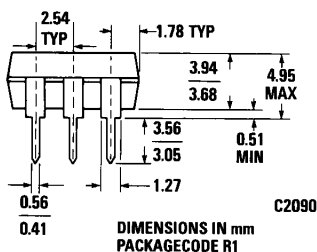
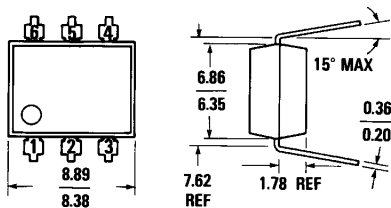

C2081

Equivalent Circuit

DESCRIPTION

The MCP3020, MCP3021 and MCP3022 are optically isolated triac driver devices. These devices contain a GaAs infrared emitting diode and a light activated silicon bilateral switch, which functions like a triac. This is designed for interfacing between electronic controls and power triacs to control resistive and inductive loads for 240 VAC operations.

FEATURES

- Minimum commutating dv/dt is specified at 0.1 V/ μ sec
- Excellent I_T stability—IR emitting diode has low degradation
- Pin for pin replacement for the MOC3020, MOC3021 and MOC3022
- High isolation voltage—minimum 7500 VAC peak
- Underwriters Laboratory (UL) recognized—File #E50151

APPLICATIONS

- European applications for 240 VAC
- Triac driver
- Industrial controls
- Traffic lights
- Vending machines
- Motor control
- Solid state relay

ABSOLUTE MAXIMUM RATINGS

TOTAL PACKAGE

Storage temperature	−55°C to 150°C
Operating temperature	−40°C to 100°C
Lead temperature (soldering, 10 sec)	260°C
Total package power dissipation @ 25°C (LED plus detector)	330 mW
Derate linearly from 25°C	4.0 mW/°C
Surge isolation voltage	7500 VAC Peak

INPUT DIODE

Forward DC current	60 mA
Reverse voltage	3 V
Peak forward current (1 μ s pulse, 300 pps)	3.0 A
Power dissipation 25°C ambient	100 mW
Derate linearly from 25°C	1.33 mW/°C

OUTPUT DRIVER

Off-state output terminal voltage	400 Volts
On-state RMS current (Full cycle, 50 to 60 Hz)	$T_A=25^\circ\text{C}$ 100 mA $T_A=70^\circ\text{C}$ 50 mA
Peak nonrepetitive surge current (PW=10 ms, DC=10%)	1.2 A
Total power dissipation @ $T_A=25^\circ\text{C}$	300 mW
Derate above 25°C	4.0 mW/°C

ELECTRO-OPTICAL CHARACTERISTICS (25°C Temperature Unless Otherwise Specified)

INDIVIDUAL COMPONENT CHARACTERISTICS						
CHARACTERISTIC	SYMBOL	MIN.	TYP.	MAX.	UNITS	TEST CONDITIONS
INPUT DIODE						
Forward voltage	V_F		1.3	1.50	V	$I_F=30$ mA
Forward voltage temperature coefficient	$\frac{\Delta V_F}{\Delta T_A}$		-1.8		mV/°C	
Reverse breakdown voltage	BV_R	3.0	25		V	$I_R=10$ μ A
Junction capacitance	C_J		50 65		pF	$V_F=0$ V, $f=1$ MHz $V_F=1$ V, $f=1$ MHz
Reverse leakage current	I_R		.35	10	μ A	$V_R=3.0$ V
OUTPUT DETECTOR						
Peak blocking current, either direction	I_{DRM}	—	10	100	nA	$V_{DRM}=400$ V, Note 1
Peak on-state voltage, either direction	V_{TM}	—	2.0	3.0	Volts	$I_{TM}=100$ mA Peak

Note 1. Test voltage must be applied within dv/dt rating.

TRANSFER CHARACTERISTICS							
DC CHARACTERISTICS	SYMBOL	MIN.	TYP.	MAX.	UNITS	TEST CONDITIONS	
LED trigger current (current required to latch output)	MCP3020 MCP3021 MCP3022	I_{FT}	— — —	15 8 5	30 15 10	mA	Main terminal voltage=3.0 V
Holding current		I_H	—	200	—	μ A	Either direction

TRANSFER CHARACTERISTICS						
CHARACTERISTICS	SYMBOL	MIN.	TYP.	MAX.	UNITS	TEST CONDITIONS
dv/dt RATING						
Critical rate of rise of off-state voltage	dv/dt	—	15	—	V/ μ s	Static dv/dt, $T_A=85^\circ$ C (see Fig. 3)
Critical rate of rise of commutating voltage	dv/dt	0.1	0.2	—	V/ μ s	Commutating dv/dt $I_{LOAD}=15$ mA (see Fig. 4)

ISOLATION CHARACTERISTICS						
CHARACTERISTICS	SYMBOL	MIN.	TYP.	MAX.	UNITS	TEST CONDITIONS
Isolation voltage	V_{ISO}	5300			$V_{AC,RMS}$	$I_{IO} \leq 1$ μ A, 1 minute
	V_{ISO}	7500			$V_{AC,PEAK}$	$I_{IO} \leq 1$ μ A, 1 minute
Isolation resistance	R_{ISO}	10^{11}			ohms	$V_{IO}=500$ VDC
Isolation capacitance	C_{ISO}		0.5		pF	$f=1$ MHz

TYPICAL ELECTRICAL CHARACTERISTIC CURVES
(25°C Free Air Temperature Unless Otherwise Specified)

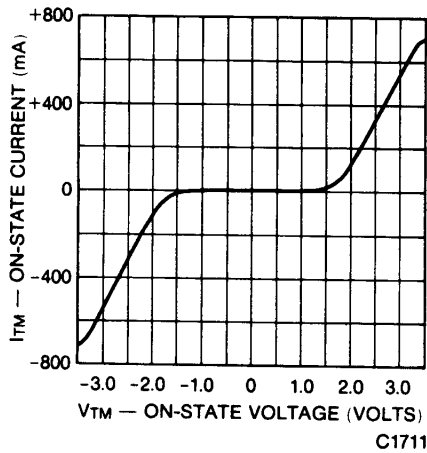

Fig. 1. On-State Characteristics

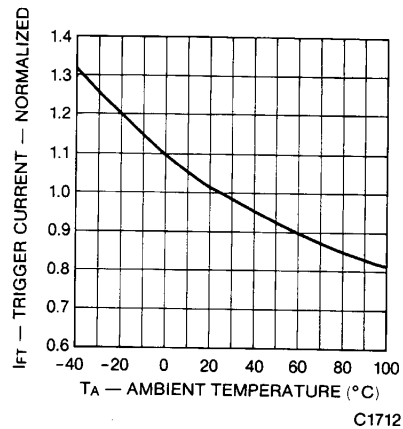
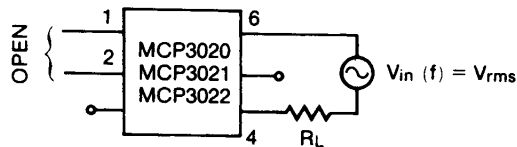

Fig. 2. Trigger Current vs. Temperature

TEST CIRCUITS FOR dV/dt MEASUREMENTS



$$\frac{dV}{dt} = \omega V_{\text{pack}} = 2\pi f \times 1.414 V_{\text{rms}}$$

$$= 8.88 f V_{\text{rms}}$$

Fig. 3. Static dV/dt

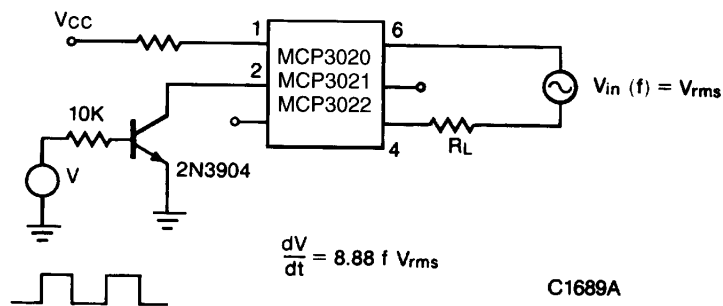

Fig. 4. Commutating dV/dt

DISCLAIMER

FAIRCHILD SEMICONDUCTOR RESERVES THE RIGHT TO MAKE CHANGES WITHOUT FURTHER NOTICE TO ANY PRODUCTS HEREIN TO IMPROVE RELIABILITY, FUNCTION OR DESIGN. FAIRCHILD DOES NOT ASSUME ANY LIABILITY ARISING OUT OF THE APPLICATION OR USE OF ANY PRODUCT OR CIRCUIT DESCRIBED HEREIN; NEITHER DOES IT CONVEY ANY LICENSE UNDER ITS PATENT RIGHTS, NOR THE RIGHTS OF OTHERS.

LIFE SUPPORT POLICY

FAIRCHILD'S PRODUCTS ARE NOT AUTHORIZED FOR USE AS CRITICAL COMPONENTS IN LIFE SUPPORT DEVICES OR SYSTEMS WITHOUT THE EXPRESS WRITTEN APPROVAL OF THE PRESIDENT OF FAIRCHILD SEMICONDUCTOR CORPORATION. As used herein:

1. Life support devices or systems are devices or systems which, (a) are intended for surgical implant into the body, or (b) support or sustain life, and (c) whose failure to perform when properly used in accordance with instructions for use provided in the labeling, can be reasonably expected to result in a significant injury of the user.
2. A critical component in any component of a life support device or system whose failure to perform can be reasonably expected to cause the failure of the life support device or system, or to affect its safety or effectiveness.