

10 9 8 7 6 5 4 3 2 1

F

E

D

C

B

A

F

E

D

C

B

A

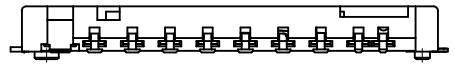
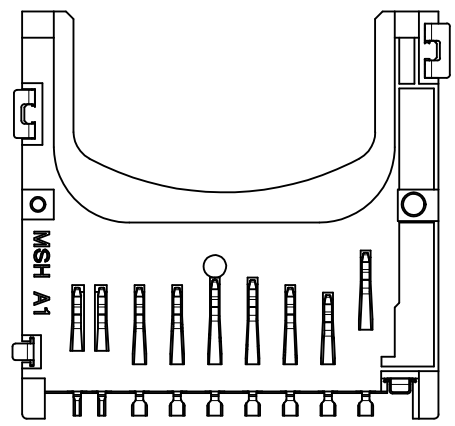
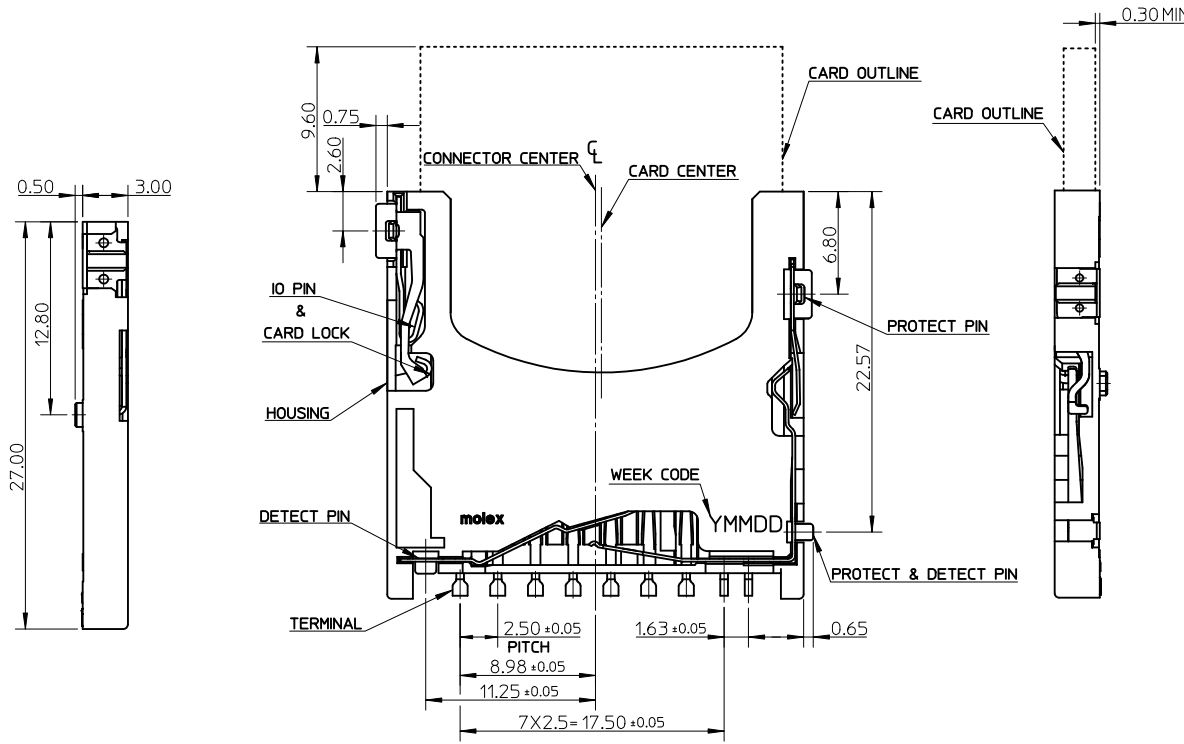
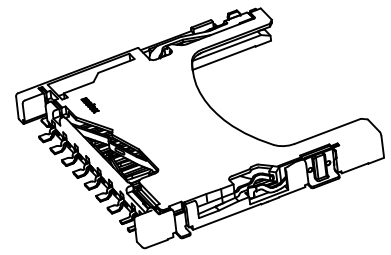

REVISED EC NO: SH2010-0390 DRWN: XQZHANG CHYKD-GLLI APPR: XJSONG 2010/04/07 2010/04/13 2010/05/18	QUALITY SYMBOLS $F_s=0$ $F_C=0$ $F_P=0$	GENERAL TOLERANCES (UNLESS SPECIFIED)		DIMENSION STYLE MM ONLY		SCALE 1:1	DESIGN UNITS METRIC	THIRD ANGLE PROJECTION	
			mm	INCH	DRAWN BY	DATE	TITLE		
		4 PLACES	± ---	± ---	QLZHANG	2004/12/01	SD MEMORY CARD CONNECTOR		
		3 PLACES	± ---	± ---	CHECKED BY	DATE	NORMAL TYPE(NO PUSH FUNCTION, LEAD-FREE)		
			2 PLACES	± 0.25	± ---	HARVEY	2004/12/01	MOLEX INCORPORATED	
			1 PLACE	± 0.25	± ---	APPROVED BY	DATE	MATERIAL NO.	
			ANGULAR ± 2 °			XJSONG	2010/04/14	DOCUMENT NO.	
			DRAFT WHERE APPLICABLE MUST REMAIN WITHIN DIMENSIONS			67781-8001		SD-67781-004	
					SIZE	THIS DRAWING CONTAINS INFORMATION THAT IS PROPRIETARY TO MOLEX INCORPORATED AND SHOULD NOT BE USED WITHOUT WRITTEN PERMISSION			
					A3	SHEET NO.			
						1 OF 3			

9 8 7 6 5 4 3 2 1

OPENING AND CLOSE OF EACH SWITCH			
CARD INSERTION STATUS	WRITE PROTECT SWITCH		CARD DETECT SWITCH
	WRITE PROTECT POSITION	WRITE ENABLE POSITION	
CARD UNINSERTION	OPEN	OPEN	OPEN
CARD INSERTION PROCESS	CLOSE	CLOSE	OPEN
CARD INSERTION	OPEN	CLOSE	CLOSE

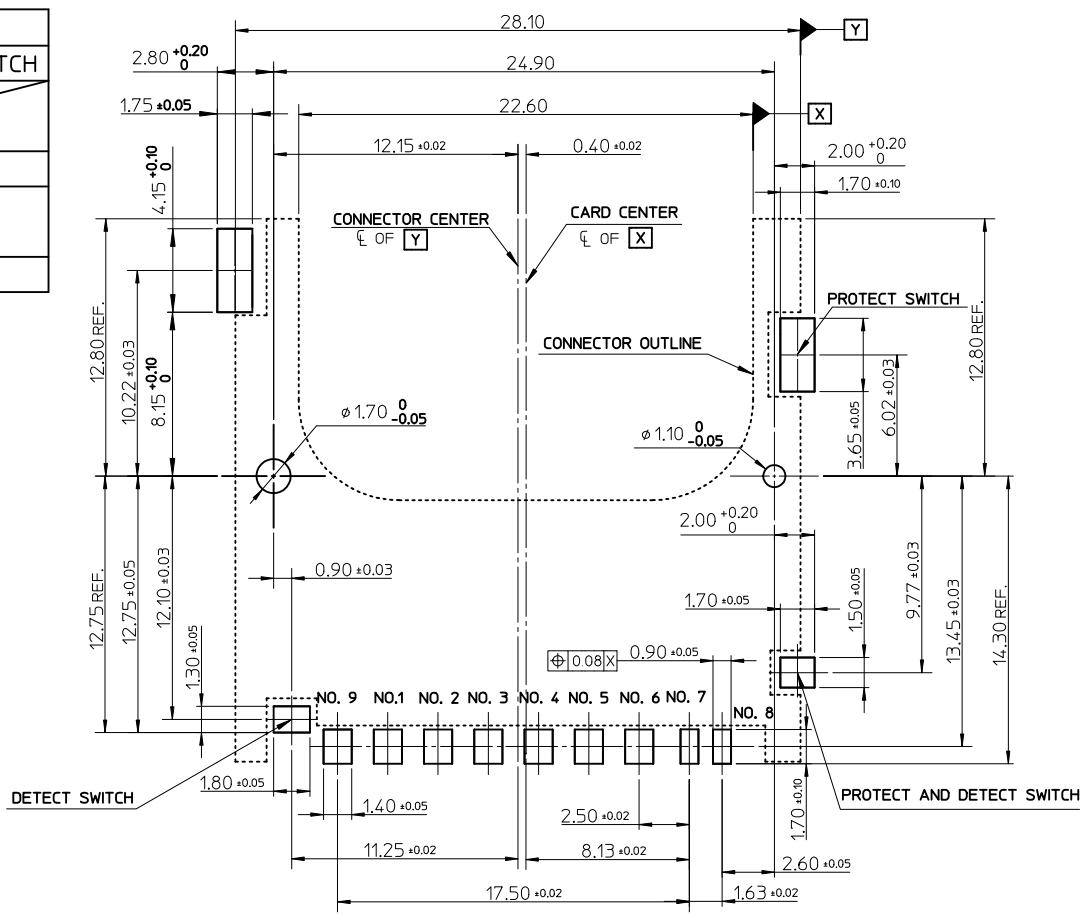

RECOMMENDED P.C.B. PATTERN LAYOUT

NOTES :

- MATERIAL :
  - HOUSING : HEAT RESISTANCE POLYMER, UL94-V0, BLACK.
  - TERMINAL : COPPER ALLOY.
  - PLATING : SELECTIVE GOLD PLATING
  - PROTECT PIN : COPPER ALLOY.
  - PLATING : CONTACT AREA : SELECTIVE GOLD PLATING .
  - PROTECT AND DETECT PIN : COPPER ALLOY.
  - PLATING : CONTACT AREA : SELECTIVE GOLD PLATING.
  - DETECT PIN : COPPER ALLOY.
  - PLATING : CONTACT AREA : SELECTIVE GOLD PLATING.
  - CARD LOCK PIN : STAINLESS STEEL.
- PLATING OF SOLDER AREA FOR ALL TERMINALS AND PINS : PURE TIN PLATING.
- PLATING OF UNDER PLATING FOR ALL TERMINALS AND PINS : NICKEL PLATING.
- TERMINALS AND PINS COPLANARITY TO BE 0.1mm MAXIMUM.
- PRODUCT SPECIFICATION REFER TO PS-67781-001.
- PACKAGE INFORMATION REFER TO PK-67781-001.

SEE SHEET 1 EC NO: SH2010-0390 DRWN:XOZHANG CHKD:GLLI APPR:XJ.SONG	REV DESCRIPTION	QUALITY SYMBOLS	GENERAL TOLERANCES (UNLESS SPECIFIED)	DIMENSION STYLE	SCALE	DESIGN UNITS	THIRD ANGLE PROJECTION	
		$\nabla = 0$	mm INCH	MM ONLY	1:1	METRIC		
		$\nabla = 0$	4 PLACES ± --- ± ---	DRAWN BY DATE	TITLE			
		$\nabla = 0$	3 PLACES ± --- ± ---	2010/04/07 2010/04/13	QLZHANG 2004/12/01	SD MEMORY CARD CONNECTOR NORMAL TYPE(NO PUSH FUNCTION,LEAD-FREE)		
		2 PLACES ± 0.25 ± ---	CHECKED BY DATE	MOLEX MOLEX INCORPORATED				
		1 PLACE ± 0.25 ± ---	2010/04/14	MATERIAL NO. DOCUMENT NO.				
		ANGULAR ± 2 °	APPROVED BY DATE	SHEET NO.				
			XJ.SONG 2010/04/14	67781-8001 SD-67781-004				
				2 OF 3				
				THIS DRAWING CONTAINS INFORMATION THAT IS PROPRIETARY TO MOLEX INCORPORATED AND SHOULD NOT BE USED WITHOUT WRITTEN PERMISSION				

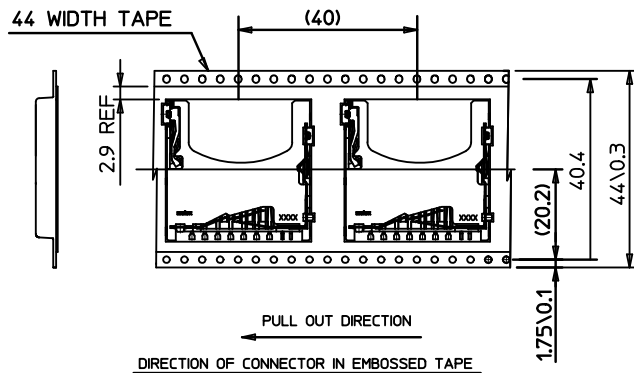
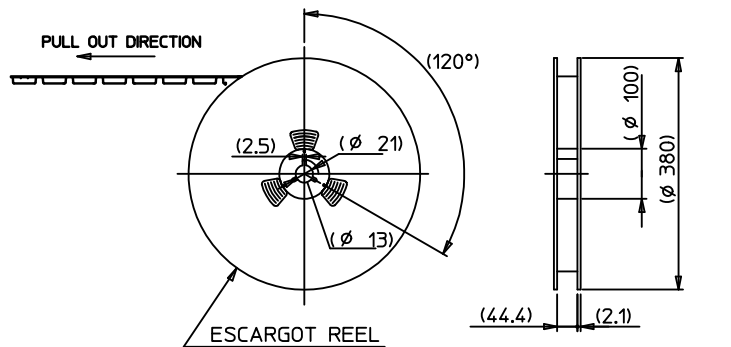

**NOTES**

1. NUMBER OF CONNECTORS: 400 PCS/REEL

2.

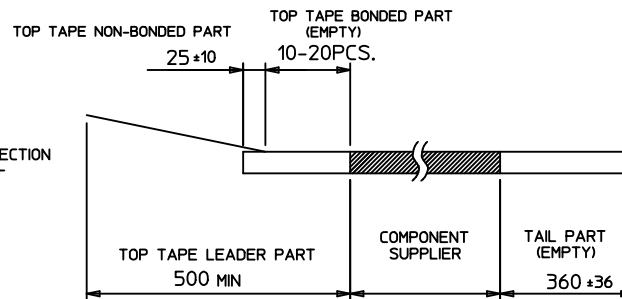

3. PEEL-OFF FORCE OF TOP TAPE: 0.1 - 1.3 N (10.2 - 130gf)  
(PEELING DIRECTION AS SHOWN IN FOLLOWING FIG.)  
<PEEL-OFF SPEED:300mm/min (REF)>

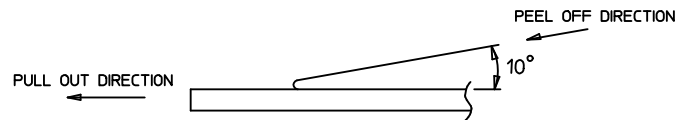

SEE SHEET 1 EC NO: SH2010-0390 DRWN:XQZHANG 2010/04/07 CHKD:GILLI 2010/04/13 APPR:XJSONG 2010/05/18	DESCRIPTION REV	QUALITY SYMBOLS	GENERAL TOLERANCES (UNLESS SPECIFIED)		DIMENSION STYLE		SCALE	DESIGN UNITS	THIRD ANGLE PROJECTION	
			mm	INCH	MM ONLY		1:1	METRIC		
		▽ <sub>A</sub> =0	4 PLACES ± ---	± ---	DRAWN BY	DATE	TITLE			
		▽ <sub>B</sub> =0	3 PLACES ± ---	± ---	QLZHANG	2004/12/01	SD MEMORY CARD CONNECTOR			
▽ <sub>C</sub> =0	2 PLACES ± 0.25	± ---	CHECKED BY	DATE	NORMAL TYPE(NO PUSH FUNCTION,LEAD-FREE)					
▽ <sub>D</sub> =0	1 PLACE ± 0.25	± ---	HARVEY	2004/12/01	MOLEX INCORPORATED					
	ANGULAR ± 2 °		APPROVED BY	DATE	MATERIAL NO.		DOCUMENT NO.		SHEET NO.	
			XJSONG	2010/04/14	67781-8001		SD-67781-004		3 OF 3	
			DRAFT WHERE APPLICABLE MUST REMAIN WITHIN DIMENSIONS			THIS DRAWING CONTAINS INFORMATION THAT IS PROPRIETARY TO MOLEX INCORPORATED AND SHOULD NOT BE USED WITHOUT WRITTEN PERMISSION				
			SIZE							
			A3							