



PART No. EN4SD363012SS

for more information visit
www.hammfg.com

Data subject to change without notice

Isometric drawing Not to Scale



TOP VIEW

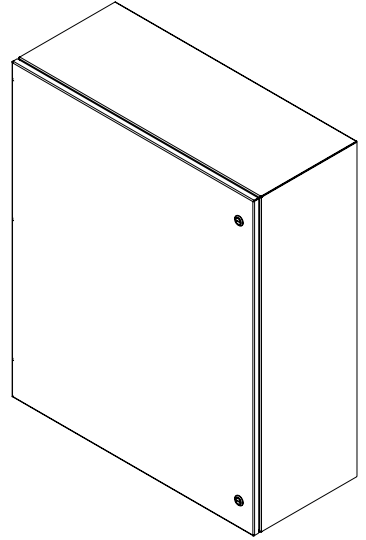

ISOMETRIC VIEW

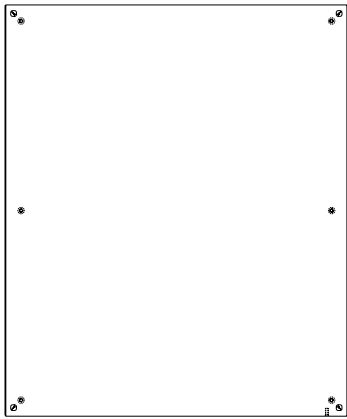

BACK VIEW

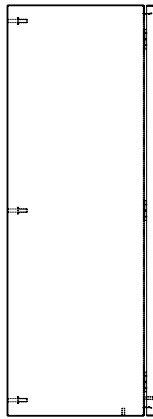

LEFT SIDE VIEW

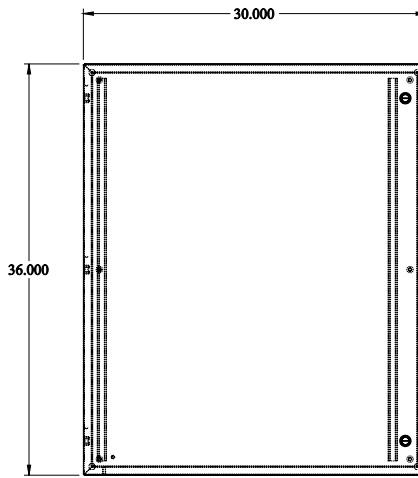

FRONT VIEW

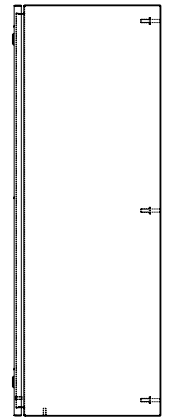

RIGHT SIDE VIEW

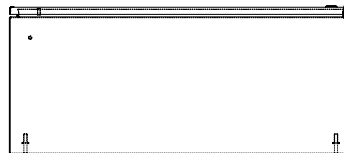

BOTTOM VIEW