

FLAG TERMINAL DIES		TOOLING HEAD (DOCUMENT)	TYPICAL TERMINALS	mm ² CIRCULAR MILL AREA RANGE	NOMINAL WIRE SIZE	
NEST	INDENTER				mm ²	AWG
48506	48505	69067 (408-2454)	322727	6.637-10.539 [13,100-20,800]	7-8	8
48508	48507		321576	10.539-16.771 [20,800-33,100]	13-15	6
48509			321060	16.771-26.653 [33,100-52,600]	21	4
48510			321064	26.653-42.411 [52,600-83,700]	34-35	2
48652	48511		321066	42.411-60.551 [83,700-119,500]	59-60	1/0
48805			321584	60.551-72.259 [119,500-150,500]	67-70	2/0
48806			---	72.259-96.274 [150,500-190,000]	80-95	3/0
48807			321259	96.274-117.049 [190,000-231,000]	100-125	4/0

Figure 1

1. INTRODUCTION

This instruction sheet provides instruction on product application and maintenance and inspection procedures for the SOLISTRAND Flag Terminal crimping dies listed in Figure 1. These dies are used to crimp flag terminals on solid or stranded copper wire sizes 7mm² – 125mm² [8-4/0 AWG]. The dies are used in Hydraulic Head 69067. Read these instructions and all applicable references before

inserting any die assemblies and crimping any terminals.

Refer to Figure 1 for typical SOLISTRAND terminals crimped, as well as the appropriate hydraulic crimping head tooling.



NOTE All dimensions on this document are in metric units [with U.S. customary units in brackets]. Figures and illustrations are for reference only and are not drawn to scale.

2. DESCRIPTION (Figure 1)

Each die assembly consist of a nest and indenter which are retained in the crimping tool by ball plungers. The nest is positioned in the yoke of the crimping tool and the indenter is positioned in the ram of the tool in all applications.

3. DIE ASSEMBLY INSTALLATION AND REMOVAL

Refer to Figure 1 and determine the correct die nest and indenter with the wire size to be used in the crimping tool.

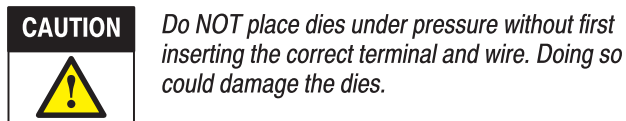
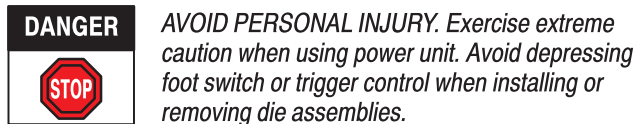

3.1. Die Installation

1. Remove latch pin on head of crimping head and open yoke.
2. Push nest into yoke until nest snaps into position.
3. Activate power unit to advance ram to approximate position shown in Figure 1.
4. Push indenter into ram until indenter snaps into position.
5. Return ram to the down position.
6. Close yoke and insert latch pin.

3.2. Die Removal

1. Remove latch pin and open yoke.
2. Insert blade of screwdriver under nest and pry nest out of yoke.
3. Raise ram to full up position.
4. Insert blade of screwdriver under nest and pry indenter out of ram.

4. WIRE STRIPPING AND CRIMPING PROCEDURE

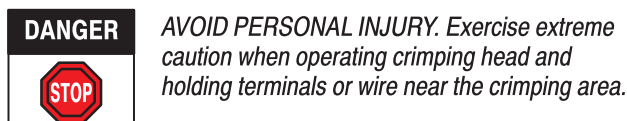

4.1. Wire Stripping

Obtain the correct wire, terminal or splice, and crimping tool (with correct die assembly installed) for your application. Strip wire insulation to the dimensions indicated in Figure 2, taking care not to nick or cut conductor(s), and proceed as follows.

4.2. Crimping Procedure

1. Ensure that wire size stamped on flag terminal corresponds to wire size being used in the application and wire size stamped on nest and indenter.
2. Center flag terminal wire barrel in die nest. When crimping flag terminals in head no. 69067, hold tongue of flag terminals against nest as shown in Figure 2.
3. Activate tool so that ram advances and holds terminal or splice in place but DOES NOT deform wire barrel.
4. Insert stripped wire into terminal until end of conductor is flush with or extended slightly beyond end of wire barrel. See Figure 2.
5. Refer to Paragraph 5.1, Crimp Inspection, for terminal crimp inspection procedure.

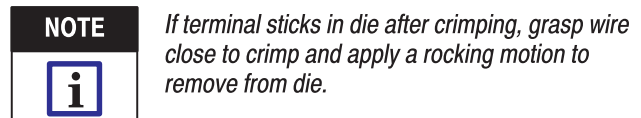

6. Refer to Paragraph 5.1, Crimp Inspection, for terminal crimp inspection procedure.

5. MAINTENANCE AND INSPECTION

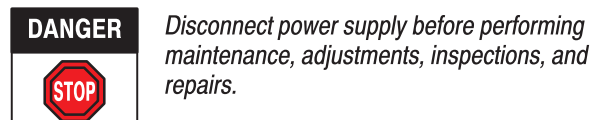

These instructions have been approved by Tyco Electronics Design, Production, and Quality Control Engineers to provide documented maintenance and inspection procedures. Through Tyco Electronics Test Laboratories and the inspection of production assembly, the procedures described herein have been established to ensure quality and reliability of the crimping die assemblies. Customer-replaceable parts are listed in Figure 1. A complete inventory should be stocked and controlled to prevent lost time when replacement of parts is necessary.

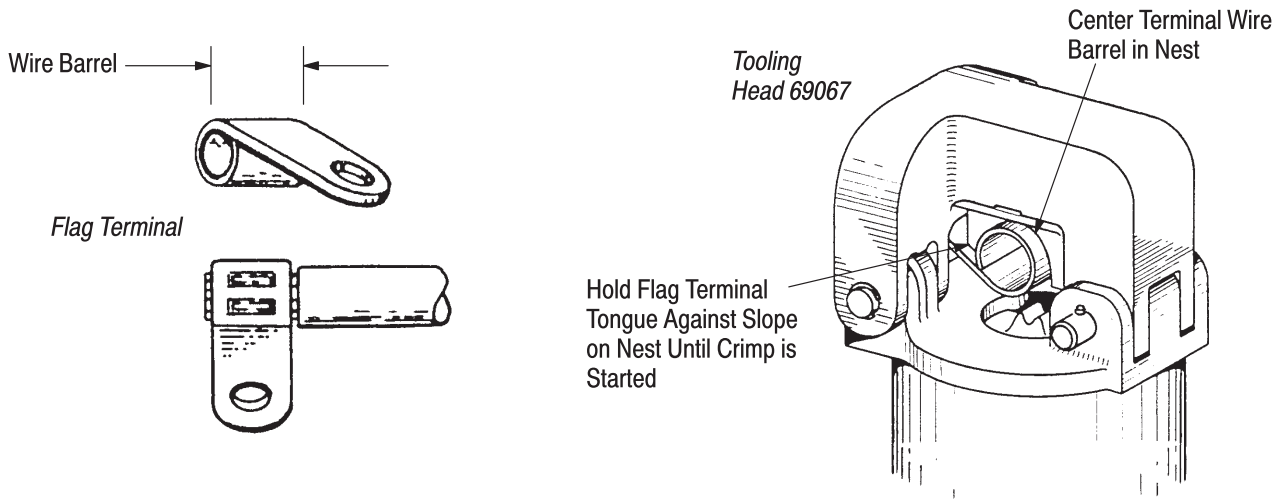

NOMINAL WIRE SIZE		TYPICAL FLAG TERMINALS	STRIP LENGTH	
mm ²	AWG		MINIMUM	MAXIMUM
7-8	8	322727	9.53 [.375]	11.18 [.440]
13-15	6	321576	12.7 [.500]	14.27 [.562]
21	4	321060	13.82 [.544]	15.48 [.609]
34-35	2	321064	17.06 [.672]	18.65 [.734]
59-60	1/0	321066	22.23 [.875]	23.81 [.937]
67-70	2/0	321584	23.81 [.937]	25.40 [1.000]
80-95	3/0	---	26.98 [1.062]	28.58 [1.125]
100-125	4/0	321259	28.58 [1.125]	30.16 [1.187]

Figure 2

5.1. Crimp Inspection (Figure 3)



The accompanying procedure is included as an aid to the tool operator ONLY. It is not intended to serve as a quality control procedure for qualifying finished crimps on flag terminals.

Inspect crimped terminals by checking the features described in Figure 3. Use only terminals that meet the conditions shown in the ACCEPT column. Terminals displaying the features shown in the REJECT column can be avoided by careful use of these instructions and by performing the maintenance and inspection procedures described in Paragraphs 5.2 and 5.3.

5.2. Daily Maintenance

It is recommended that each operator of the dies be made aware of, and responsible for, the following steps of daily maintenance.

1. Remove dust, moisture, and other contaminants from the dies with a clean brush, or a clean, soft, lint-free cloth. Do NOT use objects that could damage the dies.
2. If dies are coated with oil or preservative, wipe clean – particularly in the crimping areas – before placing them in use.
3. When dies are not in use, make certain all surfaces are protected with a THIN coat of any good SAE No. 20 motor oil, and mate and store them in a clean, dry area.

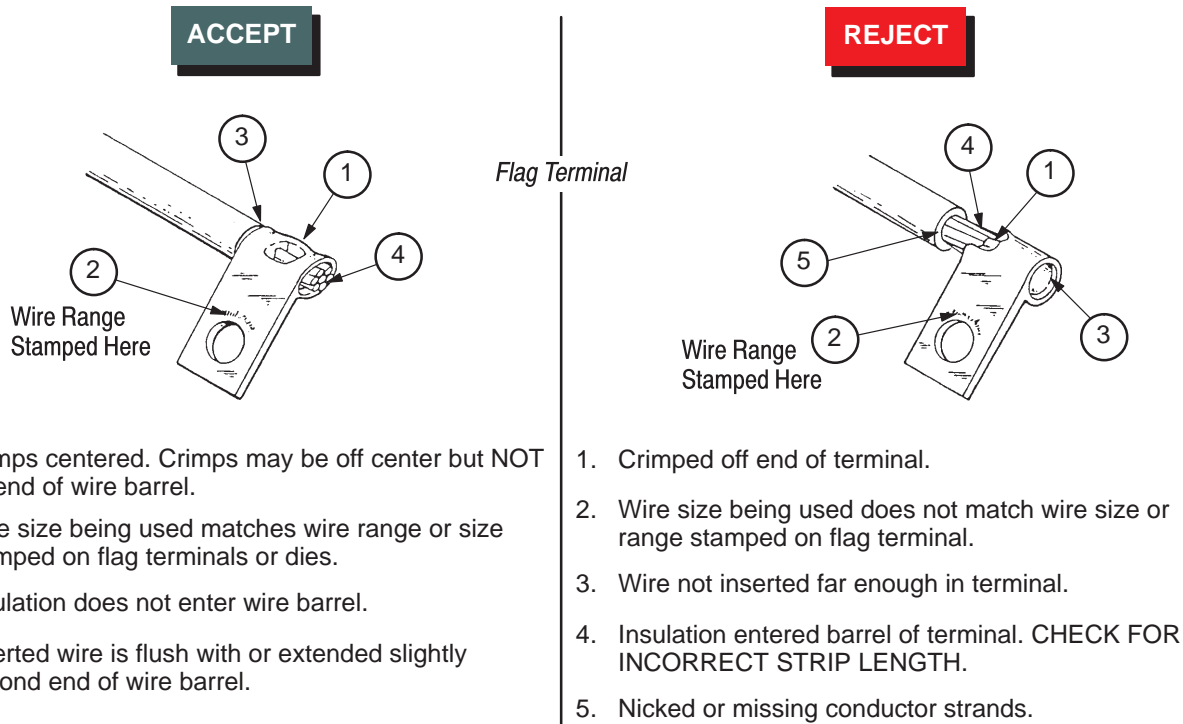

Figure 3

5.3. Periodic Inspection

Regular inspections should be performed by quality control personnel. A record of scheduled inspections should remain with the dies or be made available to supervisory personnel responsible for the dies. Though recommendations call for at least a monthly inspection, the inspection frequency should be based upon the amount of use, working conditions, operator training and skill, and established company standards. These inspections should be performed in the following sequence:

Proceed as follows:

1. Mate the dies until it is evident that they have bottomed. Hold the dies in this position.

CAUTION Do not place dies under pressure at any time.

2. Align the GO element with the wire barrel crimping chamber. Push the element straight into the crimping chamber without using force. The GO element must pass completely through the crimping chamber.

A. Visual Inspection (Figure 4)

1. Remove all lubrication and accumulated film by immersing the dies in a suitable degreaser that will not affect paint or plastic material.
2. Check all surfaces for wear. Inspect the crimp area for flattened, chipped, cracked, worn, or broken areas. See Figure 4. If damage is evident, the die must be replaced. .

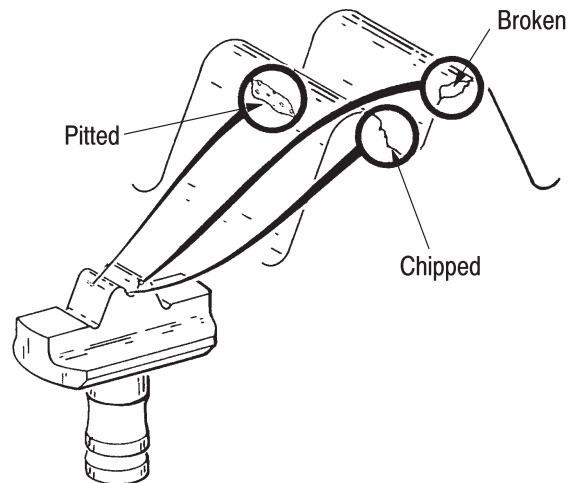

Figure 4

B. Gaging the Crimping Chamber (Figure 5 & Figure 6)

This inspection requires the use of a plug gage conforming to the dimensions in Figure 5. Tyco Electronics does not manufacture or market these gages.

3. Align the NO-GO element and try to insert it straight into the same crimping chamber. The NO-GO element may start entry but must not pass completely through. If the crimping chamber conforms to the gage inspection, the dies are considered dimensionally correct. If not, they must be replaced. For additional information regarding the use of a plug gage, refer to Instruction Sheet 408-7424.

4. When finished gaging, return the dies to their original positions by using a "pressure dump".

6. REPLACEMENT PARTS

Order replacement parts through your Tyco Electronics Representative, or call 1-800-526-5142, or send a facsimile of your purchase order to 1-717-986-7605, or write to:

CUSTOMER SERVICE (38-35)
 TYCO ELECTRONICS CORPORATION
 P.O. BOX 3608
 HARRISBURG, PA 17105-3608



Do not run the pump through a cycle, thus putting the dies under pressure.

Dies may also be returned for evaluation and repair. For die repair service, contact a Tyco Electronics Representative at 1-800-526-5136.

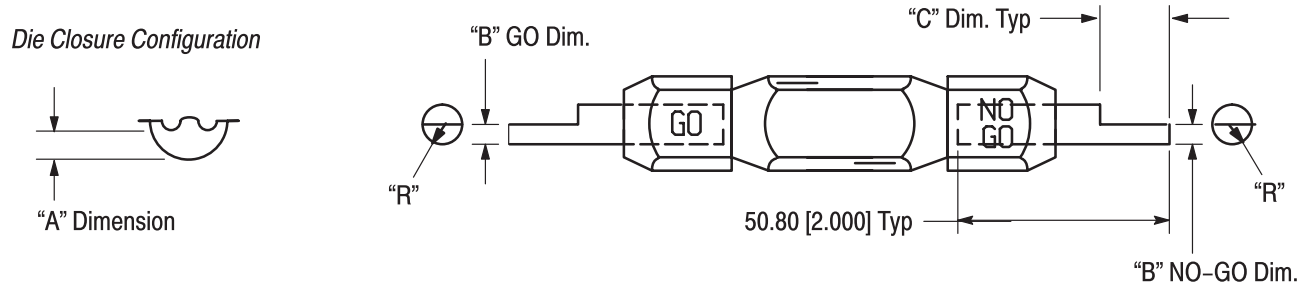

TOOL HEAD (DOCUMENT)	DIE NUMBER	DIE CLOSURE DIMENSION "A"		GAGE ELEMENT DIMENSION "B"		DIMENSION "C"	RADIUS "R"
		GO	NO-GO	GO	NO-GO		
69067 (408-2454)	48506 48505	2.54 [.1000]	2.692 [.1060]	2.54-2.55 [.1000-.1003]	2.689-2.692 [.1059-.1060]	12.70 [.500]	3.58 [.141]
	48508 48507	3.51 [.1380]	3.708 [.1460]	3.505-3.513 [.1380-.1383]	3.705-3.708 [.1459-.1460]	11.099 [.4370]	3.96 [.156]
	48509 48507	4.14 [.1630]	4.343 [.1710]	4.140-4.147 [.1630-.1633]	4.340-4.343 [.1709-.1710]		4.76 [.187]
	48510 48507	4.953 [.1950]	5.156 [.2030]	4.953-4.960 [.1950-.1953]	5.153-5.156 [.2029-.2030]		5.94 [.234]
	48652 48511	6.172 [.2430]	6.375 [.2510]	6.172-6.179 [.2430-.2433]	6.372-6.375 [.2509-.2510]	14.275 [.5620]	7.52 [.296]
	48805 48511	6.959 [.2740]	7.163 [.2820]	6.959-6.967 [.2740-.2743]	7.160-7.163 [.2819-.2820]		8.33 [.328]
	48806 48511	7.823 [.3080]	8.026 [.3160]	7.823-7.830 [.3080-.3083]	8.023-8.026 [.3159-.3160]		9.53 [.375]
	48807 48511	8.788 [.3460]	8.991 [.3540]	8.788-8.796 [.3460-.3463]	8.989-8.991 [.3539-.3540]		10.89 [.421]

Figure 5

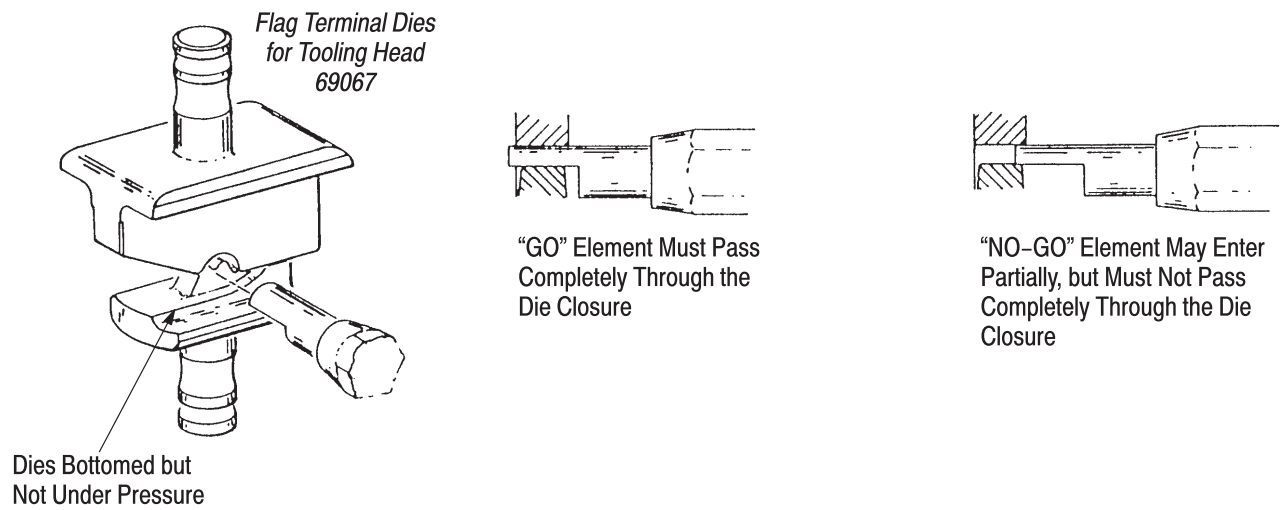

Figure 6

7. REVISION SUMMARY

Since the previous release of this document, the TE logo was applied.