

Introduction

Today's high-performance microprocessors present many challenges to their power source. High power consumption, low bus voltages, and fast load changes are the principal characteristics which have led to the need for a switch-mode DC-DC converter local to the microprocessor.

Intel has specified a Voltage Regulator Module (VRM) for the Pentium Pro Microprocessor [1]. This specification details the requirements imposed upon the input power source(s) by the Pentium-Pro and provides the computer industry with a standard DC-DC converter solution. The Intersil HIP6002 and HIP6003 pulse-width modulator (PWM) controllers are targeted specifically for DC-DC converters powering the Pentium-Pro and similar high-performance microprocessors. The HIP6004 and HIP6005 PWM controllers are enhanced versions of the HIP6002 and HIP6003, with additional features specifically for next-generation microprocessors.

Intersil HIP6004

Figure 1 shows a simple block diagram of the HIP6004. The HIP6004 is the controller for a synchronous-rectified Buck converter. It contains a high-performance error amplifier, a high-resolution 5-bit digital-to-analog converter (DAC), a programmable free-running oscillator, and a pair of N-Channel MOSFET drivers. A more complete description of the part can be found in the HIP6004 Data Sheet [2]. The HIP6005 is very similar to the HIP6004, but is targeted for standard buck converters.

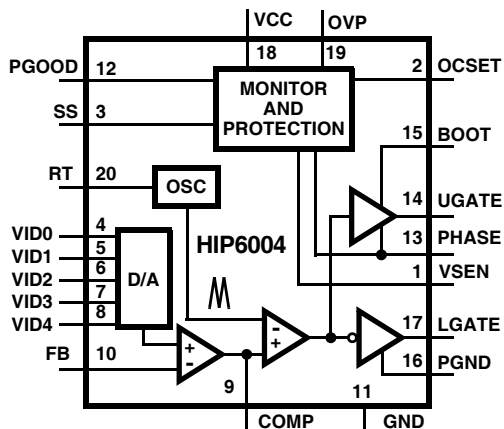

FIGURE 1. BLOCK DIAGRAM OF HIP6004

HIP6004EVAL1 Reference Design

The HIP6004EVAL1 is an evaluation board which highlights the operation of the HIP6004 in an expanded version of the Pentium-Pro VRM. This evaluation board has greater voltage adjustability (1.3V - 3.5V) and higher output current capability (up to 14A) than the Intel-specified Pentium-Pro

VRM. Intersil also offers a Pentium-Pro VRM evaluation board, the HIP6003EVAL1 [3].

HIP6004EVAL1 Features

- Exceeds Intel Pentium-Pro VRM Specifications
 - Form-Factor (3.1" x 1.5" x 1.1")
 - Efficiency
 - Regulation
- Operates in +5V or +12V Input Systems
- 5-Bit DAC with $\pm 1\%$ Accuracy
- Overvoltage Protection via SCR and Fuse
- Overcurrent Protection

Input Voltage Sources

The HIP6004EVAL1 VRM is able to run off either +5VDC or +12VDC main power source. In either case, +12V is required for the bias supply of the HIP6004. The HIP6004EVAL1 is configured to accept a 5V source, as shown in Figure 2. The three approaches for powering the VRM from +12V are:

1. Increase +5V source to +12V (for lab evaluation).
2. Tie 12Vin pins to 5Vin pins (again, lab evaluation).
3. Move F1 fuse as shown in Figure 2 and apply +12Vin (for system implementation).

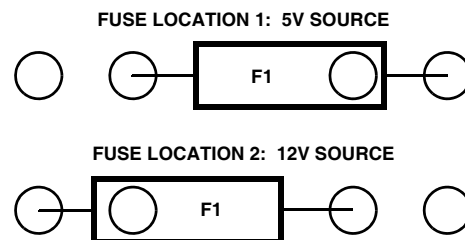

FIGURE 2. INPUT FUSE LOCATION vs INPUT SOURCE VOLTAGE

Output Voltage

The output voltage of the VRM is set by the 5-bit code (VID0 - VID4) programmed by the processor in the system. The DAC internal to the HIP6004 adjusts the internal reference to set the nominal converter output voltage. The output voltage programming is defined in the HIP6004 Data Sheet.

The HIP6004EVAL1 is a solution for many different microprocessors, both present and future. It is capable of supplying greater than 14A of current and provide output voltages from 1.3V to 3.5V.

Efficiency

Figure 3 shows the measured evaluation board efficiency versus load current for four different conditions. The data was taken at room temperature with 100 linear feet per minute (LFM) of airflow.

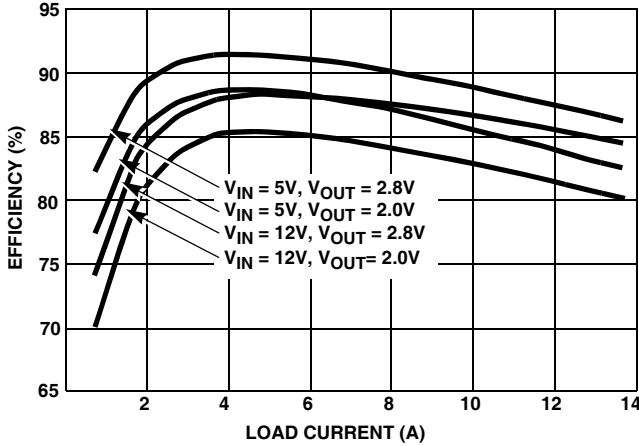

FIGURE 3. EFFICIENCY vs LOAD FOR HIP6004EVAL1

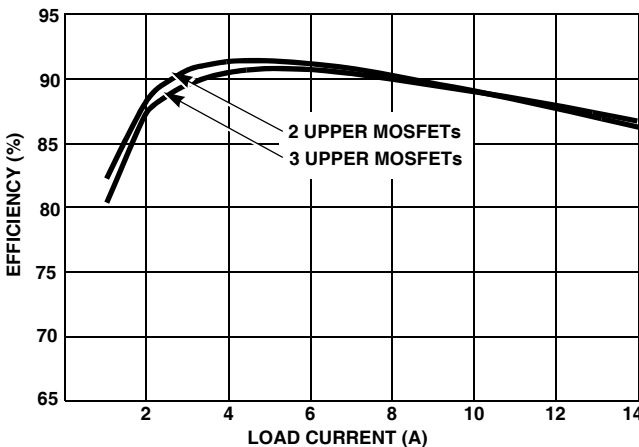

FIGURE 4. COMPARISON OF HIP6004EVAL1 EFFICIENCY WITH 2 UPPER MOSFETs AND 3 UPPER MOSFETs

The HIP6004EVAL1 uses four Intersil RF1K49157 (30V, 30mΩ) MOSFETs, two in parallel for both the main (upper) and synchronous (lower) switches. The board was laid out with provisions for three upper and four lower MOSFETs to allow for greater flexibility in meeting a variety of requirements. However, Figure 3 shows that the VRM provides high efficiency for four different input and output voltage combinations with only two upper and two lower MOSFETs.

Figure 4 compares the efficiency of the HIP6004EVAL1, both with and without an additional upper MOSFET (Q3) populated at $V_{in} = 5V$ and $V_{out} = 2.8V$. This figure shows that a third upper MOSFET has minimal impact on efficiency.

It does spread the main switch power losses across three devices so it does have some thermal advantages. Similar results can be expected for the comparison of two versus three lower MOSFETs when $V_{in} = 12V$.

Thermal Performance

The thermal performance of the VRM is shown in Figure 5. This data is with the following conditions applied:

1. $V_{IN} = 5V$ and $V_{OUT} = 2.8V$.
2. 100 linear feet per minute (LFM) airflow parallel to the plane of the pc board.
3. Ambient temperature = 22°C.

Thermal considerations were a major influence on the design of the HIP6004EVAL1. The use of surface-mount SO-8 MOSFETs means that the pc board traces are also the heat sink. This causes a temperature rise (ΔT) to the pc board, as evidenced in Figure 5. A four-layer board is used to help keep the temperature gradients from exceeding desirable limits. At a 14A load, the pc board ΔT is only about 20°C (measured near the MOSFETs) and the HIP6004 junction temperature is about 67°C.

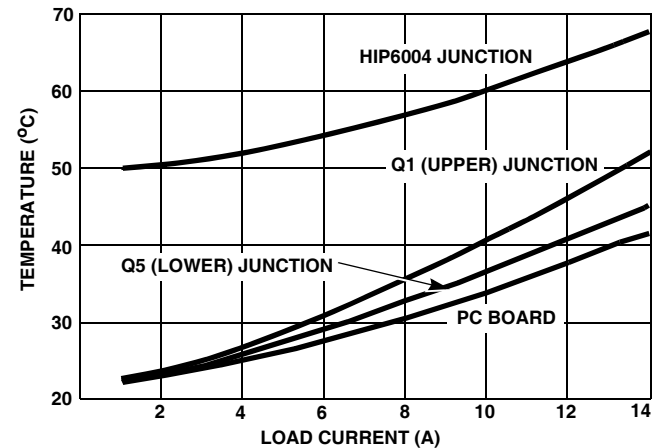

FIGURE 5. THERMAL PERFORMANCE vs LOAD FOR HIP6004EVAL1

Transient Response

Figures 6 and 7 show laboratory oscillograms of the HIP6004EVAL1 in response to a load transient application. The load transient applied was from 0A to 14A. As Figure 6 shows, the output voltage of the VRM (V_{OUT}) remains well within the $\pm 5\%$ regulation window. There is sufficient headroom to allow for worst-case component tolerances (mainly in the equivalent series resistance (ESR) of the output capacitors) and temperature effects. Figure 7 details the positive edge of the load transient application. The bottom trace is the output inductor current (I_L).

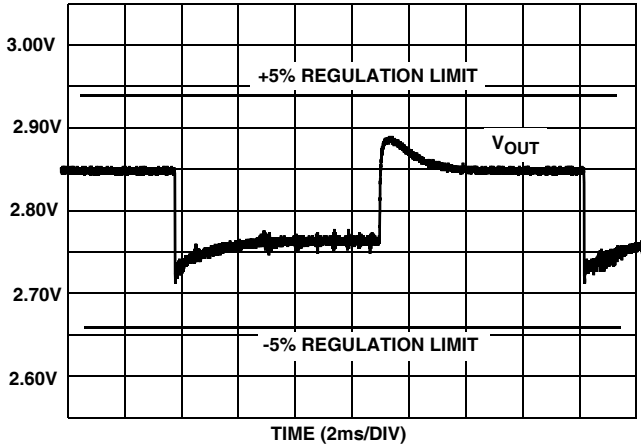

FIGURE 6. HIP6004EVAL1 OUTPUT TRANSIENT RESPONSE

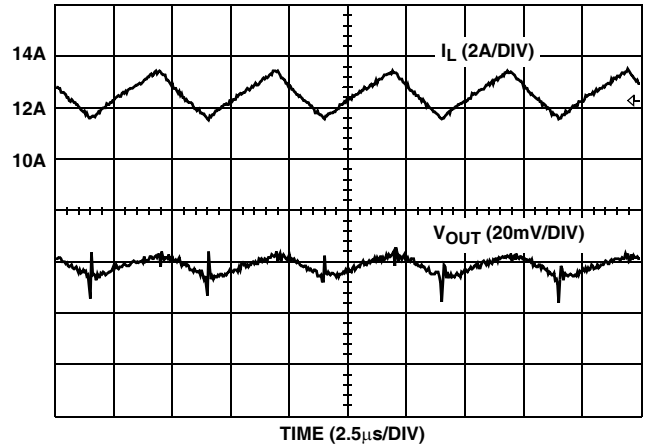

FIGURE 8. OUTPUT VOLTAGE AND INDUCTOR CURRENT RIPPLE WITH $V_{IN} = 5V$, $V_{OUT} = 2.8V$, AND A 12A LOAD CURRENT

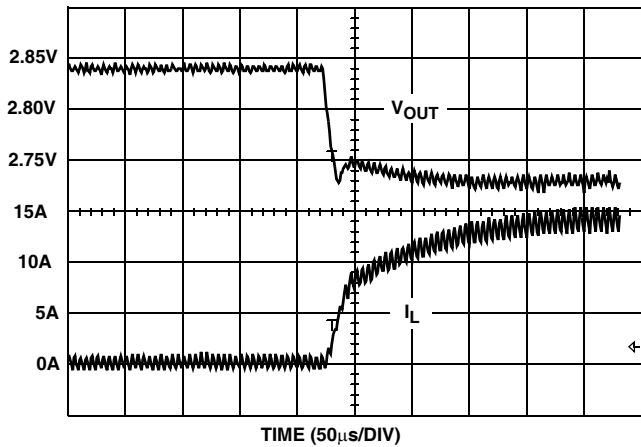

FIGURE 7. 0A TO 14A TRANSIENT RESPONSE

Output Voltage Ripple

The HIP6004EVAL1 has ten parallel output capacitors, mainly to supply the energy during the severe load transients imposed by high-performance microprocessors. This also helps provide a very low output voltage ripple, as shown in Figure 8. With approximately 2A peak-to-peak (p-p) inductor ripple current, the output voltage ripple is only about 12mV_{p-p}. Including noise spikes, the total output deviation with this 12ADC load is about 20mV_{p-p} (measurement is taken with a 20MHz oscilloscope bandwidth).

If the application does not have a highly dynamic load, then the number of output capacitors may be reduced. The output voltage ripple increases with fewer output capacitors. For instance, with just five output capacitors in parallel, the output voltage ripple doubles to approximately 24mV_{p-p}.

Output Voltage Droop with Load

The HIP6004EVAL1 uses a droop function to maintain output voltage regulation through load transients with fewer (or less costly) output capacitors. With a high di/dt load transient typical of the Pentium-Pro microprocessor, the largest deviation of the output voltage is at the leading edge of the transient. The droop function adds a deviation as a function of load that counters the transient deviation.

Figure 9 illustrates the static-load droop characteristic. With no-load, the output voltage is above the nominal output level. The output decreases (or droops) as the load increases.

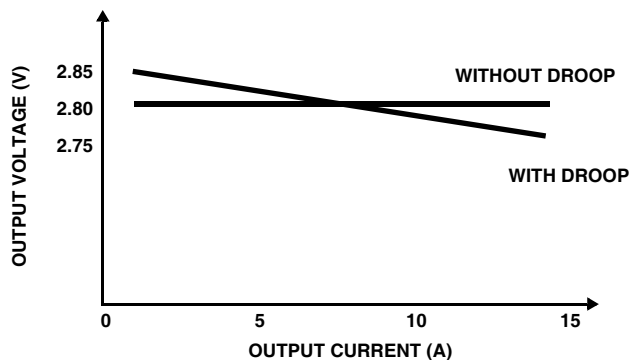

FIGURE 9. STATIC REGULATION OF THE HIP6004EVAL1

With a dynamic load, the droop function pre-biases the output voltage to minimize the total deviation. Prior to the application of load, the output voltage is above the nominal level and the transient deviation results in an output lower than the nominal level. Figure 6 illustrates the droop function performance on the HIP6004EVAL1 converter. The transient deviation is approximately 130mV. At light load, the output voltage is about 50mV higher than the nominal output voltage of 2.8V. At full load, the output voltage is about 40mV lower than nominal. The total deviation is within

$\pm 80\text{mV}$ with the droop function compared to a deviation of over $\pm 130\text{mV}$ without this function. Since the voltage excursions at the transient edges are mainly a function of the output capacitors, the converter uses fewer capacitors.

The HIP6004EVAL1 implements the droop function by using the average voltage drop across the output inductor. The average voltage drop equals the DC output current times the DC winding resistance of the output inductor. Instead of straight voltage feedback, an averaging filter (R8, R9, and C25 in the schematic) is added around the output inductor. This filter communicates both the output voltage and droop information back to the PWM controller. A resistor (R2) increases the light-load voltage above the DAC program level.

OC Protection

The HIP6004EVAL1 has lossless overcurrent (OC) protection. This is accomplished via the HIP6004 current-sense function. The HIP6004 senses converter load current by monitoring the drop across the upper MOSFETs (Q1-2). By selecting the appropriate value of the OCSET resistor (R7), an overcurrent protection scheme is employed without the cost and power loss associated with an external current-sense resistor. The HIP6004 Data Sheet details the design procedure for the OCSET resistor.

OV Protection

The HIP6004EVAL1 contains circuitry to protect against overvoltage conditions. In the case of an overvoltage (greater than 15% over the nominal V_{out}), the HIP6004 fires an SCR (Q8) and the input fuse will open.

For applications where this feature is not necessary, the following components may be eliminated: F1, Q8, and R6. A wire must replace F1 when using HIP6004EVAL1 without OV protection.

Conclusion

The HIP6004EVAL1 is a reference design suitable for a DC-DC converter solution for the Pentium-Pro and other high-performance microprocessors.

References

For Intersil documents available on the internet, see web site <http://www.intersil.com>.

- [1] *Pentium-Pro Processor Power Distribution Guidelines*, Intel Application Note AP-523, November, 1995.
- [2] *HIP6004 Data Sheet*, Intersil Corporation, FN4275.
- [3] AN9664 Application Note, Intersil Corporation, "A Pentium Pro Voltage Regulator Module (VRM) Using the HIP6003 PWM Controller (HIP6003EVAL1)"

Appendix

Board Description

SILK SCREEN - TOP

GND

TOP
SILK SCREEN

GND

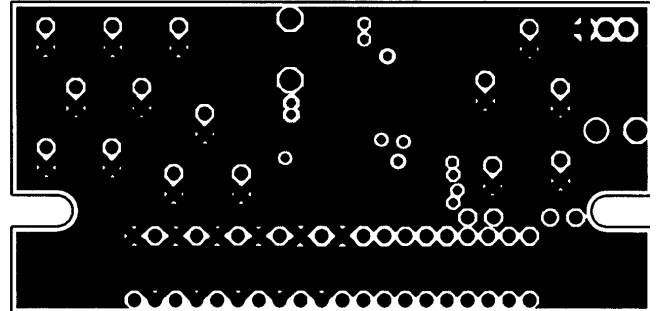
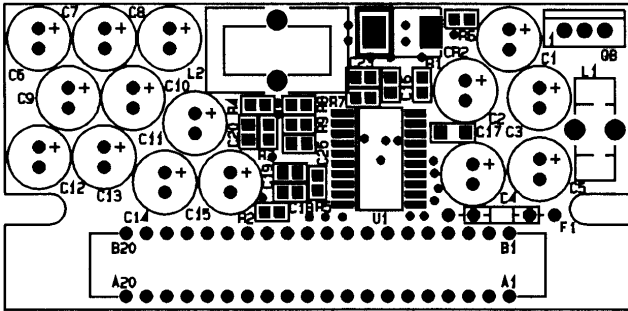

COMPONENT SIDE

SOLDER SIDE

COMPONENT SIDE

SOLDER SIDE

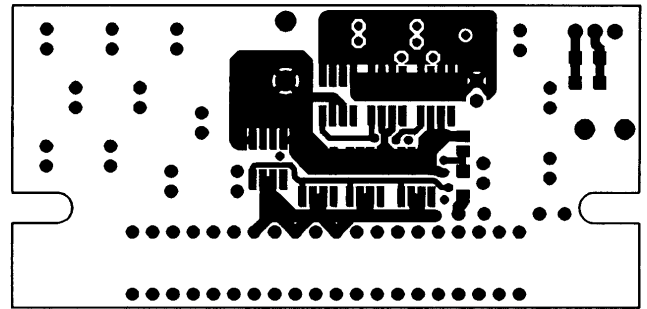
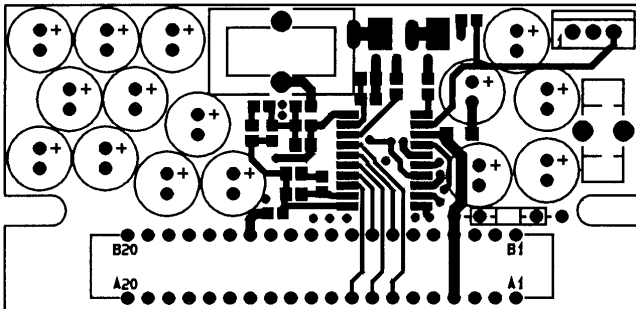

INTERNAL ONE

SILK SCREEN - BOTTOM

INTERNAL ONE

BOTTOM
SILK SCREEN

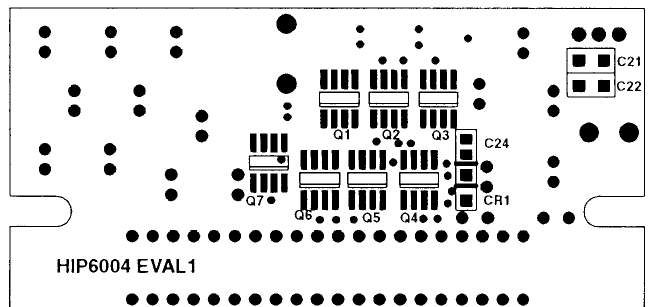
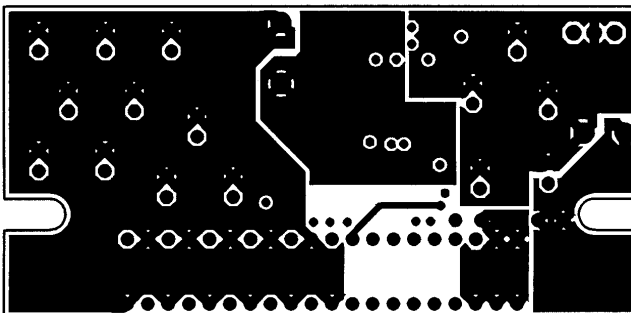

HIP6004 EVAL1

Schematic Diagram

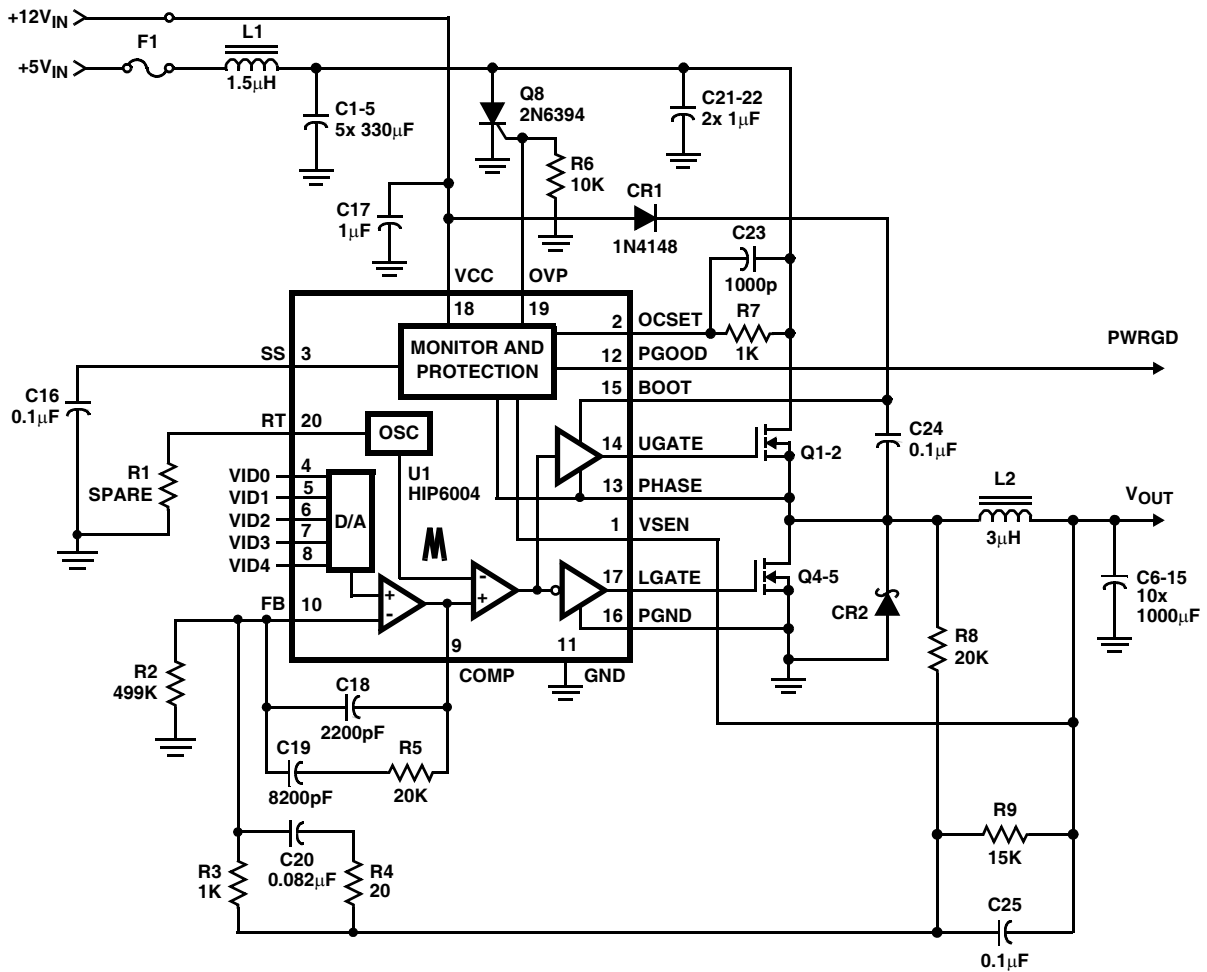

Application Note 9672

Bill of Materials

REFERENCE DESIGNATION	PART NUMBER	DESCRIPTION	MECHANICAL	VENDOR
U1	HIP6004	PWM Controller	SOIC-20	Intersil
Q1-2, 4-5	RF1K49157	MOSFET, 30V, 30mΩ	SOIC-8	Intersil
Q8	2N6394	SCR, 50V, 12A	TO-220	Motorola
CR1	1N4148	Rectifier, 75V	DL-35	
CR2	MBRS340T3	Rectifier, Schottky, 40V, 3A	DO-214AB	Motorola
L1	CTX09-13336-X1 PO344	Inductor, 1.5μH T44-52 Core, 7 Turns of 18 AWG	Thru-Hole	Coiltronics Pulse
L2	CTX09-13313-X1 PO343	Inductor, 3μH T50-52B Core, 10 Turns of 16 AWG	Thru-Hole	Coiltronics Pulse
C1-5	25MV330GX	Capacitor, Al-Elec, 330μF, 25V	Radial, 8 x 20 mm	Sanyo
C6-15	6MV1000GX EEUFA1A102	Capacitor, Al-Elec, 1000μF, 6.3V Capacitor, Al-Elec, 1000μF, 10V	Radial, 8 x 20 mm Radial, 8 x 20 mm	Sanyo Panasonic
C16, 24-25		Capacitor, Ceramic, 0.1μF, X7R	0805	
C18		Capacitor, Ceramic, 2200pF, X7R	0805	
C19		Capacitor, Ceramic, 8200pF, X7R	0805	
C20		Capacitor, Ceramic, 0.082μF, Z5U	0805	
C23		Capacitor, Ceramic, 1000pF, X7R	0805	
C17, 21-22		Capacitor, Ceramic, 1μF, Y5V	1206	
R2		Resistor, 499K, 1%	0805	
R3,7		Resistor, 1K, 1%	0805	
R4		Resistor, 20, 5%	0805	
R5, 8		Resistor, 20K, 5%	0805	
R6		Resistor, 10K, 5%	0805	
R9		Resistor, 15K, 5%	0805	
F1	251015A	Fuse, 15A	Axial	Littlefuse
	532956-7	Connector		Amp

All Intersil U.S. products are manufactured, assembled and tested utilizing ISO9000 quality systems.
Intersil Corporation's quality certifications can be viewed at www.intersil.com/design/quality

Intersil products are sold by description only. Intersil Corporation reserves the right to make changes in circuit design, software and/or specifications at any time without notice. Accordingly, the reader is cautioned to verify that data sheets are current before placing orders. Information furnished by Intersil is believed to be accurate and reliable. However, no responsibility is assumed by Intersil or its subsidiaries for its use; nor for any infringements of patents or other rights of third parties which may result from its use. No license is granted by implication or otherwise under any patent or patent rights of Intersil or its subsidiaries.

For information regarding Intersil Corporation and its products, see www.intersil.com