

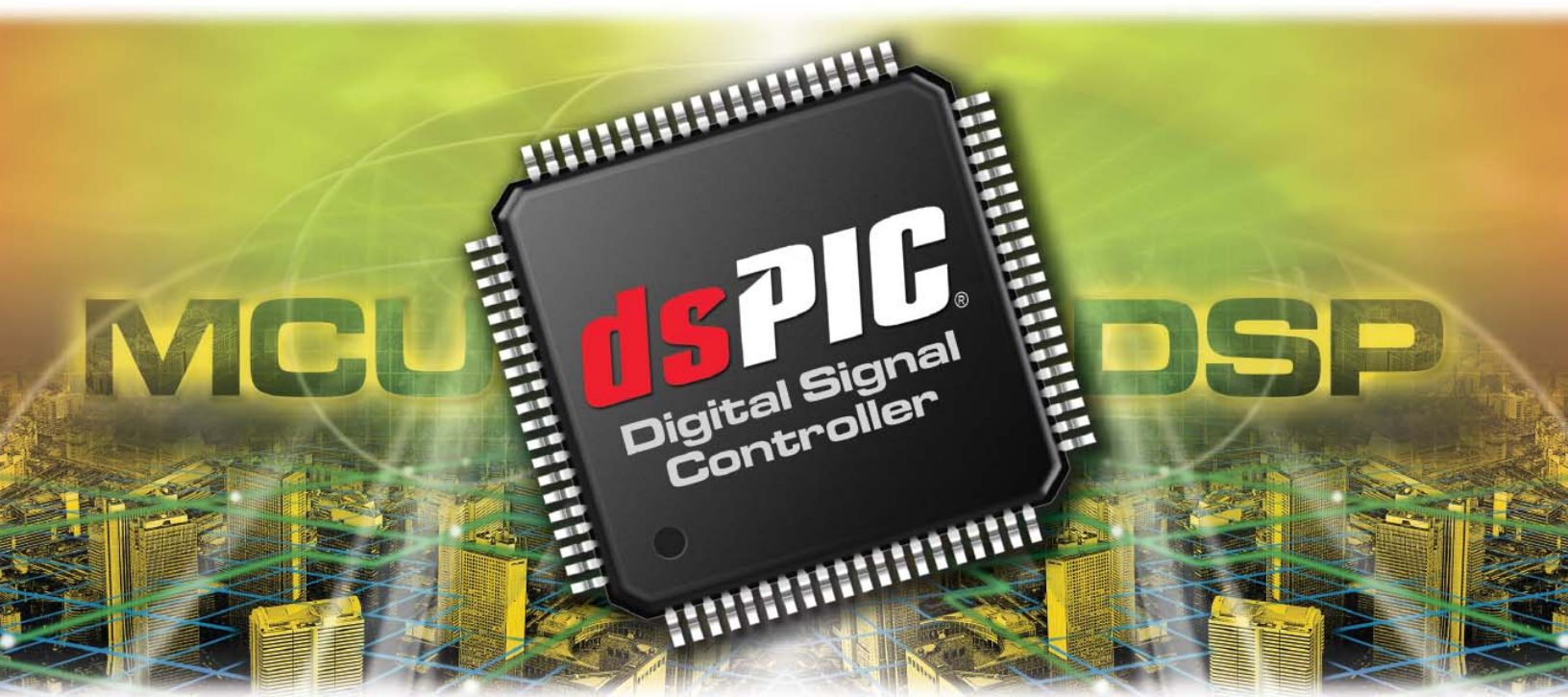

dsPIC30F Digital Signal Controllers

The Best of Both Worlds

April 2005





What is a Digital Signal Controller?

A Digital Signal Controller (DSC) is a single-chip, embedded controller that seamlessly integrates the control attributes of a Microcontroller (MCU) with the computation and throughput capabilities of a Digital Signal Processor (DSP) in a single core.

Microchip's dsPIC[®] DSC offers everything you would expect from a powerful 16-bit MCU: fast, sophisticated and flexible interrupt handling; a wide array of digital and analog peripheral functions; power management; flexible clocking options; power-on-reset; brown-out protection; watchdog timer; code security; full-speed real-time emulation; and full-speed in-circuit debug solutions.

By skillfully adding DSP capability to a powerful 16-bit MCU, Microchip's dsPIC30F family of dsPIC DSCs achieves the best of both worlds and marks the beginning of a new era in embedded control.

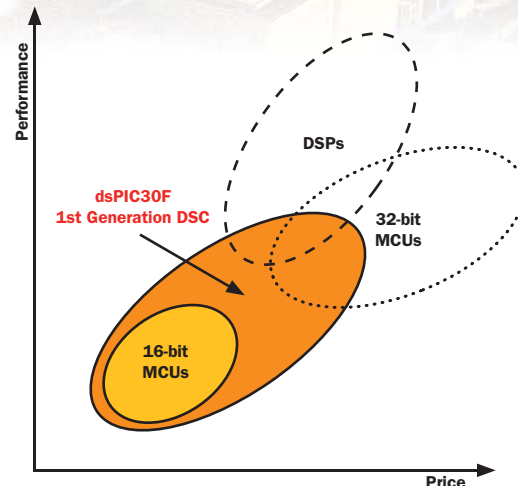

The Capability You Need

Powerful 16-bit MCU:

The dsPIC30F family of devices executes most of its instructions in 1 cycle (33 ns at 30 MIPS). Combine this high instruction throughput with true DSP capabilities, such as single cycle 16-bit multiply and zero overhead looping, and you have the most powerful 16-bit MCU at your command.

Looking to Add DSP?

If you are one of the many MCU users looking to add DSP features to your system, chances are you don't like your choices. Adding a DSP chip to your existing MCU-based system can be costly and complicated. The dsPIC30F is designed to look and feel like an MCU. Adding DSP functionality in the familiar controller-like environment can be accomplished with ease.

Reliable Flash:

The dsPIC30F incorporates Microchip's PEEC Flash process technology with data retention of 40+ years at 85° C, endurance of 1 million cycles typical at 85° C and fast programming time. There is no better Flash technology for embedded control.

Additionally, the dsPIC30F can securely self-program its own Flash memory in a finished product.

DSP for the DSP Expert!

A seasoned DSP developer will be amazed at the capabilities the dsPIC30F family offers — everything you expect from a DSP of its class: dual 40-bit accumulators, single-cycle 16 x 16 MAC, 40-bit barrel shifter, dual operand fetches, saturation and rounding modes and DO and REPEAT loops. Then we added a few items usually missing from DSPs: flexible interrupts, large register sets, a watchdog timer, clock fail detect and real-time emulation to name a few.

Optimized C Compiler:

The dsPIC30F architecture was co-developed by our MPLAB[®] C30 C Compiler team. The result is a high C code efficiency when compared to any 16-bit MCU or DSP.

C code benchmarks show that competitive 16-bit MCUs require up to double the amount of program code space for the same application program written in C.

Considering a 32-bit MCU?

Considering a 32-bit controller because your current MCU has run out of steam?

The dsPIC30F with integrated DSP can outperform a 32-bit controller in many applications. Our outstanding C code efficiency for 32-bit data type reduces memory requirements and cost.

Future dsPIC30F variants with larger program memory are in development to give you a long-term roadmap with the dsPIC DSC architecture.

Best of Both Worlds

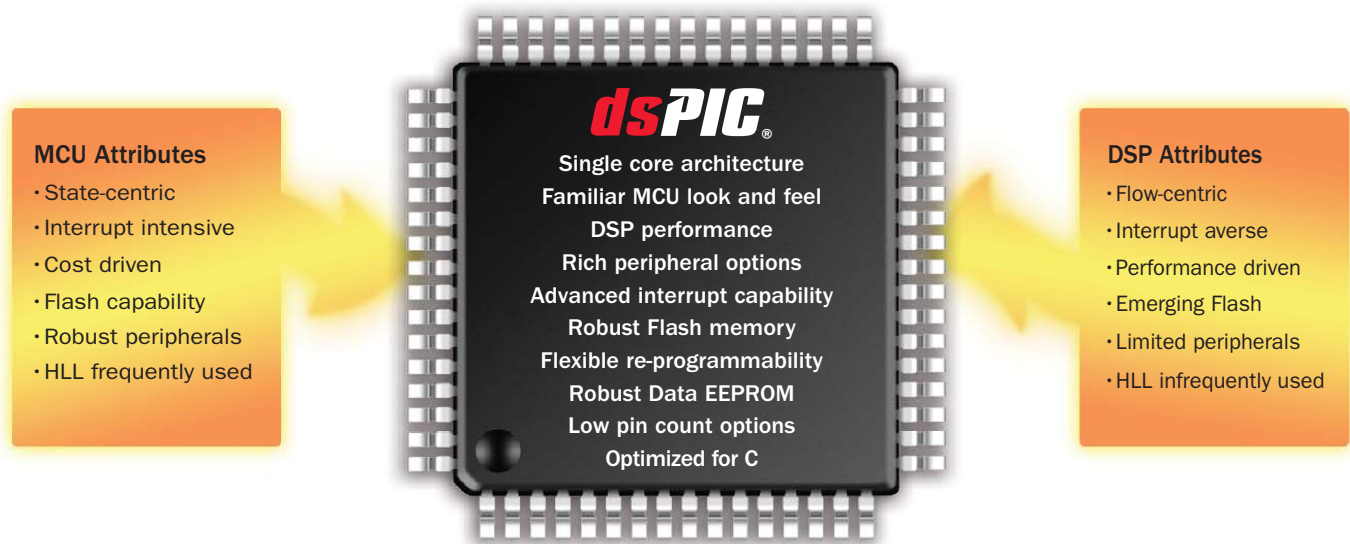

Bridging the Performance Gap

Microchip's dsPIC30F places unprecedented performance in the hands of 16-bit MCU designers. The dsPIC DSC has the "heart" of a 16-bit MCU with robust peripherals and fast interrupt handling capability and the "brain" of a DSP that manages high computation activities, creating the optimum single-chip solution for embedded system designs. This enables you to add powerful new features to your product and integrate functions to save board space.

Outstanding MCU Performance

The first 16-bit MCUs were developed to overcome the native 64 KB boundary imposed by 8-bit MCUs. The need for advanced performance was not contemplated in these early architectures. When the need for improved performance became obvious, next-generation devices were developed, but were constrained by backward compatibility requirements and legacy issues.

Developed from the ground up, the dsPIC DSC addresses traditional 16-bit requirements without sacrificing performance. It combines state-of-the-art 16-bit MCU performance in its general-purpose register-based core with all the features you need for DSP operations.

Competitive DSP Performance

The dsPIC30F balances its outstanding MCU qualities with competitive DSP performance. All the features you require from a high performance, robust DSP are effortlessly integrated in the dsPIC DSC.

Function	Cycle Count Equation	Conditions*	Number of Cycles	Execution Time @30 MIPS
Complex FFT**	—	N=64	3739	124.6 μs
Complex FFT**	—	N=128	8485	282.8 μs
Complex FFT**	—	N=256	19055	635.2 μs
Single Tap FIR	—	—	1	33 ns
Block FIR	53+N(4+M)	N=32, M=32	1205	40.2 μs
Block FIR Lattice	41+N(4+7M)	N=32, M=32	7337	244.6 μs
Block IIR Canonic	36+N(8+7S)	N=32, S=4	1188	39.6 μs
Block IIR Lattice	46+N(16+7M)	N=32, M=8	2350	78.3 μs
Matrix Add	20+3(C*R)	C=8, R=8	212	7.1 μs
Matrix Transpose	16+C(6+3(R-1))	C=8, R=8	232	7.7 μs
Vector Dot Product	17+3N	N=32	113	3.8 μs
Vector Max	19+7(N-2)	N=32	229	7.6 μs
Vector Multiply	17+4N	N=32	145	4.8 μs
Vector Power	16+2N	N=32	80	2.7 μs
PID Loop Core	—	—	7	231 ns
*C= #columns, N=# samples, M=#taps, S=#sections, R=#rows				
**Complex FFT routine inherently prevents overflow				
1 cycle = 33 nanoseconds @ 30 MIPS				

dsPIC30F Family Block Diagram

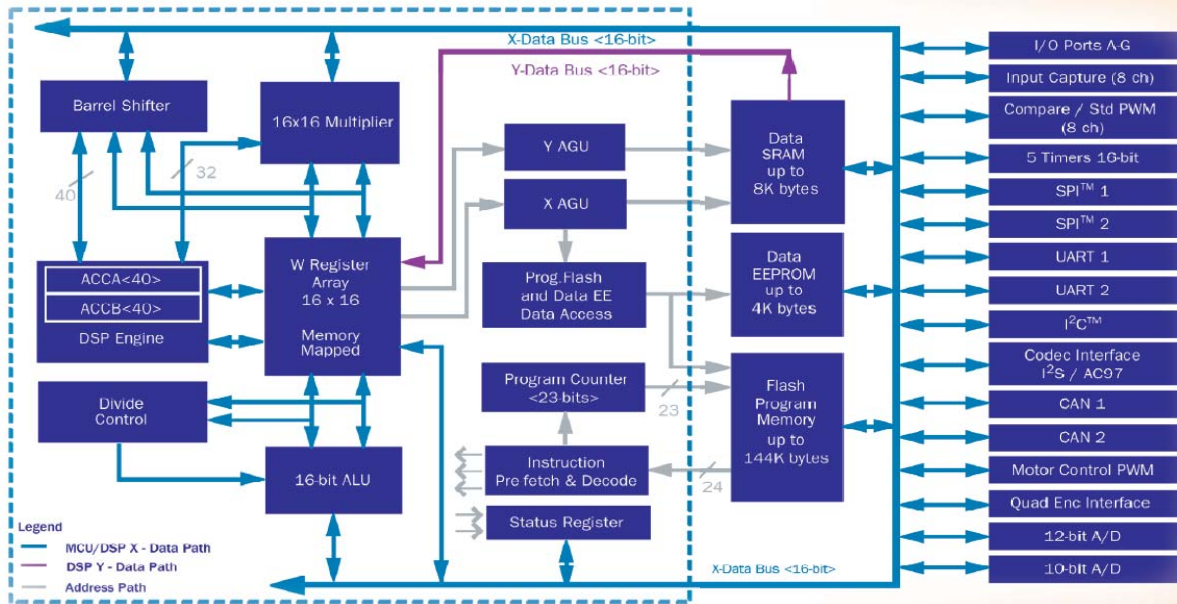

dsPIC30F Features Overview

Operating Range

DC to 30 MIPS*
Wide V _{DD} range: 2.5 - 5.5V
Ind. (-40° to 85° C) and ext. (-40° to 125°C)
*30 MIPS @ 4.5-5.5V, -40° to 85° C

High Performance DSC CPU

Single core combines MCU and DSP features
C compiler optimized instruction set
16-bit wide data path
24-bit wide instructions
84 base instructions: mostly 1 word/1 cycle
16 16-bit general purpose registers
2 40-bit accumulators
• With rounding and saturation options
Flexible and powerful addressing modes
• Indirect, modulo and bit-reversed
Software stack
16 x 16 fractional/integer multiplier
32/16 and 16/16 divide
Single cycle multiply-and-accumulate
40-stage barrel shifter

Power Management

Switch between clock sources in real-time
Programmable power-on reset start up
Programmable low-voltage detect
Programmable brown-out reset
Idle and Sleep modes with fast wake-up

Digital I/O

Up to 54 programmable digital I/O pins
Wake-up/Interrupt-on-change on up to 24 pins
25 mA sink and source on all I/O pins

On-Chip Flash, Data EEPROM and SRAM

Flash program memory: up to 144 KB
• 100K erase/write cycles typical
Data EEPROM: up to 4 KB
• 1 million erase/write cycles typical
Data SRAM: up to 8K bytes

System Management

Flexible clock options:
• Primary external clock, crystal, resonator
• Secondary external lower power (32 kHz crystal oscillator)
• Internal RC: fast or low power
• Integrated PLL (4x, 8x, 16x)
– Low jitter PLL
– PLL sourced by ext. & int. clock sources
Programmable power-up timer
Oscillator start-up timer/stabilizer
Watchdog Timer with its own RC oscillator
Clock switching/fail-safe clock monitor

Interrupt Controller

5 cycle fixed latency
Up to 45 interrupt sources, up to 5 external
7 programmable priority levels
4 processor exceptions and software traps

Timers/Capture/Compare/PWM

Timer/counters: up to five 16-bit timers
• Can pair up to make 32-bit timers
• 1 timer runs as real-time clock with external 32 kHz oscillator
Input capture: up to 8 channels
• Capture on rising, falling or both edges
• 4-deep FIFO on each capture
Output compare: up to 8 channels
• Single or dual 16-bit compare mode
• 16-bit glitchless PWM mode

Communication Modules

3-wire SPI™: up to 2 modules
• Framing supports I/O interface to simple codecs
I²C™ full multi-master, slave mode support
• 7-bit and 10-bit addressing
• Bus collision detection and arbitration
UART: up to 2 modules
• Interrupt-on-address bit detect
• Wake-up on Start bit from Sleep mode
• 4-character TX and RX FIFO buffers
Codec interface module
• Supports I²S and AC97 protocols
CAN 2.0B active: up to 2 modules
• 3 transmit and 2 receive buffers
• Wake-up on CAN message

Motor Control Peripherals

Motor Control PWM: up to 8 outputs
• 4 duty cycle generators
• Independent or complementary mode
• Programmable dead time settings
• Edge or center-aligned
• Manual output override control
• Up to 2 fault inputs
• A/D samples triggered by PWM module
Quadrature encoder interface module
• Phase A, Phase B and index pulse input

Analog-to-Digital Converters *Enhanced!*

10-bit, 1 Msps A/D converter module
• 2 or 4 simultaneous samples
• Up to 16 input channels with auto scanning
• 16 deep result buffer
• Conversion possible in Sleep mode
12-bit, 200 kpsps A/D converter module
• Up to 16 input channels with auto scanning
• 16 deep result buffer
• Conversion possible in Sleep mode
±1 LSB accuracy

dsPIC30F Product Families

General Purpose Family

The dsPIC30F General Purpose Family is ideal for a wide variety of 16-bit MCU embedded applications. In addition, the variants with codec interfaces are well suited for audio applications.

Product	Pins	Program Memory K Bytes	SRAM Bytes	EE-PROM Bytes	Timer 16-bit	Input Capture	Output Compare/Standard PWM	Codec Interface	A/D 12-bit 200 ksps	UART	SPI™	I ² C™	CAN	I/O Pins (Max.)*	Package Code
dsPIC30F3014	40/44	24	2048	1024	3	2	2	—	13 ch	2	1	1	—	30	P, PT, ML
dsPIC30F4013	40/44	48	2048	1024	5	4	4	AC97, I ² S	13 ch	2	1	1	1	30	P, PT, ML
dsPIC30F5011	64	66	4096	1024	5	8	8	AC97, I ² S	16 ch	2	2	1	2	52	PT
dsPIC30F6011	64	132	6144	2048	5	8	8	—	16 ch	2	2	1	2	52	PF
dsPIC30F6012	64	144	8192	4096	5	8	8	AC97, I ² S	16 ch	2	2	1	2	52	PF
dsPIC30F5013	80	66	4096	1024	5	8	8	AC97, I ² S	16 ch	2	2	1	2	68	PT
dsPIC30F6013	80	132	6144	2048	5	8	8	—	16 ch	2	2	1	2	68	PF
dsPIC30F6014	80	144	8192	4096	5	8	8	AC97, I ² S	16 ch	2	2	1	2	68	PF

Motor Control and Power Conversion Family

This dsPIC30F family supports motor control applications, such as brushless DC motors, single and 3-phase induction and switch reluctance motors. These are also ideal for UPS, inverters, switched mode power supplies and power factor correction.

Product	Pins	Program Memory K Bytes	SRAM Bytes	EE-PROM Bytes	Timer 16-bit	Input Capture	Output Compare/Standard PWM	Motor Control	A/D 10-bit 1 Msps	Quadrature Encoder	UART	SPI™	I ² C™	CAN	I/O Pins (Max.)*	Package Code
dsPIC30F2010	28	12	512	1024	3	4	2	6 ch	6 ch	Yes	1	1	1	—	20	SP, SO, MM
dsPIC30F3010	28	24	1024	1024	5	4	2	6 ch	6 ch	Yes	1	1	1	—	20	SP, SO, 44-pin ML
dsPIC30F4012	28	48	2048	1024	5	4	2	6 ch	6 ch	Yes	1	1	1	1	20	SP, SO, 44-pin ML
dsPIC30F3011	40/44	24	1024	1024	5	4	4	6 ch	9 ch	Yes	2	1	1	—	30	P, PT, ML
dsPIC30F4011	40/44	48	2048	1024	5	4	4	6 ch	9 ch	Yes	2	1	1	1	30	P, PT, ML
dsPIC30F5015	64	66	2048	1024	5	4	4	8 ch	16 ch	Yes	1	2	1	1	52	PT
dsPIC30F5016	80	66	2048	1024	5	4	4	8 ch	16 ch	Yes	1	2	1	1	68	PT
dsPIC30F6010	80	144	8192	4096	5	8	8	8 ch	16 ch	Yes	2	2	1	2	68	PF

Sensor Family

The dsPIC30F Sensor Family products have features designed to support high-performance, low-cost embedded control applications. The 18- and 28-pin packages are designed to fit space-critical applications.

Product	Pins	Program Memory K Bytes	SRAM Bytes	EE-PROM Bytes	Timer 16-bit	Input Capture	Output Compare/Standard PWM	A/D 12-bit 200 ksps	UART	SPI™	I ² C™	I/O Pins (Max.)*	Package Code
dsPIC30F2011	18	12	1024	—	3	2	2	8 ch	1	1	1	12	P, SO, 28-pin ML
dsPIC30F3012	18	24	2048	1024	3	2	2	8 ch	1	1	1	12	P, SO, 44-pin ML
dsPIC30F2012	28	12	1024	—	3	2	2	10 ch	1	1	1	20	SP, SO, 28-pin ML
dsPIC30F3013	28	24	2048	1024	3	2	2	10 ch	2	1	1	20	SP, SO, 44-pin ML

* Maximum I/O pin count includes pins shared by the peripheral functions.

dsPIC30F Packages

Microchip dsPIC30F packages are shown in various configurations:

- MM: 28-pin QFN** (6 mm x 6 mm x 0.9 mm)
- ML: 44-pin QFN** (8 mm x 8 mm x 0.9 mm)
- ML: 28-pin QFN** (6 mm x 6 mm x 0.9 mm)
- P: 18-pin PDIP** (22.81 x 7.95 x 3.3 mm)
- SO: 18-pin SOIC** (11.53 x 10.34 x 2.31 mm)
- P: 40-pin PDIP** (52.27 x 15.24 x 3.81 mm)
- PT: 64-pin TQFP** (10 mm x 10 mm x 1 mm)
- PF: 64-pin TQFP** (14 mm x 14 mm x 1 mm)
- SP: 28-pin SPDIP** (34.67 x 7.87 x 3.3 mm)
- SO: 28-pin SOIC** (17.88 x 10.34 x 2.31 mm)
- PT: 44-pin TQFP** (10 mm x 10 mm x 1 mm)
- PT: 80-pin TQFP** (12 mm x 12 mm x 1 mm)
- PF: 80-pin TQFP** (14 mm x 14 mm x 1 mm)

Images are approximately to scale.

Designed for real-time control, the dsPIC DSC offers outstanding reliability, robustness and reduced system cost

125° ambient operation

All dsPIC DSCs operate up to 125°C ambient temperature, making these ideal for industrial applications that run “hot” such as motor control, power conversion, lighting control as well as “under the hood” automotive systems such as EHPS, electronic gearbox, cooling fan control, etc.

25 mA I/O drive saves cost

Each I/O pin sources or sinks 25 mA, making it possible to drive LEDs directly or eliminate pre-drivers for external FET switches to save you space and cost.

Reliable watchdog timer

Flash configuration bits are used to enable the watchdog timer and select its period. Software cannot disable it; as it runs from its own internal oscillator, independent of the system clock. Now that is a reliable watchdog.

On-chip system clock monitor adds safety

The dsPIC DSC’s on-chip clock monitor detects system clock failure and forces a chip-reset. Restarting the system with the on-chip oscillator (FRC) provides a graceful way to handle such a catastrophic failure.

On-chip oscillator eliminates crystal, reduces cost

The dsPIC DSC’s on-chip precision oscillator (FRC: 7.5 MHz, $\pm 1.5\%$ over V_{DD} and temperature) can be the clock source for many systems. In several dsPIC DSCs, the PLL can boost the clock speed and still meet $\pm 2\%$ accuracy. Now you can eliminate the external crystal, save board space and reduce system cost.

Power save modes optimizes power consumption

The dsPIC DSC offers many ways to optimize power consumption. Switch to a low frequency on-chip oscillator or divide down the system clock during periods of inactivity. Go into “power-down” mode to shut down all clocks to reduce current draw to microamperes yet allow a quick wake-up on interrupt.

Low Jitter PLL for reliable system operation

On-chip PLL with crystal oscillator input offers low jitter, $< \pm 0.75\%$ over V_{DD} and temperature for reliable operation of CAN or other forms of communication.

Small package – big performance

Several dsPIC DSCs come in QFN packages as small as 6 x 6 mm or 8 x 8 mm and only 0.9 mm high. Now you add 16-bit performance in the tiniest of places.

Power-on Reset and Brown-out Reset add robustness, saves cost

Intelligent on-chip Power-on Reset eliminates external reset circuit in most systems. Vary the reset period to allow for different crystal start-up delays. Brown-out protection, if enabled, resets the chip in the event of a power glitch. All this adds up to a robust system at a reduced cost.

Self-monitoring CPU protects against software glitches

Code execution flow is continually monitored to prevent catastrophic failures due to software malfunction. Accesses to non-existing memory locations are trapped, as are stack overflow, stack underflow and un-initialized pointer accesses. Unimplemented op codes execute as NOPs to avoid unpredictable behavior. Now your real-time system has an added level of safety.

The dsPIC DSC is designed to meet the rigorous demands of real-time systems. Not only is its real-time performance superior compared to other 16- and 32-bit controllers, it also offers a number of highly enabling features specifically designed to enhance system reliability and robustness, and reduce system cost by eliminating external components.

One Architecture, Many Solutions

The versatile dsPIC30F family provides solutions for embedded control applications and offers a wide variety of digital and analog peripheral modules. Choose a high pin count, high-density memory dsPIC30F device as a main controller in a large, complex embedded system. Or select a small pin count, small package device to tackle a single motor or a sensor. No other 16-bit MCU or DSP family gives you so much flexibility.

Invest in the dsPIC30F family once and reap the benefits of having a single platform over many applications.

Motor Control

The dsPIC30F is ideal for motors requiring more than a basic microcontroller. Whether you need a little more computation power or full DSP capability, the dsPIC30F delivers.

Apply the dsPIC30F for sensorless control, precision speed/position/servo control, torque management, variable speed motors, high RPM motors, variable load applications, noise reduction or energy efficiency improvement. Brushless DC, AC induction or switch reluctance motors are ideal candidates for the dsPIC30F family of controllers.

Applications:

- Heating, ventilation and air conditioning
- Absolute encoders and resolvers
- Blowers and lawn equipment
- Electronic Power Steering
- Industrial gate openers
- Seat belt tensioners
- Exercise equipment
- Washing machines
- Sewing machines
- Industrial pumps
- Stability control
- Power tools
- Refrigeration
- Printing machines

Enabling Features of the dsPIC30F:

- 1 or 2 fault pins
- 28-, 40-, 64- and 80-pin variants
- 6 or 8 motor PWM output
- Complementary or independent PWM
- Center-aligned or edge-aligned PWM
- A/D sampling synchronized to PWM cycle
- 10-bit, 1 Msps A/D converter
- 2 or 4 simultaneous A/D samples
- 5V native operation for noisy environments
- On-chip Quadrature Encoder Interface (QEI)
- Motor control algorithm reference designs
- Up to 2 programmable dead time settings

Internet Connectivity

If your embedded control system needs to be connected to the Internet or to a dial-up phone line, the dsPIC30F provides you with a single chip solution. The “ready-to-use” TCP/IP Ethernet driver and soft modem application libraries enable you to add connectivity to your design.

Applications:

- Remote diagnostics of industrial equipment
- Remote medical equipment
- Water, gas and electric meters
- Industrial gate openers
- Remote monitoring
- Vending machines
- Power line modems
- Security systems
- Set top boxes
- Internet speakers

Enabling Features of the dsPIC30F:

- UART interface
- TCP/IP Software Library
- Soft Modem Library (V.32bis/V.22bis)
- Encryption libraries
- Ethernet driver software
- RTOS for multitasking
- Reduced board space
- Reduced total system cost

Sensor Control

The 18- and 28-pin small footprint dsPIC30F parts are ideal for advanced sensor control. The combination of a 12-bit A/D converter, communication peripherals, power management features and DSP capability makes it possible to create intelligent sensor interface modules. These devices can also assist an overloaded central controller.

Applications:

- Advanced 2-D PIR detection
- Chemical and gas sensors
- Glass break detectors
- Gyroscopic modules
- Knock detection
- Vibration sensors
- Pressure sensors
- Torque sensors
- Coin acceptors
- Magnetic sensors
- Ultrasonic sensors

Enabling Features of the dsPIC30F:

- Data EEPROM
- DSP capability
- High speed input capture
- Small footprint 18- or 28-pin packages
- 12-bit, 200 ksps A/D converter
- SPI™, I²C™ and UART communication ports
- Visual digital filter design tool
- Configurable Flash memory can update algorithms

Automotive

Microchip is an ISO/TS 16949:2002 qualified supplier to major automotive manufacturers. Most of our products are available for automotive-grade temperature requirements and support a long product life cycle.

Available in 18- to 80-pin packages, the dsPIC30F family is ideal for a variety of automotive applications from a large central controller to small sensor interface or peripheral processor.

Applications:

- Electrically assisted hydraulic steering
- Electronic clutch and gearboxes
- Roll and stability controllers
- Seat belt pretensioners
- Electronic power steering
- Cabin noise cancellation
- Advanced battery monitors
- Airbag main controllers
- Ignition controllers
- Side impact airbags
- Occupant sensors
- Fuel pressure controls

Enabling Features of the dsPIC30F:

- DSP capability
- Powerful MCU core
- CAN and OSEK Library
- 18- to 80-pin products
- One or two CAN 2.0B modules
- Long product life cycle supported
- Broad product selection for many applications
- Extended temperature operation
- V_{DD} range of +2.5 to 5.5V DC
- LIN support through UART and software
- Safe mode operation features: LVD, BOR, WDT, software traps
- High reliability Flash with typical endurance of one million erase/write cycles and data retention of >40 years

Speech

Often speech and low fidelity audio applications use a DSP for algorithm processing and an MCU for control. The dsPIC30F can replace both in many applications and reduce total system cost. The dsPIC DSC provides enough MIPS for many speech and audio applications, such as noise and echo cancellation, speech recognition and quality speech compression and playback.

The dsPIC DSC is also an ideal companion to a main DSP in high-end audio applications; offloading functions such as a digital tuner, satellite radio, equalizer, etc.

Applications:

- Intercom systems
- High quality speech playback
- Distributed speaker network
- Musical instrument effects
- Voice activated and wireless microphones
- Teleconferencing equipment
- Noise cancelling headsets
- Cabin noise cancellation
- Speech recognition
- Speakerphones
- Hands-free kit
- Answering machines
- Digital two-way radios
- Voice recorders

Enabling Features of the dsPIC30F:

- Codec interface: AC97 and I²S
- 12-bit, 200 ksps A/D converter
- Small footprint package options
- Reduced total system cost
- Reduced board space
- Digital Filter Design tool
- Ready to use DSP Library
- Noise Suppression Library
- Acoustic Echo Cancellation Library
- Speech Encoding/Decoding Library
- Speech Recognition Application Library

Power Conversion and Monitoring

The dsPIC30F is ideal for a variety of power conversion and monitoring applications. UPSs, inverters, as well as power management units within complex equipment, such as copiers, telecom switches and routers, require advanced power management. The dsPIC30F has Pulse Width Modulation (PWM) outputs, fast analog-to-digital conversion and plenty of computation power to satisfy the needs of these applications.

Applications:

- Power and environment monitor in servers
- Power management for equipment
- Circuit breakers
- Arc fault detection
- Auxiliary power unit
- Electric vehicles
- AC to DC converters
- DC to DC converters
- Power factor correction
- Inverters
- Online UPS
- Welding machines

Enabling Features of the dsPIC30F:

- 10-bit, 1 Msps A/D converter
- 2 or 4 simultaneous A/D samples
- A/D sampling synchronized to PWM cycle
- 6 or 8 PWM output
- Complementary or independent PWM
- Center-aligned or edge-aligned PWM
- 1 or 2 fault pins
- 58.6 kHz PWM frequency at 10-bit resolution
- Up to 2 programmable dead time settings
- 28-, 40-, 64- and 80-pin variants
- 5V native operation for noisy environments

Powerful Tools and Libraries to Ease Your Development

The dsPIC30F family comes with an extensive array of development tools, application libraries (many of which are free of charge), development boards and reference designs that allow high-performance embedded solutions to be designed effortlessly and rapidly.

MPLAB® Integrated Development Environment (IDE)

All dsPIC30F tools operate effortlessly under the MPLAB IDE umbrella. The powerful and yet easy-to-use MPLAB IDE has all of the advanced edit/build/debug features you would expect from a 32-bit debug environment. MPLAB IDE integrates not only software, but all of Microchip's hardware tools and many third party tools. Key features of MPLAB IDE:

- Designed for Windows® XP, 2000 and Windows NT®
- Project build and management
- Flexible watch windows
- Mouse over variable inspection
- Full feature code editor with color context
- Source level debug in ASM and C
- Searchable trace buffers
- Version control integration

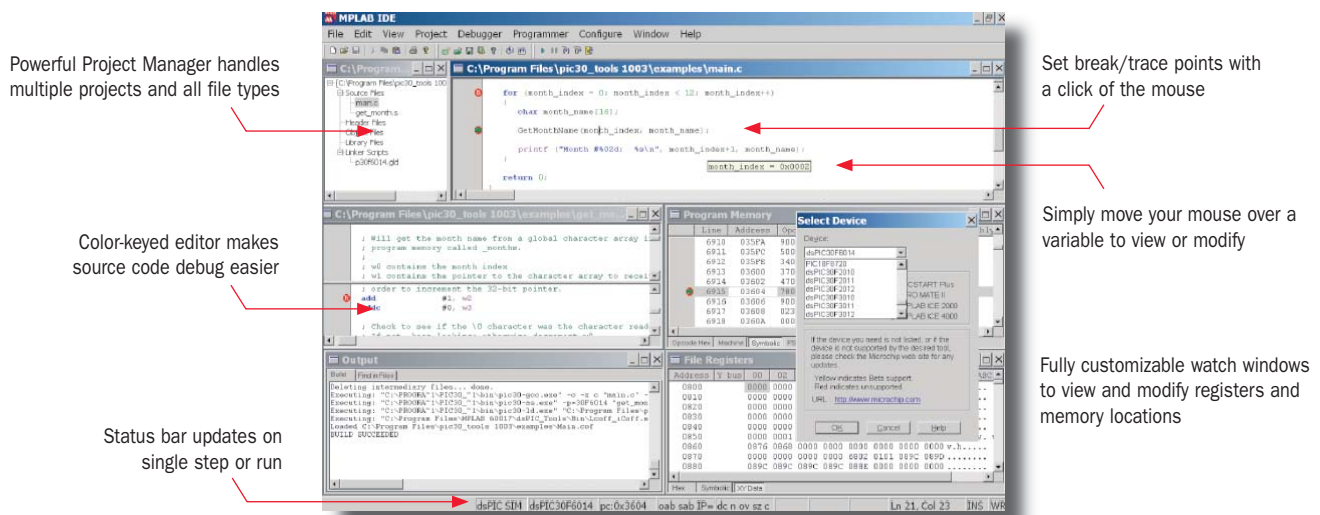

The Essential Software and Hardware Development Tools

Microchip is committed to making your development as easy and efficient as possible. This commitment is the reason why Microchip develops its own software and hardware tools. You have our full technical support whether the issue is silicon or tools-related.

The dsPIC30F development tools suite provides value with many free and low-cost tools. You can get started with the MPLAB ICD 2 In-Circuit Debugger and the MPLAB IDE for approximately US \$160.

If you already own a PRO MATE® II, the dsPIC30F family is supported on it. If you are considering a new full-featured programmer, the MPLAB PM3 is recommended.

MPLAB® IDE	Integrated Development Environment
MPLAB® ASM30	Assembler*
MPLAB® SIM	Software Simulator*
MPLAB® C30	ANSI C Compiler
MPLAB® ICD 2	In-Circuit Debugger/Development Programmer
MPLAB® ICE 4000	In-Circuit Emulator
MPLAB® PRO MATE® II	Full Featured Device Programmer
MPLAB® PM3	Full Featured Device Programmer
MPLAB® VDI	Visual Device Initializer*

*Comes with no-cost MPLAB® IDE

Develop DSP Algorithms: The Easy Way



dsPICworks™ Data Analysis and DSP Software

The dsPICworks Data Analysis and DSP Software makes it easy to evaluate and analyze DSP algorithms. You can run a variety of DSP and arithmetic operations and analyze your data in both time and frequency domain. Key features of the dsPICworks Data Analysis and DSP Software:

- Visually analyze time and frequency domain data
- DSP operations: FFT, convolution, correlation, DCT and filtering
- Waveform synthesis
- Tool generates one-, two- and three-dimensional frequency graphs
- Data import/export options to interface with MPLAB IDE and MPLAB ASM30
- Support for fractional, integer and IEEE floating point data in decimal and hexadecimal notation

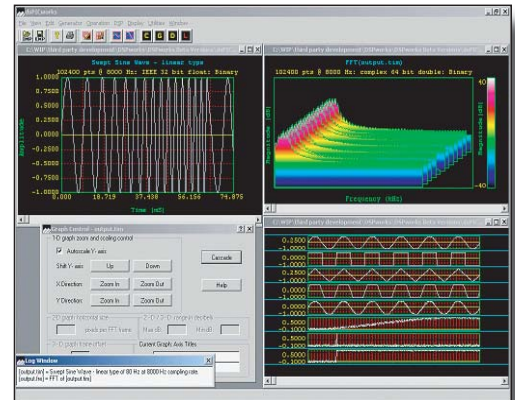

Digital Filter Design Tool

The Digital Filter Design Tool makes designing and analyzing FIR and IIR filters easy. Enter frequency specifications and filter code and coefficients are generated automatically. Graphical output windows provide the desired filter's characteristics.

Digital Filter Design Lite Tool

Not ready to purchase the whole Digital Filter package? Why not start Lite? The Digital Filter Design Lite Tool includes most of the features of the full-featured version at a fraction of the cost.

	Filter Design	Filter Design Lite
List Price	\$249	\$29
Low-pass	✓	✓
High-pass	✓	✓
Band-pass	✓	✓
Band-stop	✓	✓
FIR Taps	Up to 513	Up to 64
IIR Taps for LP, HP	Up to 10	Up to 4
IIR Taps for BP, BS	Up to 20	Up to 8
Generate ASM Code	✓	✓
Export to MPLAB® IDE	✓	✓
Export to MPLAB® C30 C Compiler	✓	✓
MATLAB® Support	✓	—

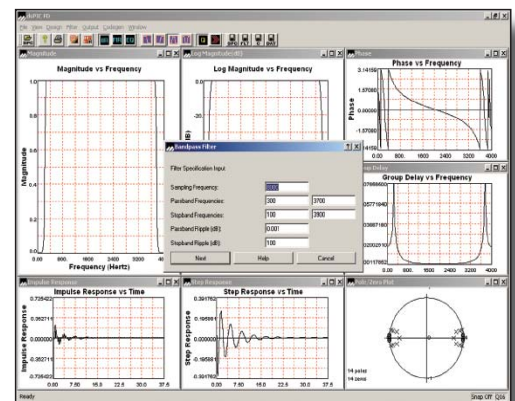

Jump-start Your Design with Proven and Optimized Building Block Libraries



Math Library

This IEEE-754 compliant library provides single and double precision floating point ANSI C standard math functions. These routines have been optimized to provide the smallest code size. The library can be used in Assembly or C. Key functions in the Math Library:

- sin, cos, tan
- asin, acos, atan
- ln, log10, sqrt, power
- ceil, floor, mod, frexp



DSP Algorithm Library

This extensive DSP building block library is fully optimized in Assembly code for execution speed. The DSP functions can be used in Assembly or C. Some key algorithms addressed in the DSP Algorithm Library:

- Cascaded IIR filters
- FIR filters and LMS filters
- Correlation, convolution
- FFT and window functions
- Matrix and vector operations



Peripheral Driver Library

This library of over 270 C utility functions helps you set up and operate the hardware peripheral modules in various modes. Functions covered in the Peripheral Driver Library:

- 10-bit and 12-bit A/D converters
- UART, SPI™, I²C™ and codec interface
- Motor Control PWM and QEI
- General purpose timers
- Input capture and output compare

World Class Software Development Tools



Assembler/Linker/Librarian

The MPLAB ASM30 is a full-featured macro assembler. User defined macros, conditional assembly and a variety of assembler directives make the MPLAB ASM30 a powerful code generation tool.

The MPLAB LINK30 and MPLAB LIB30 are Linker and Librarian modules that allow efficient linking, library creation and maintenance.

Industry Leading C Code Efficiency

The dsPIC30F was designed with a robust, full-featured instruction set optimized for C compiler efficiency from the start. Coupled with Microchip's highly optimized MPLAB C30 C Compiler, this combination produces results that fit into a smaller sized on-chip Flash memory.

MPLAB SIM Software Simulator

The MPLAB SIM Software Simulator is a full-featured, cycle accurate software simulator. In addition to simulating the CPU and the instruction set, it also supports key peripherals, such as timers, I/O, interrupts, UART and A/D modules. MPLAB SIM has powerful stimulus capabilities and file I/O. It is ideal for the algorithm development.



MPLAB VDI Visual Device Initializer

Configuring a powerful 16-bit MCU or DSP can be a complex and challenging task, but not with the dsPIC30F devices. Our MPLAB VDI Visual Device Initializer allows you to configure the entire processor graphically and when complete, a mouse click generates initialization code usable in Assembly or C programs.

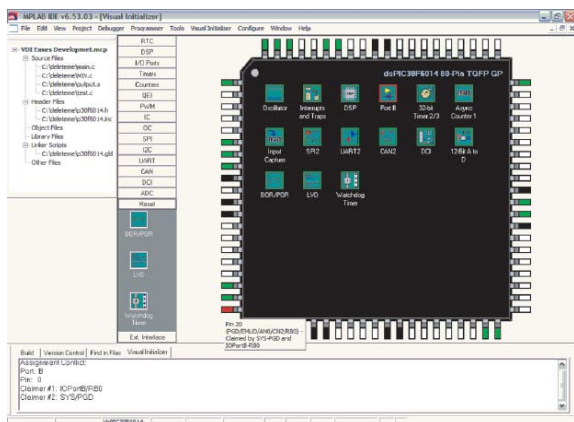

MPLAB C30 C Compiler

The MPLAB C30 C Compiler is a full-featured, ANSI compliant optimizing compiler. The MPLAB C30 C Compiler includes a complete ANSI C standard library, including string manipulation, dynamic memory allocation, data conversion, timekeeping and math libraries.

The MPLAB C30 C Compiler has a powerful code optimizer; other 16-bit MCUs generate as much as 165 percent larger code for the same application.

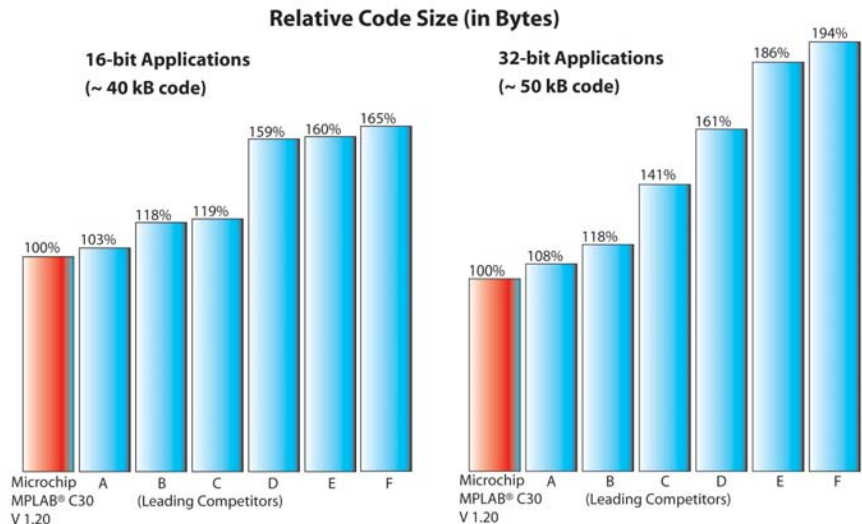

Download a full-featured, time-restricted demonstration version of the MPLAB C30 C Compiler from the Microchip web site for your evaluation.

The MPLAB VDI Visual Device Initializer does extensive error checking on assignments and conflicts on pins, memories and interrupts, as well as a selection of operating conditions. The generated code files are effortlessly integrated with the rest of your application code through MPLAB project manager.

The detailed reports on resource assignment and configuration simplify project documentation. Key features of the MPLAB VDI Visual Device Initializer:

- Drag-and-drop feature selection
- One click configuration
- Extensive error checking
- Generates initialization code
- Integrates effortlessly in MPLAB project manager
- Printed reports ease project documentation requirements

Plug and Play with Our Connectivity Libraries

TCP/IP Protocol Stack

MicroNet™ TCP/IP Stack by CMX

Connect to the Internet using proven, professional quality TCP/IP software libraries. CMX-MicroNet™ is an embedded TCP/IP stack that is specifically designed for optimized use of Flash and RAM resources on Microchip's dsPIC30F. The software runs directly on the processor with no gateways or PCs required. The stack can be run in stand alone mode or work in conjunction with an RTOS. Using only industry standard protocols, CMX-MicroNet offers true TCP/IP networking via direct, dial-up or Ethernet connectivity and wireless Ethernet (802.11b) as well.

Up to 127 sockets can be open at a time. They can be Ethernet sockets and/or PPP or SLIP sockets. PPP and SLIP cannot be used at the same time. An HTTP web server, FTP server, SMTP client and DHCP client are also available. The RS-232 link, if used, can either be a direct cable link or through a modem. This library can be readily implemented on the dsPICDEM.net™ Connectivity Board.

MicroNet™ TCP/IP Stack by CMX

- RFC compliant protocol stack
- Supports CMX RTOS
- Ethernet NIC driver
- Small Flash/RAM footprint
- Source code provided



Microchip Free TCP/IP Stack

The Microchip TCP/IP Stack is now supported on the dsPIC30F product family. This stack is a suite of programs that provide services for standard TCP/IP-based applications (HTTP Server, Mail Client, etc.) or it can be used in a custom TCP/IP-based application. Potential users do not need to know all of the intricacies of the TCP/IP specifications to use it, and those interested only in the accompanying HTTP Server application need not have specific knowledge of TCP/IP. This stack is implemented in a modular fashion, with all of its services creating highly abstracted layers, each layer accessing services from one or more layers directly below it. The stack is optimized for size and is designed to run on the dsPIC DSC. While this particular implementation is specifically targeted to run on the dsPICDEM.net Connectivity Development Board, it can be easily retargeted to any hardware equipped with a dsPIC30F device. HTML web pages generated by the dsPIC DSC can be viewed with a standard web browser such as Microsoft® Internet Explorer.

Microchip Free TCP/IP Stack

- Out-of-box support for Microchip C30 compilers
- Utilizes the dsPICDEM Connectivity Development Board
- Implements complete TCP state machine
- Multiple TCP and UDP sockets with simultaneous connection/management
- Modules provided: MAC, SLIP, ARP, IP, ICMP, TCP, SNMP, UDP, DHCP, FTP, IP Gleaning, HTTP, MPFS (Microchip File System)
- Use it as a part of HTTP Server (included) or any custom TCP/IP based application
- RTOS independent

Soft Modem Libraries



V.22bis/V.22 Soft Modem Library

This library is available free of charge from the Microchip web site. The V.22bis Soft Modem Library is a collection of algorithms for ITU-T compliant V.21/Bell 103, V.22 and V.22bis modems and V.42 recommendations. The V.22bis library comes with full source code and archives that contain object code modules required for linking with your application. The transmit and receive data pump code modules are coded in Assembly language for optimal speed and smallest code size, while the AT, V.42 and Data Pump APIs are coded in C. Hardware component drivers, such as UART and Data Converter Interface (DCI) for Analog Front End (AFE) I/O are provided. This library can be readily implemented on the dsPICDEM.net Connectivity Board.

V.32bis/V.22bis by Microchip

- Data Pump coded In Assembly for optimal size and speed
- V.32bis (14,400 thru 4800 bps)
- V.22bis (2400/1200 bps)
- V.42 (LAPM, error correction procedure)

V.32bis Soft Modem Library

The V.32bis Soft Modem Library is a collection of algorithms for ITU-T compliant V.21/Bell 103, V.22, V.22bis, V.32 and V.32bis modems and V.42 recommendations. The V.32bis library is provided with archives that contain object code modules required for linking with your application. The transmit and receive data pump code modules are coded in Assembly language for optimal speed and smallest code size, while the AT, V.42 and Data Pump APIs are coded in C. Hardware component drivers, such as UART and DCI for AFE I/O are provided. This library can be readily implemented on the dsPICDEM.net Connectivity Board.

V.32/V.22/V.22bis by VOCAL Technologies, LTD

- VOCAL's proven solution on a dsPIC30F
- V.32 (9600 and 4800 bps, non-trellis encoding)
- V.22/V.22bis (2400, 1200 and 600 bps)
- V.42 (LAPM, error correction procedure)

V.32/V.22/V.22bis Soft Modem Library by VOCAL Technologies, LTD

The Soft Modem Library is a collection of data modulations and protocols (V.32, V.22, V.22bis, V.23, V.21, Bell 103, Bell 212A and Bell 202). This library is provided with archives that contain object code modules, which link to your application. The data modulation is coded in C with inline Assembly language optimization for speed and code size. Hardware component drivers, such as UART and DCI for AFE I/O are provided. This library can be readily implemented on the dsPICDEM.net Connectivity Board.

Libraries for Speech Applications

Noise Suppression Library

This application library suppresses the noise interference in a speech signal, such as ambient noise picked up by a microphone while capturing speech. This algorithm is particularly useful for systems where isolated noise reference is not available—such as hands-free phones, speakerphones, intercoms and headsets.

The library is written in Assembly language for maximum optimization of code size and execution speed. It can be easily integrated in C or Assembly code. The algorithm handles 0-4 kHz audio bandwidth (8 kHz sampling of 16-bit speech data) and provides 10-20 dB noise reduction. The library also includes some sample rate conversion functions to support input/output sampling rates of 9.6 kHz, 11.025 kHz and 12 kHz.

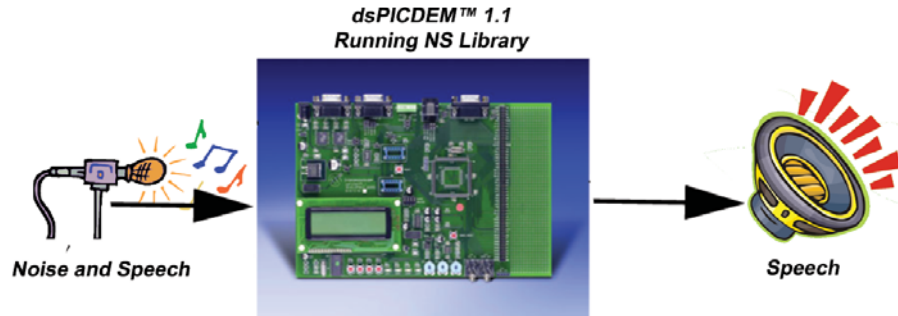

Acoustic Echo Cancellation Library

This library provides a function to eliminate the echo generated in the acoustic path between a speaker and a microphone, such as in a speakerphone or an intercom system.

This library is fully compliant with the G.167 standard, supports cancellation and provides 16, 32 or 64 ms echo delays. It handles 0-4 kHz audio bandwidth (8 kHz sampling of 16-bit speech data) and provides echo cancellation of 40-50 dB. Written in Assembly language for optimal code size and execution speed, this library can be easily integrated in C or Assembly code. The library also includes some sample rate conversion functions to support input/output sampling rates of 9.6 kHz, 11.025 kHz and 12 kHz.

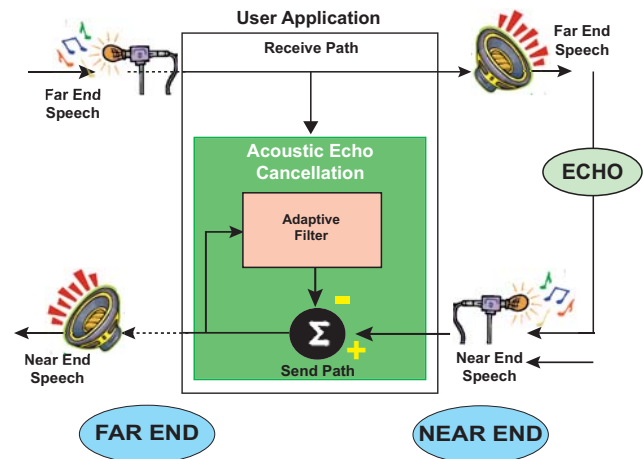

Speech Encoding/Decoding Library

This application library performs speech compression and decompression and is based on a modified open-source Speex technology. The library features a 16:1 compression ratio and an 8 kbps data rate. This makes the library a good choice for digital voice communication, store-and-playback and playback-only applications. For playback-only applications, a PC software utility is included which allows the designer to create encoded speech files for playback. The input source may be either a microphone or WAV file.

Speech Encoding/Decoding Library features:

- 8 kHz input sample rate; 8 kbps output data rate
- Sorting encoded speech requires 4 Kbytes
- Optional voice activity detection
- External Flash support for playing back large speech files
- Royalty-free, one time license fee

Speech Recognition

Automatic Speech Recognition (ASR) for the dsPIC30F family can support a wide range of voice-activated applications such as handset and home appliance control. A Speech Word Library Builder and a Speech Recognition Software Library make up the ASR software suite. Key features of the ASR application software:

Speech Recognition Library features:

- Speaker independent recognition
- PC-based word library builder
- Up to 100 word vocabulary (American English)
- Supports multiple noise profiles
- Suitable for many voice control applications

More Application Libraries Ready to Use

Encryption Libraries

Implement reliable secure applications using the Symmetric and Asymmetric Key Embedded Encryption Libraries. Developed for Microchip by NTRU Cryptosystems Inc., a leader in encryption solutions, these libraries are both proven and optimized. These library functions can be easily called by your C or Assembly code.

The algorithms included in these libraries have emerged as de facto standards for many large scale secure applications such as web access (SSL/TLS), E-mail (S-MIME), secure XML transactions and virtual private networks (IPsec). These algorithms are also recommended by Federal Information Processing Standards (FIPS) and the Internet Engineering Task Force (IETF).

Symmetric Key Embedded Encryption Library features:

- 128-bit AES in ECB, CTR, CBC, CBC-MAC and CCM modes
- Triple DES in ECB, CTR, CBC and CBC-MAC modes
- SHA-1
- MD5
- Random number generator (DRBG X9.82)

Asymmetric Key Embedded Encryption Library features:

- RSA (1024-bit and 2048-bit modulus)
 - Encryption/decryption
 - Signing/verification
- DSA (1024-bit modulus)
 - Private/public key generation
 - Signing/verification
- Diffie-Hellman Key Agreement (1024-bit and 2048-bit modulus)
 - Private/public key generation
 - Shared-key generation
- SHA-1
- MD5
- Random number generator (DRBG X9.82)

\$5 Evaluation License for Evaluation and Development

A common issue with software libraries is that in order to evaluate the complete library, you must enter into a complex and expensive license arrangement. Any Microchip dsPIC DSC library can be licensed for \$5.00 for evaluation and development purposes. These libraries are complete and unchanged from the production libraries, not reduced function evaluation versions. Evaluation licenses are available from the Microchip web site (<http://buy.microchip.com>). Licenses for production are based on a simple low cost one-time license fee. Production licenses are available from Microchip or from our authorized distributors.

Motor Control Application Software

The dsPIC30F motor control family of devices is suited for advanced AC Induction Motor (ACIM), Brushless DC (BLDC) and Switched Reluctance (SR) motor applications. Two advanced applications are currently available that run on the dsPIC30F Motor Control Development System.

Vector Control of an ACIM

This application note describes a fully-tested vector, or field oriented, control algorithm for a 3-phase ACIM. The motor currents, torque and velocity are regulated in control loops. Full documentation and source code are available for free on the Microchip web site (Application Note: AN908).

Sensorless BLDC Control

This application note describes a fully-tested sensorless control algorithm for a 3-phase BLDC motor. Motor current, motor velocity and bus voltage are regulated in control loops. A LCD menu interface provides adjustment of all sensorless motor control parameters. Full documentation and source code are available for free on the Microchip web site (Application Note: AN901).

Sensored BLDC Motor Control

This application note describes a fully-tested 3-phase BLDC motor control algorithm with 3 hall-effect sensors. Code is available with and without a PI speed control loop. Full documentation and source code are available for free on the Microchip web site (Application Note: AN957).

Introduction of ACIM Control

This application note is an introductory approach to the methods described in Application Note: AN908. Code is provided in an example that provides basic variable speed control of a single or three-phase ACIM. Full documentation and source code are available for free on the Microchip web site (Application Note: AN984).

Operating Systems and Communication Drivers

RTOS

If you need a Real-Time Operating System (RTOS) to handle multitasking, we have a three-tier solution for you.



- CMX-RTX™: full-featured fully preemptive multi-tasking OS
- CMX-Tiny+™: fully preemptive scaled-down version of the RTX OS
- CMX-Scheduler™: fully preemptive multi-tasking mini OS (FREE)

All three operating systems are fully preemptive and written in Assembly language optimized for maximum performance. These RTOS products are developed by CMX and available from Microchip and CMX.

RTOS features:

- Small program memory footprints
- The fastest context switch times
- The lowest interrupt latency times
- True Preemption

OSEK and CAN Drivers

Vector Informatik GmbH provides automotive operating systems, sometimes labeled as an OSEK operating system. The Vector Informatik osCAN operating system, which is based on the OSEK/VDX® standard, provides a multitasking operating system with optimal features for use on MCUs. This product represents a small, sturdy operating system kernel.

The companion support for managing the CAN interface drivers on the dsPIC30F family of products is the CANbedded CAN driver suite from Vector Informatik. This product consists of a number of adaptive source code modules that cover the basic communication requirements in automotive applications.

Some of the CAN functions supported:

- Initialize CAN Module
- Set CAN Operational Mode
- Set CAN Baud Rate
- Set CAN Mask
- Set CAN Filter
- Send CAN Message
- Receive CAN Message
- Abort CAN Sequence
- Random Number Generator
- Provide Error Notification

Online Resources for Self-paced Learning

Microchip offers extensive online resources for designers ranging from downloadable documentation to web seminars (webinars) to online discussion groups. All of these helpful resources are accessible on www.microchip.com/webseminars and are updated frequently with the most current information on our products and services.

Webinar Topic	Duration
Introduction to the dsPIC® Digital Signal Controller	20 min
Introduction to Microchip's Development Tools	25 min
Introduction to dsPIC30F Architecture - Part 1	20 min
Introduction to dsPIC30F Architecture - Part 2	20 min
Introduction to MPLAB® IDE Integrated Development Environment	25 min
Basic dsPIC30F Development Tools	25 min
dsPIC30F Addressing Modes - Part 1	20 min
dsPIC30F Addressing Modes - Part 2	20 min
Introduction to dsPIC30F DSP Engine and ALU	30 min
Introduction to dsPIC30F Interrupts	25 min
dsPIC30F 12-bit ADC Module - Part 1	20 min
dsPIC30F 12-bit ADC Module - Part 2	20 min
dsPIC30F 10-bit ADC Module - Part 1	20 min
dsPIC30F 10-bit ADC Module - Part 2	20 min
Introduction to the MPLAB® VDI Visual Device Initializer	30 min
Serial Communications using the dsPIC30F - Part 1 (UART)	20 min
Serial Communications using the dsPIC30F - Part 2 (SPI™)	20 min
Serial Communications using the dsPIC30F - Part 3 (I²C™)	30 min
Serial Communications using the dsPIC30F - Part 4 (CAN)	30 min
General Purpose Timers	20 min
dsPIC30F Motor Control Peripherals - Part 1 (MCPWM)	20 min
dsPIC30F Motor Control Peripherals - Part 2 (QEI)	20 min

To watch an archived Webinar, you need:

- Windows Media Player v6 or higher sound card

Notes:

- Unzipped media files are large approximately 20 to 50 MB each
- Performance of media files may be affected by type of video card, amount of system RAM and CPU speed

Hardware Development Tools

MPLAB ICD 2 In-Circuit Debugger

The MPLAB ICD 2 In-Circuit Debugger is a powerful, low-cost development tool. Running under MPLAB IDE, MPLAB ICD 2 can debug ASM or C source code, watch and modify variables, single step and set breakpoints. Key features of the MPLAB ICD 2:

- Full speed operation
- USB or serial port connection to PC
- Supports full dsPIC DSC supply voltage range
- Can be used as an inexpensive programmer
- Smart watch variable windows
- Advanced breakpoint features



MPLAB PM3 Device Programmer

MPLAB PM3 Device Programmer is a full-featured, production quality universal device programmer. Using interchangeable socket modules, the MPLAB PM3 supports virtually all programmable devices from Microchip. MPLAB PM3 has improved programming time for many devices and offers built-in interface for robust In-Circuit Serial Programming™ (ICSP™).

If you already own a PRO MATE® II Device Programmer, the dsPIC30F family is supported on the PRO MATE II Device Programmer through a new set of socket modules.

MPLAB ICE 4000 In-Circuit Emulator

The powerful, full-featured real-time MPLAB ICE 4000 In-Circuit Emulator is capable of debugging the most demanding real-time systems. Key features of the MPLAB ICE 4000 In-Circuit Emulator:

- Full-speed, real-time emulation
- Supports full dsPIC DSC supply voltage range
- 64K deep by 216-bit wide trace memory
- Unlimited breakpoints
- Complex break, trace and trigger logic
- Multi-level trigger up to four levels
- 48-bit time stamp
- USB connection to PC
- Stopwatch



Hardware Development Boards: Jump-start Your Design

A variety of hardware development boards are available for the dsPIC30F, enabling you to shorten your design cycle. These boards are designed to allow easy plug-in of an MPLAB ICD 2 or an MPLAB ICE 4000 emulator.

dsPICDEM™ Starter Development Board

This Development Board offers a very economical way to evaluate the dsPIC30F General Purpose Family devices. Key features of the dsPICDEM Starter Development Board:

- Includes a 64-pin dsPIC30F6012 plug-in module (MA300012)
- Power input from 9V supply
- LEDs, switches, potentiometer, UART interface
- A/D input filter circuit for speech-band signal input
- On-board DAC and filter for speech-band signal output
- Circuit prototyping area
- Assembly language demonstration program and tutorial

DM300016



dsPICDEM 28-Pin Starter Development Board

This Development Board provides an economical solution to get started with 28-pin dsPIC30F devices, including Motor Control, Sensor and Power Conversion Families. Key features of the dsPICDEM 28-Pin Starter Development Board:

- Includes a 28-pin dsPIC30F2010 device
- Power input from 9V power supply
- UART interface
- Header for access to all device I/O pins
- Circuit prototyping area
- Assembly language demonstration program and tutorial
- Accommodates all dsPIC30F 28-pin devices

DM300017

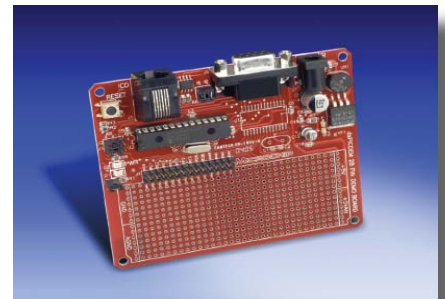

Advanced Development Boards: Complex Designs Made Simple

dsPICDEM 1.1 General Purpose Development Board

Key features of the dsPICDEM General Purpose Development Board are:

- Includes a dsPIC30F6014 plug-in module (MA300011)
- Serial communication channels (two UART, SPI, CAN)
- Si3000 codec with MIC IN/speaker OUT
- General purpose prototyping area and expansion header
- 122 x 32 dot addressable LCD
- Digital potentiometer for DAC capability
- LEDs, switches, potentiometers and temperature sensor
- MPLAB ICD 2 and MPLAB ICE 4000 emulator support

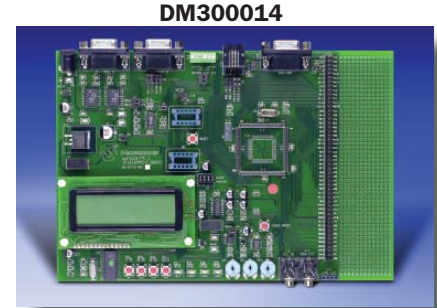

dsPICDEM.net™ Connectivity Development Boards

Key features of the dsPICDEM.net Connectivity Development Boards are:

- Includes a dsPIC30F6014 plug-in module (MA300011)
- 10-Base T Ethernet MAC and PHY interface
- PSTN interface with DAA/AFE chipset
- Serial communication channels (UART and CAN)
- External EEPROM memory for storing constants
- External 64K x 16 SRAM memory
- General purpose prototyping area and expansion header
- LEDs, switches, potentiometers and temperature sensor
- 2 x 16 LCD display
- MPLAB ICD 2 and MPLAB ICE 4000 emulator support
- dsPICDEM.net 1 (DM300004-1)
 - Support for FCC/JATE PSTN countries
- dsPICDEM.net 2 (DM300004-2)
 - Support for CTR-21 PSTN countries



Motor Control Development System

The Motor Control Development System provides you with a method for quick prototyping and validation of BLDC, SR, PMAC, ACIM and UPS applications. The system consists of the dsPICDEM MC1 Motor Control Development Board and one of two optional power modules. The dsPICDEM MC1H 3-Phase High-Voltage Power Module (DM300021) supports AC line-powered applications, while the dsPICDEM MC1L 3-Phase Low-Voltage Power Module (DM300022) supports DC-powered applications up to 48V. Some key features of the Motor Control Development System:

- Heat sink for ambient cooling of power sections
- Full automatic protection of power circuits
- Electrical isolation from power circuits
- Many options for motor feedback signals
- MPLAB ICD 2 and MPLAB ICE 4000 emulator support



Note: Power module shown with dsPICDEM MC1 Development Board DM300020



Includes a dsPIC30F6010 plug-in module (MA300013)

Software Development Tools

Development Tool	Product Name	Description	Part#	Available From	List Price ⁽¹⁾
Software	MPLAB® IDE	Integrated Development Environment	SW007002	Microchip	Free
	MPLAB® ASM30	Assembler (included in MPLAB® IDE)	SW007002	Microchip	Free
	MPLAB® SIM	Software Simulator (included in MPLAB® IDE)	SW007002	Microchip	Free
	MPLAB® VDI	Visual Device Initializer for dsPIC30F (included in MPLAB® IDE)	SW007002	Microchip	Free
C Compilers	MPLAB® C30	ANSI C Compiler, Assembler, Linker and Librarian	SW006012	Microchip	\$895
	Embedded Workbench for dsPIC30F	ISO/ANSI C and Embedded C++ compiler in a professional, extensible IDE (Windows® NT/2000/Windows XP®) Special DSP support included.	EWdsPIC 1	IAR	Contact Vendor
	C compiler	ANSI C compiler for dsPIC30F	dsPICC	HI-TECH	\$950

Hardware Development Tools

Development Tool	Description	Part#	Available From	List Price ⁽¹⁾
MPLAB® ICD 2	In-Circuit Debugger and Device Programmer	DV164005	Microchip	\$159
	In-Circuit Debugger and Device Programmer with dsPICDEM™ Starter Demo Board	DV164030	Microchip	\$209
	In-Circuit Debugger and Device Programmer with dsPICDEM™ 1.1 General Purpose Board	DV164032	Microchip	\$399
MPLAB® ICE 4000	In-Circuit Emulator Pod	ICE4000	Microchip	\$2560
	Processor Module for dsPIC30F	PMF30XA1	Microchip	\$595
	Device Adapter for 80L/64L TQFP Devices	DAF30-2	Microchip	\$295
	Device Adapter for 44L TQFP Devices	DAF30-3	Microchip	\$225
	Device Adapter for 44L/40L/28L/18L DIP and SOIC Devices (ML and MM)	DAF30-4	Microchip	\$225
	Transition Socket for 18L SOIC	XLT18S0	Microchip	\$75
	Transition Socket for 18L DIP	ACICE0202	Microchip	\$20
	Transition Socket for 28L SOIC	XLT28S0	Microchip	\$75
	Transition Socket for 28L DIP	ACICE0204	Microchip	\$30
	Transition Socket for 28L ML/MM	XLT28QFN3 or XLT28QFN4	Microchip	\$175
	Transition Socket for 40L DIP	ACICE0206	Microchip	\$40
	Transition Socket for 44L ML	XLT44QFN2	Microchip	\$175
	Transition Socket for 44L TQFP	XLT44PT or XLT44PT3	Microchip	\$125
	Transition Socket for 64L TQFP (PF Package)	XLT64PT3 or XLT64PT4	Microchip	\$125
	Transition Socket for 64L TQFP (PT Package)	XLT64PT2 or XLT64PT5	Microchip	\$125
	Transition Socket for 80L TQFP (PF Package)	XLT80PT2	Microchip	\$125
	Transition Socket for 80L TQFP (PT Package)	XLT80PT or XLT80PT3	Microchip	\$125
MPLAB® PRO MATE® II	Full Featured Device Programmer, Base Unit	DV007003	Microchip	\$695
	Socket Module for 18L DIP/SOIC Devices	AC30F005	Microchip	\$189
	Socket Module for 28L DIP/SOIC Devices	AC30F004	Microchip	\$189
	Socket Module for 40L DIP Devices	AC30F003	Microchip	\$159
	Socket Module for 44L TQFP Devices	AC30F006	Microchip	\$159
	Socket Module for 64L TQFP Devices (PF Package)	AC30F002	Microchip	\$159
	Socket Module for 64L TQFP Devices (PT Package)	AC30F008	Microchip	\$159
	Socket Module for 80L TQFP Devices (PF Package)	AC30F001	Microchip	\$159
MPLAB® PM3	Socket Module for 80L TQFP Devices (PT Package)	AC30F007	Microchip	\$159
	Full Featured Device Programmer, Base Unit	DV007004	Microchip	\$895
	Socket Module for 18L/28L/40L DIP Devices	AC164301	Microchip	\$189
	Socket Module for 16L(.150)/28L(.300) SOIC Devices	AC164302	Microchip	\$189
	Socket Module for 28L ML Devices	AC164322	Microchip	\$189
	Socket Module for 44L ML Devices	AC1643	Microchip	\$189
	Socket Module for 44L TQFP Devices	AC164305	Microchip	\$189
	Socket Module for 64L TQFP Devices (PF Package)	AC164313	Microchip	\$189
	Socket Module for 64L TQFP Devices (PT Package)	AC164319	Microchip	\$189
	Socket Module for 80L TQFP Devices (PF Package)	AC164314	Microchip	\$189
Socket Module for 80L TQFP Devices (PT Package)	AC164320	Microchip	\$189	

Development Boards and Reference Designs

Development Tool	Description	Part#	Available From	List Price ⁽¹⁾
General Purpose Development Board	dsPICDEM™ 1.1 Development Board for 80L TQFP devices	DM300014	Microchip	\$299
Starter Development Boards	dsPICDEM™ 64-pin Starter Development Board	DM300016	Microchip	\$79
	dsPICDEM™ 28-pin Starter Development Board	DM300017	Microchip	\$79
Motor Control Development Boards	dsPICDEM™ MC1 Motor Control Development Board	DM300020	Microchip	\$300
	dsPICDEM™ MC1H 3-Phase High Voltage Power Module	DM300021	Microchip	\$800
	3-Phase ACIM High Voltage Motor (208/460V)	AC300021	Microchip	\$120
	dsPICDEM™ MC1L 3-Phase Low Voltage Power Module	DM300022	Microchip	\$700
Connectivity Development Boards	3-Phase BLDC Low Voltage Motor (24V)	AC300020	Microchip	\$120
	dsPICDEM.net™ 1 with FCC/JATE-compliant and Ethernet NIC support	DM300004-1	Microchip	\$389
	dsPICDEM.net™ 2 with CTR-21-compliant and Ethernet NIC support	DM300004-2	Microchip	\$389

Plug-in Modules for Development Boards

A Plug-in Module (PIM) is a daughter board with a dsPIC30F device soldered on top and header socket strips on the bottom. The PIMs use the device header pins, on the dsPIC DSC development boards, which also support the MPLAB ICE 4000 emulator device adapters. This method allows for easy swapping of devices onto the various development boards, without having to unsolder and resolder parts.

Development Tool	Description	Part#	Available From	List Price ⁽¹⁾
Plug-in Modules	PC board with 80-pin dsPIC30F6014 general purpose MCU sample; use with DM300004-1, DM300004-2 and DM30014 Development Boards	MA300011	Microchip	\$25
	PC board with 64-pin dsPIC30F6012 general purpose MCU sample; use with DM300016 Development Board	MA300012	Microchip	\$25
	PC board with 80-pin dsPIC30F6010 motor control MCU sample; use with DM300020 Development Board	MA300013	Microchip	\$25

⁽¹⁾ List price may change without notice.

Software Libraries and Application Development Tools

Development Tool	Description	Part#	Available From	List Price ⁽¹⁾
dsPIC30F Math Library	Basic and Floating Point Library (ASM, C Wrapper)	SW300020	Microchip	Free
dsPIC30F Peripheral Library	Peripheral Initialization, Control and Utility Routines (C)	SW300021	Microchip	Free
dsPIC30F DSP Library	Essential DSP algorithm suite (Filters, FFT)	SW300022	Microchip	Free
dsPICworks™	Data Analysis and DSP Software	SW300023	Microchip	Free
Digital Filter Design	Graphical IIR and FIR filter design package for dsPIC30F	SW300001	Microchip	\$249
Digital Filter Design Lite	Graphical IIR and FIR filter design package for dsPIC30F	SW300001-LT	Microchip	\$29
CMX-Tiny+™ for dsPIC® DSC	Preemptive Real-time Operating System (RTOS) for dsPIC30F (from CMX)	CMX-Tiny+ for dsPIC30F	CMX	\$3000
	Preemptive Real-time Operating System (RTOS) for dsPIC30F	SW300032	Microchip	\$3000
CMX-RTX™ for dsPIC® DSC	Fully preemptive Real-time Operating System (RTOS) for dsPIC30F (from CMX)	CMX-RTX for dsPIC30F	CMX	\$4000
	Fully preemptive Real-time Operating System (RTOS) for dsPIC30F	SW300031	Microchip	\$4000
CMX Scheduler™	Multi-tasking, preemptive scheduler for dsPIC30F	SW300030	CMX	Free
Symmetric Key Embedded Encryption Library	Security encryption software support for AES, triple-DES, SHA-1, RNG and MD5	SW300050 - 5K*	Microchip	\$2500
	Evaluation copy of security encryption software support for AES, triple-DES, SHA-1, RNG and MD5	SW300050-EVAL	Microchip	\$5
Asymmetric Key Embedded Encryption Library	Security encryption software support for RSA, DSA, Diffe Hellman, SHA-1, RNG and MD5	SW300055 - 5K*	Microchip	\$2500
	Evaluation copy of security encryption software support for RSA, DSA, Diffe Hellman, SHA-1, RNG and MD5	SW300055-EVAL	Microchip	\$5
Noise Suppression Library	Function to suppress noise interference in speech signals	SW300040 - 5K*	Microchip	\$2500
	Evaluation copy of function to suppress noise interference in speech signals	SW300040-EVAL	Microchip	\$5
Acoustic Echo Cancellation Library	Function to eliminate echo generated from a speaker to a microphone	SW300060 - 5K*	Microchip	\$2500
	Evaluation copy of function to eliminate echo generated from a speaker to a microphone	SW300060-EVAL	Microchip	\$5
Acoustic Accessory Kit	Accessory Kit (includes: audio cable, headset, oscillators, microphone, speaker, DB9 M/F RS-232 cable, DB9M-DB9M Null Modem Adapter)	AC300030	Microchip	\$87.50
TCP/IP Library	TCP/IP connectivity and protocol support	CMX-MicroNet for dsPIC30F	CMX	Contact Vendor
	TCP/IP connectivity and protocol support	SW300024	Microchip	Free
Soft Modem Library	V.22bis/V.22 Soft Modem Library	SW300002	Microchip	Free
	V.32bis Soft Modem Library	SW300003*	Microchip	\$2500
	Evaluation copy of V.32bis Soft Modem Library	SW300003-EVAL	Microchip	\$5
	V.32 (non-trellis) Soft Modem Library		VOCAL Technologies, LTD	Contact Vendor
Speech Recognition System	Automatic speech recognition system including a PC-based speech training sub-system and a speech recognizer software library	SW300010 - 5K*	Microchip	\$2500
	Evaluation copy of automatic speech recognition system including a PC-based speech training sub-system and a speech recognizer software library	SW300010-EVAL	Microchip	\$5
Speech Encoding/Decoding Library	Speech library to preform speech compression and decompression	SW300070 - 5K*	Microchip	\$2500
	Evaluation copy of speech library to preform speech compression and decompression	SW300070-EVAL	Microchip	\$5
CANbedded for dsPIC® DSC	CAN Driver Library for dsPIC30F		Vector Informatik	Contact Vendor
osCAN for dsPIC® DSC	OSEK/VDX v2.2		Vector Informatik	Contact Vendor

(1) List price may change without notice

* To license for production quantities greater than 5000 pieces for a project's lifetime—contact Microchip.

Documentation⁽²⁾

Document Type	Document Title	Document Number
Overview Documents	dsPIC30F High Performance 16-bit Digital Signal Controller Family Overview	DS70043
	dsPIC30F Data Sheet, General Purpose and Sensor Families	DS70083
	dsPIC30F Data Sheet, Motor Control and Power Conversion Family	DS70082
Data Sheets	dsPIC30F2010 Data Sheet	DS70118
	dsPIC30F2011, dsPIC30F2012, dsPIC30F3012, dsPIC30F3013 Data Sheet	DS70139
	dsPIC30F3010, dsPIC30F3011 Data Sheet	DS70141
	dsPIC30F3014, dsPIC30F4013 Data Sheet	DS70138
	dsPIC30F4011, dsPIC30F4012 Data Sheet	DS70135
	dsPIC30F5011, dsPIC30F5013 Data Sheet	DS70116
	dsPIC30F6010 Data Sheet	DS70119
	dsPIC30F6011, dsPIC30F6012, dsPIC30F6013, dsPIC30F6014 Data Sheet	DS70117
	Reference Manuals	dsPIC30F Programmer's Reference Manual
dsPIC30F Family Reference Manual		DS70046
Application Notes	AN901- Using the dsPIC30F for Sensorless BLDC Control	DS00901
	AN908 - Using the dsPIC30F for Vector Control of an AC Induction Motor	DS00908
	AN957 - Sensored BLDC Motor Control Using dsPIC30F2010	DS00957
	AN962 - Implementing Auto Baud on dsPIC30F Devices	DS00962
	AN984 - An Introduction to AC Induction Motor Control Using the dsPIC30F	DS00984
Technical CD	dsPIC30F Technical CD-ROM (contains all of the above)	DS70084

(2) Note that all the latest revisions of these documents are always available from the Microchip web site.

Third Party Contact Information

Company	Phone	E-mail	Web Site
CMX Systems, Inc.	+1 904 880 1840	cmx@cmx.com	www.cmx.com
HI-TECH Software	+61 7 3552 777	hitech@htsoft.com	www.htsoft.com
IAR	+46 18 16 78 00	info@iar.se	www.iar.se
Vector Informatik GmbH	+49 711 80670 0	info@vector-informatik.com	www.vector-informatik.com
VOCAL Technologies, LTD	+1 716 688 4675	sales@vocal.com	www.vocal.com

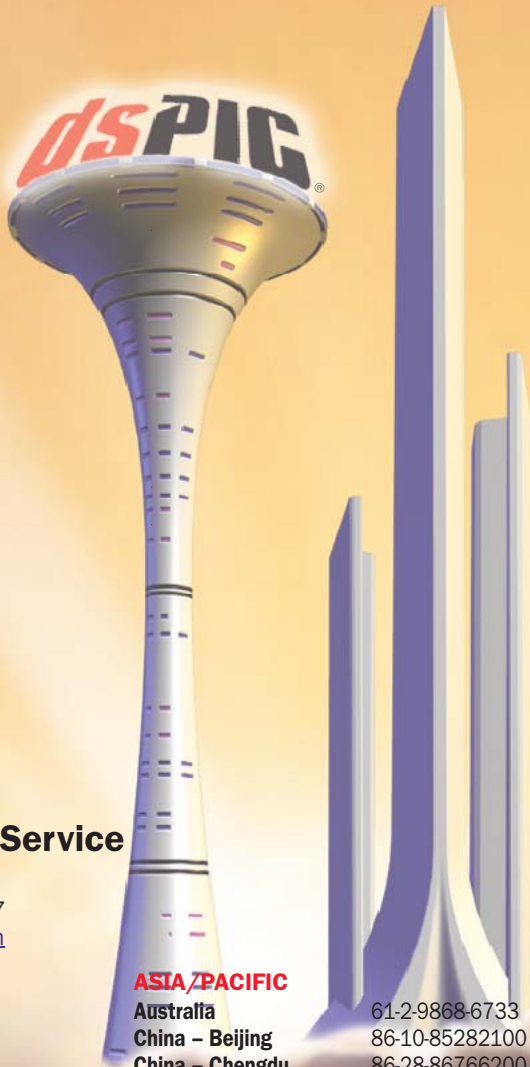

Worldwide Sales and Service

Technical Support: 480-792-7627

Web Address: www.microchip.com

AMERICAS

Atlanta	770-640-0034
Boston	978-692-3848
Chicago	630-285-0071
Dallas	972-818-7423
Detroit	248-538-2250
Kokomo	765-864-8360
Los Angeles	949-263-1888
San Jose	650-215-1444
Toronto	905-673-0699

ASIA/PACIFIC

Australia	61-2-9868-6733
China – Beijing	86-10-85282100
China – Chengdu	86-28-86766200
China – Fuzhou	86-591-7503506
China – Hong Kong	852-2401-1200
China – Shanghai	86-21-6275-5700
China – Shenzhen	86-755-82901380
China – Shunde	86-757-28395507
China – Qingdao	86-532-5027355
India	91-80-22290061
Japan	81-45-471-6166
Korea	82-2-554-7200
Singapore	65-6334-8870
Taiwan	886-2-2717-7175
Taiwan – Kaohsiung	886-7-536-4818

EUROPE

Austria	43-7242-2244-399
Denmark	45 4420 9895
France	33-1-69-53-63-20
Germany	49-89-627-144-0
Italy	39-0331-742611
Netherlands	31-416-69-03-99
United Kingdom	44-118-921-5869



MICROCHIP

www.microchip.com

2355 West Chandler Boulevard • Chandler, AZ 85224-6199

Information subject to change. The Microchip name, the Microchip name and logo, dsPIC, MPLAB and PRO MATE are registered trademarks and ICSP In-Circuit Serial Programming, dsPICDEM, dsPICDEM.net and dsPICworks are trademarks in the U.S.A. and other countries. All other trademarks mentioned herein are property of their respective companies. ©2005 Microchip Technology Inc. All rights reserved.
Printed in the U.S.A. DS70095H 3/05