

# CAT3636

## 6-Channel Fractional LED Driver in TQFN 3x3

### Description

The CAT3636 is a high efficiency fractional charge pump that can drive up to six LEDs programmable by a one wire digital interface. The inclusion of a 1.33x fractional charge pump mode increases device efficiency by up to 10% over traditional 1.5x charge pumps with no added external capacitors.

Low noise input ripple is achieved by operating at a constant switching frequency which allows the use of small external ceramic capacitors. The multi-fractional charge pump supports a wide range of input voltages from 2.5 V to 5.5 V.

The EN/SET logic input functions as a chip enable and a “1-wire” addressable interface for control and current setting of all LEDs. Three groups of two LEDs can be configured with independent LED currents between 0.25 mA and 32 mA.

The device is available in a tiny 16-lead TQFN 3 mm x 3 mm package with a max height of 0.8 mm.

ON Semiconductor’s 1.33x charge pump switching architecture is patented.

### Features

- High Efficiency 1.33x Charge Pump
- Charge Pump: 1x, 1.33x, 1.5x, 2x
- Drives up to 6 LEDs at 32 mA Each
- 1-Wire EZDim LED Current Programming
- Power Efficiency up to 92%
- Low Noise Input Ripple in All Modes
- “Zero” Current Shutdown Mode
- Soft Start and Current Limiting
- Short Circuit Protection
- Thermal Shutdown Protection
- Tiny 3 mm x 3 mm, 16-lead TQFN Package
- These Devices are Pb-Free, Halogen Free/BFR Free and are RoHS Compliant

### Applications

- LCD Display Backlight
- Color RGB LEDs
- Cellular Phones
- Digital Still Cameras
- Handheld Devices



ON Semiconductor®

<http://onsemi.com>



TQFN-16  
HV3 SUFFIX  
CASE 510AD

### PIN CONNECTIONS

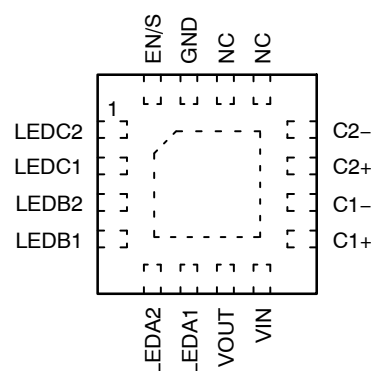

(Top View)

### MARKING DIAGRAMS

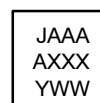

JAAA = CAT3636HV3-T2

JAAR = CAT3636HV3-GT2

A = Assembly Location

XXX = Last Three Digits of Assembly Lot Number

Y = Production Year (Last Digit)

WW = Production Week (Two Digits)

### ORDERING INFORMATION

Device	Package	Shipping†
CAT3636HV3-T2 (Note 1)	TQFN-16 (Pb-Free)	2000/ Tape & Reel
CAT3636HV3-GT2 (Note 2)	TQFN-16 (Pb-Free)	

†For information on tape and reel specifications, including part orientation and tape sizes, please refer to our Tape and Reel Packaging Specifications Brochure, BRD8011/D.

1. Matte-Tin Plated Finish (RoHS-compliant).
2. NiPdAu Plated Finish (RoHS-compliant).

# CAT3636

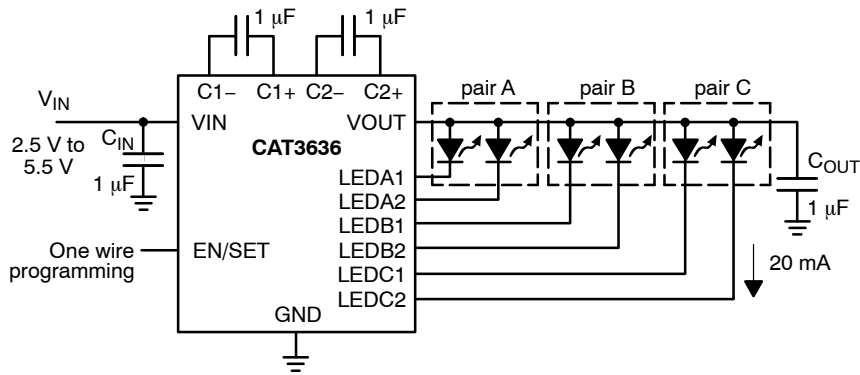

Figure 1. Typical Application Circuit

Table 1. ABSOLUTE MAXIMUM RATINGS

Parameter	Rating	Unit
VIN, LEDx, C1±, C2± voltage	6	V
VOU Voltage	7	V
EN/SET Voltage	VIN + 0.7 V	V
Storage Temperature Range	-65 to +160	°C
Junction Temperature Range (Note 3)	-40 to +150	°C
Lead Temperature	300	°C

Stresses exceeding those listed in the Maximum Ratings table may damage the device. If any of these limits are exceeded, device functionality should not be assumed, damage may occur and reliability may be affected.

Table 2. RECOMMENDED OPERATING CONDITIONS

Parameter	Range	Unit
VIN	2.5 to 5.5	V
Ambient Temperature Range (Note 3)	-40 to +85	°C
ILED per LED pin	0 to 32	mA
Total Output Current	0 to 192	mA

Functional operation above the stresses listed in the Recommended Operating Ranges is not implied. Extended exposure to stresses beyond the Recommended Operating Ranges limits may affect device reliability.

NOTES: Typical application circuit with external components is shown above.

3. Package thermal resistance is below 50°C/W when mounted on FR4 board.

# CAT3636

**Table 3. ELECTRICAL OPERATING CHARACTERISTICS**

(over recommended operating conditions unless specified otherwise) VIN = 3.6 V, EN = High, TAMB = 25°C

Symbol	Name	Conditions	Min	Typ	Max	Units
I <sub>Q</sub>	Quiescent Current	1x mode, VIN = 4.2 V 1.33x mode, VIN = 3.3 V 1.5x mode, VIN = 2.8 V 2x mode, VIN = 2.5 V		1.5 2.8 3.7 3.8		mA
I <sub>QSHDN</sub>	Shutdown Current	V <sub>EN</sub> = 0 V			1	μA
I <sub>LED-ACC</sub>	LED Current Accuracy	1 mA ≤ I <sub>LED</sub> ≤ 31 mA		±3		%
I <sub>LED-DEV</sub>	LED Channel Matching	$\frac{I_{LED} - I_{LEDAVG}}{I_{LEDAVG}}$		±1		%
R <sub>OUT</sub>	Output Resistance (open loop)	1x mode, I <sub>OUT</sub> = 100 mA 1.33x mode, I <sub>OUT</sub> = 100 mA 1.5x mode, I <sub>OUT</sub> = 100 mA 2x mode, I <sub>OUT</sub> = 100 mA		0.5 4.5 3.5 6		Ω
F <sub>OSC</sub>	Charge Pump Frequency	1.33x and 2x mode 1.5x mode	0.6 0.8	0.8 1.1	1.1 1.4	MHz
I <sub>SC_MAX</sub>	Output short circuit Current Limit	V <sub>OUT</sub> < 0.5 V		80		mA
LED <sub>TH</sub>	1x to 1.33x or 1.33x to 1.5x or 1.5x to 2x Transition Thresholds at any LEDxx pin			150		mV
V <sub>HYS</sub>	1.33x to 1x Transition Hysteresis	V <sub>IN</sub> - Highest LED V <sub>F</sub>		400		mV
T <sub>DF</sub>	Transition Filter Delay			500		μs
I <sub>IN_MAX</sub>	Input Current Limit	V <sub>OUT</sub> > 1 V		450		mA
R <sub>EN/DIM</sub> V <sub>HI</sub> V <sub>LO</sub>	EN/DIM Pin - Internal Pull-down Resistor - Logic High Level - Logic Low Level		1.3	100	0.4	kΩ V V
T <sub>SD</sub>	Thermal Shutdown			150		°C
T <sub>HYS</sub>	Thermal Hysteresis			20		°C
V <sub>UVLO</sub>	Undervoltage lockout (UVLO) threshold			2		V

Product parametric performance is indicated in the Electrical Characteristics for the listed test conditions, unless otherwise noted. Product performance may not be indicated by the Electrical Characteristics if operated under different conditions.

**Table 4. RECOMMENDED EN/SET TIMING** (For 2.5 ≤ VIN ≤ 5.5 V, over full ambient temperature range -40 to +85°C.)

Symbol	Name	Conditions	Min	Typ	Max	Units
T <sub>SETUP</sub>	EN/SET setup from shutdown		10		100 (Note 4)	μs
T <sub>LO</sub>	EN/SET program low time		0.2		100	μs
T <sub>HI</sub>	EN/SET program high time		0.2		100	μs
T <sub>OFF</sub>	EN/SET low time to shutdown		1.5			ms
T <sub>DATADELAY</sub>	EN/SET Delay to DATA		500		1000	μs
T <sub>RESETDELAY</sub>	EN/SET Delay High to ADDRESS		2			ms

4. If the Max value is exceeded then the user should wait 2 ms before trying to program the device again.

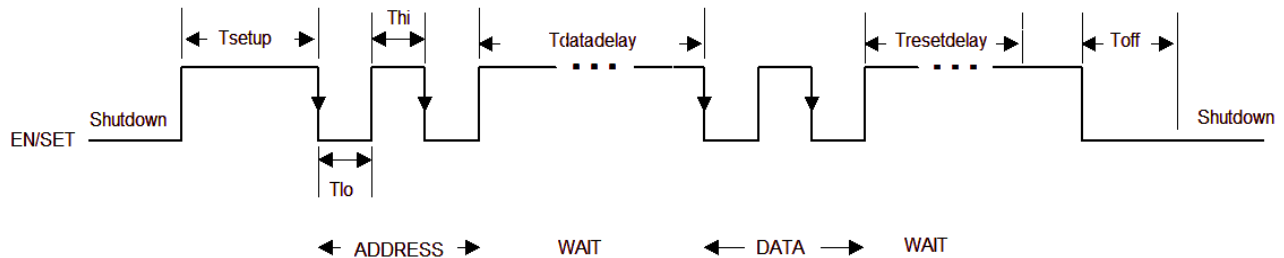

**Figure 2. EN/SET One Wire Addressable Timing Diagram**

TYPICAL PERFORMANCE CHARACTERISTICS

( $V_{IN} = 3.6\text{ V}$ ,  $I_{OUT} = 120\text{ mA}$  (6 LEDs at 20 mA),  $C_{IN} = C_{OUT} = C1 = C2 = 1\ \mu\text{F}$ ,  $T_{AMB} = 25^\circ\text{C}$  unless otherwise specified.)

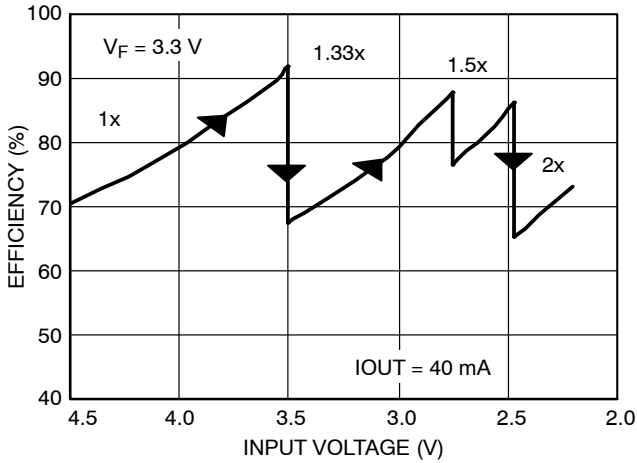

Figure 3. Efficiency vs. Input Voltage

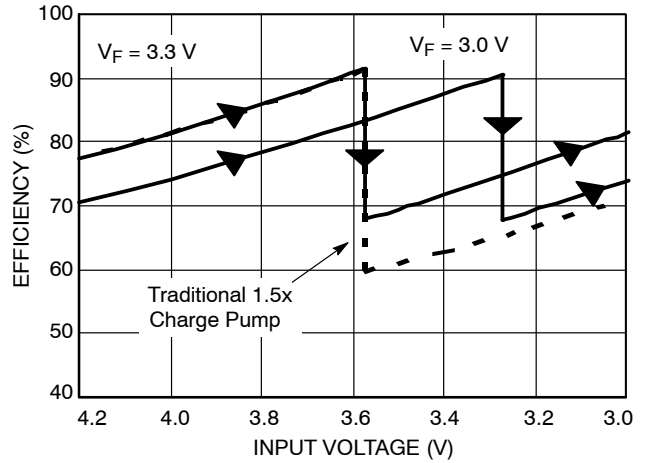

Figure 4. Efficiency vs. Li-Ion Voltage

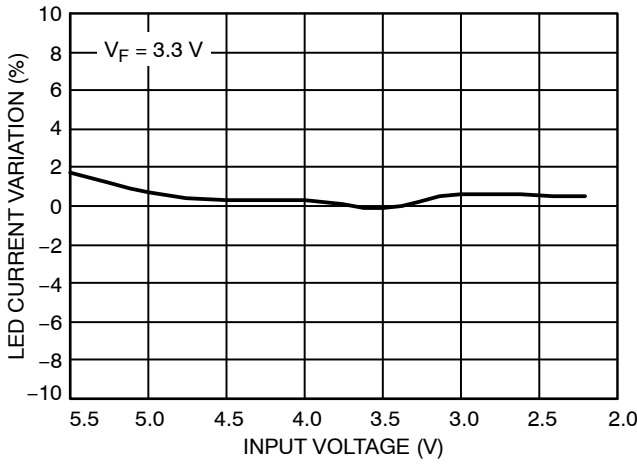

Figure 5. LED Current Change vs. Input Voltage

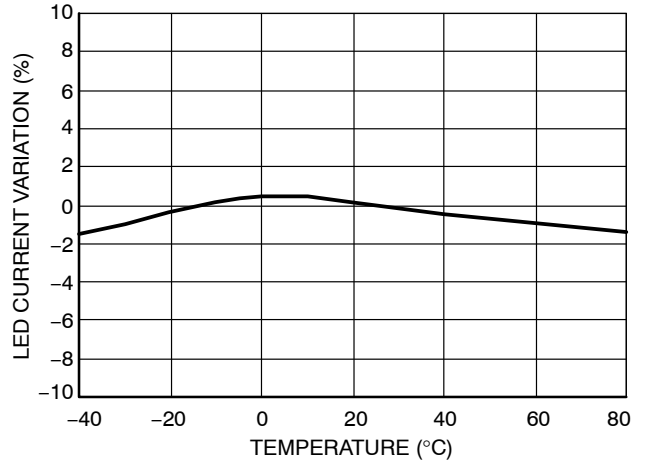

Figure 6. LED Current Change vs. Temperature

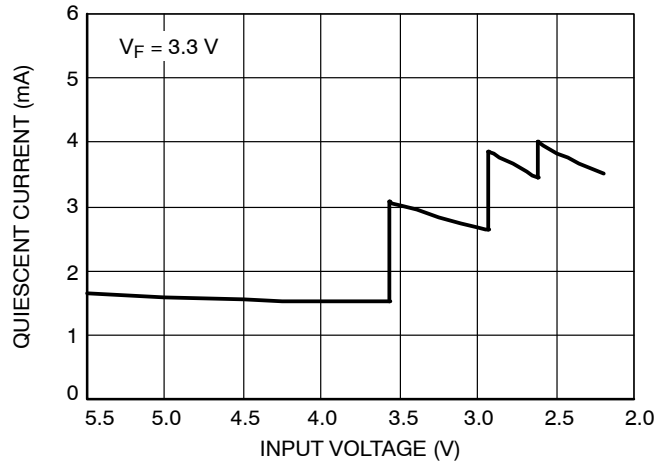

Figure 7. Quiescent Current vs. Input Voltage

TYPICAL PERFORMANCE CHARACTERISTICS

( $V_{IN} = 3.6\text{ V}$ ,  $I_{OUT} = 120\text{ mA}$  (6 LEDs at 20 mA),  $C_{IN} = C_{OUT} = C1 = C2 = 1\ \mu\text{F}$ ,  $T_{AMB} = 25^\circ\text{C}$  unless otherwise specified.)

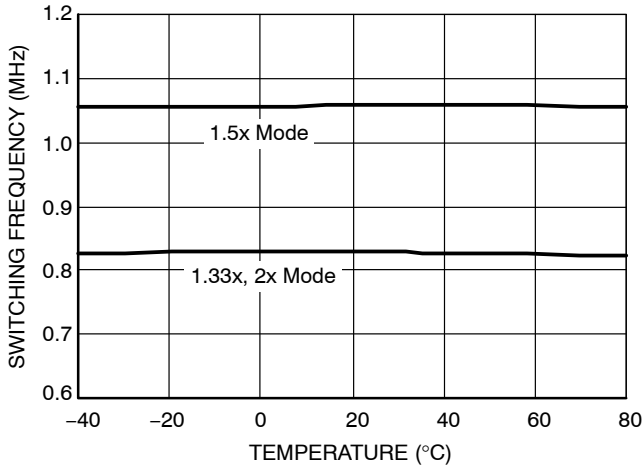

Figure 8. Switching Frequency vs. Temperature

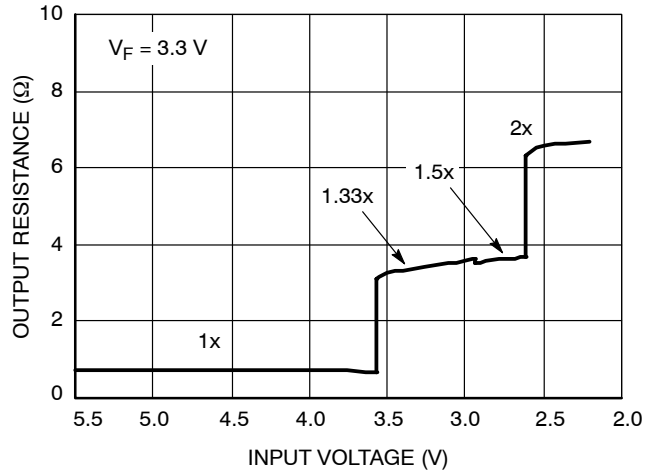

Figure 9. Output Resistance vs. Input Voltage

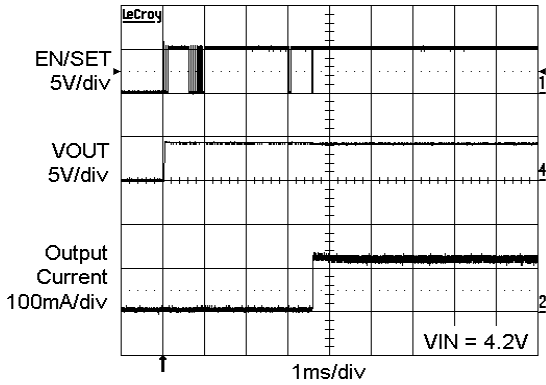

Figure 10. Power Up in 1x Mode

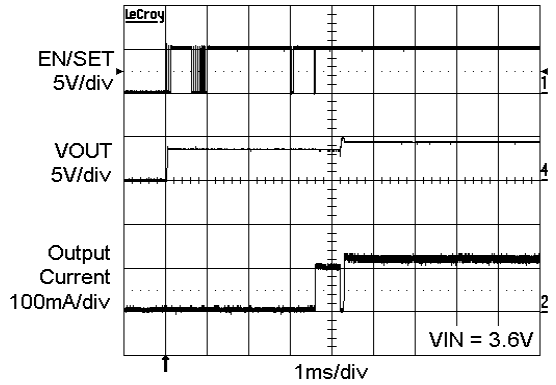

Figure 11. Power Up in 1.33x Mode

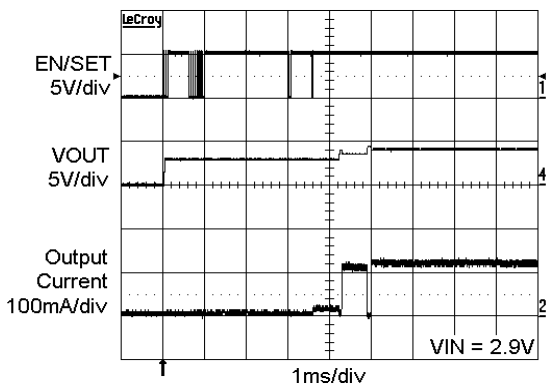

Figure 12. Power Up in 1.5x Mode

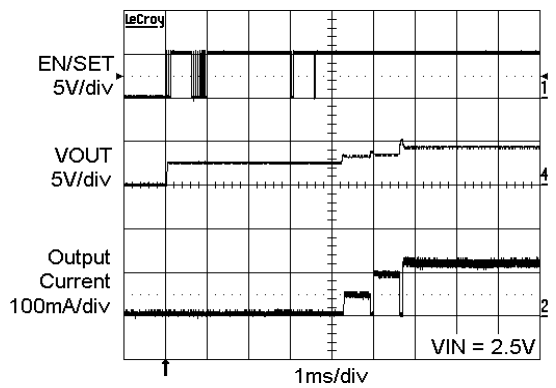

Figure 13. Power Up in 2x Mode

TYPICAL PERFORMANCE CHARACTERISTICS

( $V_{IN} = 3.6\text{ V}$ ,  $I_{OUT} = 120\text{ mA}$  (6 LEDs at 20 mA),  $C_{IN} = C_{OUT} = C_1 = C_2 = 1\ \mu\text{F}$ ,  $T_{AMB} = 25^\circ\text{C}$  unless otherwise specified.)

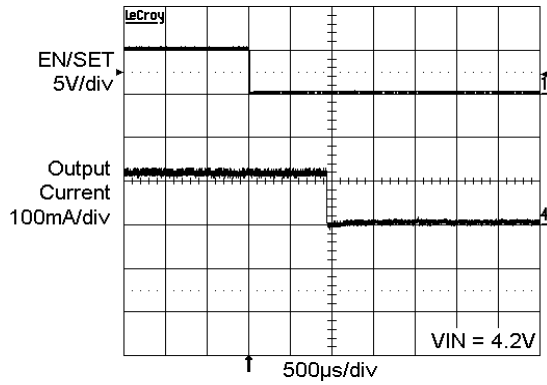

Figure 14. Power Down Delay (1x Mode)

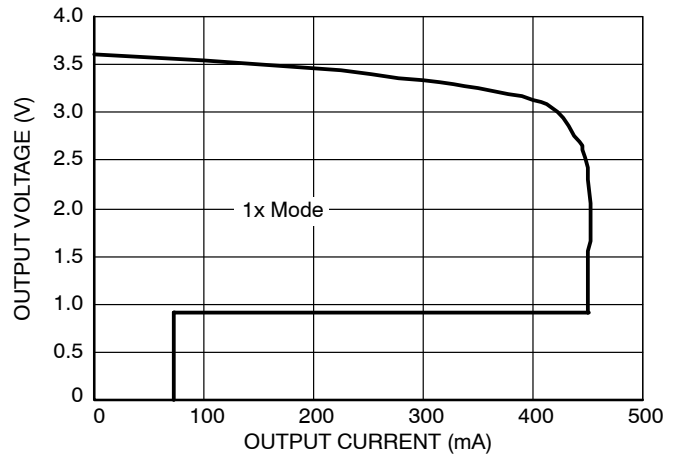

Figure 15. Foldback Current Limit

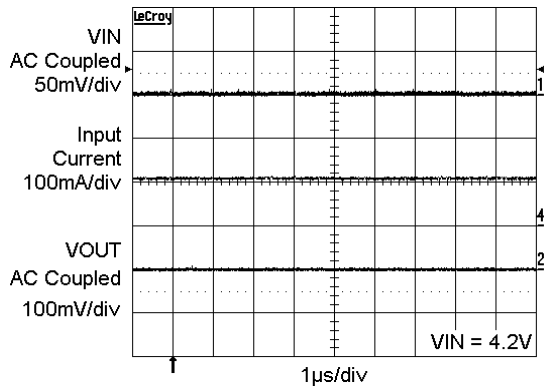

Figure 16. Operating Waveforms in 1x Mode

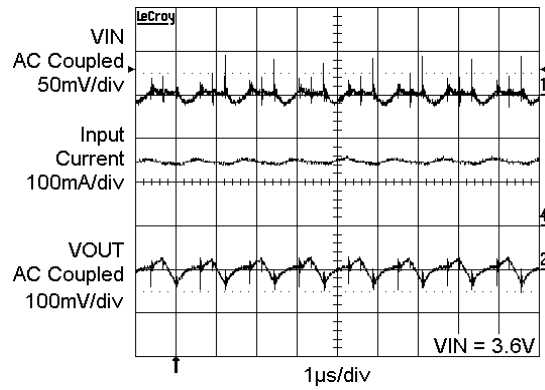

Figure 17. Switching Waveforms in 1.33x Mode

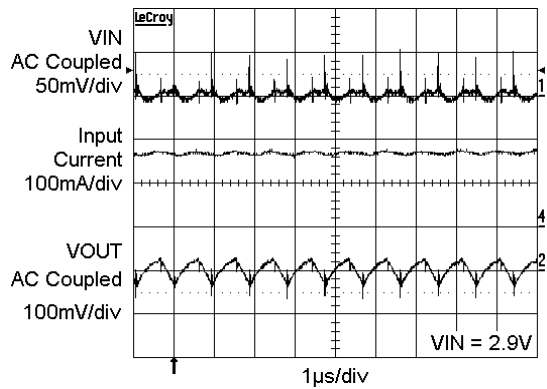

Figure 18. Switching Waveforms in 1.5x Mode

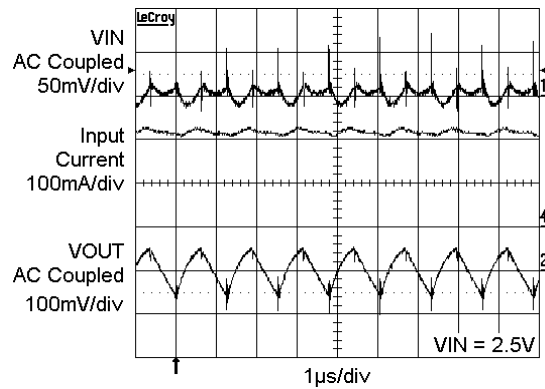

Figure 19. Switching Waveforms in 2x Mode

Table 5. PIN DESCRIPTION

Pin #	Name	Function
1	LEDC2	LEDC2 cathode terminal
2	LEDC1	LEDC1 cathode terminal
3	LEDB2	LEDB2 cathode terminal
4	LEDB1	LEDB1 cathode terminal
5	LEDA2	LEDA2 cathode terminal
6	LEDA1	LEDA1 cathode terminal
7	VOUT	Charge pump output, connect to LED anodes
8	VIN	Charge pump input, connect to battery or supply
9	C1+	Bucket capacitor 1, positive terminal
10	C1-	Bucket capacitor 1, negative terminal
11	C2+	Bucket capacitor 2, positive terminal
12	C2-	Bucket capacitor 2, negative terminal
13/14	NC	No connect
15	GND	Ground reference
16	EN/SET	Device enable (active high) and 1 wire control input
TAB	TAB	Connect to GND on the PCB

**Pin Function**

**VIN** is the supply pin for the charge pump. A small 1  $\mu$ F ceramic bypass capacitor is required between the VIN pin and ground near the device. The operating input voltage range is from 2.5 V to 5.5 V. Whenever the input supply falls below the under-voltage threshold (2 V) all the LED channels will be automatically disabled and the device register are reset to default values.

**EN/SET** is the enable and one wire addressable control logic input for all LED channels. Guaranteed levels of logic high and logic low are set at 1.3 V and 0.4 V respectively. When EN/SET is initially taken high, the device becomes enabled and all LED currents remain at 0 mA. To place the device into zero current mode, the EN/SET pin must be held low for more than 1.5 ms.

**VOUT** is the charge pump output that is connected to the LED anodes. A small 1  $\mu$ F ceramic bypass capacitor is required between the VOUT pin and ground near the device.

**GND** is the ground reference for the charge pump. The pin must be connected to the ground plane on the PCB.

**C1+, C1-** are connected to each side of the ceramic bucket capacitor C1.

**C2+, C2-** are connected to each side of the ceramic bucket capacitor C2.

**LEDxx** provide the internal regulated current for each of the LED cathodes. These pins enter high-impedance zero current state whenever the device is placed in shutdown mode.

**TAB** is the exposed pad underneath the package. For best thermal performance, the tab should be soldered to the PCB and connected to the ground plane.

# CAT3636

## Block Diagram

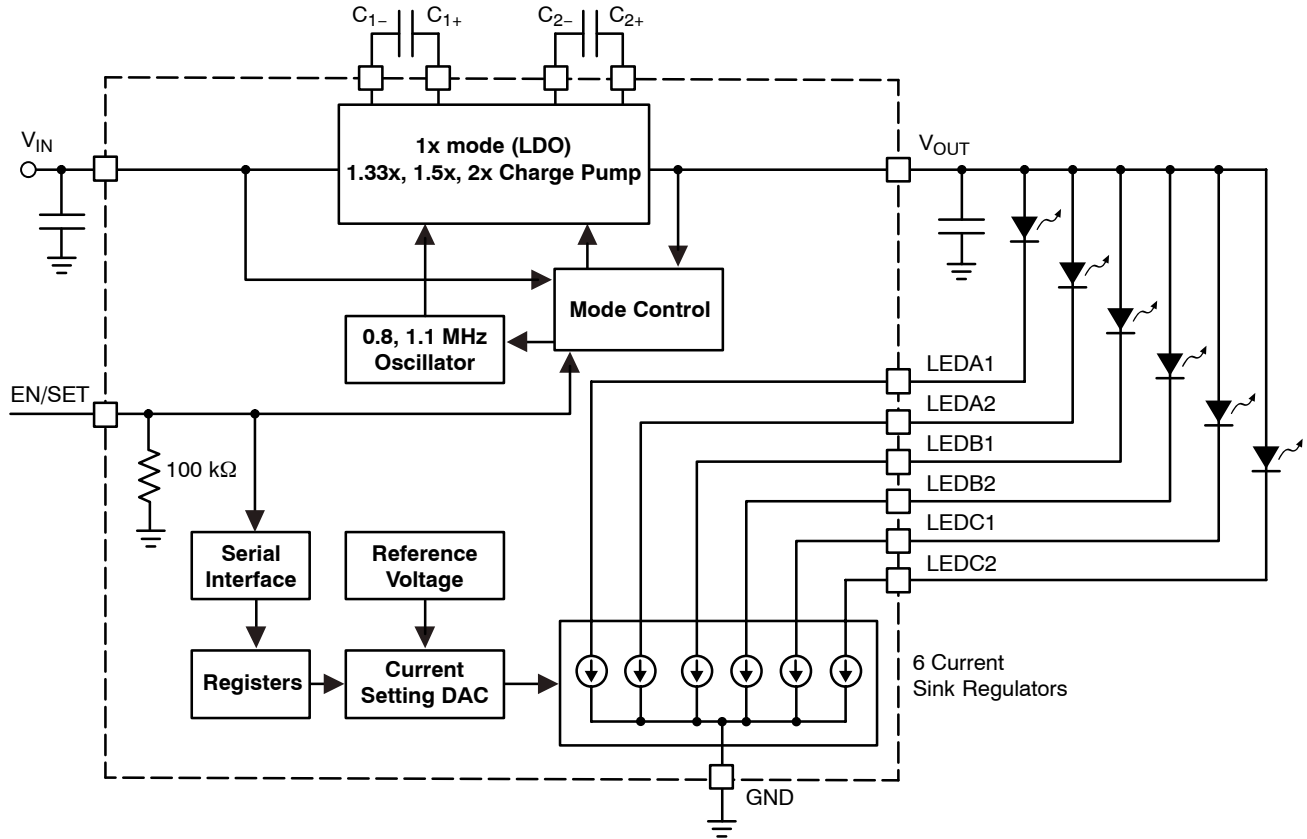

Figure 20. CAT3636 Functional Block Diagram

## Basic Operation

At power-up, the CAT3636 starts operating in 1x mode where the output will be approximately equal to the input supply voltage (less any internal voltage losses). If the output voltage is sufficient to regulate all LED currents, the device remains in 1x operating mode.

If the input voltage is insufficient or falls to a level where the regulated currents cannot be maintained, the device automatically switches into 1.33x mode (after a fixed delay time of about 400  $\mu$ s). In 1.33x mode, the output voltage is approximately equal to 1.33 times the input supply voltage (less any internal voltage losses).

If the input voltage is insufficient again or falls to a level where the regulated currents cannot be maintained, the

device will automatically switch to the 1.5x boost mode (after a fixed delay time of about 400  $\mu$ s). In 1.5x mode, the output is approximately equal to 1.5 times the input supply voltage (less any internal voltage losses).

If the input voltage fails more or is still insufficient to drive the LEDs, it will automatically switch again into 2x mode where the output is approximately equal to 2 times the input supply voltage (less any internal voltage losses).

If the device detects a sufficient input voltage is present to drive all LED currents in 1x mode, it will change automatically back to 1x mode. This only applies for changing back to the 1x mode



**LED Current Setting**

The current in each of the six LED channels is programmed through the 1-wire EN/SET digital control input. By pulsing this signal according to a specific protocol, a set of internal registers can be addressed and written into allowing to configure each bank of LEDs with the desired current. There are six registers: the first five are 4 bits long and the sixth is 1 bit long. The registers are programmed by first selecting the register address and then programming data into that register.

An internal counter records the number of falling edges to identify the address and data. The address is serially programmed adhering to low and high duration time delays. One down pulse corresponds to register 1 being selected. Two down pulses correspond to register 2 being selected and so on up to register 6.  $T_{LO}$  and  $T_{HI}$  must be within 200 ns to 100  $\mu$ s. Anything below 200 ns may be ignored.

Once the final rising edge of the address pointer is programmed, the user must wait 500  $\mu$ s to 1000  $\mu$ s before programming the first data pulse falling edge. If the falling edge of the data is not received within 1000  $\mu$ s, the device will revert back to waiting for an address.

Data in a register is reset once it is selected by the address pointer. If a register is selected but no data is programmed, then the register value is reset back to its initial default value with all data bits to 0.

Once the final rising edge of the data pulses is programmed, the user must wait 1.5 ms before programming another address. If programming fails or is interrupted, the user must wait  $T_{RESETDELAY}$  2 ms from the last rising edge before reprogramming can commence.

Upon power-up, the device automatically starts looking for an address. The device requires a minimum 10  $\mu$ s delay ( $T_{SETUP}$ ) to ensure the initialization of the internal logic at power-up. After this time delay, the device registers may be programmed adhering to the timing constraints shown in Figure 21. If no falling edge is detected within 100  $\mu$ s of power-up, then the user must wait 2 ms before trying to program the device again.

To power-down the device and turn-off all current sources, the EN/SET input should be kept low for a duration  $T_{OFF}$  of 1.5 ms or more. The driver typically powers-down with a delay of about 1 ms. All register data are lost.

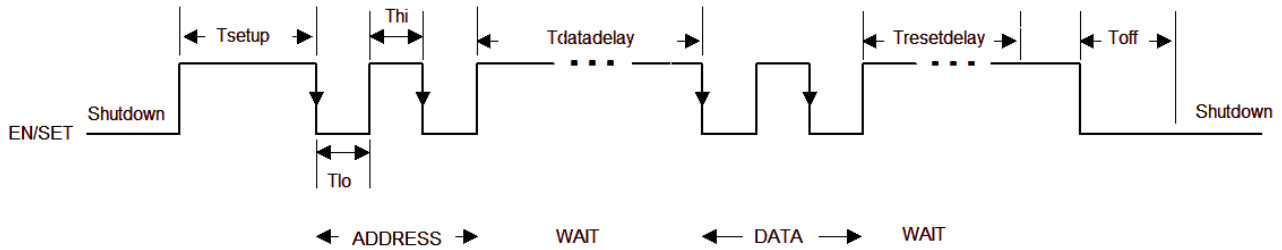

**Figure 21. EN/SET One Wire Addressable Timing Diagram**

Register Configuration and Programming

Table 6. REGISTER ADDRESS AND DATA

Register	Address Pulses	Description	Bits	DATA Pattern			
				Bit 3	Bit 2	Bit 1	Bit 0
REG1	1	Bank Enable and IMODE	4	IMODE	ENA	ENB	ENC
REG2	2	Global Current Setting	4	See Table 8 for values			
REG3	3	Bank A Current Setting	4				
REG4	4	Bank B Current Setting	4				
REG5	5	Bank C Current Setting	4				
REG6	6	Return Lockout	1				RTLKO

Register REG1 allows to set the mode and select the pairs of LEDs to be turned on. A low LED current mode exists to allow for very low current operation under 4 mA per channel. If IMODE equals 1, the high current range is selected up to 32 mA. If IMODE is set to 0, all currents are divided by 8. Each bank of LEDs (A, B or C) can be turned on independently by setting the respective bit ENA, ENB, ENC to 1, as shown in Table 7. For example, to enable all 6 LEDs in low current mode, REG1 is programmed to 0111 binary (9 data pulses).

Table 7. REG1 REGISTER SETTING

Data Pulses	REG1 Value (binary)	IMODE	Bank Enable		
			ENA	ENB	ENC
0	0000	0	-	-	-
1	1111	1	On	On	On
2	1110	1	On	On	-
3	1101	1	On	-	On
4	1100	1	On	-	-
5	1011	1	-	On	On
6	1010	1	-	On	-
7	1001	1	-	-	On
8	1000	1	-	-	-
9	0111	0	On	On	On
10	0110	0	On	On	-
11	0101	0	On	-	On
12	0100	0	On	-	-
13	0011	0	-	On	On
14	0010	0	-	On	-
15	0001	0	-	-	On
16	0000	0	-	-	-

Register REG2 allows to set the same current for all 6 channels. REG3, REG4, REG5 allow to set the current respectively in banks A, B and C. The three banks can be programmed with independent current values.

Table 8. REG2-5 CURRENT SETTING REGISTERS

Data Pulses	REGx Value (binary)	LED Current IMODE = 0	LED Current IMODE = 1
0	0000	0.0 mA	2 mA
1	1111	3.75 mA	32 mA
2	1110	3.5 mA	30 mA
3	1101	3.25 mA	28 mA
4	1100	3 mA	26 mA
5	1011	2.75 mA	24 mA
6	1010	2.5 mA	22 mA
7	1001	2.25 mA	20 mA
8	1000	2 mA	18 mA
9	0111	1.75 mA	16 mA
10	0110	1.5 mA	14 mA
11	0101	1.25 mA	12 mA
12	0100	1 mA	10 mA
13	0011	0.75 mA	8 mA
14	0010	0.5 mA	6 mA
15	0001	0.25 mA	4 mA
16	0000	0.0 mA	2 mA

REG6 contains the return lockout (RTLKO) bit. This stops the charge pump returning to 1x mode. One pulse sets it to 1. Two pulses or no pulses set RTLKO to 0. When RTLKO is set to 1, the charge pump cannot automatically return to 1x mode when in one of the charge pump modes. The device can however move from 1x to 1.33x to 1.5x to 2x if the input voltage is not sufficient to drive the programmed LED currents.

REG6 also triggers a charge pump reset as soon as it is addressed. This forces the charge pump to start from 1x mode and reassess the correct mode it should be in to drive the LEDs most efficiently. If the input voltage has risen or the device has been reprogrammed to other LED values, it is recommended to trigger this reset allowing the charge pump to run in the most efficient mode.

The CAT3636 enters a “zero current” shutdown mode if EN/SET is held low for 1.5 ms or more. All registers are reset back to zero when the device is placed in shutdown.

Programming Examples

Programming 6 LEDs to 32 mA

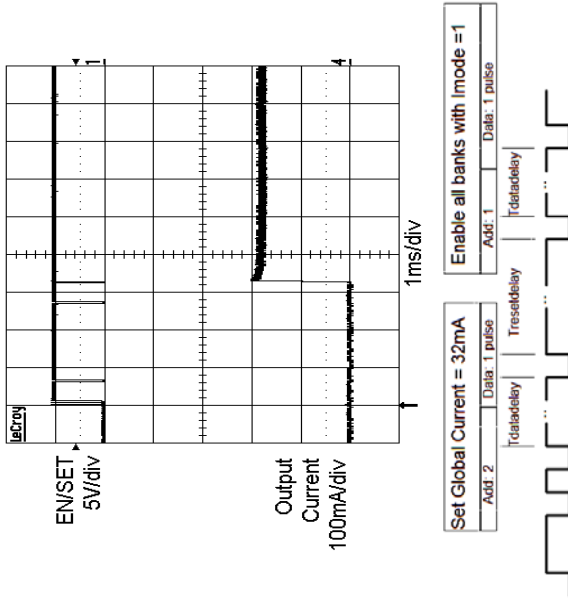

Programming 6 LEDs to 20 mA

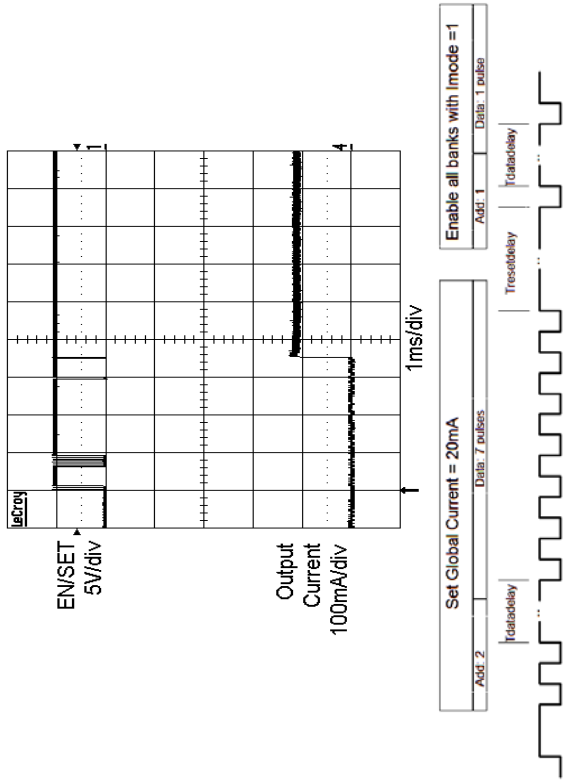

Programming 6 LEDs to 1 mA

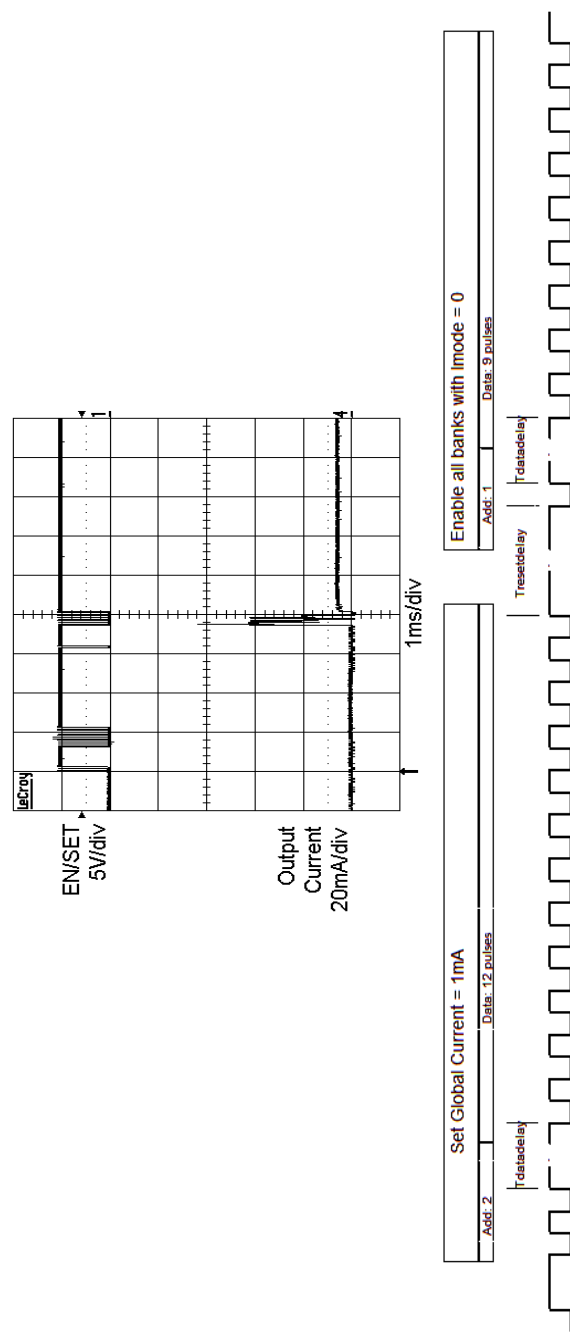

## Unused LED Channels

For applications with only four or two LEDs, unused LED banks can be disabled via the enable register internally and left to float.

For applications with 5 LEDs or less, unused LEDs can also be disabled by connecting the LED pin directly to V<sub>OUT</sub>, as shown on Figure 22. If LED pin voltage is within 1 V of V<sub>OUT</sub>, then the channel is switched off and a 200  $\mu$ A test current is placed in the channel to sense when the channel moves below V<sub>OUT</sub> – 1 V.

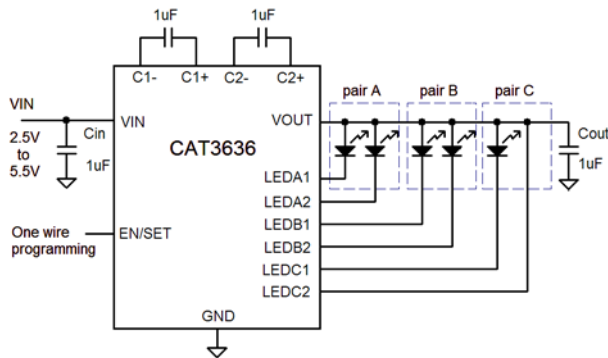

Figure 22. Five LED Application

## Protection Mode

If an LED is disconnected, the output voltage V<sub>OUT</sub> automatically limits at about 5.5 V. This is to prevent the output pin from exceeding its absolute maximum rating.

If the die temperature exceeds +150°C the driver will enter a thermal protection shutdown mode. When the device temperature drops by about 20°C the device will resume normal operation.

## LED Selection

LEDs with forward voltages (V<sub>F</sub>) ranging from 1.3 V to 5.0 V may be used with the CAT3636. Selecting LEDs with lower V<sub>F</sub> is recommended in order to improve the efficiency by keeping the driver in 1x mode longer as the battery voltage decreases.

For example, if a white LED with a V<sub>F</sub> of 3.3 V is selected over one with V<sub>F</sub> of 3.5 V, the CAT3636 will stay in 1x mode for lower supply voltage of 0.2 V. This helps improve the efficiency and extends battery life.

## External Components

The driver requires two external 1  $\mu$ F ceramic capacitors for decoupling input, output, and for the charge pump. Both capacitors type X5R and X7R are recommended for the LED driver application. In all charge pump modes, the input current ripple is kept very low by design and an input bypass capacitor of 1  $\mu$ F is sufficient.

In 1x mode, the device operates in linear mode and does not introduce switching noise back onto the supply.

## Recommended Layout

In charge pump mode, the driver switches internally at a high frequency. It is recommended to minimize trace length to all four capacitors. A ground plane should cover the area under the driver IC as well as the bypass capacitors. Short connection to ground on capacitors C<sub>IN</sub> and C<sub>OUT</sub> can be implemented with the use of multiple via. A copper area matching the TQFN exposed pad (TAB) must be connected to the ground plane underneath. The use of multiple via improves the package heat dissipation.

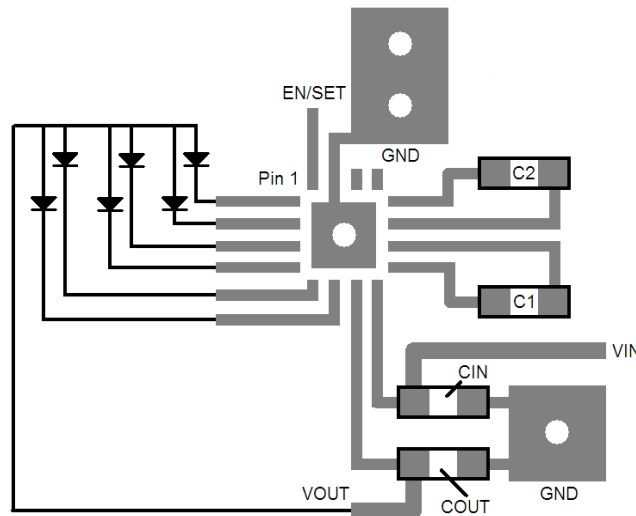
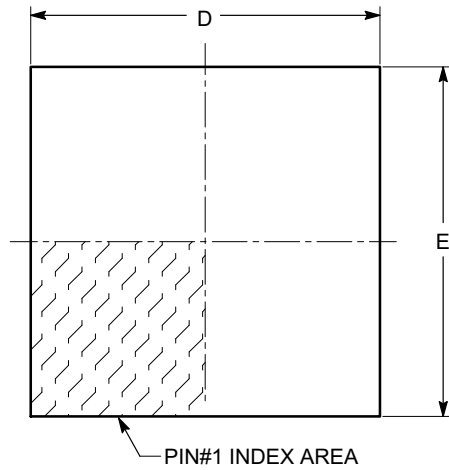

Figure 23. Recommended Layout

# CAT3636

## PACKAGE DIMENSIONS

TQFN16, 3x3  
CASE 510AD  
ISSUE A



TOP VIEW

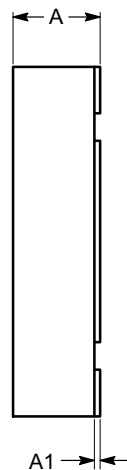

SIDE VIEW

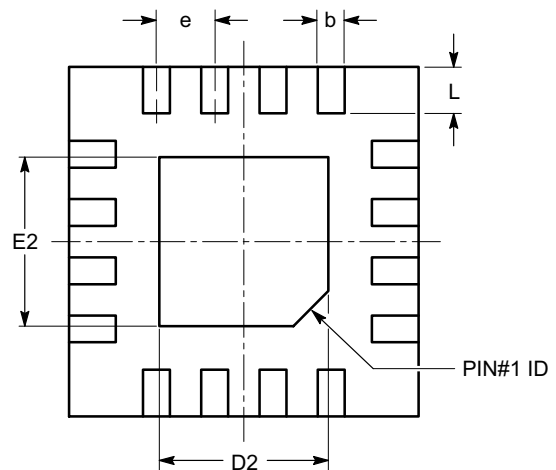

BOTTOM VIEW

SYMBOL	MIN	NOM	MAX
A	0.70	0.75	0.80
A1	0.00	0.02	0.05
A3	0.20 REF		
b	0.18	0.25	0.30
D	2.90	3.00	3.10
D2	1.40	---	1.80
E	2.90	3.00	3.10
E2	1.40	---	1.80
e	0.50 BSC		
L	0.30	0.40	0.50

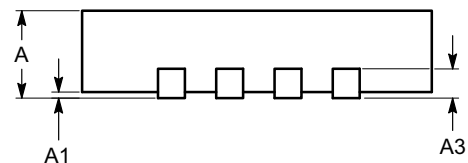

FRONT VIEW

**Notes:**

- (1) All dimensions are in millimeters.
- (2) Complies with JEDEC MO-220.

- 5. All packages are RoHS-compliant (Pb-Free, Halogen-Free).
- 6. The standard lead finish is NiPdAu.
- 7. For Matte-Tin package option, please contact your nearest ON Semiconductor Sales office.

ON Semiconductor and the are registered trademarks of Semiconductor Components Industries, LLC (SCILLC) or its subsidiaries in the United States and/or other countries. SCILLC owns the rights to a number of patents, trademarks, copyrights, trade secrets, and other intellectual property. A listing of SCILLC's product/patent coverage may be accessed at [www.onsemi.com/site/pdf/Patent-Marking.pdf](http://www.onsemi.com/site/pdf/Patent-Marking.pdf). SCILLC reserves the right to make changes without further notice to any products herein. SCILLC makes no warranty, representation or guarantee regarding the suitability of its products for any particular purpose, nor does SCILLC assume any liability arising out of the application or use of any product or circuit, and specifically disclaims any and all liability, including without limitation special, consequential or incidental damages. "Typical" parameters which may be provided in SCILLC data sheets and/or specifications can and do vary in different applications and actual performance may vary over time. All operating parameters, including "Typicals" must be validated for each customer application by customer's technical experts. SCILLC does not convey any license under its patent rights nor the rights of others. SCILLC products are not designed, intended, or authorized for use as components in systems intended for surgical implant into the body, or other applications intended to support or sustain life, or for any other application in which the failure of the SCILLC product could create a situation where personal injury or death may occur. Should Buyer purchase or use SCILLC products for any such unintended or unauthorized application, Buyer shall indemnify and hold SCILLC and its officers, employees, subsidiaries, affiliates, and distributors harmless against all claims, costs, damages, and expenses, and reasonable attorney fees arising out of, directly or indirectly, any claim of personal injury or death associated with such unintended or unauthorized use, even if such claim alleges that SCILLC was negligent regarding the design or manufacture of the part. SCILLC is an Equal Opportunity/Affirmative Action Employer. This literature is subject to all applicable copyright laws and is not for resale in any manner.

**PUBLICATION ORDERING INFORMATION**

**LITERATURE FULFILLMENT:**  
Literature Distribution Center for ON Semiconductor  
P.O. Box 5163, Denver, Colorado 80217 USA  
**Phone:** 303-675-2175 or 800-344-3860 Toll Free USA/Canada  
**Fax:** 303-675-2176 or 800-344-3867 Toll Free USA/Canada  
**Email:** [orderlit@onsemi.com](mailto:orderlit@onsemi.com)

**N. American Technical Support:** 800-282-9855 Toll Free  
USA/Canada  
**Europe, Middle East and Africa Technical Support:**  
Phone: 421 33 790 2910  
**Japan Customer Focus Center**  
Phone: 81-3-5817-1050

**ON Semiconductor Website:** [www.onsemi.com](http://www.onsemi.com)  
**Order Literature:** <http://www.onsemi.com/orderlit>  
For additional information, please contact your local Sales Representative