



**MVS-2027 / 2067
MACHINE VISION STROBE**

OPERATION MANUAL

Excelitas Technologies Corp.
35 Congress St., Salem, MA 01970 USA
Phone: (978)745-3200 FAX: (978)745-0894
Toll Free: (800)950-3441 in USA only
Website <http://www.excelitas.com>



WARNING!

The MVS-2027 produces lethal voltages. Ensure that input power is disconnected and storage capacitors have been discharged before beginning any inspection or internal adjustment.

WARNUNG!

Das MVS-2027 erzeugt lebensgefährliche Spannungen. Es muss deshalb darauf geachtet werden, dass der ankommende Strom ausgeschaltet ist und die Ladekondensatoren entladen sind, bevor Kontrollen oder Regelungen am Gerät unternommen werden!

ATTENTION!

Le MVS-2027 fournit des tensions dangereuses. Veuillez vérifier que la prise de courant est déconnectée et les condensateurs d'accumulation sont déchargés avant d'entreprendre des inspections ou des réglages sur l'appareil.



WARNING!

The output voltage of the MVS-2027 **MUST** be limited to match the specifications of those components to which it is connected. Exposing any system component to voltage (or any other operating condition) that exceeds its rating can result in damage to the unit and personal injury.



WARNUNG!

Die Ausgangsspannung des MVS-2027 muss der Leistung aller damit verbundenen Komponenten angepasst werden. Systemelemente Spannungen (oder anderen Betriebsbedingungen) auszusetzen, die die Leistungswerte jener Komponenten übertreffen, ist gefährlich und kann zu Schäden und Verletzungen führen.

ATTENTION!

Il faut que la tension fournie par le MVS-2027 soit limitée aux caractéristiques des composants auxquels il sera mis en contact. En exposant un composant quelconque à une tension (ou à d'autres conditions de fonctionnement), qui en dépasse la limite on pourrait endommager l'appareil ou provoquer des blessures.



WARNING!

Do not exceed the specified rates for voltage and flashrate. Do not operate at more than 43 watts of average output power.

WARNUNG!

Bitte, die vorgegebenen Grenzwerte bei der Spannung und Blitzfrequenz nicht überertreffen. Leistungen höher als 43 Watt sind nicht zulässig.

ATTENTION!

L Eviter de dépasser les valeurs limits inscites pour la tension et la fréquence d'éclat. Eviter aussi des puissances au dessus de 43 Watt.

TABLE OF CONTENTS

	PAGE
1.0 INTRODUCTION.....	2
1.1 DESCRIPTION.....	2
1.2 UNPACKING.....	2
2.0 SPECIFICATION TABLES.....	4
3.0 INSTALLATION.....	5
3.1 MOUNTING.....	5
3.2 SAFETY REQUIREMENTS.....	5
4.0 OPERATION.....	6
4.1 OUTPUT CONNECTIONS.....	6
4.2 INPUT CONNECTIONS & INTENSITY CONTROL SWITCH.....	7
4.3 INTENSITY ADJUSTMENT (INTERNAL MODE).....	8
4.4 INTENSITY ADJUSTMENT (EXTERNAL MODE).....	9
4.5 VOLTAGE SETTING VERSUS LAMP LIFE.....	10
5.0 MAINTENANCE.....	10
5.1 REPAIRS.....	10
5.2 FLASHLAMP MODULE REPLACEMENT.....	11
5.3 CLEANING.....	12
5.4 REPACKING AND STORAGE.....	12
6.0 DECLARATION OF CONFORMITY.....	14

FIGURES

FIGURE 1. OUTLINE AND MOUNTING DIMENSIONS.....	3
FIGURE 2. SIGNAL INPUT CONNECTOR (J2).....	7
FIGURE 3. INPUT TRIGGER CIRCUIT.....	7
FIGURE 4. SIMPLIFIED SCHEMATIC.....	13

TABLES

TABLE 1. OPTICAL SPECIFICATIONS.....	4
TABLE 2. ELECTRICAL SPECIFICATIONS.....	4
TABLE 3. ENVIRONMENTAL SPECIFICATIONS.....	4
TABLE 4. NOSEPIECES.....	6
TABLE 5. FIBER OPTIC BUNDLES ¹	6
TABLE 6. SIGNAL INPUT CONNECTOR – J2.....	8

1.0 INTRODUCTION

1.1 DESCRIPTION

Machine Vision Strobos (hereafter referred to as the "2027/2067") are sources of short duration, high intensity light pulses for industrial vision applications. The units come complete with an input power cable and a connector for a control input cable. The light source is a Excelitas Technologies high power xenon flashlamp. The light output is focused on a port configured to accept a fiber-optic cable (optional; see Table 4) so that light can be transmitted to an area remote from the instrument.

The 2027/2067 can be used for a wide variety of industrial robotics production applications, including: sorting, package integrity verification, counting, label reading, component orientation, motion sensing, edge detection, contaminant detection, part recognition, color differentiation and quality assurance.

For operation, the 2027/2067 unit requires a TTL input pulse from the camera system to initiate a flash, and connection to a 90-230V AC, 50/60Hz line, single phase with ground.

Please read and follow all safety precautions, such as:



WARNING!

Strobe lights have been known to trigger seizures in people with photosensitive epilepsy.



WARNING!

Any unauthorized modifications could void CE Certification.



WARNING!

A fiber-optic nosepiece is hot after continuous use. Handle with care.



WARNING!

The MVS-2027/2067-UV strobe produces output in the UV range. Whatever system is used, avoid looking directly at the high intensity light flash, whether at the unit itself or at the end of a fiber optic cable, as this can result in damage to the eyes.

1.2 UNPACKING

If the condition of the outer packaging suggests mishandling has occurred, examine the 2027/2607 strobe for any signs of breakage during shipment. The Xenon Flashlamp is particularly vulnerable to rough treatment during shipment. Although the utmost care is taken to preserve the integrity of this item, its fragile nature makes it susceptible to breakage if the container is mishandled in transit. If there are any obvious signs of damage, contact the carrier immediately and do not proceed with the installation. It is recommended that the packaging material be retained and stored in the event that the unit has to be reshipped.

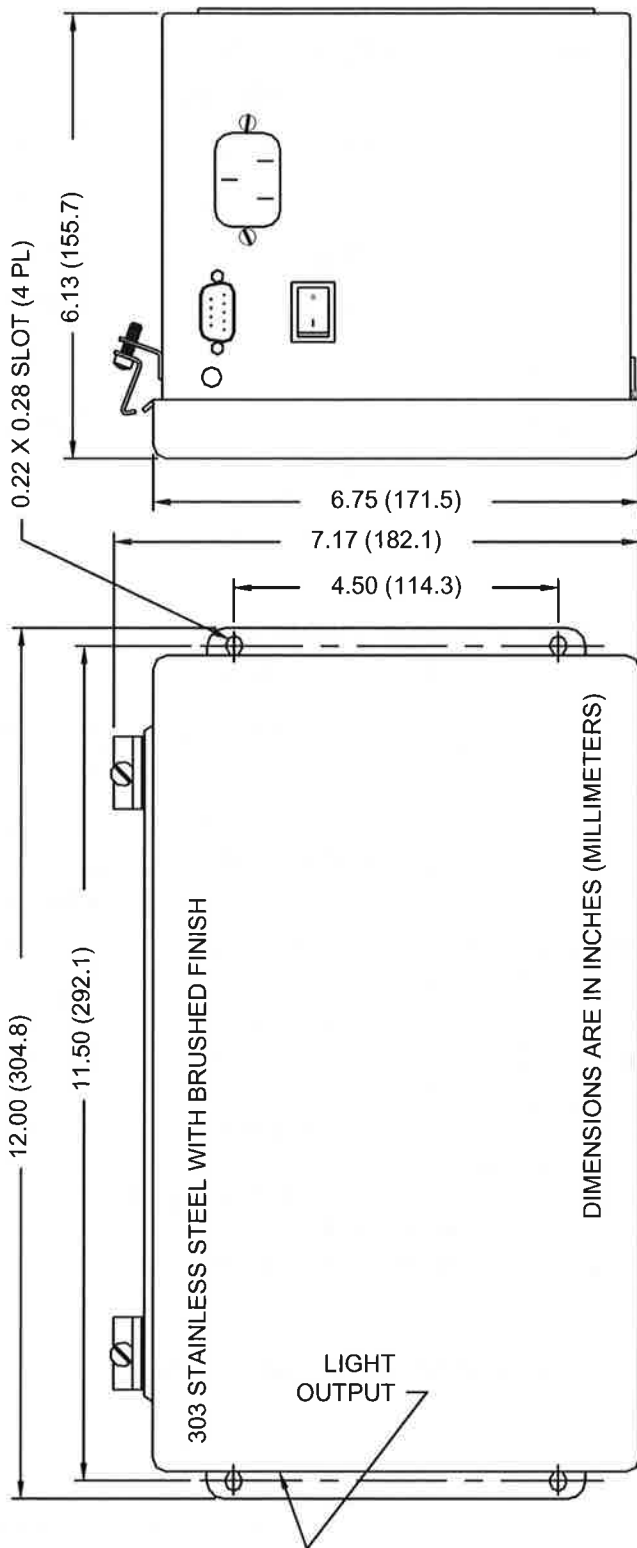

Figure 1. Outline and Mounting Dimensions

2.0 SPECIFICATION TABLES

Table 1. Optical Specifications

	<i>MVS-2027</i>	<i>MVS-2067</i>
Spectral bandwidth	300-1100+nm	300-1100+nm
Spectral bandwidth (-UV)	230-1100+nm	230-1100+nm
Radiometric light output**	50 mJ max.	25 mJ max.
Flash rate in Hz @ 600V*	20 max.	60 max.
Pulse duration @ 1/3 peak	15 µsec	10 µsec
Fiber bundle outside diameter	1.0 inch (25 mm) max.	

*Flash rate is voltage dependent. Do not exceed 43W average power. [Power=Energy x frequency ($P=Ef$) and Energy=1/2 Capacitance x Voltage² ($E=1/2CV^2$)]

**Approximate light output measured through a 1/2" aperture at the light output port (@600VDC).

Table 2. Electrical Specifications

	<i>MVS-2027</i>	<i>MVS-2067</i>
Input voltage	90-230VAC ±10%, 50/60Hz	
Input power	60 Watts	
Trigger input	+5V, 20mA, 10-100µsec pulse (into an opto-isolator with internal 150 ohms nominal series resistor)	
Flashlamp voltage (factory set)	600VDC	600VDC
Discharge capacitor	12µF	4 µF
Input energy per flash @ 600V*	2.16 joules	0.72 joules
Delay between flash command and light output	10µsec (typ)	10µsec (typ)
Ext ref. voltage	3 to 6 volts DC ($V_0 = V_{ref} \times 100$)	

*Flash rate is voltage dependent. Do not exceed 43W average power. [Power=Energy x frequency ($P=Ef$) and Energy=1/2 Capacitance x Voltage² ($E=1/2CV^2$)]

Table 3. Environmental Specifications

Operating temperature	-10° to +110°F (-23° to +43°C)
Storage temperature	-40° to +194°F (-40° to +90°C)
Humidity	0% to 85% Non-Condensing



WARNING!



Because this product is only one component of a system, and, once sold is exclusively under the control of the user, it has the potential of being used in a manner outside the intended purpose of Excelitas Technologies Corp. design.

It is essential that the operating specifications and parameters described in Excelitas Technologies literature and those accompanying other manufacturer's components be observed and not be exceeded under any conditions.

To install or operate this product in a manner for which it is not intended may cause personal injury or **death**, as well as severe damage to the product and/or other system components.

3.0 INSTALLATION

3.1 MOUNTING

Four holes in the base of the 2027/2067 enclosure are available for mounting the unit (see Figure 1). Mounting hardware is user-supplied. Position the unit so that the AC receptacle is accessible as a means of disconnect.

3.2 SAFETY REQUIREMENTS

The MVS-2027/2067 has features related to safety, such as:

To prevent the possibility of injury from *flashlamp breakage*, leave either the **plastic lamp cap** or a **fiber-optic cable** in place at all times. *Do not operate the unit with the lamp cap in place.* See flashlamp replacement warning on page 11.

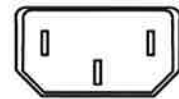

Use the **AC Receptacle** (on the right) as a disconnect device to remove any possibility of electrical input, particularly, when accessing the unit's interior.

4.0 OPERATION

4.1 OUTPUT CONNECTIONS

Use a nosepiece (Table 4) or a nosepiece with adapter to connect a fiber-optic cable (Table 5) to the unit's light output port.* Position the cable to distribute light to the desired area.

Table 4. Nosepieces

TYPE	DESCRIPTION
MVS-22	Fostec Special 1" dia. Nosepiece
MVS-23	Fostec Standard 0.72" dia. Nosepiece
MVS-24	Volpi Standard 0.59" dia. Nosepiece
MVS-25	Dolan Jenner Standard 1.0" dia. Nosepiece (used with 1.0" O.D. Adapter)

Table 5. Fiber Optic Bundles¹

TYPE	DESCRIPTION
MVS-7 Single	Illuminates a small area from one direction; 40 in. (102cm) long.
MVS-7D Dual	Reduces shadows by illuminating from two directions; 40 in. (102cm) long.
MVS-8 Ring Light	Illuminates an area of 2 in. with working distance of 4 in.; dependent on distance from light source and illumination plane; 36.5 in. (93cm) long.
MVS-12 Backlight ²	2x2 in. area; uniformity is $\pm 5\%$ over usable working area; 37 in. (94cm) long.
MVS-13 Backlight ²	4x5 in. area; uniformity is $\pm 5\%$ over usable working area; 37 in. (94cm) long.

¹ See Excelitas Technologies Corp. Data Sheet, Machine Vision Strobe, Fiber Optic Bundles.

² Caution: High intensity may damage *PLASTIC* fiber optic bundles. Contact manufacturer for temperature limits and use IR filter to reduce heat.

* Note: Be sure to remove the safety cover from the output port before operating the unit.

4.2 INPUT CONNECTIONS & INTENSITY CONTROL SWITCH

Two input connections are provided at one end of the enclosure. The larger connector is used to attach the input power cable (supplied).

The smaller, 9-pin connector (see Figure 2) is used to attach a cable for trigger and reference voltage inputs. A mating connector is supplied. Use a shielded cable, 90% coverage or better, 360° terminated to the back of the shell. To trigger the strobe, a +5V TTL pulse (10-100 usec, >20 mA) is required to activate the opto-isolator. The strobe will flash on the rising edge of the positive pulse. Do not exceed 6V since this will result in permanent damage to the strobe. Other logic voltages can be accommodated by the addition of a series resistor (Please Contact Factory). A Trigger Test Module (MVS-103) is available through Excelitas Technologies to test your MVS-2027/2067 strobe. This small module (1½" x 1" x 2½") plugs directly into the D-connector and can be used to verify correct operation of the MVS-2027/2067 strobe unit.

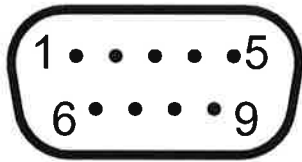

Figure 2. Signal Input Connector (J2)

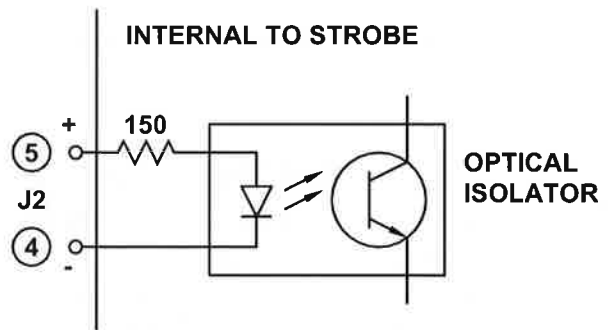

Figure 3. Input Trigger Circuit

The intensity of the MVS-2027/2067 strobe can be adjusted by means of a potentiometer (INTERNAL mode, see section 4.3) or an external reference signal (EXTERNAL mode, see section 4.4). A slide switch S1, located on the main power supply PC board, allows the user to switch from INTERNAL to EXTERNAL mode for intensity adjustment. (Units are shipped with the switch S1 in the INTERNAL position).

Note: With the switch S1 in the EXT. position, an external reference voltage (3-6 VDC) on Pin 3 and Pin 9 is required to operate the strobe. Without this reference signal, the strobe will NOT flash (see section 4.4).

Table 6. Signal Input Connector – J2

	INTERNAL V_{ref} SETTING (S1-INT)	EXTERNAL V_{ref} CONTROL (S1-EXT)
Pin 1	No connection	No connection
Pin 2	No connection	No connection
Pin 3	No connection	V_{ref} : reference signal input voltage, 3-6 VDC ($V_0 = V_{ref} \times 100$)
Pin 4	- Trigger: opto-isolator trigger return	- Trigger: opto-isolator trigger return
Pin 5	+Trigger: opto-isolator trigger input; +5V, 20mA; triggers on rising edge.	+Trigger: opto-isolator trigger input; +5V, 20mA; triggers on rising edge.
Pin 6	No connection	No connection
Pin 7	No connection	No connection
Pin 8	Chassis ground	Chassis ground
Pin 9	No connection	V_{ref} return, supply ground

If External V_{ref} is not used, set slide switch to INT and leave internal ref. at factory setting (600VDC).

4.3 INTENSITY ADJUSTMENT (INTERNAL MODE)

With the slide switch S1, located on the main power supply PC board, in the INT position, the user can change the intensity of the strobe by adjusting a potentiometer without opening the strobe enclosure. This potentiometer is labeled 'Internal VREF Adjust' and is located on the back of the unit just above the signal input connector next to the ON/OFF switch.

By adjusting the 10-turn pot (or 1 turn pot on any of the -03 models), using a small screwdriver, the user can vary the voltage on the main discharge capacitors from 300 VDC to 600 VDC. The intensity or energy per flash will vary as $\frac{1}{2}$ capacitance x (voltage)² (or $E = \frac{1}{2}CV^2$). The voltage has been factory set at 600 VDC. For reliable flashing over the life of the lamp, it is not recommended to operate the strobe at less than 400 VDC.

The actual output voltage setting (300-600 VDC) can be measured by monitoring the internal V_{ref} setting (3-6 VDC) through the signal input connector J2. By disengaging the 9 pin D-connector, the user can measure the DC voltage between Pin 3 and Pin 9. The output voltage is 100 times the reference signal ($V_{out} = V_{ref} \times 100$).

4.4 INTENSITY ADJUSTMENT (EXTERNAL MODE)

To change the intensity adjustment from the factory setting (INTERNAL mode) to an external reference signal (EXTERNAL mode), the user must slide switch S1, located on the main power supply PC board, to the EXT position. This requires opening the enclosure to access the interior of the enclosure.

Please read and follow all safety precautions!

1. Switch off the unit and allow it to cool.
 2. Disconnect the AC cord from the unit.
 3. Wait at least 60 seconds to allow the energy storage capacitors to discharge.
 4. Using a screwdriver, loosen the screws on the clamps holding the cover and open the case.
 5. Ground discharge capacitors with an insulated shorting bar to insure the stored energy is discharged.
 6. Slide switch S1 (at lower left corner of unit and top edge of PC board) to the EXT position.*
 7. Close the cover and secure the clamps before reconnecting the AC cord.
- * To restore the internal voltage adjust, repeat the above procedure and slide the switch to the INT position.

Note: With the switch S1 in the EXT position, an external reference voltage is required to operate the strobe. Without this reference signal the strobe will NOT flash.

An external reference signal can be used to control the intensity of the strobe. A 3-6 VDC reference signal should be connected to pin 3 (Vref) and pin 9 (Vref return). The actual voltage on the storage capacitors is 100 times the reference signal ($V_{out} = V_{ref} \times 100$). The output voltage can be varied from 300 VDC to 600 VDC. The intensity or energy per flash will vary as $\frac{1}{2}$ capacitance x (voltage)² (or $E = \frac{1}{2}CV^2$). For reliable flashing over the life of the lamp, it is not recommended to operate the strobe at less than 400 VDC.

4.5 VOLTAGE SETTING VERSUS LAMP LIFE

Lamp life is dependent on the energy per flash. For maximum lamp life lower the lamp voltage to a minimum, that will allow sufficient light output for your application. However, for reliable flashing over the life of the lamp, it is not recommended to operate the strobe at less than 400 VDC.

5.0 MAINTENANCE

**WARNING!**

The MVS-2027 produces lethal voltages. Ensure that input power is disconnected and storage capacitors have been discharged before beginning any inspection or internal adjustment.



5.1 REPAIRS

The 2027/2067 strobe is, generally speaking, a trouble-free unit. No routine maintenance or repair is suggested, except for replacement of the flashlamp module..

The unit is protected by a 3.15A fuse (Type T), in the AC input. If the fuse opens, do not replace it. Return the unit to the factory for repair.

In the event that the unit fails or does not function properly (other than flashlamp failure), it is strongly suggested that no attempt be made to troubleshoot. Field repairs and customer modifications are not authorized, and, if attempted, will void the warranty. Repairs must be made only by factory-trained personnel.

5.2 FLASHLAMP MODULE REPLACEMENT

	WARNING!	
<p>The flashlamp is a high-pressure, gas-filled device. Wear safety glasses when replacing it. Avoid touching it with bare hands as fingerprints will burn into the glass and affect the life of the lamp.</p>		

Over a period of time (depending on usage), the xenon flashlamp's output may deteriorate, requiring that it be replaced. Either the Lamp Module, p/n XP-0875 (or XP-0896 for UV output), or the lamp alone, p/n 217-8673 (or 217-8677 for UV output), may be replaced, but ***the unit's optical alignment can only be assured by the replacement of the entire module.*** Replacement modules are factory pre-aligned to production standards which ensure that the strobes's output will remain within specification.

If only the lamp is replaced instead of the complete lamp module, the strobes' output may be reduced by up to 20% because of misalignment in the optical system.

To replace the optical module or lamp:

REMOVAL

Note: To replace the optical module, follow Steps 1-6 of the procedure below. To replace just the CP lamp, continue on to Step 7.

1. Remove line voltage from the unit.
2. Wait 60 seconds to allow energy storage capacitors to discharge and open case.
3. Ground discharge capacitors with an insulated shorting bar to ensure that the stored energy is discharged.
4. Disconnect the faston connectors from the lamp module terminals.
5. Remove the screw that holds the module clip in place at the top front of the reflector and lift the clip off.
6. Push down on the module's rear insulator plate to rock the top of the module out of the holder. Lift the module straight up and out.
7. Remove lamp faston and rubber grommet both on the cathode wire from the lamp module.
8. Unscrew CP lamp lug from the heatsink and carefully remove the lamp from the module.

INSTALLATION

Note: To replace the CP lamp, follow Steps 1-7 of the procedure below. To replace just the optical module, skip to Step 3.

1. Place the new lamp through the reflector and secure it into the heatsink. Make sure the lamp tip-off is on the side with the extra clearance.
2. Attach the cathode wire faston to the lug on the inside of the back plate and press the rubber grommet into the slot in the reflector.
3. Place the new lamp module into the case with the cathode lead up.
4. Ensure that the lower edge of the reflector is inserted *inside* of the two upward facing tabs at the bottom of the holder.
5. Using the tabs as a pivot, rock the module up into place between the flared guides. The top edge of the reflector should align with the top edge of the crossbar when the lamp module is properly positioned.
6. Insure that the cathode lead and its grommet are positioned in the slot provided before replacing the module clip and tightening its mounting screw. The mounting screw threads into a self-locking nut which may provide a false sense of tightness. Ensure that the optical module clip is clamping the reflector edge securely before proceeding.
7. Re-attach the leads. Attach the white lead to the center electrode and the black lead to the cathode spade lug.

5.3 CLEANING

After disconnecting power from the unit, clean with a soft cloth dampened with a mild, non-abrasive cleaner and wipe dry. *Never immerse the unit in water or any other liquid.*

5.4 REPACKING AND STORAGE

If the 2027/2067 strobe is to be stored for a prolonged period, shipped to another location, or returned to the factory for repair, it should be repacked in the original packaging material. If this material has been discarded, the unit should be repacked so as to prevent movement within the container and damage from improper handling.

A storage area should be dry, at a temperature of -40°F to +194°F (-40°C to +90°C).

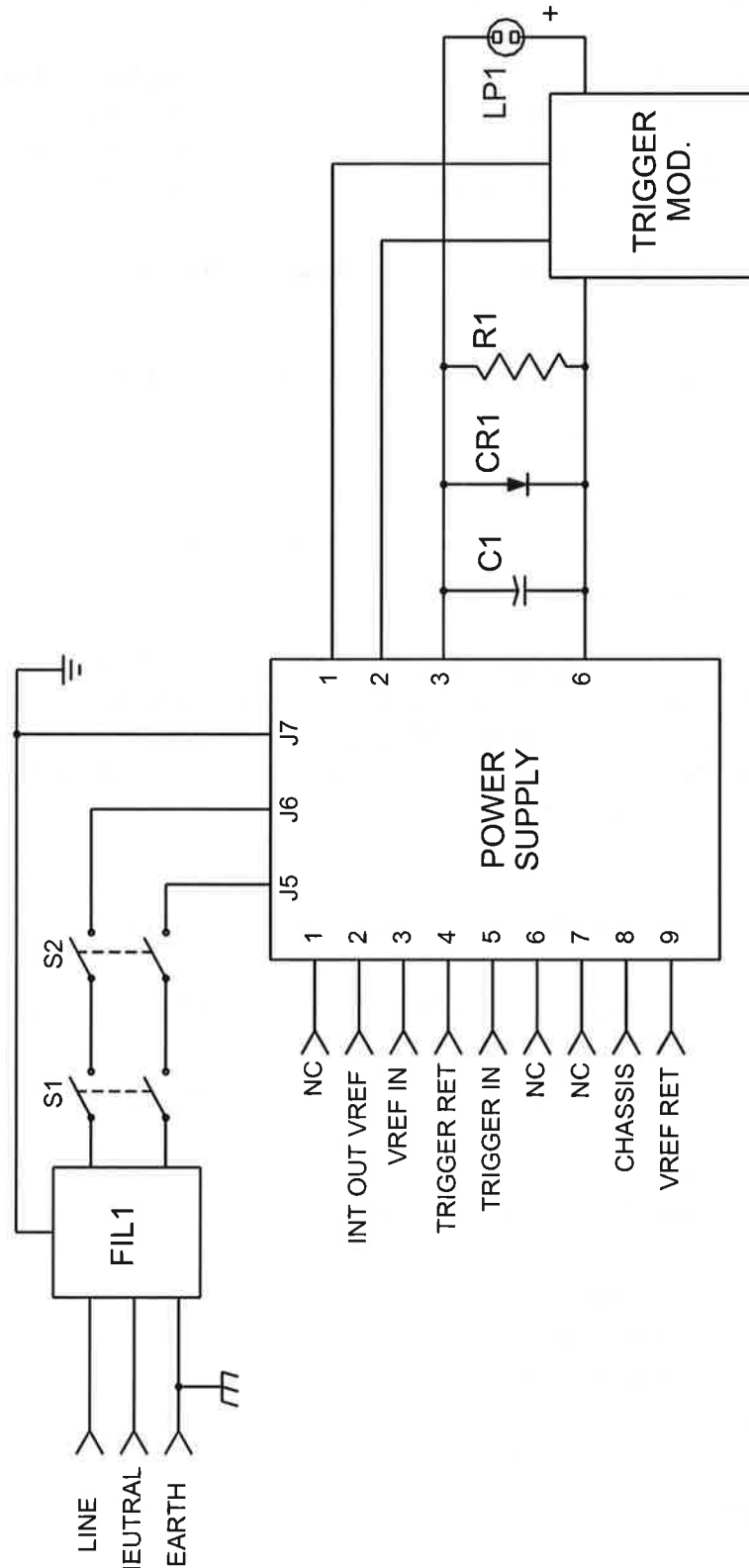

Figure 4. Simplified Schematic

6.0 DECLARATION OF CONFORMITY

MANUFACTURER:
Excelitas Technologies Corp.
35 Congress Street
Salem, Massachusetts 01970 U.S.A.

EUROPEAN REPRESENTATIVE
Excelitas Technologies GmbH:
Wenzel-Jaksch-Str. 31
D-65199 Wiesbaden Germany

Part Number	Model Number	Product Description
302-2027	MVS-2027	Machine Vision Strobe (20Hz, 12uF, 600V)
302-2027-03	MVS-2027-03	
302-2027-08	MVS-2027-UV	
302-2067	MVS-2067	Machine Vision Strobe (60Hz, 4uF, 600V)
302-2067-03	MVS-2067-03	
302-2067-04	MVS-2067-04	

We, Excelitas Technologies Corp., at 35 Congress Street, Salem, Massachusetts, U.S.A., declare that the product described above is in conformity with **EU EMC Directive 89/336/EEC Essential Health and Safety Requirements Relating to Electromagnetic Compatibility** using the relevant sections of the following standards and other normative documents:

- EN50082-1 (1997)
Generic Immunity Standard; Residential, Commercial, and Light Industrial Equipment
- EN50082-2 (1995)
Generic Immunity Standard; Industrial, Scientific, and Medical Equipment
- EN55011 (1991) Class B, Group 1
Radiated and Conducted Electronic Emissions for Industrial, Scientific, and Medical Equipment
- EN55022 Class B (1995)
Radiated and Conducted Electromagnetic Emissions
- EN61000-4-2 (1996)
Electrostatic Discharge Immunity
- EN61000-4-3 (1997) / ENV 50204 (1996)
Radiated Electromagnetic Field Immunity
- EN61000-4-4 (1995)
Electric Fast Transient Burst Immunity
- EN61000-4-5 (1995)
Surge Immunity

6.0 DECLARATION OF CONFORMITY

MANUFACTURER:
Excelitas Technologies Corp.
35 Congress Street
Salem, Massachusetts 01970 U.S.A.

EUROPEAN REPRESENTATIVE
Excelitas Technologies GmbH:
Wenzel-Jaksch-Str. 31
D-65199 Wiesbaden Germany

Part Number	Model Number	Product Description
302-2027	MVS-2027	Machine Vision Strobe (20Hz, 12uF, 600V)
302-2027-03	MVS-2027-03	
302-2027-08	MVS-2027-UV	
302-2067	MVS-2067	Machine Vision Strobe (60Hz, 4uF, 600V)
302-2067-03	MVS-2067-03	
302-2067-04	MVS-2067-04	

We, Excelitas Technologies Corp., at 35 Congress Street, Salem, Massachusetts, U.S.A., declare that the product described above is in conformity with **EU EMC Directive 89/336/EEC Essential Health and Safety Requirements Relating to Electromagnetic Compatibility** using the relevant sections of the following standards and other normative documents:

- EN50082-1 (1997)
Generic Immunity Standard; Residential, Commercial, and Light Industrial Equipment
- EN50082-2 (1995)
Generic Immunity Standard; Industrial, Scientific, and Medical Equipment
- EN55011 (1991) Class B, Group 1
Radiated and Conducted Electronic Emissions for Industrial, Scientific, and Medical Equipment
- EN55022 Class B (1995)
Radiated and Conducted Electromagnetic Emissions
- EN61000-4-2 (1996)
Electrostatic Discharge Immunity
- EN61000-4-3 (1997) / ENV 50204 (1996)
Radiated Electromagnetic Field Immunity
- EN61000-4-4 (1995)
Electric Fast Transient Burst Immunity
- EN61000-4-5 (1995)
Surge Immunity

- EN61000-4-6 (1995)
Radio-Frequency Common Mode Immunity
- EN61000-4-8 (1994)
Power-Frequency Magnetic Field Immunity
- EN61000-4-11 (1994)
Voltage Dip and Interrupt Immunity
- ENV5140 (1994)
Radiated Electromagnetic Field Immunity

This product also complies with **EU Low Voltage Directive 73/23/EEC** using the relevant sections of the following standards and other normative documents:

- EN61010-1: 1993
Safety requirements for electrical equipment for measurement, controls and laboratory use.

This product has been manufactured in compliance with Excelitas Technologies Corp. I.S. EN ISO 9001: 2008, Quality System, Registration Number M1312.



Stewart Tuttle, Quality Assurance