



18-Bit, Single-Channel, Ultra-Low Power, Delta-Sigma ADC with 2-Wire Serial Interface

General Description

The MAX11212 is an ultra-low power (< 300 μ A max active current), high-resolution, serial-output ADC. This device provides the highest resolution per unit power in the industry, and is optimized for applications that require very high dynamic range with low power such as sensors on a 4mA to 20mA industrial control loop. The MAX11212 provides a high-accuracy internal oscillator that requires no external components.

When used with the specified data rates, the internal digital filter provides more than 80dB rejection of 50Hz or 60Hz line noise. The MAX11212 provides a simple 2-wire serial interface in the space-saving, 10-pin μ MAX[®] package. The MAX11212 operates over the -40°C to +85°C temperature range.

Applications

Sensor Measurement (Temperature and Pressure)
 Portable Instrumentation
 Battery Applications
 Weigh Scales

Features

- ◆ 18-Bit Full-Scale Resolution
- ◆ 720nVRMS Noise (MAX11212B)
- ◆ 3ppm INL
- ◆ No Missing Codes
- ◆ Ultra-Low-Power Dissipation
 Operating-Mode Current Drain < 300 μ A (max)
 Sleep-Mode Current Drain < 0.1 μ A
- ◆ 2.7V to 3.6V Analog Supply Voltage Range
- ◆ 1.7V to 3.6V Digital and I/O Supply Voltage Range
- ◆ Fully Differential Signal Inputs
- ◆ Fully Differential Reference Inputs
- ◆ Internal System Clock
 2.4576MHz (MAX11212A)
 2.2528MHz (MAX11212B)
- ◆ External Clock
- ◆ Serial 2-Wire Interface (Clock Input and Data Output)
- ◆ On-Demand Offset and Gain Self-Calibration
- ◆ -40°C to +85°C Operating Temperature Range
- ◆ \pm 2kV ESD Protection
- ◆ Lead(Pb)-Free and RoHS-Compliant μ MAX Package

Ordering Information

PART	PIN-PACKAGE	OUTPUT RATE (sps)
MAX11212AEUB+*	10 μ MAX	120
MAX11212BEUB+	10 μ MAX	13.75

Note: All devices are specified over the -40°C to +85°C operating temperature range.

+Denotes a lead(Pb)-free/RoHS-compliant package.

*Future product—contact factory for availability.

Selector Guide

RESOLUTION (BITS)	4-WIRE SPI, 16-PIN QSOP, PROGRAMMABLE GAIN	4-WIRE SPI, 16-PIN QSOP	2-WIRE SERIAL, 10-PIN μ MAX
24	MAX11210	MAX11200	MAX11201 (with buffers) MAX11202 (without buffers)
20	MAX11206	MAX11207	MAX11208
18	MAX11209	MAX11211	MAX11212
16	MAX11213	MAX11203	MAX11205

μ MAX is a registered trademark of Maxim Integrated Products, Inc.



18-Bit, Single-Channel, Ultra-Low Power, Delta-Sigma ADC with 2-Wire Serial Interface

ABSOLUTE MAXIMUM RATINGS

Any Pin to GND	-0.3V to +3.9V
AVDD to GND.....	-0.3V to +3.9V
DVDD to GND	-0.3V to +3.9V
Analog Inputs (AINP, AINN, REFP, REFN) to GND	-0.3V to (V _{AVDD} + 0.3V)
Digital Inputs and Digital Outputs to GND	-0.3V to (V _{DVDD} + 0.3V)
ESD _{HB} (AVDD, AINP, AINN, REFP, REFN, DVDD, CLK, SCLK, RDY/DOUT, GND)	±2kV (Note 1)

Continuous Power Dissipation (T _A = +70°C) 10-Pin μ MAX (derate 5.6mW/°C above +70°C).....	444mW
Operating Temperature Range	-40°C to +85°C
Junction Temperature	+150°C
Storage Temperature Range.....	-55°C to +150°C
Lead Temperature (soldering, 10s)	+300°C
Soldering Temperature (reflow)	+260°C

Note 1: Human Body Model to specification MIL-STD-883 Method 3015.7.

Stresses beyond those listed under "Absolute Maximum Ratings" may cause permanent damage to the device. These are stress ratings only, and functional operation of the device at these or any other conditions beyond those indicated in the operational sections of the specifications is not implied. Exposure to absolute maximum rating conditions for extended periods may affect device reliability.

ELECTRICAL CHARACTERISTICS

(V_{AVDD} = +3.6V, V_{DVDD} = +1.8V, V_{REFP} - V_{REFN} = V_{AVDD}; internal clock, T_A = T_{MIN} to T_{MAX}, unless otherwise noted. Typical values are at T_A = +25°C under normal conditions, unless otherwise noted.)

PARAMETER	SYMBOL	CONDITIONS	MIN	TYP	MAX	UNITS
ADC PERFORMANCE						
Noise-Free Resolution	NFR	(Notes 2, 3)		18		Bits
Thermal Noise (Notes 2, 3)	V _N	MAX11212A		2.1		μ V _{RMS}
		MAX11212B		0.72		
Integral Nonlinearity	INL	(Note 4)	-10		+10	ppmFSR
Zero Error	V _{OFF}	After calibration, V _{REFP} - V _{REFN} = 2.5V	-20	1	+20	ppmFSR
Zero Drift				50		nV/°C
Full-Scale Error		After calibration, V _{REFP} - V _{REFN} = 2.5V (Note 5)	-35	3	+35	ppmFSR
Full-Scale Error Drift			0.05			ppmFSR/°C
Power-Supply Rejection		AVDD DC rejection	70	80		dB
		DVDD DC rejection	90	100		
ANALOG INPUTS/REFERENCE INPUTS						
Common-Mode Rejection	CMR	DC rejection	90	123		dB
		50Hz/60Hz rejection MAX11212A	90			
		50Hz/60Hz rejection MAX11212B	144			
Normal-Mode 50Hz Rejection	NMR ₅₀	MAX11212B (Note 6)	65	80.5		dB
Normal-Mode 60Hz Rejection	NMR ₆₀	MAX11212B (Note 6)	73	87		dB
Common-Mode Voltage Range			GND		V _{AVDD}	V
Absolute Input Voltage		Low input voltage		GND - 30mV		V
		High input voltage		V _{AVDD} + 30mV		
DC Input Leakage		Sleep mode (Note 2)		±1		μ A
AIN Dynamic Input Current				5		μ A
REF Dynamic Input Current				7.5		μ A
AIN Input Capacitance				10		pF

18-Bit, Single-Channel, Ultra-Low Power, Delta-Sigma ADC with 2-Wire Serial Interface

ELECTRICAL CHARACTERISTICS (continued)

($V_{AVDD} = +3.6V$, $V_{DVDD} = +1.8V$, $V_{REFP} - V_{REFN} = V_{AVDD}$; internal clock, $T_A = T_{MIN}$ to T_{MAX} , unless otherwise noted. Typical values are at $T_A = +25^\circ C$ under normal conditions, unless otherwise noted.)

PARAMETER	SYMBOL	CONDITIONS	MIN	TYP	MAX	UNITS
REF Input Capacitance				15		pF
AIN Voltage Range		$V_{AINP} - V_{AINN}$	$-V_{REF}$		$+V_{REF}$	V
REF Voltage Range					V_{AVDD}	V
Input Sampling Rate	f_S	MAX11212A		246		kHz
		MAX11212B		225		
REF Sampling Rate		MAX11212A		246		kHz
		MAX11212B		225		
LOGIC INPUTS (SCLK, CLK)						
Input Current		Input leakage current		± 1		μA
Input Low Voltage	V_{IL}				$0.3 \times V_{DVDD}$	V
Input High Voltage	V_{IH}		$0.7 \times V_{DVDD}$			V
Input Hysteresis	V_{HYS}			200		mV
External Clock		MAX11212A		2.4576		MHz
		MAX11212B		2.2528		
LOGIC OUTPUTS ($\overline{RDY}/DOUT$)						
Output Low Level	V_{OL}	$I_{OL} = 1mA$; also tested for $V_{DVDD} = 3.6V$			0.4	V
Output High Level	V_{OH}	$I_{OH} = 1mA$; also tested for $V_{DVDD} = 3.6V$	$0.9 \times V_{DVDD}$			V
Floating State Leakage Current		Output leakage current		± 10		μA
Floating State Output Capacitance				9		pF
POWER REQUIREMENTS						
Analog Supply Voltage	AVDD		2.7		3.6	V
Digital Supply Voltage	DVDD		1.7		3.6	V
Total Operating Current		AVDD + DVDD		230	300	μA
DVDD Operating Current				45	60	μA
AVDD Operating Current				185	245	μA
AVDD Sleep Current				0.4	2	μA
DVDD Sleep Current				0.35	2	μA
2-WIRE SERIAL-INTERFACE TIMING CHARACTERISTICS						
SCLK Frequency	f_{SCLK}				5	MHz
SCLK Pulse Width Low	t_1	60/40 duty cycle 5MHz clock	80			ns
SCLK Pulse Width High	t_2	40/60 duty cycle 5MHz clock	80			ns
SCLK Rising Edge to Data Valid Transition Time	t_3				40	ns

18-Bit, Single-Channel, Ultra-Low Power, Delta-Sigma ADC with 2-Wire Serial Interface

ELECTRICAL CHARACTERISTICS (continued)

($V_{AVDD} = +3.6V$, $V_{DVDD} = +1.8V$, $V_{REFP} - V_{REFN} = V_{AVDD}$; internal clock, $T_A = T_{MIN}$ to T_{MAX} , unless otherwise noted. Typical values are at $T_A = +25^\circ C$ under normal conditions, unless otherwise noted.)

PARAMETER	SYMBOL	CONDITIONS	MIN	TYP	MAX	UNITS
SCLK Rising Edge Data Hold Time	t_4	Allows for positive edge data read	3			ns
RDY/DOUT Fall to SCLK Rising Edge	t_5		0			ns
Next Data Update Time; No Read Allowed	t_6	MAX11212A		155		μs
		MAX11212B		169		
Data Conversion Time	t_7	MAX11212A		8.6		ms
		MAX11212B		73		
Data Ready Time After Calibration Starts (CAL + CNV)	t_8	MAX11212A		208.3		ms
		MAX11212B		256.1		
SCLK High After RDY/DOUT Goes Low to Activate Sleep Mode	t_9	MAX11212A	0		8.6	ms
		MAX11212B	0		73	
Time From RDY/DOUT Low to SCLK High for Sleep Mode Activation	t_{10}	MAX11212A	0		8.6	ms
		MAX11212B	0		73	
Data Ready Time After Wake-Up from Sleep Mode	t_{11}	MAX11212A		8.6		ms
		MAX11212B		73		
Data Ready Time After Calibration from Sleep Mode Wake-Up (CAL + CNV)	t_{12}	MAX11212A		208.4		ms
		MAX11212B		256.2		

Note 2: These specifications are not fully tested and are guaranteed by design and/or characterization.

Note 3: $V_{AINP} = V_{AINN}$.

Note 4: ppmFSR is parts per million of full-scale range.

Note 5: Positive full-scale error includes zero-scale errors.

18-Bit, Single-Channel, Ultra-Low Power, Delta-Sigma ADC with 2-Wire Serial Interface

Typical Operating Characteristics

($V_{AVDD} = 3.6V$, $V_{DVDD} = 1.8V$, $V_{REFP} - V_{REFN} = V_{AVDD}$; internal clock; $T_A = T_{MIN}$ to T_{MAX} , unless otherwise noted. Typical values are at $T_A = +25^\circ C$.)

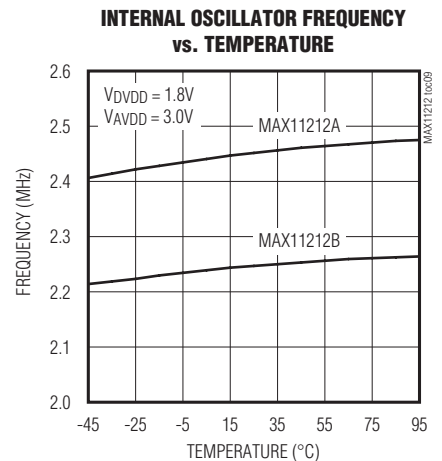
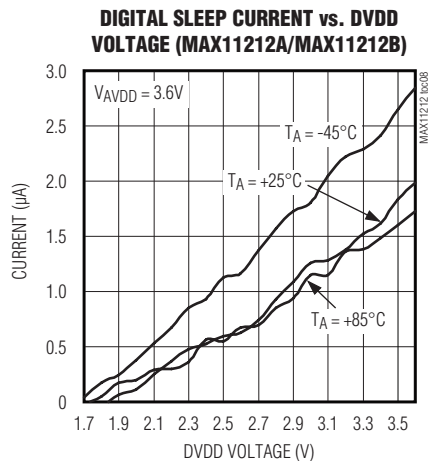
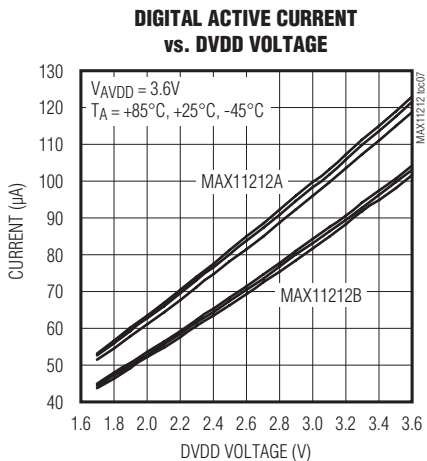
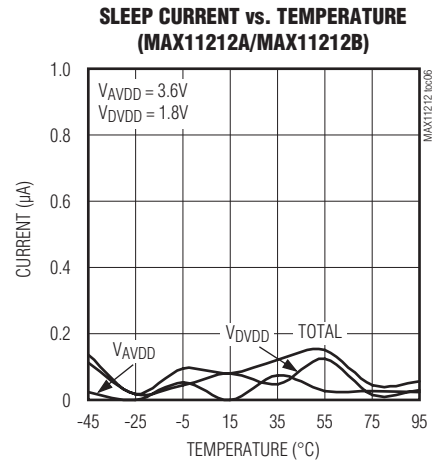
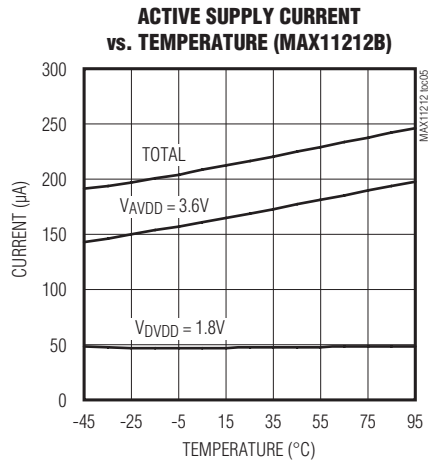
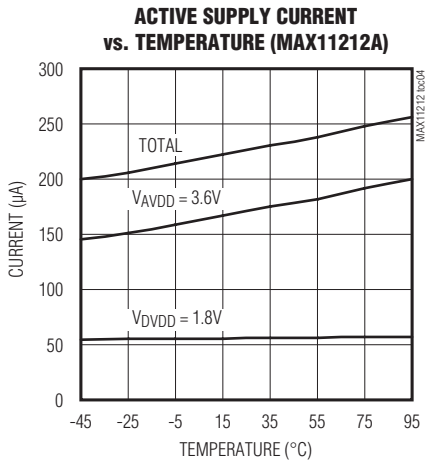
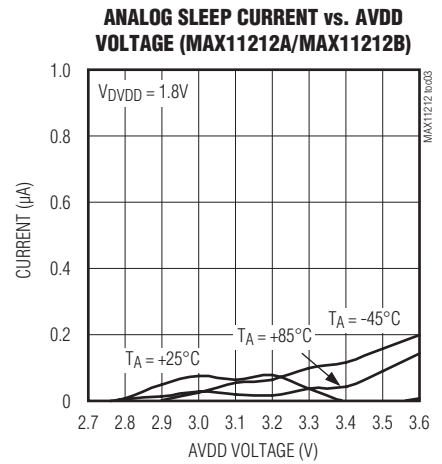
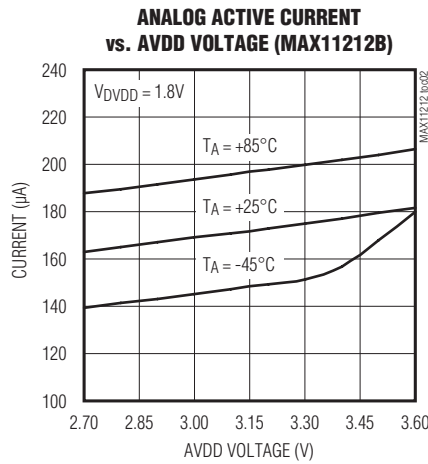
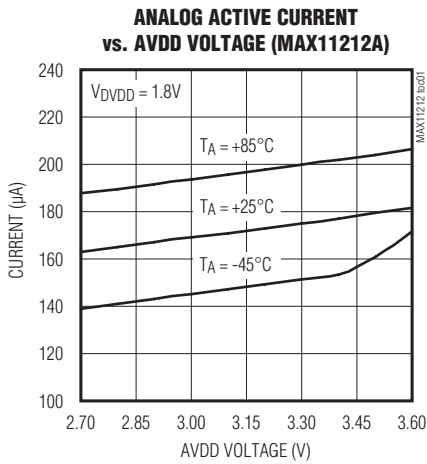

18-Bit, Single-Channel, Ultra-Low Power, Delta-Sigma ADC with 2-Wire Serial Interface

Typical Operating Characteristics (continued)

($V_{AVDD} = 3.6V$, $V_{DVDD} = 1.8V$, $V_{REFP} - V_{REFN} = V_{AVDD}$; internal clock; $T_A = T_{MIN}$ to T_{MAX} , unless otherwise noted. Typical values are at $T_A = +25^\circ C$.)

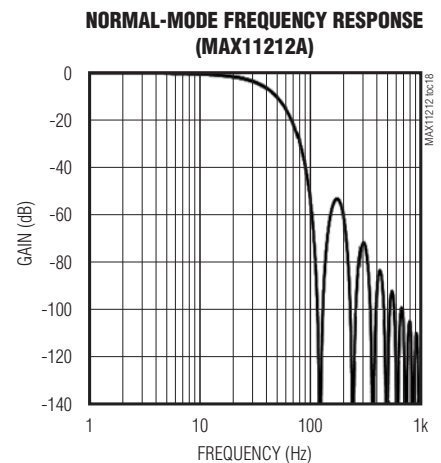
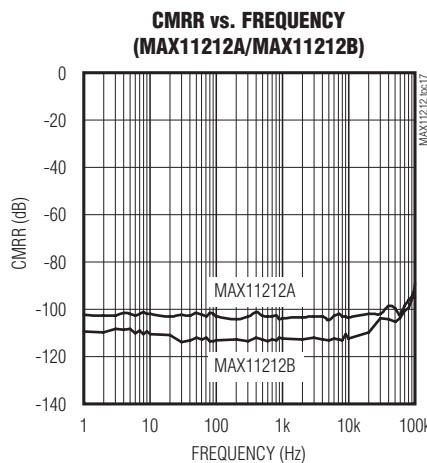
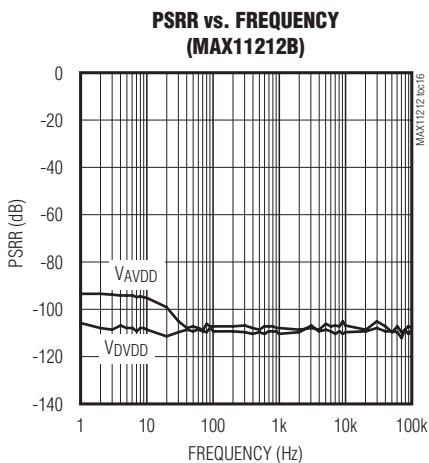
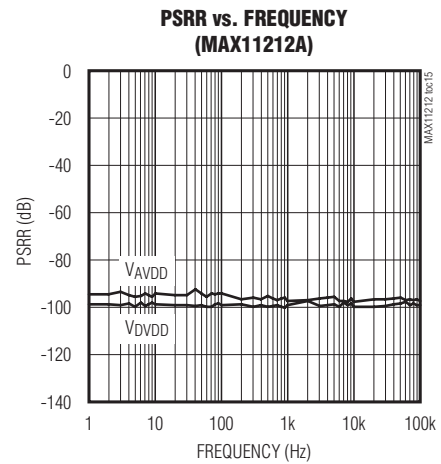
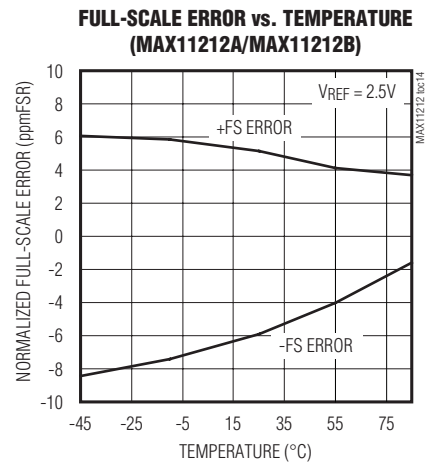
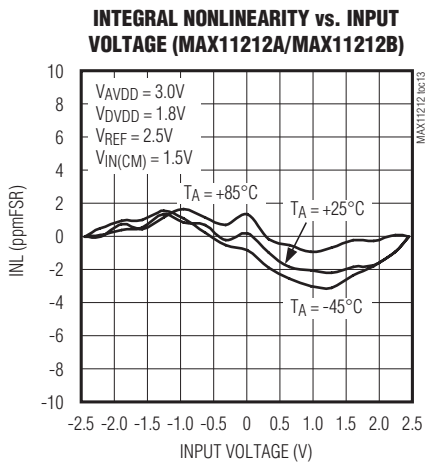
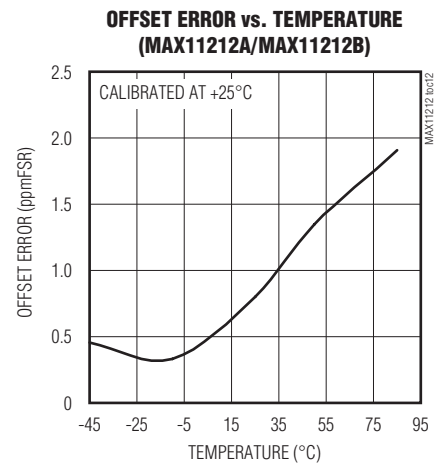
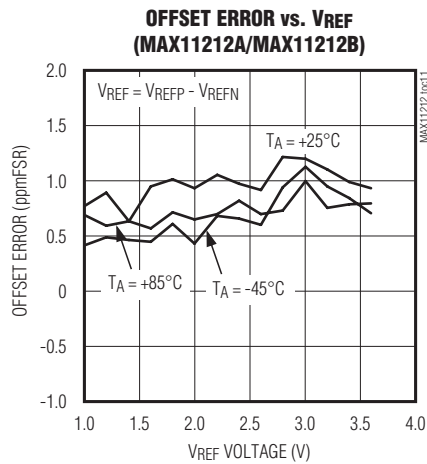
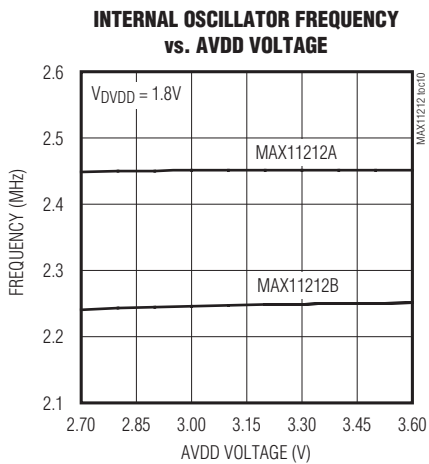

18-Bit, Single-Channel, Ultra-Low Power, Delta-Sigma ADC with 2-Wire Serial Interface

Typical Operating Characteristics (continued)

($V_{AVDD} = 3.6V$, $V_{DVDD} = 1.8V$, $V_{REFP} - V_{REFN} = V_{AVDD}$; internal clock; $T_A = T_{MIN}$ to T_{MAX} , unless otherwise noted. Typical values are at $T_A = +25^\circ C$.)

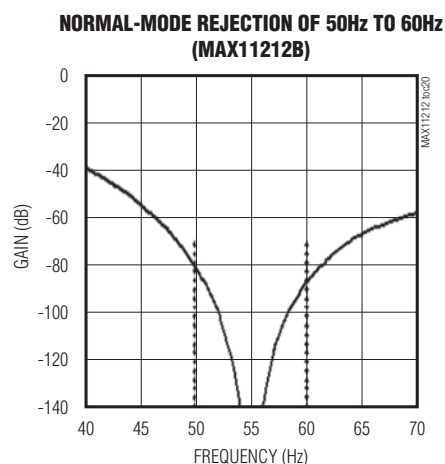
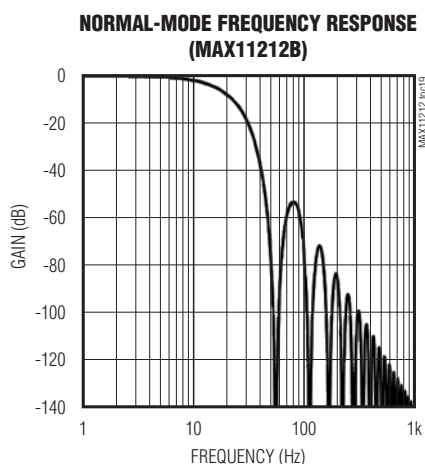

Functional Diagram

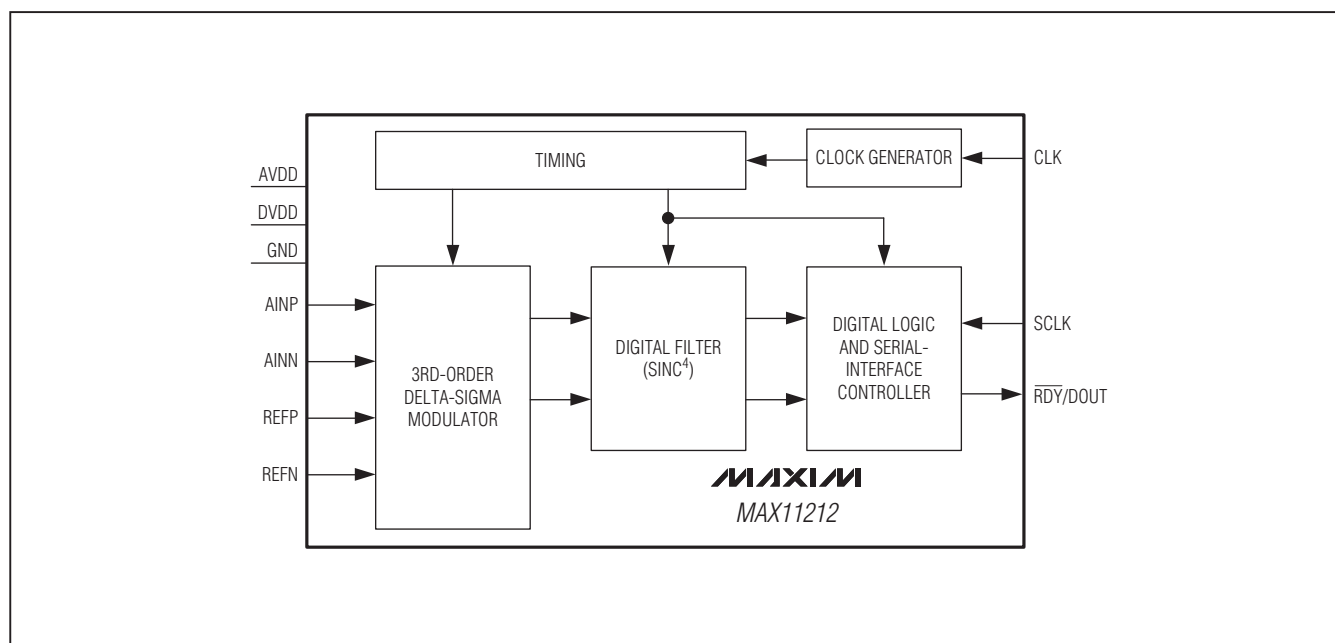

18-Bit, Single-Channel, Ultra-Low Power, Delta-Sigma ADC with 2-Wire Serial Interface

Pin Configuration

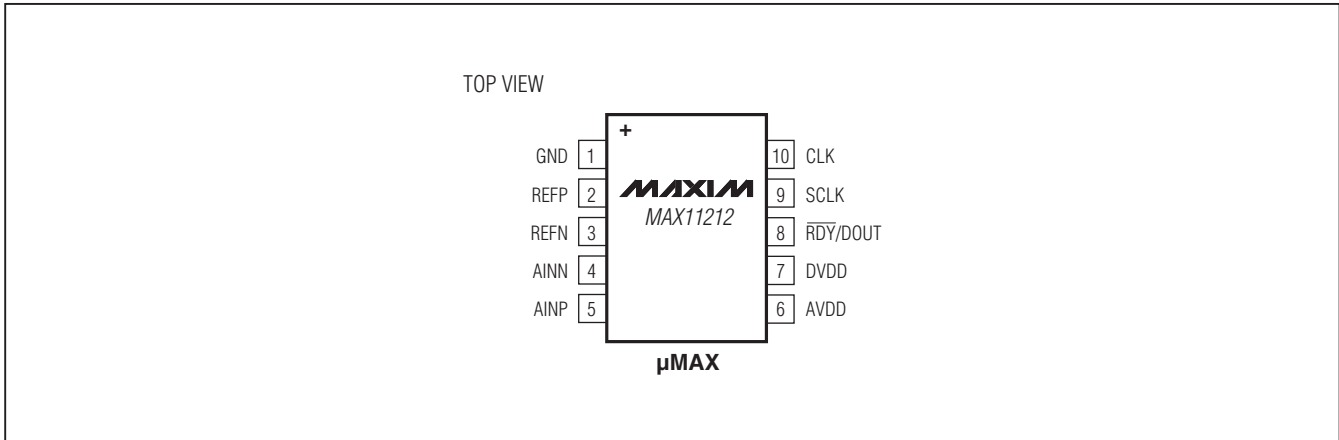

Pin Description

PIN	NAME	FUNCTION
1	GND	Ground. Ground reference for analog and digital circuitry.
2	REFP	Differential Reference Positive Input. REFP must be more positive than REFN. Connect REFP to a voltage between AVDD and GND.
3	REFN	Differential Reference Negative Input. REFN must be more negative than REFP. Connect REFN to a voltage between AVDD and GND.
4	AINN	Negative Fully Differential Analog Input
5	AINP	Positive Fully Differential Analog Input
6	AVDD	Analog Supply Voltage. Connect a supply voltage between +2.7V to +3.6V with respect to GND.
7	DVDD	Digital Supply Voltage. Connect a digital supply voltage between +1.7V to +3.6V with respect to GND.
8	RDY/DOUT	Data-Ready Output/Serial-Data Output. This output serves a dual function. In addition to the serial-data output function, the RDY/DOUT also indicates that the data is ready when the RDY is logic-low. RDY/DOUT changes on the falling edge of SCLK.
9	SCLK	Serial-Clock Input. Apply an external serial clock to SCLK.
10	CLK	External Clock Signal Input. The internal clock shuts down when CLK is driven by an external clock. Use a 2.4576MHz oscillator (MAX11212A) or a 2.2528MHz oscillator (MAX11212B).

18-Bit, Single-Channel, Ultra-Low Power, Delta-Sigma ADC with 2-Wire Serial Interface

Detailed Description

The MAX11212 is an ultra-low-power (< 240 μ A active), high-resolution, low-speed, serial-output ADC. This device provides the highest resolution per unit power in the industry, and is optimized for applications that require very high dynamic range with low power such as sensors on a 4mA to 20mA industrial control loop. The MAX11212 provides a high-accuracy internal oscillator, which requires no external components. When used with the specified data rates, the internal digital filter provides more than 80dB rejection of 50Hz or 60Hz line noise. The MAX11212 provides a simple, system-friendly, 2-wire serial interface in the space-saving, 10-pin μ MAX package.

Power-On Reset (POR)

The MAX11212 utilizes power-on reset (POR) supply-monitoring circuitry on both the digital supply (DVDD) and the analog supply (AVDD). The POR circuitry ensures proper device default conditions after either a digital or analog power-sequencing event.

The MAX11212 performs a self-calibration operation as part of the startup initialization sequence whenever a digital POR is triggered. It is important to have a stable reference voltage available at the REFP and REFN pins to ensure an accurate calibration cycle. If the reference voltage is not stable during a POR event, the part should be calibrated once the reference has stabilized. The part can be programmed for calibration by using 26 SCLKs as shown in Figure 3.

The digital POR trigger threshold is approximately 1.2V and has 100mV of hysteresis. The analog POR trigger threshold is approximately 1.25V and has 100mV of hysteresis. Both POR circuits have lowpass filters that prevent high-frequency supply glitches from triggering the POR. The analog supply (AVDD) and the digital supply (DVDD) pins should be bypassed using 0.1 μ F capacitors placed as close as possible to the package pin.

Analog Inputs

The MAX11212 accepts two analog inputs (AINP and AINN). The modulator input range is bipolar ($-V_{REF}$ to $+V_{REF}$).

Internal Oscillator

The MAX11212 incorporates a highly stable internal oscillator that provides the system clock. The system clock runs the internal state machine and is trimmed to

2.4576MHz (MAX11212A) or 2.2528MHz (MAX11212B). The internal oscillator clock is divided down to run the digital and analog timing.

Reference

The MAX11212 provides differential inputs REFP and REFN for an external reference voltage. Connect the external reference directly across REFP and REFN to obtain the differential reference voltage. The common-mode voltage range for V_{REFP} and V_{REFN} is between 0 and V_{AVDD} . The differential voltage range for REFP and REFN is 1V to V_{AVDD} .

Digital Filter

The MAX11212 contains an on-chip, digital lowpass filter that processes the 1-bit data stream from the modulator using a SINC⁴ ($\sin x/x$)⁴ response. When the device is operating in single-cycle conversion mode, the filter is reset at the end of the conversion cycle. When operating in continuous conversion latent mode, the filter is not reset. The SINC⁴ filter has a -3dB frequency equal to 24% of the data rate.

Serial-Digital Interface

The MAX11212 communicates through a 2-wire serial interface with a clock input and data output. The output rate is predetermined based on the package option (MAX11212A at 120sps and MAX11212B at 13.75sps).

2-Wire Interface

The MAX11212 is compatible with the 2-wire interface and uses SCLK and $\overline{RDY}/DOUT$ for serial communications. In this mode, all controls are implemented by timing the high or low phase of the SCLK. The 2-wire serial interface only allows for data to be read out through the $\overline{RDY}/DOUT$ output. Supply the serial clock to SCLK to shift the conversion data out.

The $\overline{RDY}/DOUT$ is used to signal data ready, as well as reading the data out when SCLK pulses are applied. $\overline{RDY}/DOUT$ is high by default. The MAX11212 pulls $\overline{RDY}/DOUT$ low when data is available at the end of conversion, and stays low until clock pulses are applied at SCLK input; on applying the clock pulses at SCLK, the $\overline{RDY}/DOUT$ outputs the conversion data on every SCLK positive edge. To monitor data availability, pull $\overline{RDY}/DOUT$ high after reading the 18 bits of data by supplying a 25th SCLK pulse.

The different operational modes using this 2-wire interface are described in the following sections.

18-Bit, Single-Channel, Ultra-Low Power, Delta-Sigma ADC with 2-Wire Serial Interface

Data Read Following Every Conversion

The MAX11212 indicates conversion data availability as well as allows the retrieval of data through the $\overline{\text{RDY}}/\text{DOUT}$ output. The $\overline{\text{RDY}}/\text{DOUT}$ output idles at the value of the last bit read unless a 25th SCLK pulse is provided, causing $\overline{\text{RDY}}/\text{DOUT}$ to idle high. $\overline{\text{RDY}}/\text{DOUT}$ is pulled low when the conversion data is available.

Figure 1 shows the timing diagram for the data read. Once a low is detected on $\overline{\text{RDY}}/\text{DOUT}$, clock pulses at SCLK clock out the data. Data is shifted out MSB first and is in binary two's complement format. Once all the data has been shifted out, a 25th SCLK is required to pull the $\overline{\text{RDY}}/\text{DOUT}$ output back to the idle high state. See Figure 2.

If the data is not read before the next conversion data is updated, the old data is lost, as the new data overwrites the old value.

Data Read Followed by Self-Calibration

To initiate self-calibration at the end of a data read, provide a 26th SCLK pulse. After reading the 16 bits of conversion data, a 25th positive edge on SCLK pulls the $\overline{\text{RDY}}/\text{DOUT}$ output back high, indicating end of data read. Provide a 26th SCLK pulse to initiate a self-calibration routine starting on the falling edge of the 26th SCLK. A subsequent falling edge of $\overline{\text{RDY}}/\text{DOUT}$ indicates data availability at the end of calibration. The timing is illustrated in Figure 3.

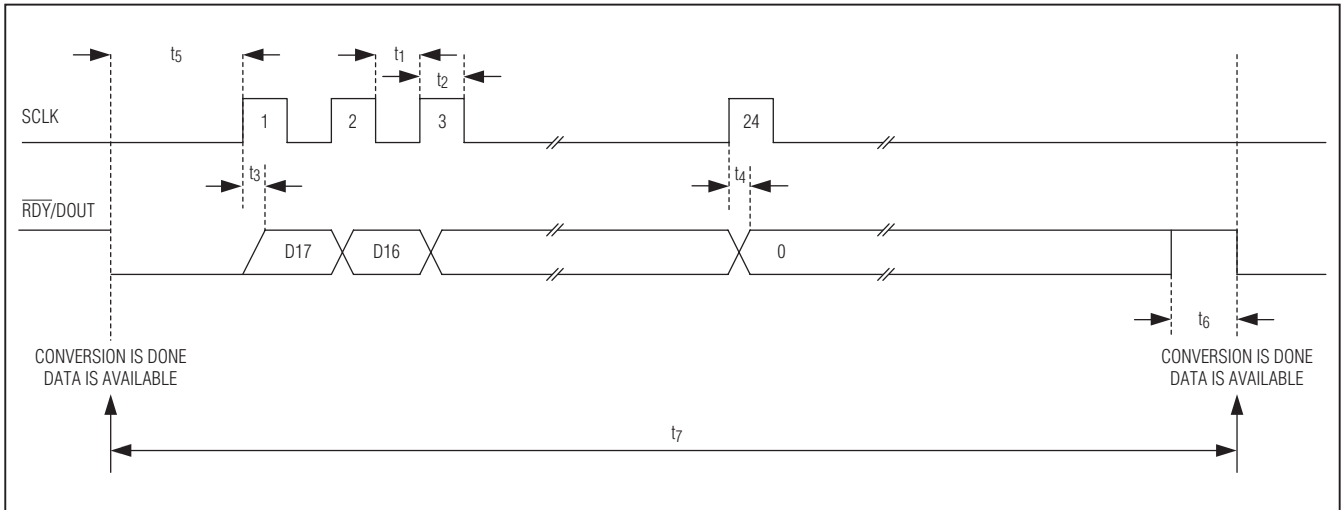

Figure 1. Timing Diagram for Data Read After Conversion

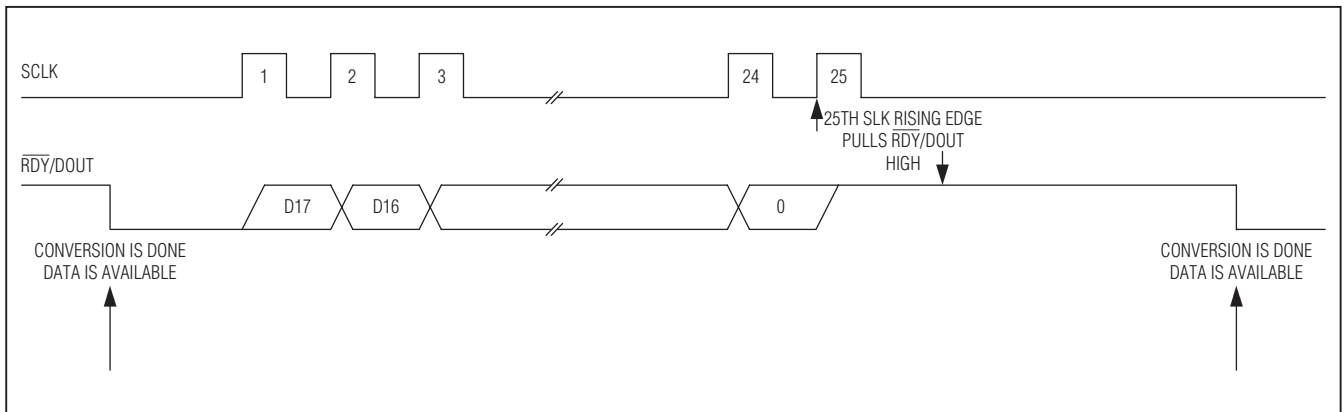

Figure 2. Timing Diagram for Data Read Followed by $\overline{\text{RDY}}/\text{DOUT}$ Being Asserted High Using 25th SCLK

18-Bit, Single-Channel, Ultra-Low Power, Delta-Sigma ADC with 2-Wire Serial Interface

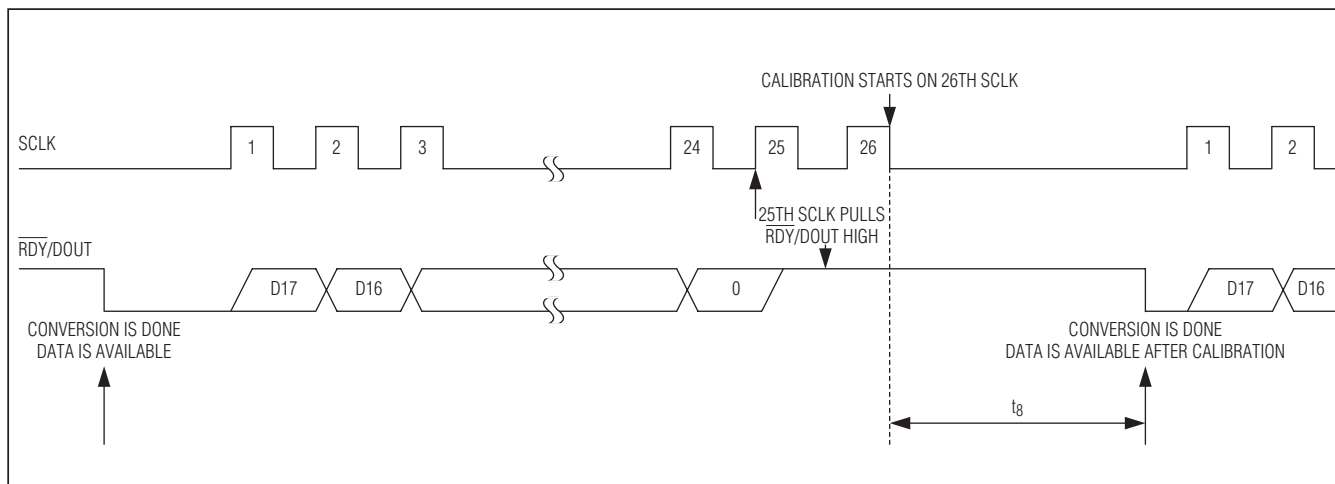

Figure 3. Timing Diagram for Data Read Followed by Two Extra Clock Cycles for Self-Calibration

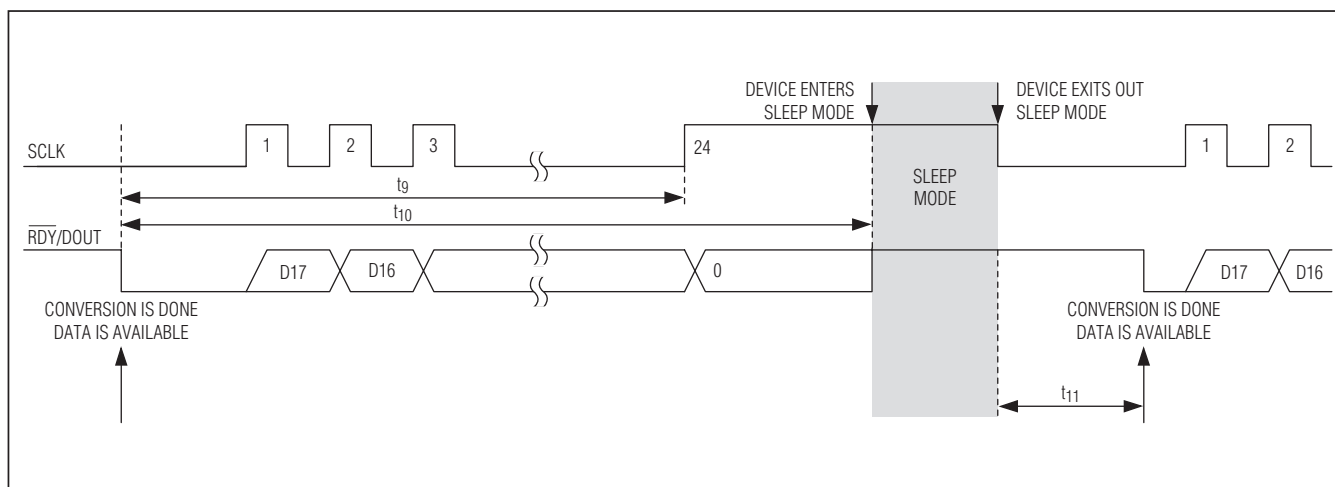

Figure 4. Timing Diagram for Data Read Followed by Sleep Mode Activation; Single-Conversion Timing

Data Read Followed by Sleep Mode

The MAX11212 can be put into sleep mode to save power between conversions. To activate the sleep mode, idle the SCLK high any time after the $\overline{\text{RDY}}/\text{DOUT}$ output goes low (that is, after conversion data is available). It is not required to read out all 18 bits before putting the part in sleep mode. Sleep mode is activated after the SCLK is held high (see Figure 4). The $\overline{\text{RDY}}/\text{DOUT}$ output is pulled high once the device enters sleep mode. To come out of sleep mode, pull SCLK low. After the sleep mode is deactivated (when the device wakes up), conversion

starts again and $\overline{\text{RDY}}/\text{DOUT}$ goes low, indicating the next conversion data is available. See Figure 4.

Single-Conversion Mode

For operating the MAX11212 in single-conversion mode, activate and deactivate sleep mode between conversions as described in the *Data Read Followed by Sleep Mode* section). Single-conversion mode reduces power consumption by shutting down the device when idle between conversions. See Figure 4.

Single-Conversion Mode with

18-Bit, Single-Channel, Ultra-Low Power, Delta-Sigma ADC with 2-Wire Serial Interface

Self-Calibration at Wake-Up

The MAX11212 can be put in self-calibration mode immediately after wake-up from sleep mode. Self-calibration at wake-up helps to compensate for temperature or supply changes if the device is shut down for extensive periods. To automatically start self-calibration at the end of sleep mode, all the data bits must be shift-

ed out followed by 25th SCLK edge to pull $\overline{\text{RDY}}/\text{DOUT}$ high, and then on the 26th SCLK keep it high for as long as shutdown is desired. Once SCLK is pulled back low, the device automatically performs a self-calibration and, when the data is ready, the $\overline{\text{RDY}}/\text{DOUT}$ output goes low. See Figure 5. This also achieves the purpose of single conversions with self-calibration.

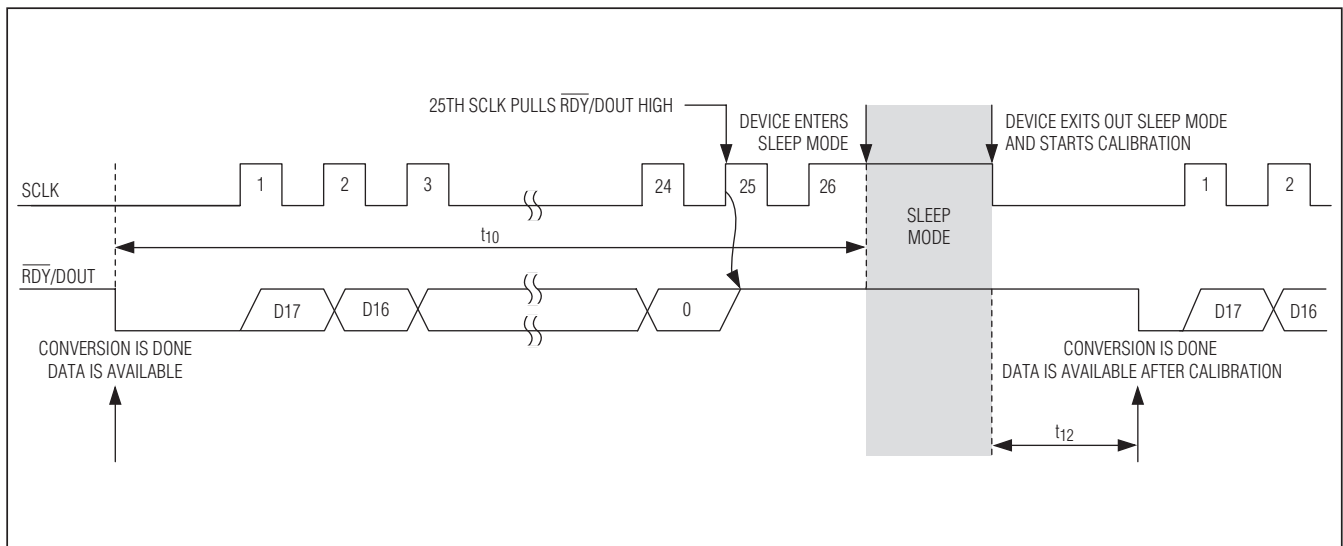

Figure 5. Timing Diagram for Sleep Mode Activation Followed by Self-Calibration at Wake-Up

18-Bit, Single-Channel, Ultra-Low Power, Delta-Sigma ADC with 2-Wire Serial Interface

Applications Information

See Figure 6 for the RTD temperature measurement circuit and Figure 7 for a resistive bridge measurement circuit.

Chip Information

PROCESS: BiCMOS

Package Information

For the latest package outline information and land patterns, go to www.maxim-ic.com/packages. Note that a "+", "#", or "-" in the package code indicates RoHS status only. Package drawings may show a different suffix character, but the drawing pertains to the package regardless of RoHS status.

PACKAGE TYPE	PACKAGE CODE	DOCUMENT NO.
10 μMAX	U10+2	21-0061

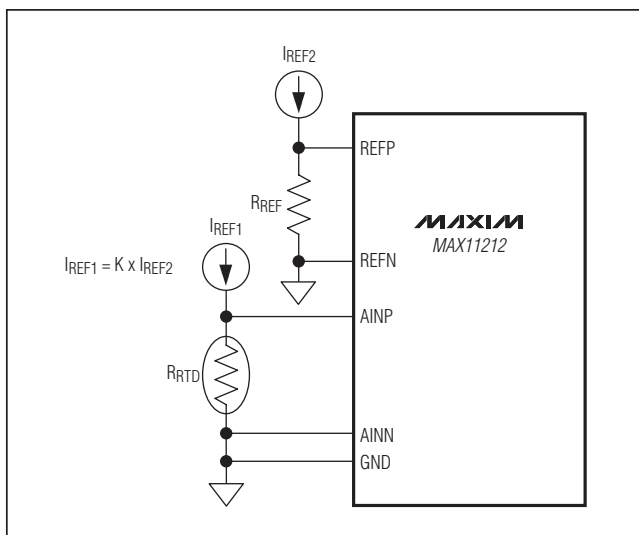

Figure 6. RTD Temperature Measurement Circuit

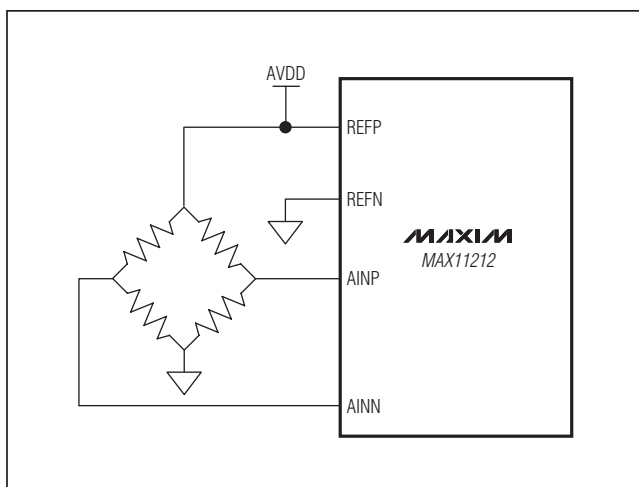

Figure 7. Resistive Bridge Measurement Circuit

18-Bit, Single-Channel, Ultra-Low Power, Delta-Sigma ADC with 2-Wire Serial Interface

Revision History

REVISION NUMBER	REVISION DATE	DESCRIPTION	PAGES CHANGED
0	4/10	Initial release	—

Maxim cannot assume responsibility for use of any circuitry other than circuitry entirely embodied in a Maxim product. No circuit patent licenses are implied. Maxim reserves the right to change the circuitry and specifications without notice at any time.

14 _____ **Maxim Integrated Products, 120 San Gabriel Drive, Sunnyvale, CA 94086 408-737-7600**